

# User Manual

## DA1458x/DA1468x Production Line Tool

### UM-B-041

#### **Abstract**

*This document describes the DA1458x/DA1468x Production Line Tool (PLT). The various software applications, as well as the PLT hardware are explained in detail. The purpose of this document is to help users to become familiar with the tool and help them use it in a short amount of time.*

---

---

**Contents**

<b>Abstract</b> .....	<b>1</b>
<b>Contents</b> .....	<b>2</b>
<b>Figures</b> .....	<b>5</b>
<b>Tables</b> .....	<b>7</b>
<b>1 Terms and Definitions</b> .....	<b>10</b>
<b>2 References</b> .....	<b>12</b>
<b>3 New version features</b> .....	<b>13</b>
<b>4 Introduction</b> .....	<b>14</b>
<b>5 Hardware</b> .....	<b>15</b>
5.1 Hardware Block Diagram .....	15
5.2 Printed Circuit Board Layout .....	16
5.3 PLT Power Supply .....	16
5.4 DUT Connector .....	17
5.5 Data Streaming .....	18
5.6 Golden Unit .....	20
5.6.1 GU Reset .....	20
5.7 Current Measurements .....	21
5.8 Jumper Settings .....	21
5.8.1 J26 - Current Measurements .....	22
5.8.2 J42 - DA1458x OTP Burning Voltage .....	22
5.8.3 J47, J46 - GU Reset .....	23
5.8.4 J37 - GU Programming.....	23
5.9 PLT Functional Blocks .....	25
<b>6 Software</b> .....	<b>26</b>
6.1 Introduction .....	26
6.2 DA15100/1 support .....	27
6.3 Software Package Contents .....	27
6.4 Prerequisites .....	29
6.5 System Requirements.....	30
6.6 Limitations .....	30
6.7 Building the Code.....	31
6.8 Executing the Applications .....	32
6.9 Test Sequence .....	36
6.9.1 DA1458x Test Sequence .....	36
6.9.2 DA1468x Test Sequence .....	40
6.10 VBAT/Reset Signals Operation.....	44
6.10.1 VBAT Only .....	44
6.10.2 VBAT On with Reset.....	45
6.10.3 VBAT as Reset .....	45
6.11 Custom Memory Data .....	46
6.11.1 Homekit Hash Setup Code .....	46
6.11.2 Custom data CSV file format .....	48
6.12 Golden Unit Scan Test.....	49
6.13 Creating Firmware Files under “binaries” Folder .....	50

---



---

**DA1458x/DA1468x Production Line Tool**

<b>7 Applications</b> .....	<b>55</b>
7.1 Introduction .....	55
7.2 CFG PLT Application .....	55
7.2.1 XML and XSD Files .....	56
7.2.2 Hardware Setup .....	58
7.2.2.1 Station Identification .....	59
7.2.2.2 Device IC .....	59
7.2.2.3 Active DUTs .....	59
7.2.2.4 DUT COM Ports .....	60
7.2.2.5 Golden Unit Port Selection .....	60
7.2.2.6 VBAT/Reset Mode .....	61
7.2.3 General .....	61
7.2.3.1 Statistics .....	61
7.2.3.2 Test Options .....	62
7.2.4 BD Addresses .....	63
7.2.4.1 BD Address Assignment .....	63
7.2.5 UART (DA1458x) .....	65
7.2.5.1 UART Boot Pins Setup .....	65
7.2.5.2 UART Baud Rate .....	66
7.2.5.3 UART Programming GPIOs Setup .....	66
7.2.6 Test Settings (DA1458x) .....	67
7.2.6.1 XTAL Trim .....	67
7.2.6.2 RF Tests .....	68
7.2.6.3 Current Measurement Test .....	74
7.2.6.4 GPIO/LED Test .....	75
7.2.6.5 Audio Test .....	76
7.2.6.6 Sensor Test .....	77
7.2.6.7 Custom Test .....	78
7.2.6.8 Temperature Measurement Test .....	78
7.2.6.9 Scan Test .....	79
7.2.7 Memory Functions (DA1458x) .....	80
7.2.7.1 OTP Memory .....	80
7.2.7.2 SPI Flash Memory .....	81
7.2.7.3 I2C EEPROM Memory .....	83
7.2.7.4 Memory read .....	84
7.2.8 Memory Header (DA1458x) .....	85
7.2.8.1 General .....	85
7.2.8.2 BD Address .....	87
7.2.8.3 Custom Memory Data .....	88
7.2.9 UART (DA1468x) .....	89
7.2.9.1 UART Boot Pins Setup .....	89
7.2.9.2 UART Baud Rate .....	89
7.2.10 Test Settings (DA1468x) .....	90
7.2.10.1 XTAL Trim .....	90
7.2.10.2 RF Tests .....	90
7.2.10.3 Current Measurement Test .....	97
7.2.10.4 GPIO/LED Test .....	99

---

**DA1458x/DA1468x Production Line Tool**

---

7.2.10.5	Sensor Test .....	100
7.2.10.6	ADC Calibration (DA14681-00 AD only).....	101
7.2.10.7	Custom Test .....	102
7.2.10.8	Temperature Measurement Test.....	102
7.2.10.9	Scan Test.....	103
7.2.11	Memory Functions (DA1468x).....	104
7.2.11.1	OTP Memory .....	104
7.2.11.2	QSPI Flash Memory .....	105
7.2.11.3	Memory read.....	106
7.2.12	Memory Header (DA1468x).....	106
7.2.12.1	OTP Header.....	107
7.2.12.2	OTP Header - BD Address .....	108
7.2.12.3	OTP Header - XTAL Trim .....	109
7.2.12.4	QSPI Header - BD Address.....	110
7.2.12.5	QSPI Header - XTAL Trim.....	110
7.2.12.6	Custom Memory Data.....	111
7.2.13	Debug Settings .....	112
7.2.14	Security .....	113
7.3	GUI PLT Application.....	113
7.3.1	GUI PLT Settings.....	116
7.3.2	Barcode Scanner Mode.....	117
7.3.2.1	Homekit setup code scan example.....	119
7.3.3	Running the GUI PLT and Executing Tests.....	124
7.3.4	Debug Console .....	126
7.3.5	DUT Log File.....	127
7.3.6	CSV File.....	128
7.4	CLI PLT Application .....	129
7.4.1	CLI Introduction .....	129
7.4.2	CLI Commands.....	129
7.4.3	Running the CLI and Executing Tests.....	131
7.4.4	Using CLI Commands as Arguments .....	134
<b>8</b>	<b>Example Usage.....</b>	<b>135</b>
	<b>Appendix A Top-view of PLT PCB Version D .....</b>	<b>142</b>
	<b>Appendix B Electrical Schematics .....</b>	<b>143</b>
	<b>Appendix C Hardware Modifications PLT Version D .....</b>	<b>147</b>
	<b>Appendix D Suggestions about Hardware and Cabling.....</b>	<b>149</b>
	<b>Appendix E Hex2Bin .....</b>	<b>152</b>
	<b>Appendix F Bin2Image.....</b>	<b>154</b>
	<b>Appendix G Automatic GU COM Port Find .....</b>	<b>155</b>
	<b>Appendix H Improving Cabling between PLT and DUTs.....</b>	<b>157</b>
	<b>Appendix I Settings for DA14583 Internal SPI Flash Memory.....</b>	<b>159</b>
	<b>Appendix J Settings for DA14586 Internal SPI Flash Memory.....</b>	<b>160</b>
	<b>Appendix K Honeywell Xenon 1900 Barcode Scanner Setup.....</b>	<b>161</b>
	<b>Appendix L Program the Golden Unit SPI Flash Memory .....</b>	<b>162</b>

**DA1458x/DA1468x Production Line Tool**

<b>Appendix M Connecting a Speaker to the Golden Unit for Audio Test .....</b>	<b>163</b>
<b>Appendix N FTDI Driver Removal and Installation .....</b>	<b>164</b>
<b>Appendix O DA1458x DK PRO Motherboard Connection .....</b>	<b>165</b>
<b>Appendix P DA1468x DK PRO Motherboard Connection .....</b>	<b>166</b>
<b>Appendix Q Connecting DUT with Battery Supply .....</b>	<b>167</b>
<b>Appendix R DUT Status Codes .....</b>	<b>168</b>
<b>Appendix S Golden Unit Status Codes .....</b>	<b>176</b>
<b>Revision History .....</b>	<b>179</b>

**Figures**

Figure 1: Production Line Tool Hardware.....	14
Figure 2: Production Line Tool Hardware Board Block Diagram .....	15
Figure 3: Top View of the PLT Hardware Board (Version C) .....	16
Figure 4: PLT Hardware Power Connections.....	16
Figure 5: Production Line Tool DUT Connections.....	17
Figure 6: CPLD UART Data Streams.....	18
Figure 7: CPLD XTAL Trim Pulse Data Stream .....	19
Figure 8: CPLD UART Loopback Data Stream .....	19
Figure 9: Golden Unit .....	20
Figure 10: GU Reset Circuit .....	21
Figure 11: VBAT DUT Current Measurement Setup.....	21
Figure 12: Connections for 'Floating Current' Measurements.....	22
Figure 13: VPP Control Circuit Schematic .....	22
Figure 14: Location of the VPP Jumper J42.....	23
Figure 15: Location of J46 Jumper.....	23
Figure 16: Location of J47 Jumper .....	23
Figure 17: J37 - GU Programming Jumper Schematics .....	24
Figure 18: Location of J37 Jumper .....	24
Figure 19: PLT Functional Blocks .....	25
Figure 20: Production Line Tool Software Block Diagram .....	26
Figure 21: DA1458x/DA1468x PLT Software Package Contents .....	27
Figure 22: DA1458x Test Sequence .....	39
Figure 23: DA1468x Test Sequence .....	43
Figure 24: VBAT only .....	44
Figure 25: VBAT On with Reset .....	45
Figure 26: VBAT as Reset.....	45
Figure 27: Custom Memory Data CSV File Example .....	48
Figure 28: Golden Unit Scan Test .....	49
Figure 29: Golden Unit Scan Test Example Parameters .....	50
Figure 30: Binaries .....	51
Figure 31: "fw_files" Folder Contents .....	51
Figure 32: CFG PLT Startup Screen .....	55
Figure 33: CFG PLT with Erroneous Configuration Parameter.....	56
Figure 34: XSD Schema File Example .....	58
Figure 35: Station Identification.....	59
Figure 36: Device IC.....	59
Figure 37: Active DUTs .....	59
Figure 38: DUT COM Ports .....	60
Figure 39: Golden Unit COM Port .....	60
Figure 40: VBAT/Reset Mode Selection.....	61
Figure 41: Statistics .....	61
Figure 42: Test Options .....	62
Figure 43: BD Address Assignment .....	63
Figure 44: Example for Load from File Mode .....	64

---

**DA1458x/DA1468x Production Line Tool**

---

Figure 45: UART Boot Pins Setup - DA1458x.....	65
Figure 46: UART Baud Rate - DA1458x .....	66
Figure 47: UART Programming GPIOs Setup - DA1458x .....	66
Figure 48: XTAL Trim - DA1458x .....	67
Figure 49: Golden Unit RF Tests - DA1458x.....	68
Figure 50: BLE Tester General Settings - DA1458x .....	69
Figure 51: BLE Tester TX Power - DA1458x .....	69
Figure 52: BLE Tester Frequency Offset - DA1458x .....	70
Figure 53: BLE Tester Modulation Index - DA1458x.....	71
Figure 54: BLE Tester RX Sensitivity - DA1458x.....	72
Figure 55: Path Losses per DUT - DA1458x.....	73
Figure 56: Current Measurement Tests - DA1458x .....	74
Figure 57: GPIO/LED Tests - DA1458x .....	75
Figure 58: Audio Test .....	76
Figure 59: Sensor Test - DA1458x.....	77
Figure 60: Custom Test - DA1458x.....	78
Figure 61: Temperature Measurement Test - DA1458x .....	78
Figure 62: Scan Test - DA1458x.....	79
Figure 63: OTP Memory - DA1458x.....	80
Figure 64: Different Image per DUT Folder Example.....	81
Figure 65: SPI Flash Memory - DA1458x.....	81
Figure 66: I2C EEPROM Memory - DA1458x.....	83
Figure 67: Memory Read Test - DA1458x.....	84
Figure 68: OTP Header - DA1458x.....	85
Figure 69: BD Address - DA1458x.....	87
Figure 70: Custom Memory Data - DA1458x .....	88
Figure 71: UART Boot Pins Setup - DA1468x.....	89
Figure 72: UART Baud Rate - DA1468x .....	89
Figure 73: XTAL Trim - DA1468x .....	90
Figure 74: Golden Unit RF Tests - DA1468x.....	91
Figure 75: BLE Tester General Settings - DA1468x .....	92
Figure 76: BLE Tester TX Power - DA1468x .....	93
Figure 77: BLE Tester Frequency Offset - DA1468x .....	94
Figure 78: BLE Tester Modulation Index - DA1468x.....	95
Figure 79: BLE Tester RX Sensitivity - DA1468x.....	96
Figure 80: Path Losses per DUT - DA1468x.....	97
Figure 81: Current Measurement Tests - DA1468x .....	97
Figure 82: GPIO/LED Tests - DA1468x .....	99
Figure 83: Sensor Test - DA1468x.....	100
Figure 84: ADC Calibration - DA14681-00 (AD).....	101
Figure 85: Custom Test - DA1468x.....	102
Figure 86: Temperature Measurement Test - DA1468x .....	102
Figure 87: Scan Test - DA1468x.....	103
Figure 88: OTP Memory - DA1468x.....	104
Figure 89: QSPI Flash - DA1468x.....	105
Figure 90: Memory Read Test - DA1468x.....	106
Figure 91: OTP Header - DA1468x.....	107
Figure 92: OTP Header BD Address - DA1468x.....	108
Figure 93: OTP Header XTAL Trim - DA1468x.....	109
Figure 94: QSPI Header BD Address - DA1468x .....	110
Figure 95: QSPI Header XTAL Trim - DA14681-00 only .....	110
Figure 96: Custom Memory Data - DA1468x .....	111
Figure 97: Debug Settings.....	112
Figure 98: Security .....	113
Figure 99: GUI PLT Main Screen .....	114
Figure 100: GUI PLT Settings .....	116
Figure 101: Barcode Scan Option in GUI PLT .....	118
Figure 102: Barcode Scanner Controls .....	118
Figure 103: Barcode Scan - BD Address Assignment .....	118

**DA1458x/DA1468x Production Line Tool**

Figure 104: GUI PLT during Testing (1 of 2) .....	124
Figure 105: GUI PLT During Testing (2 of 2) .....	125
Figure 106: GUI PLT Tests Finished .....	125
Figure 107: GUI PLT Retry Failed DUTs Message .....	126
Figure 108: Debug Console .....	126
Figure 109: DUT Log File .....	127
Figure 110: CSV File .....	128
Figure 111: CLI Software Start Screen .....	129
Figure 112: CLI PLT Print Settings (x Command) .....	131
Figure 113: CLI PLT DUT COM Port Enumeration ('p' Command) .....	132
Figure 114: CLI PLT Read and Compare BD Address in QSPI ('v' Command) .....	133
Figure 115: CLI PLT During Testing .....	133
Figure 116: CLI PLT Testing Finished .....	133
Figure 117: CLI with Commands as Arguments .....	134
Figure 118: Top-view of PLT PCB Version D .....	142
Figure 119: VBAT and VPP Control from CPLD .....	143
Figure 120: CPLD DUT UART Connections .....	143
Figure 121: CPLD FTDI and GU Control Connections .....	144
Figure 122: FTDI Chip for USB UART to DUTs 1, 2, 3 and 4 .....	144
Figure 123: Quad USB HUB .....	145
Figure 124: Golden Unit - Dedicated USB Port and FTDI Chip .....	145
Figure 125: Golden Unit - GU LED and SPI Flash Memory .....	146
Figure 126: VBAT_DUT and VDDIO Supplies .....	146
Figure 127: GU Supply and VPP Generation .....	146
Figure 128: DA14580_RD_tester Version D .....	147
Figure 129: Jumper J47 Added Next to Golden Unit Socket .....	147
Figure 130: R365 (10 kΩ) Added Next to Reset Button .....	147
Figure 131: R365, J47 and RESET Shown in Electrical Schematic .....	148
Figure 132: Possible Solution of Antenna on Cable and Fixed Radius of DUTs to Antenna .....	149
Figure 133: Possible Solution of Antenna on Cable and DUTs Put in Line .....	150
Figure 134: Example Locations and RSSI Readouts of Horizontal Antenna .....	150
Figure 135: Hex2Bin Example Directory with Files .....	152
Figure 136: Hex2Bin.exe Example .....	153
Figure 137: Bin2Image Example Directory with Files .....	154
Figure 138: Bin2Image Example .....	154
Figure 139: Example of Twisted Pair Cable with 4 Pairs and Ferrite .....	157
Figure 140: Location of Pull-Down Resistors .....	157
Figure 141: Anti-Ringing Solution .....	158
Figure 142: Pin Assignment of DA14583 - QFN40 .....	159
Figure 143: Pin Assignment of DA14586 - QFN40 .....	160
Figure 144: Speaker Connection for Audio Test. ....	163

**Tables**

Table 1: DA1458x_DA1468x_PLT_v4.2 added features .....	13
Table 2: Power Supply Requirements .....	17
Table 3: PLT Connections to Applications .....	17
Table 4: Jumpers .....	21
Table 5: PLT User Interface Application Executables .....	26
Table 6: Executables Folder Description .....	27
Table 7: Production Line Tool Prerequisites .....	29
Table 8: Minimum System Requirements .....	30
Table 9: Opening the PLT Visual Studio 2015 Express Source Code Solution .....	31
Table 10: DA1458x_DA1468x_CFG_PLT.exe Application Execution .....	32
Table 11: DA1458x_DA1468x_GUI_PLT.exe Application Execution .....	35
Table 12: DA1458x_DA1468x_CLI_PLT.exe Application Execution .....	36
Table 13: DA1458x Test Sequence .....	36
Table 14: DA1468x Test Sequence .....	40



---

**DA1458x/DA1468x Production Line Tool**

---

Table 15: Custom Memory Data Input Modes.....	46
Table 16: Homekit Setup Code Format.....	47
Table 17: Homekit Setup Code Checksum Algorithm.....	47
Table 18: CFG PLT Main Menu Options.....	56
Table 19: CFG PLT Bottom Strip Options.....	56
Table 20: XML File Parts.....	57
Table 21: Station Identification.....	59
Table 22: Device IC.....	59
Table 23: Active DUTs.....	59
Table 24: DUT COM Ports.....	60
Table 25: Golden Unit COM Port.....	60
Table 26: VBAT/Reset Mode.....	61
Table 27: Statistics.....	61
Table 28: Test Options.....	62
Table 29: BD Address Assignment - Standard Mode.....	64
Table 30: BD Address Assignment Options - Range Mode.....	64
Table 31: BD Address Assignment Options - Load from File Mode.....	65
Table 32: BD Address Assignment Options - Scan Mode.....	65
Table 33: UART TX-RX Pins - DA1458x.....	66
Table 34: UART Baud Rate - DA1458x.....	66
Table 35: UART Programming GPIOs Setup - DA1458x.....	67
Table 36: XTAL Trim - DA1458x.....	67
Table 37: Golden Unit RF Tests - DA1458x.....	68
Table 38: BLE Tester General Settings - DA1458x.....	69
Table 39: BLE Tester TX Power - DA1458x.....	70
Table 40: BLE Tester Frequency Offset - DA1458x.....	70
Table 41: BLE Tester Modulation Index - DA1458x.....	71
Table 42: BLE Tester RX Sensitivity - DA1458x.....	72
Table 43: Path Losses per DUT from RF Tests DA1458x Options.....	73
Table 44: Current Measurement Tests - DA1458x.....	74
Table 45: Current Measurement for each Sleep State.....	75
Table 46: GPIO/LED Tests - DA1458x.....	76
Table 47: Audio Test.....	76
Table 48: Sensor Tests - DA1458x.....	77
Table 49: Custom Tests - DA1458x.....	78
Table 50: Temperature Measurement Test - DA1458x.....	78
Table 51: Scan Test DA1458x Options.....	79
Table 52: OTP Memory - DA1458x.....	80
Table 53: SPI Pin Setup - DA1458x.....	81
Table 54: SPI Flash Erase - DA1458x.....	82
Table 55: SPI Flash Image Write - DA1458x.....	82
Table 56: I2C Pin Setup - DA1458x.....	83
Table 57: I2C EEPROM Image Write - DA1458x.....	83
Table 58: Memory Read Test - DA1458x.....	84
Table 59: OTP Header - DA1458x.....	85
Table 60: BD Address - DA1458x.....	87
Table 61: Custom Memory Data - DA1458x.....	88
Table 62: UART TX-RX Pins - DA1468x.....	89
Table 63: UART Baud Rate - DA1468x.....	90
Table 64: XTAL Trim - DA1468x.....	90
Table 65: Golden Unit RF Tests - DA1468x.....	91
Table 66: BLE Tester General Settings - DA1468x.....	92
Table 67: BLE Tester TX Power - DA1468x.....	93
Table 68: BLE Tester Frequency Offset - DA1468x.....	94
Table 69: BLE Tester Modulation Index - DA1468x.....	95
Table 70: BLE Tester RX Sensitivity - DA1468x.....	96
Table 71: Path Losses per DUT from RF Tests DA1468x Options.....	97
Table 72: Current Measurement Tests - DA1458x.....	98
Table 73: Current Measurement for each Sleep State.....	98



---

**DA1458x/DA1468x Production Line Tool**

---

Table 74: GPIO/LED Tests - DA1468x.....	99
Table 75: Sensor Tests - DA1468x .....	100
Table 76: ADC Calibration - DA14681-00 (AD).....	101
Table 77: Custom Tests DA1468x Options .....	102
Table 78: Temperature Measurement Test - DA1468x.....	102
Table 79: Scan Test DA1468x Options .....	103
Table 80: OTP Memory - DA1468x .....	104
Table 81: QSPI Flash Erase - DA1468x.....	105
Table 82: QSPI Flash Image Write - DA1468x.....	105
Table 83: Memory Read Test - DA1468x.....	106
Table 84: General - OTP Header DA1468x Options .....	107
Table 85: OTP Header BD Address - DA1468x .....	108
Table 86: OTP Header XTAL Trim - DA1468x .....	109
Table 87: QSPI Header BD Address - DA1468x.....	110
Table 88: QSPI Header XTAL Trim - DA14681-00 only.....	110
Table 89: Custom Memory Data - DA1468x .....	111
Table 90: Debug Settings .....	113
Table 91: Security Options .....	113
Table 92: GUI PLT Main Screen Description .....	114
Table 93: GUI PLT Settings.....	116
Table 94: Homekit setup code scan example .....	119
Table 95: CLI Commands.....	129
Table 96: DA14580 PLT Example Usage .....	135
Table 97: RF Test RSSI Results .....	150
Table 98: FTDI "DialogSemi" Serial Number .....	155
Table 99: DA14583 Internal SPI Flash Connections.....	159
Table 100: DA14586 Internal SPI Flash Connections.....	160

---



---

**DA1458x/DA1468x Production Line Tool**

## 1 Terms and Definitions

API	Application Programming Interface
BD	Bluetooth Device
.bin	Firmware files in binary format
BLE	Bluetooth low energy
CFG	Configuration
CLI	Command Line Interface
COM	Communication port
CPLD	Complex Programmable Logic Device
CSV	Comma Separated Values
DLL	Dynamic Link Library
DMA	Direct Memory Access
DMM	Digital Multimeter
DTM	Direct Test Mode (as specified by the BLE Core standard)
DUT	Device Under Test
DVM	Digital Voltage Meter
EEPROM	Electrically Erasable Programmable Read-Only Memory
.exe	Executable file
FTDI	Future Technology Devices International Ltd.
GPIO	General Purpose Input-Output
GU	Golden Unit
GUI	Graphical User Interface
Hex	Firmware file in ASCII format
HW	hardware
IC	Integrated Circuit
IDE	Integrated Development Environment
I2C	Inter-Integrated Circuit
JTAG	Joint Test Action Group
OS	Operating System
OTP	One Time Programmable (memory)
PC	Personal Computer
PCB	Printed circuit board
PLT	Production Line Tool
PLTD	Production Line Tool DLL
RAM	Random Access Memory
RCX	Resistor Crystal Oscillator
RF	Radio Frequency
RX	Receive
SCPI	Standard Commands for Programmable Instruments
SoC	System on Chip
SDK	Software Development Kit
SPI	Serial Peripheral Interface
SW	Software
TX	Transmit
UART	Universal Asynchronous Receiver/Transmitter
UI	User Interface
USB	Universal Serial Bus

---

**DA1458x/DA1468x Production Line Tool**

---

VISA	Virtual Instrument Software Architecture
VPP	Programming supply voltage (pin)
XML	Extensible Markup Language
XTAL	Crystal
XSD	XML Schema Definition

---

**DA1458x/DA1468x Production Line Tool**

---

**2 References**

- [1] UM-B-040, DA1458x/DA1468x Production Line Tool, User manual, Dialog Semiconductor.
- [2] UM-B-014, DA1458x Bluetooth Smart Development Kit - Expert, User Manual, Dialog Semiconductor
- [3] [FT4232H – Hi-Speed Quad USB UART IC](#), FTDI Chip.
- [4] [FT232 – USB UART IC](#), FTDI Chip
- [5] Anritsu MT8852B, <https://www.anritsu.com/en-US/test-measurement/products/mt8852b>
- [6] Keysight 34401A, <http://www.keysight.com/en/pd-1000001295%3Aeps%3Apro-pn-34401A/digital-multimeter-6-digit?cc=US&lc=eng>
- [7] Keithley 2000, <http://www.tek.com/tektronix-and-keithley-digital-multimeter/keithley-2000-series-6%C2%BD-digit-multimeter-scanning>
- [8] Papouch TMU USB thermometer, <https://www.papouch.com/en/shop/product/tmu-usb-thermometer/>
- [9] NI USB TC-01, <http://sine.ni.com/nips/cds/view/p/lang/en/nid/208177>
- [10] Honeywell Xenon 1900, <https://www.honeywellaidc.com/products/barcode-scanners/general-duty/xenon-1900g-1902g>
- [11] Zebra/Motorola LS2208, <https://www.zebra.com/us/en/products/scanners/general-purpose-scanners/handheld/ls2208.html>
- [12] AN-B-020, DA14580 End product testing and programming guidelines, Application Note, Dialog Semiconductor
- [13] Litepoint IQxel-M, <http://www.litepoint.com/test-solutions-for-manufacturing/ixxel-m/>
- [14] NI USB-6009 DAQ, <http://sine.ni.com/nips/cds/view/p/lang/en/nid/201987>
- [15] Keysight 34461A, <http://www.keysight.com/en/pd-2270273-pn-34461A/digital-multimeter-6-digit-34401a-replacement-truevolt-dmm?cc=GR&lc=eng>

---



---

**DA1458x/DA1468x Production Line Tool**

### 3 New version features

This manual explains the usage of the 16 channel DA1458x/DA1468x Production Line Tool (PLT). It refers to the DA1458x\_DA1468x\_PLT\_v4.2 software release, which compared to DA1458x\_DA1468x\_PLT\_v4.1 has the added features illustrated in [Table 1](#).

**Table 1: DA1458x\_DA1468x\_PLT\_v4.2 added features**

#	Features	Description
1	DA14682/3, DA15100/1 are now supported.	Supports the new DA14682/3 and DA15100/1 chipset with all the memory and production tests that the DA1681 (AE) supports (for the DA15100/1 devices only the BLE path is supported).
2	DA14585/586 audio testing.	DA1485/6 devices now support audio testing.
3	Production test firmware faster download time for the DA14681/2/3 and DA15100/1 devices.	DA14681/2/3 and DA15100/1 production test firmware can now be downloaded through the <code>uartboot.bin</code> firmware in 1Mbaud and reduce the total download time.
4	Improved current measurements.	In case of failure, the PLT switches off the devices one by one until the failed DUT is found.

## 4 Introduction

By using the PLT it is possible to test, calibrate and load firmware for 16 different devices under test (DUTs) in parallel.

The following are deliverable parts of the tool.

- Hardware
  - Main board (Figure 1) together with a DA14580-QFN48 Golden Unit.
  - Electrical schematics of the main board.
  - Gerber files of the main board.
  - Bill of Materials of the main board.
- Software
  - Source code files organized in a Microsoft® Visual Studio Express 2015 solution.
  - Application executables and required DLLs.
- Documents.

An example of a sequence of actions the tool performs is given below. All of the actions are performed in parallel for up to 16 devices.

1. Download the production test firmware (e.g. prod\_test\_580.bin).
2. Perform automatic crystal (XTAL) trimming.
3. Perform RF RSSI test.
4. Download and burn the customer firmware (into OTP, SPI flash, QSPI flash or I2C EEPROM)
5. Burn the OTP header.
6. Perform Scan test. Reset the DUTs and set the GU to scan for the DUT BLE advertisements.

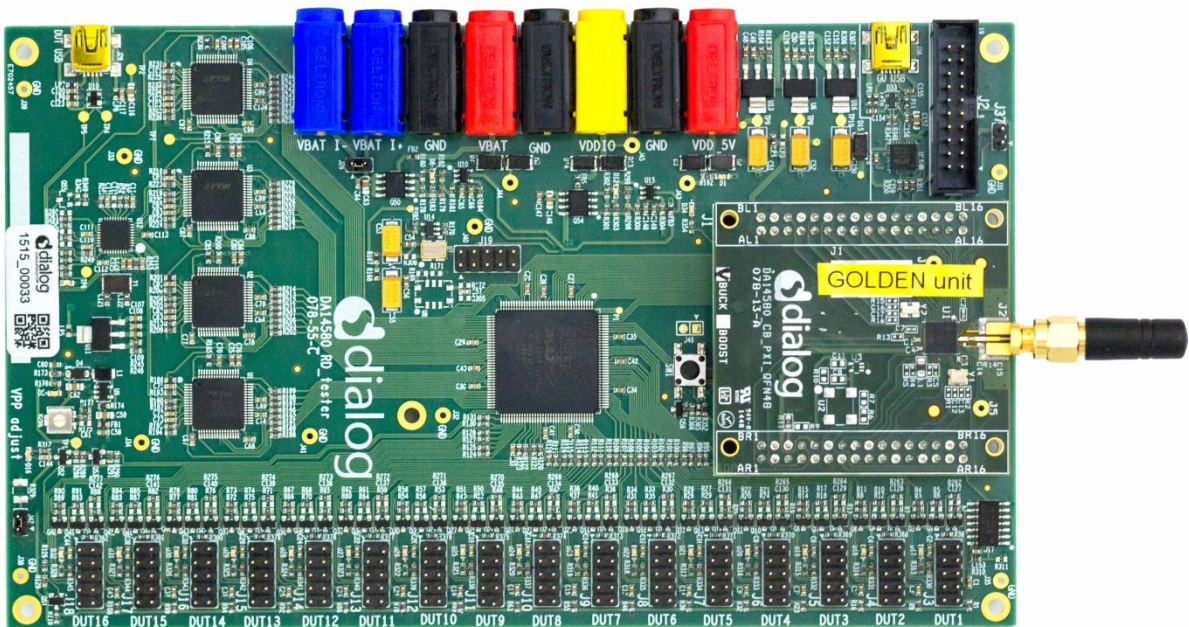

Figure 1: Production Line Tool Hardware

## 5 Hardware

### 5.1 Hardware Block Diagram

The Production Line Tool hardware consists of various blocks, as illustrated in

Figure 2. These blocks are explained below.

- **Blue blocks:** USB-to-UART interfaces.
  - Four **FT4232 FTDI QUAD** USB-to-UART interfaces are used for a 16 channel USB-to-UART conversion.
  - The GU is connected to the PC via an **FT232 FTDI** USB-to-UART interface.
- **Red block:** A **CPLD** that has the following purpose.
  - Switch UART signals between the PC USB-UART and DUTs.
  - Switch DUTs VBAT signal
  - Switch DUTs VPP signal (only when VBAT is enabled).
  - Produce Reset signal to the DUTs.
  - Produce 500 ms XTAL calibration pulse.
- **Orange block:** A **Golden Unit** (GU) is mounted, which has the following functionality:
  - CPLD control using custom commands.
  - Transceiver for Bluetooth RF signals to and from the DUTs.
  - Produce an audio tone using PWM, used for audio testing.
  - Scan for device BLE advertisements, after the customer firmware has been programmed.
- **Purple blocks:** Sixteen (16) device connectors.

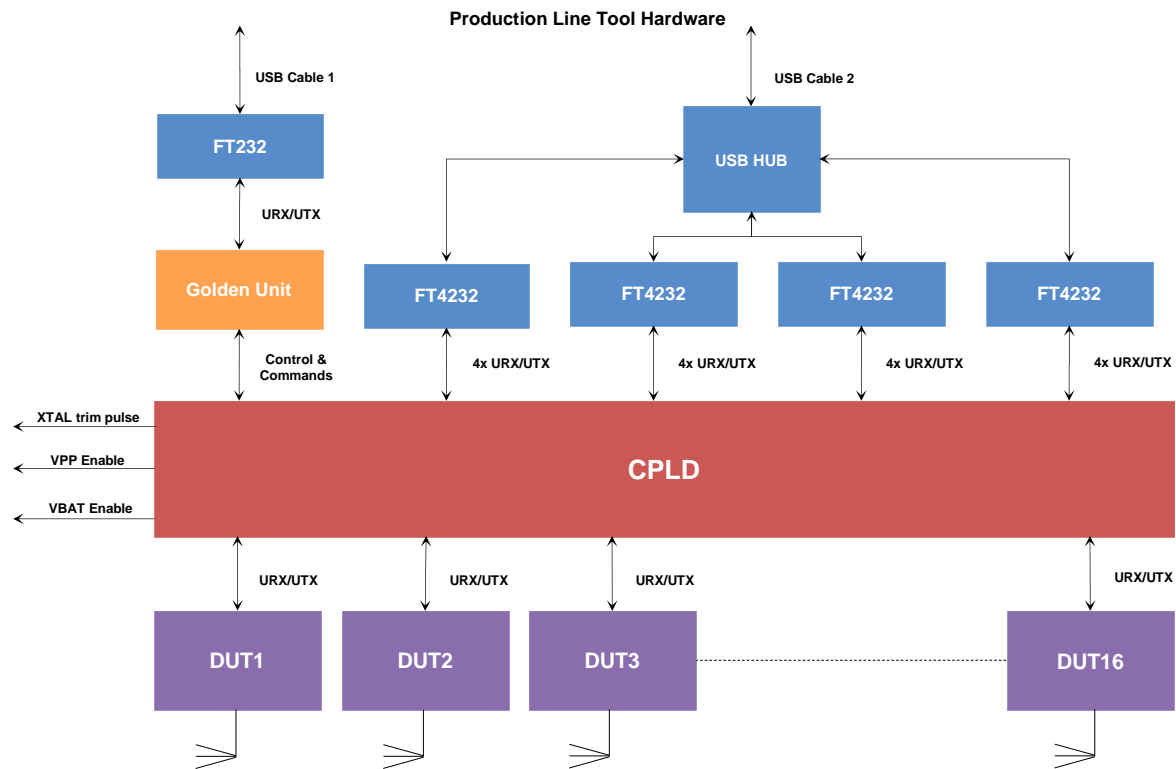

Figure 2: Production Line Tool Hardware Board Block Diagram



### 5.2 Printed Circuit Board Layout

In [Figure 3](#) the top view of the PLT board is illustrated. The important parts are pointed by the orange boxes. The *VPP jumper* and the *Current jumper* are colored in blue.

The Golden Unit has a DA14580 QFN48-die soldered. Most of the 48 pins are basically used to connect to the CPLD. The CPLD is programmed during the production of the PLT board via the CPLD socket. No need for the users to use the CPLD socket.

The black banana sockets are all connected to the same ground (GND) plane.

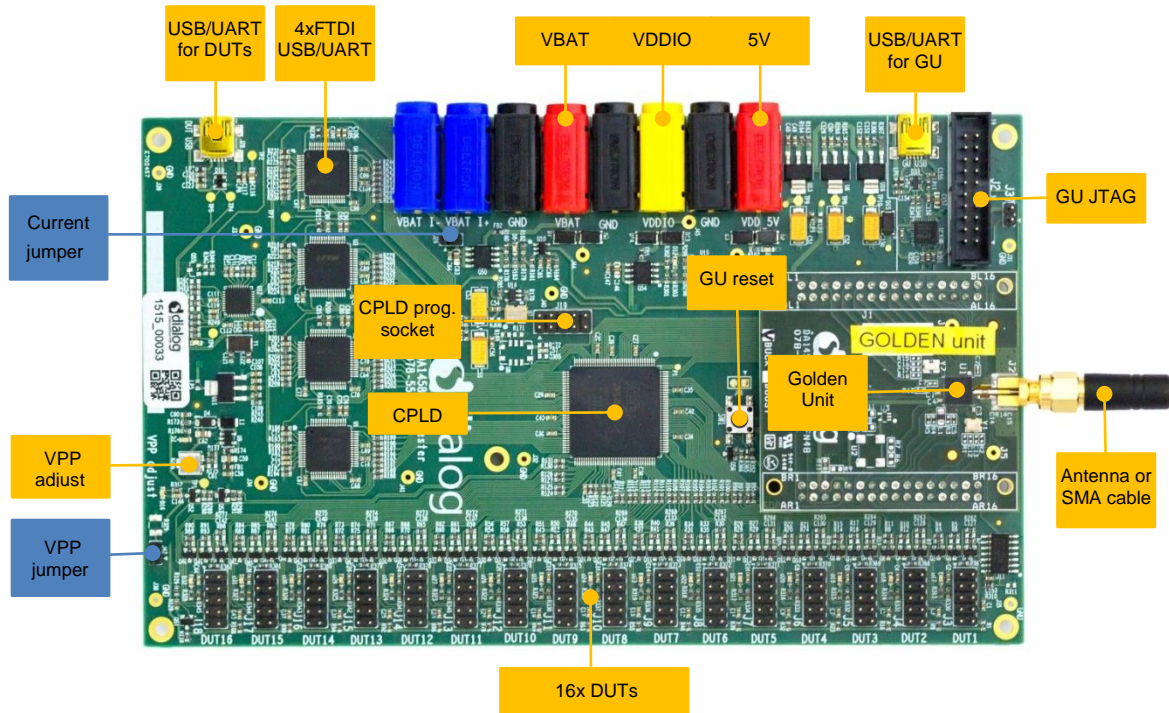

Figure 3: Top View of the PLT Hardware Board (Version C)

### 5.3 PLT Power Supply

External power supply is needed for the PLT to run. This should be connected to the banana sockets as shown in [Figure 4](#).

[Table 2](#) shows the voltage and current requirements for each power supply. The blue banana sockets can be used for device current measurements.



Figure 4: PLT Hardware Power Connections

DA1458x/DA1468x Production Line Tool

Table 2: Power Supply Requirements

Power Supply	Voltage (V)	Current (mA)	
		Buck Mode	Boost Mode
VBAT	2.4 ... 3.3	16 x 20	n.a.
VDDIO	2.4 ... 3.3	70	n.a.
VDD 5V	4.75 ... 5.25	~335	~335
VPP	6.6 ... 6.8	16 x 2	16 x 2

5.4 DUT Connector

The BLE devices are connected to the PLT using the DUT1-16 connectors at the edge of the PLT board. Figure 5 shows the pin-header connections from the Production Line Tool hardware board to the DUTs. Table 3 describes the purpose of each pin.

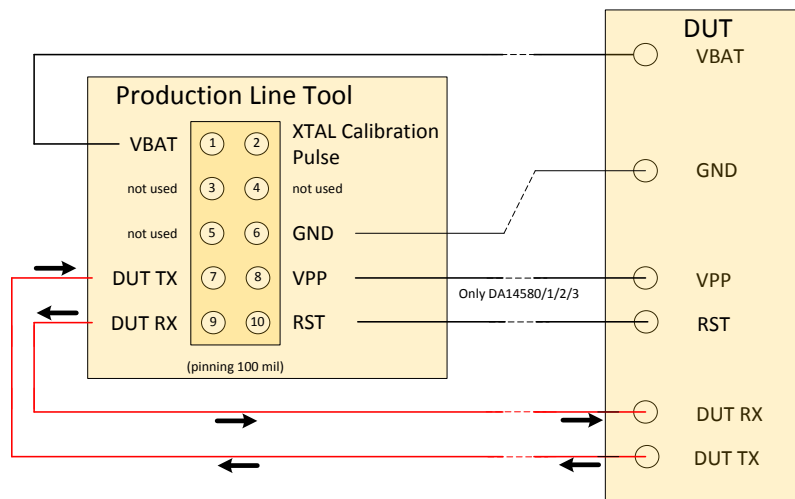

Figure 5: Production Line Tool DUT Connections

Table 3: PLT Connections to Applications

Header Pin	Name	Description
1	VBAT	Depending on the <a href="#">VBAT/Reset Signals Operation</a> mode this can be used as Voltage supply for the DUT or as Reset signal. Due to this connection, no external power supply is needed for the DUTs. This pin must be connected if there is no other power supply (e.g. battery).
2	XTAL Calibration Pulse	This pin can be used as a reference pulse during the automatic crystal calibration. More details are given in <a href="#">7.2.6.1</a> for DA1458x devices and in <a href="#">7.2.10.1</a> for DA1468x devices. The crystal trim pulse can also be supplied in the UART RX device pin. This is the most common scenario. However, there may be hardware limitations where the UART RX pin cannot be used. In such cases the particular PLT header pin is used.
6	GND	Ground pin. This pin must be connected.
7	DUT TX	This is connected to the device UART TX pin. This pin must be connected.
8	VPP	This pin provides the 6.8V required to program the OTP in the DA14580/1/2/3 devices. <b>Note:</b> This option is <b>not</b> available with the <a href="#">VBAT as Reset</a> mode.

Header Pin	Name	Description
9	DUT RX	This is connected to the device UART RX pin. This pin can also provide the crystal calibration reference pulse for the automatic crystal (XTAL) trim procedure, as described in 7.2.6.1 for DA1458x devices and in 7.2.10.1 for DA1468x devices. This pin must be connected.
10	RST	The reset signal must be connected if battery powered devices are used.

### 5.5 Data Streaming

Figure 6, Figure 7 and Figure 8 illustrate the three possible data streams through the CPLD. The CPLD switches S1, S2, S3 and S4 are controlled by the software via the Golden Unit.

#### Normal Operation (Figure 6):

**UART-RxD data is transported via the RED arrows (AA):**

PC → USB → USB HUB → Quad UART → CPLD signal 'AA' → DUT RxD (programmed as RxD).

**UART-TxD data is transported via the BLUE arrows (BB):**

PC ← USB ← USB HUB ← Quad UART ← CPLD signal 'BB' ← DUT TxD.

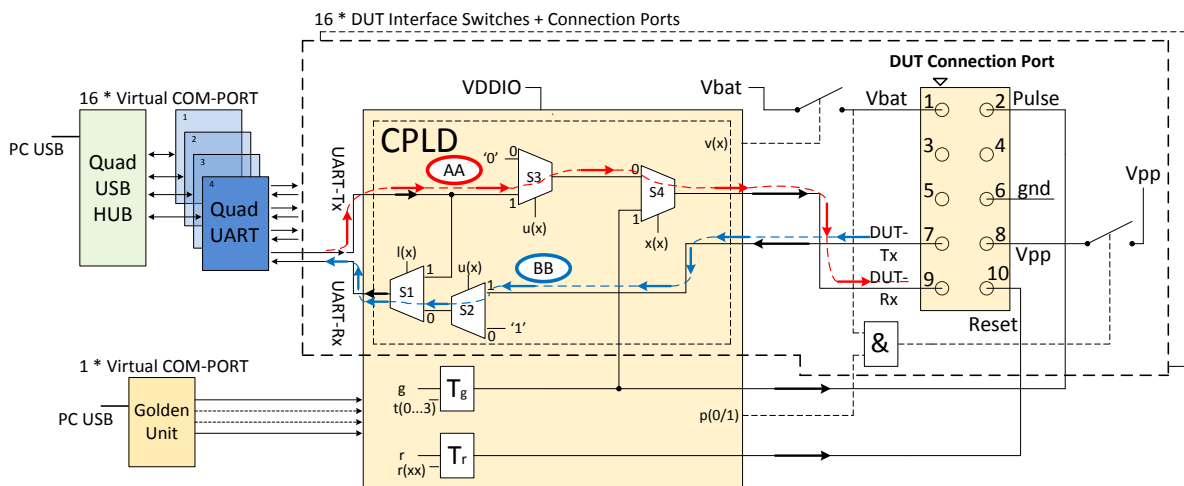

Figure 6: CPLD UART Data Streams

#### Crystal Trimming (Figure 7):

**The XTAL calibration pulse (500 ms) is transported via the PURPLE arrows (CC):**

CPLD TIMER T<sub>g</sub> → CPLD S4 → DUT RxD (programmed as GPIO).

**UART-TxD data is transported via the BLUE arrows (BB):**

PC ← USB ← USB HUB ← Quad UART ← CPLD signal 'BB' ← DUT TxD.

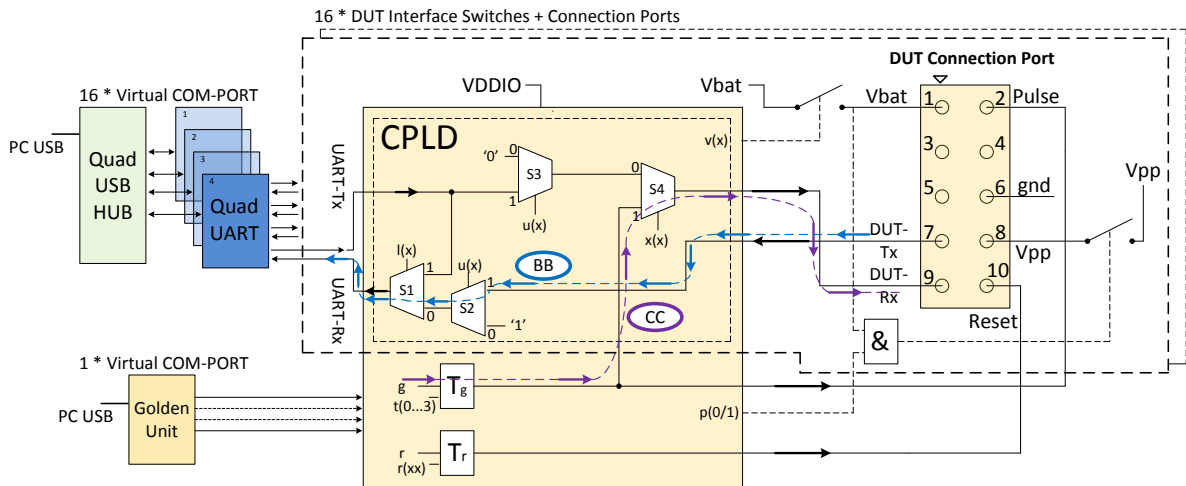

Figure 7: CPLD XTAL Trim Pulse Data Stream

**Loopback Operation (Figure 8):**

Loopback operation is used during the start of the tests. The PC PLT software uses this feature to automatically find the numbers of the Virtual COM ports in the Windows PC.

**The UART loopback data is transported via the GREEN arrows (DD):**

PC → USB → USB HUB → Quad UART → CPLD signal 'DD' SW1 → Quad UART → USB HUB → USB → PC.

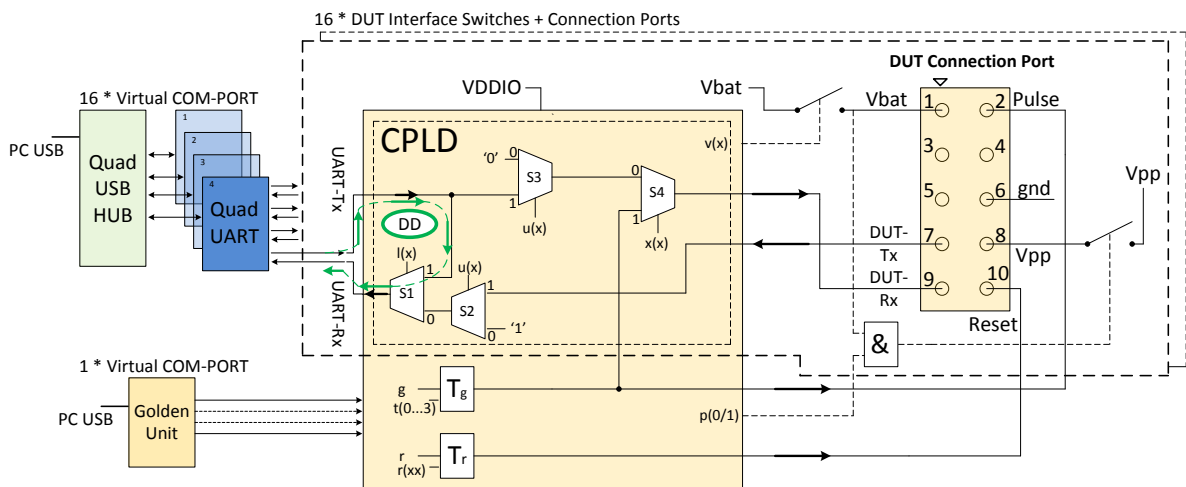

Figure 8: CPLD UART Loopback Data Stream

**Note:** The CPLD is also used to switch the UART signals between the QUAD FTDIs and the DUTs. When the VBAT is switched off and the UART wires are not disconnected, a 'rest voltage' may be present on the product. This could cause problems with the Power On Reset (POR) and the product might not boot correctly. The CPLD will switch off the UART signals when the VBAT is not present.

## 5.6 Golden Unit



Figure 9: Golden Unit

The Golden Unit (GU) is a 'daughter' board mainly used in the Expert Development Kit [2]. In the PLT, the GU is used for various purposes:

- RF transmitter for the RF RSSI DUT test.
- RF Receiver for the device BLE advertisement scan test.
- Audio tone generator for the audio test.
- Controlling the CPLD.

The GU uses an SPI Flash memory mounted on the PLT board. The SPI Flash is pre-programmed with a specific production test firmware. If required, there are several ways to upgrade the GU firmware, either via the PLT's GU JTAG connector or via the UART. The latest GU firmware can be found inside the latest PLT software release, under the `executables\binaries\GU` folder.

**Note:** PLT v4.1 and onwards requires the latest firmware version of the Golden Unit. If the Golden Unit firmware is not updated then the PLT applications will not run.

**Note:** The Golden Unit is calibrated during PLT production. It is delivered with a calibration characterization document.

### 5.6.1 GU Reset

The Golden Unit includes a hardware reset circuit. The GU reset signal is connected to an FTDI FT232 GPIO pin.

Figure 10 illustrates the electrical schematics of the GU reset circuit. Section 5.8.3 illustrates the jumper positions on the PLT PCB.

The red line is the connection between the FTDI IC GPIO pin (DTR) and the GU reset signal on the PLT GU connector header. The PLT software controls this pin via the FTDI DLL driver `ftd2xx.dll`. Making pin DTR low for a short period of time will reset the GU. Every time the PLT tests start, a hardware reset is issued to the Golden Unit. Jumper J47 should be ON and J46 OFF for this reset method to operate.



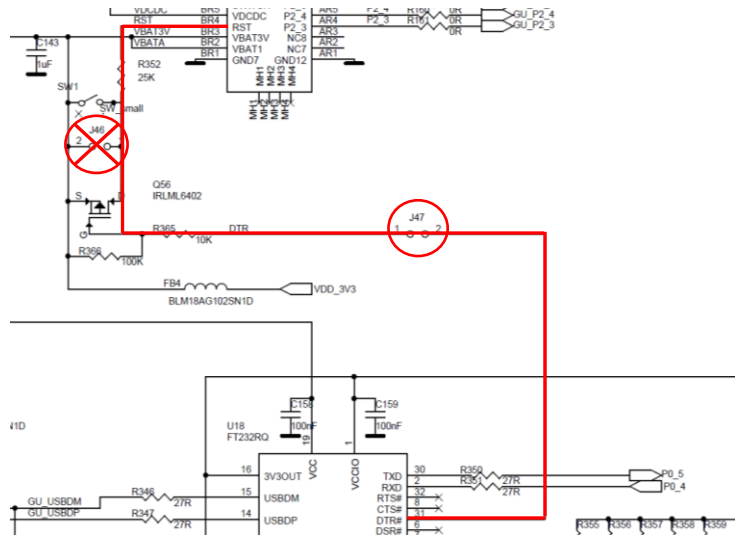

Figure 10: GU Reset Circuit

### 5.7 Current Measurements

The PLT board provides connections to perform DUT current measurements (see Figure 11). By connecting a current meter to the blue banana sockets the combined VBAT current of all DUTs can be measured. Jumper J26 should be removed when a current meter is connected. If no current meter is used, jumper J26 should be mounted. See also section 5.8.

The connection shown in Figure 11 can only be used with the VBAT Only and VBAT On with Reset (when the VBAT lines are used to power the DUTs) modes. If the DUTs are powered using a single external power supply then the multi-meter should be connected on that power supply in a similar way as described before with the PLT. If the DUTs are powered independently (e.g. each one with its own battery) the current measurement procedure cannot be used.

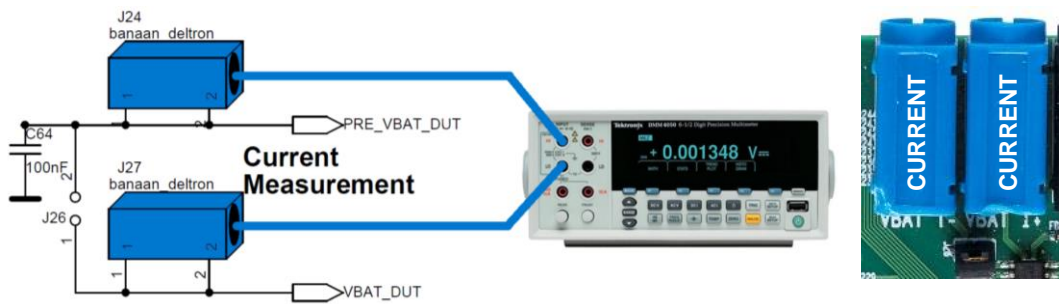

Figure 11: VBAT DUT Current Measurement Setup

### 5.8 Jumper Settings

This section describes the PLT hardware jumper settings.

Table 4: Jumpers

Jumper	PLT HW version	Description
J26	A, B, C, D	Connects the VBAT line from the PLT power supply to the DUTs. This jumper can be used when there is no multi-meter instrument connected for current measurement.

Jumper	PLT HW version	Description
J37	B, C, D	This jumper sets the Golden Unit's SPI Flash chip select (CS) pin to high. This jumper is needed placed when the Golden Unit should <b>NOT</b> boot from the SPI flash.
J42	B, C, D	Feeds the VPP lines of the DUT connectors with VPP voltage used for OTP burning in DA14580/1/2/3 DUTs.
J46	C, D	This jumper can be used to reset the Golden Unit. The two pins on the jumper are the same as the ones in the GU reset switch next to the jumper.
J47	D	This jumper connects the Golden Unit's FTDI DTR line to the Golden Unit's reset pin. With this jumper on the PLT software can reset the Golden Unit on-demand.

#### 5.8.1 J26 - Current Measurements

As shown in [Figure 12](#), jumper J26 should be mounted when no external current meter is attached. Otherwise, when a current meter is connected via the blue banana sockets to measure the device current, the J26 jumper should be removed.

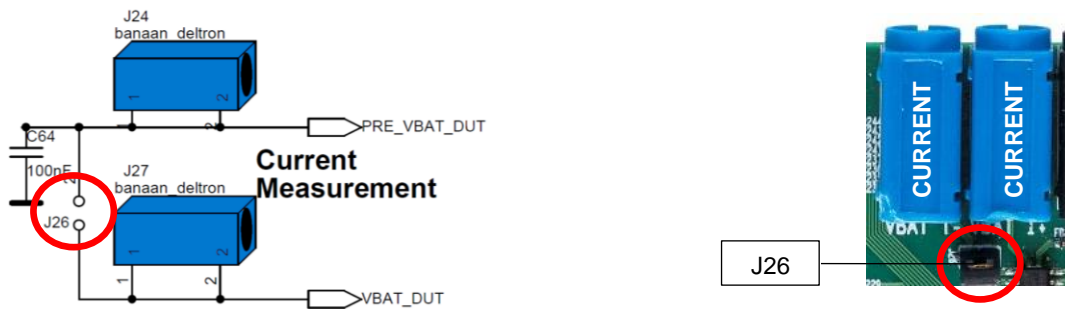

Figure 12: Connections for 'Floating Current' Measurements

#### 5.8.2 J42 - DA1458x OTP Burning Voltage

If DA14580/1/2/3 OTP programming is required, the VPP line should be connected between the PLT DUT connector and the actual DUT ([Figure 5](#)). Jumper J42 on the PLT board should also be mounted. [Figure 14](#) shows the jumper position on the PLT hardware board.

[Figure 13](#) illustrates the electrical schematics of the VPP and the location of the J42 jumper.

DA14585/6 and DA1468x devices do not need an external voltage for the OTP to be burned. Therefore, the VPP line from the PLT DUT connector ([Figure 5](#)) should not be connected to the DA1468x DUT.

**Note:** The VPP line feature **cannot** be used with the **VBAT as Reset** mode.

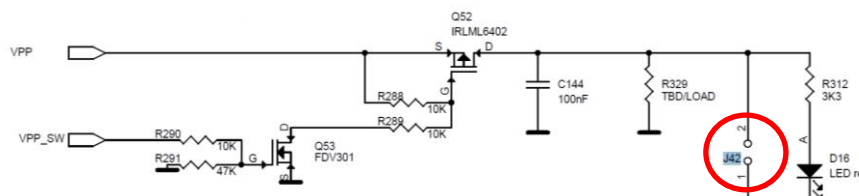

Figure 13: VPP Control Circuit Schematic



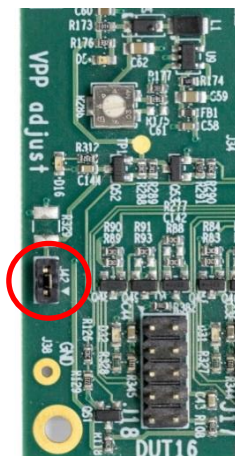

Figure 14: Location of the VPP Jumper J42

### 5.8.3 J47, J46 - GU Reset

For a GU hardware reset, jumper J47 should be mounted and jumper J46 should be removed. These two jumpers are involved in the circuit illustrated in

Figure 10. In this way, the GU hardware reset will be controlled by the PLT software. Figure 15 shows the jumper placement on the actual PCB.



Figure 15: Location of J46 Jumper

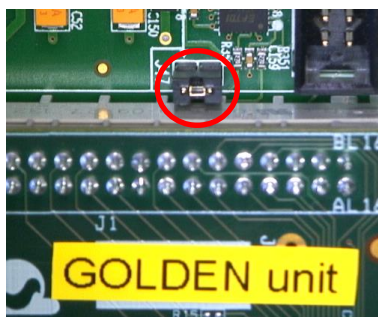

Figure 16: Location of J47 Jumper

### 5.8.4 J37 - GU Programming

Jumper J37 connects the Chip Select of the GU SPI Flash to a logic high level. This causes the GU not to boot from the already programmed SPI Flash, allowing the GU to load different code into its SysRAM via the JTAG connector or via UART. Figure 17 shows the circuit schematic and Figure 18 shows the location of jumper J37 on the PLT PCB.

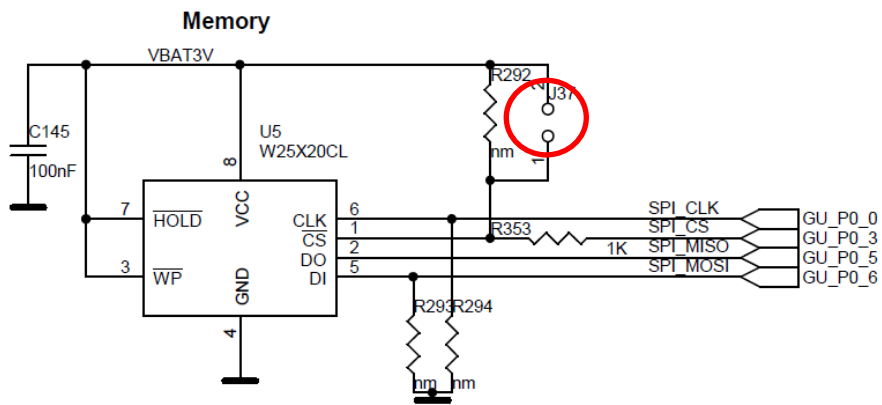

Figure 17: J37 - GU Programming Jumper Schematics



Figure 18: Location of J37 Jumper

5.9 PLT Functional Blocks

Figure 19 shows an overview of the PLT hardware functions. For detailed electrical schematics see Appendix B.

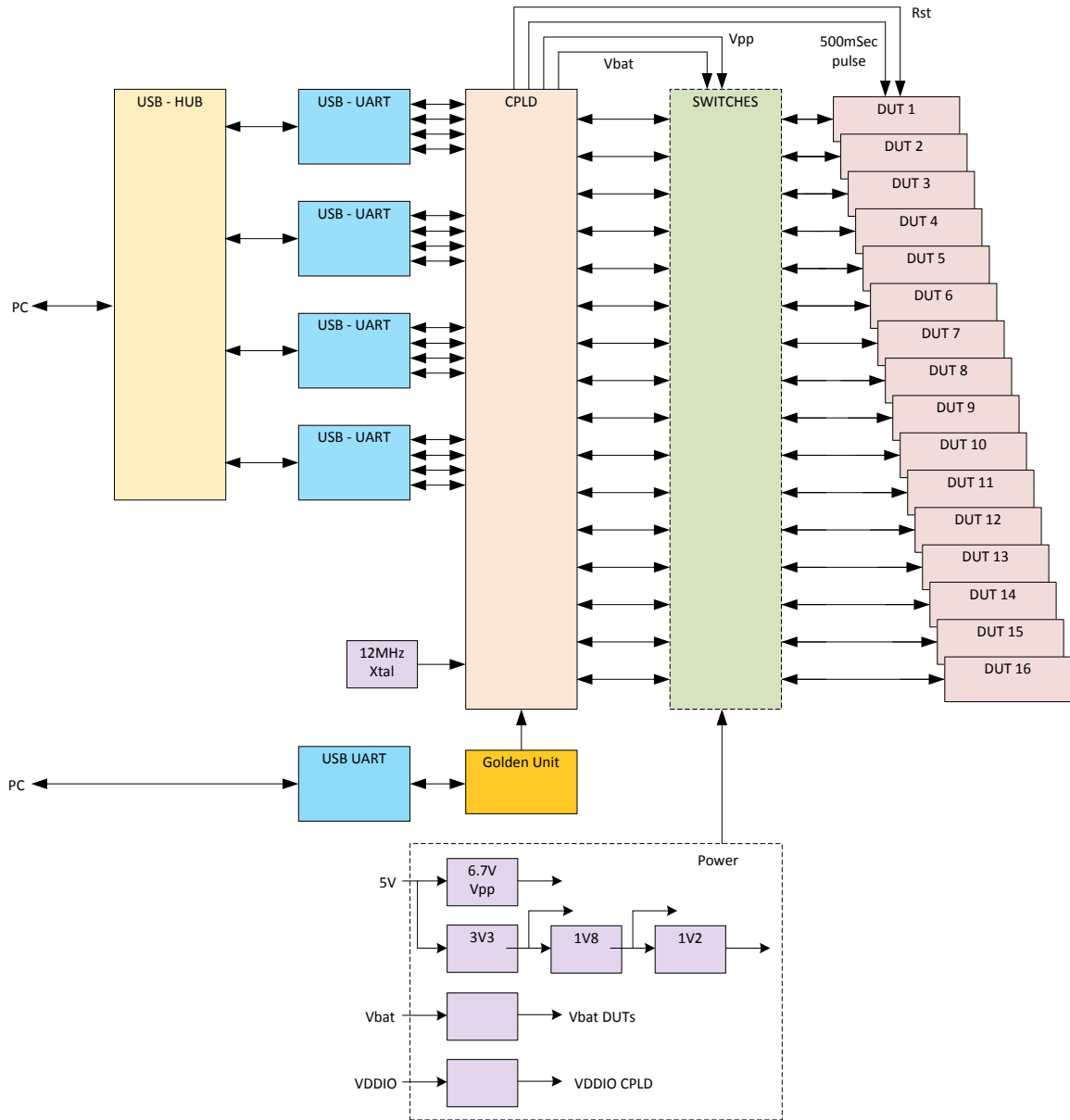

Figure 19: PLT Functional Blocks

## 6 Software

### 6.1 Introduction

The Production Line Tool software is a collection of software blocks that interact with each other, as shown in Figure 20. Its main purpose is to communicate with the PLT hardware and the DUTs in order to run the production tests and perform memory operations. The software blocks can be arranged in three main groups:

- **Red blocks:** User Interface (UI) applications.
- **Blue blocks:** Core libraries.
- **Green blocks:** Instrument interface libraries.

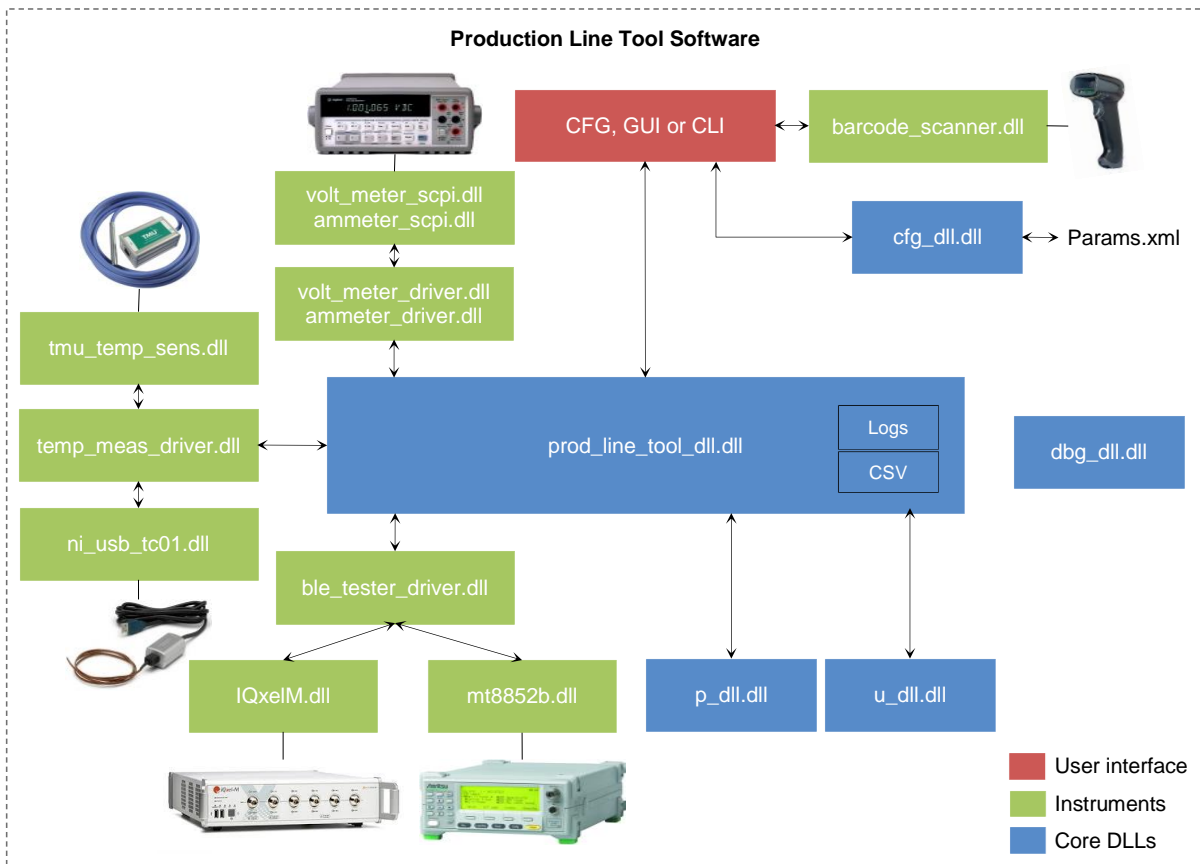

Figure 20: Production Line Tool Software Block Diagram

Core libraries and instrument interface libraries are explained in detail in UM-B-040 [1]. The User Interface applications block consists of three application executables. For details see section 0.

Table 5: PLT User Interface Application Executables

Short Name	File Name	Description
CFG_PLT	DA1458x_DA1468x_CFG_PLT.exe	Configuration application. Load, edit and save the test parameters and the memory actions to be performed during device testing.
GUI_PLT	DA1458x_DA1468x_GUI_PLT.exe	Graphical User Interface (GUI) application. Performs the actual device validation and memory programming. Provides a visual indication of the test results and access to the result logs.

## DA1458x/DA1468x Production Line Tool

Short Name	File Name	Description
CLI_PLT	DA1458x_DA1468x_CLI_PLT.exe	The same as the GUI PLT but console based.

### 6.2 DA15100/1 support

DA15100/1 devices are supported from the PLT v4.2. Since the DA15100/1 a BB version chipset similar to the DA14683 the same tests are supported, shown in [Table 14](#). Thus in this user manual the DA15100/1 chips are treated as DA14682/3, meaning that a generic reference of the DA1468x chip includes the DA15100/1 chips.

### 6.3 Software Package Contents

The PLT software release package comes in a compressed folder `DA1458x_DA1468x_PLT_v_X.zip`, where 'X' represents the version number of the current PLT release.

[Figure 21](#) illustrates the main folders of the PLT software package. Folder `executables` holds all the executables and libraries needed for the PLT to run on a Windows 7/8/8.1/10 machine. Folder `source` contains the entire source code of the PLT, organized in a Visual Studio Express 2015 solution.

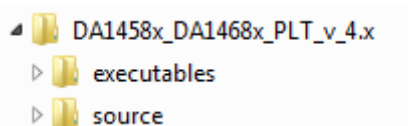

**Figure 21: DA1458x/DA1468x PLT Software Package Contents**

[Table 6](#) gives a short description of the files and folders contained in the `executables` directories.

**Table 6: Executables Folder Description**

File or Folder	Description
<code>ammeter_instr_plugins/</code>	Contains the current measurement instrument DLLs, used during the current measurement tests.
<code>ammeter_instr_plugins/ni6009.dll</code>	This is the DLL for the NI-6009 DAQ <a href="#">[14]</a> that could be used in the current measurements. The usage of this instrument for measuring the current requires an external shunt resistor and things complicate when the measurement switches from many DUTs to one DUT. We only recommend using this instrument if one DUT per run is tested.
<code>ammeter_instr_plugins/ammeter_scpi.dll</code>	This is the DLL for taking current measurements using a DMM that supports the standard SCPI commands. NI-VISA is also used for this purpose. Example DMM instruments are the Keysight 34401A <a href="#">[6]</a> , the Keithley 2000 <a href="#">[7]</a> or the Keysight 34461A <a href="#">[15]</a> . The PLT has been tested with all three instruments.
<code>binaries/</code>	Contains the necessary firmware binaries. These are described in detail in <a href="#">UM-B-040 [1]</a> . Additionally, the <code>SetupCode_Generator_680.exe</code> application used in homekit products to create a specific hash key is included.
<code>binaries/GU/prod_test_GU.bin</code>	Contains the Golden Unit latest firmware binary. Users should better upgrade their PLT hardware with the GU firmware contained in this folder.
<code>ble_tester_instr_plugins/</code>	Contains the BLE tester instrument DLLs.
<code>ble_tester_instr_plugins/mt8852b.dll</code>	This is the DLL that performs the Direct Test Mode RF tests using the Anritsu MT8852B instrument <a href="#">[5]</a> .

---



---

**DA1458x/DA1468x Production Line Tool**

File or Folder	Description
ble_tester_instr_plugins/IQxelM.dll	This is the DLL that performs the Direct Test Mode RF tests using the Litepoint IQxelM instrument [13].
icons/	Contains pictures used by the PLT applications.
IQmeasure_3.1.2/	Contains specific Litepoint IQxelM DLLs as released by Litepoint.
params/	Contains the configuration <code>params.xml</code> file, the XML schema <code>params.xsd</code> and a sample of BD address file named <code>bd_address.ini</code> .
params/custom_mem_data.csv	A sample CSV file to be used in the custom memory burn action. Users could edit this file and add their own specific memory data to be burned by the PLT. The PLT will match the entries in the CSV file using the BD addresses. The format of the file is explained later.
scripts/	Contains sample batch script files. User can select batch script files to be executed by the PLT before and after each test.
scripts/run_before_tests.cmd	An example script that copies and renames binaries from a directory to a folder required by the PLT when 'Different image per DUT' is selected. This folder is accessed by the PLT to read and burn different binary per DUT.
scripts/run_after_tests.cmd	An example script that moves all logs files, except the ones with the current date, to a specific folder.
temp_meas_instr_plugins/	Contains the temperature measurement instrument DLLs.
temp_meas_instr_plugins/ni_usb_tc01.dll	The <code>ni_usb_tc01.dll</code> is the DLL used to interface a NI USB TC01 [9] temperature sensor for temperature measurements.
temp_meas_instr_plugins/tmu_temp_sens.dll	The <code>tmu_temp_sens.dll</code> is the DLL used to interface a Papouch TMU sensor [7] for temperature measurements.
volt_meter_instr_plugins/	Contains the voltage meter instrument DLLs. These are used only in DA14681-00 silicon for ADC calibration purposes.
volt_meter_instr_plugins/volt_meter_sspi.dll	The <code>volt_meter_sspi.dll</code> is a DLL that implements basic interface with a DVM using SCPI commands through NI-VISA libraries and GPIB interface. Has been tested with Keithley 2000 [7] and Keysight 34401A [6].
DA1458x_DA1468x_CFG_PLT.exe	This is the configuration application. It is a graphical user interface application used to edit the PLT test configuration parameters, saved in an XML file, <code>params.xml</code> .
DA1458x_DA1468x_CLI_PLT.exe	This is the command line interface tool. It performs the production tests and memory programming through a console.
DA1458x_DA1468x_GUI_PLT.exe	This is the graphical user interface tool. It performs the production tests and memory programming through a graphical user interface.
ammeter_driver.dll/.lib	This is the DLL that loads and accesses all DMM instrument DLLs from inside the <code>ammeter_instr_plugins</code> . It acts as an intermediate layer between the <code>prod_line_tool_dll</code> and the instrument DLLs.
barcode_scanner.dll/.lib	This is the DLL that receives BD addresses from a barcode scanner with USB to serial interface. Has been tested with Honeywell Xenon 1900 and the Motorola LS2208 barcode scan readers [10] [11].
ble_tester_driver.dll/.lib	This is the DLL that loads and accesses all BLE tester instrument DLLs from inside <code>ble_tester_instr_plugins</code> folder.

## DA1458x/DA1468x Production Line Tool

File or Folder	Description
cfg_dll.dll/.lib	This is the configuration parameter handling DLL. It can validate, load and save parameters from a given XML file.
dbg_dll.dll/.lib	The dbg_dll.dll file is a DLL used to print debug messages to a file or to a debug console.
ftd2xx.dll	This is the FTDI DLL. Used to hard reset the Golden Unit from the application whenever needed through an FTDI GPIO pin.
p_dll.dll/.lib	This is the production test DLL that performs device functional tests.
prod_line_tool_dll.dll/.lib	This is the core DLL. The heart of the system that performs the state machines for all tests and memory actions to be executed. It is responsible to log the results and notify the user interfaces about the current device test status.
temp_meas_driver.dll/.lib	This is the temperature measurement driver DLL. It loads and accesses all temperature measurement DLLs from inside the temp_meas_instr_plugins folder.
u_dll.dll/.lib	This is the DLL that performs the memory actions, like the memory programming, erasing, etc.
vc_redist.x86.exe/vc_redist.x64.exe	These are the Visual Studio 2015 Express redistributable packages for 32 and 64bit machines. For installing these, users should agree to the license requirements described during the installation of any of these packages and also found here: <a href="https://www.visualstudio.com/license-terms/mt171551/">https://www.visualstudio.com/license-terms/mt171551/</a> .
volt_meter_driver.dll/.lib	This is the voltage meter driver DLL. It loads and accesses all voltage meter DLLs from inside the volt_meter_instr_plugins folder.

### 6.4 Prerequisites

Before building and running the code, the packages indicated in [Table 7](#) should be installed on the PC. Some are required and others are optional depending on the tests or actions needed.

**Table 7: Production Line Tool Prerequisites**

Item	Optional	Description
Visual Studio 2015 Express	Yes	The IDE used to edit and debug the Production Line Tool. This is only required if users would like to edit the software.
vc_redist.x86.exe/vc_redist.x64.exe	No	Already described in <a href="#">Table 6</a> . Users should agree to the license requirements described during the installation of any of these packages and also found here: <a href="https://www.visualstudio.com/license-terms/mt171551/">https://www.visualstudio.com/license-terms/mt171551/</a> .
MSXML6	No	Installed by default in Win 7/8/8.1/10.
.NET framework 4	No	Needed for the graphical user interface applications.
Latest FTDI drivers	No	Tested with FTDI v2.12.24, v2.12.26 and v2.12.28 drivers.
Honeywell Xenon 1900 drivers	Yes	Needed if the barcode scanner is going to be used for scanning the devices BD addresses and/or custom memory data. Other types of barcode scanners could also be used.
Motorola LS2208 drivers	Yes	Used if a barcode scanner is going to be used for scanning the device BD addresses and/or custom memory data.
NI-VISA 15.5	Yes	Used for optional instrument control, like BLE tester and voltage meter.



**DA1458x/DA1468x Production Line Tool**

Item	Optional	Description
NI-488.2 15.5	Yes	Used for optional instrument control, like BLE tester and voltage meter.
NI_DAQmx	Yes	Used for optional instrument control like temperature measurements using the NI USB TC01 sensor.

## 6.5 System Requirements

Table 8 contains the minimum system requirements for the PLT to operate.

**Table 8: Minimum System Requirements**

Item	Minimum Requirements	
Operating system	Windows 7/8/8.1/10	
CPU	Dual Core CPU	
Memory	1 GB RAM or larger. Each device log can reach up to 40 kB.	
Hard drive	For 100000 devices at least <b>4 GB</b> of available hard disk is required.	
Monitor resolution	1280 x 768 or higher	
Monitor DPI	Smaller - 100% = 96 DPI	Supported
	Medium - 125% = 120 DPI	Supported
	Larger - 150% = 144 DPI	Not supported

## 6.6 Limitations

**Parallel control** of multiple PLT hardware boards on the same PC is **not supported**.

However, by correctly setting up the system, two or more PLT hardware boards could be connected and controlled by multiple GUI PLT application instances on the same PC, but the tests should only be executed **sequentially**. The main reasons for this limitation are indicated below:

- The GU FT232 FTDI IC is programmed to have a special serial string, "DialogSemi" (see [Table 98](#)). This is used in the 'GU COM port find' PLT operation. This operation searches all PC connected FTDIs to find the serial string "DialogSemi". When found, it saves it as the GU COM port number to be used by the PLT. The 'GU COM port find' operation will open and lock, for a short period of time, all Windows COM ports, one by one, even the ones used by the other PLT hardware. If the second GUI PLT application instance is performing test operations at the same time and wants to open its DUT COM ports, the operation may fail.
- When the GUI PLT application starts the test operations, it performs a DUT COM port enumeration. During this process the GU sets the CPLD in UART loopback mode. It opens all PC COM ports one by one and sends a specific word, while trying to see if it receives it back. During this process, other PLTs may need to work with 'their' DUT COM ports, which may happen to be currently used by the 'DUT COM port enumeration' process of the first PLT.
- GU hardware reset. In every PLT test run a GU HW reset is issued from the PLT software using a specific GU FTDI GPIO pin. In order to access the GU FTDI the FTDI API is used from `ftd2xx.dll`. To access the FTDI hardware and read the serial number through the FTDI `ftd2xx.dll` the `FT_Open` API is used on all PC COM ports, one by one. Since `FT_Open` is used in all PC COM ports, conflicts could arise if other PLTs would also like to use these COM ports.
- BD addresses handling. Usually, the PLT automatically sets the DUT BD addresses by increasing them one by one. Special care should be taken to work with multiple PLT hardware and software. Most probably, two different BD address files should be used for each different PLT hardware.

DA1458x/DA1468x Production Line Tool

6.7 Building the Code

The PLT software release package contains not only application executables for directly performing the tests out of the box, but also the entire source code of the tools. This is organized in a Visual Studio 2015 Express solution.

To open the Visual Studio 2015 Express PLT source code solution the following steps should be executed (see Table 9).

**Table 9: Opening the PLT Visual Studio 2015 Express Source Code Solution**

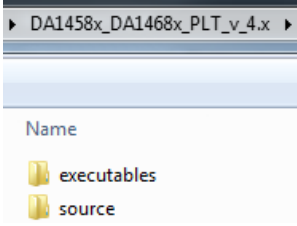
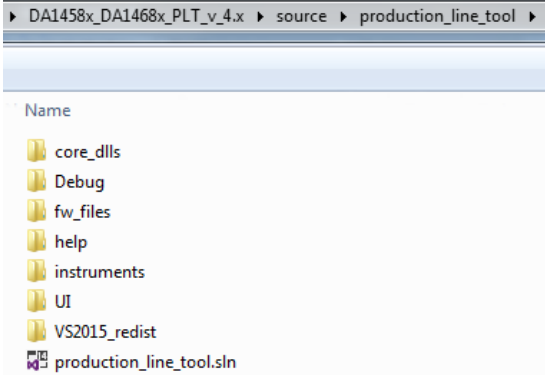
Step	Description
1	Download the latest PLT software package (e.g. DA1458x_DA1468x_PLT_v_4.x.zip)
2	<p>Extract the software package. The following two folders should exist.</p> 
3	<p>Go to folder 'source\production_line_tool'. The following files and folders should exist.</p> 

DA1458x/DA1468x Production Line Tool

Step	Description
4	<p>Double click the <code>production_line_tool.sln</code> Visual Studio 2015 Express solution file. The Visual Studio 2015 Express application will start and the PLT Solution Explorer should be shown.</p>
5	<p>To build the code follow the process described in the <i>UM-B-040</i> document [1].</p> <p><b>Note:</b> Some Visual Studio projects may need to be unloaded prior to building the code, as they require external libraries to be installed. Please read <i>UM-B-040</i> [1] for details.</p>

### 6.8 Executing the Applications

To execute the Production Line Tool applications the process described in the following tables should be followed.

**Table 10: DA1458x\_DA1468x\_CFG\_PLT.exe Application Execution**

Step	Description
1	Download the latest PLT software package (e.g. <code>DA1458x_DA1468x_PLT_v_4.x.zip</code> ).
2	<p>Extract the software package. The following two folders should exist.</p>

DA1458x/DA1468x Production Line Tool

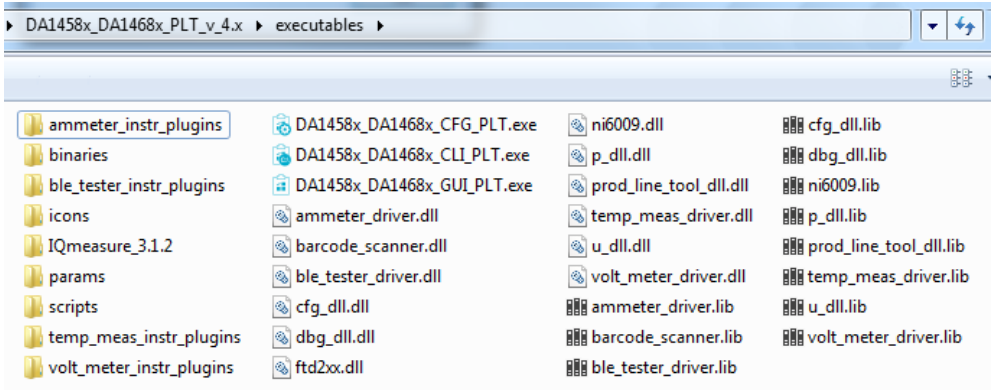
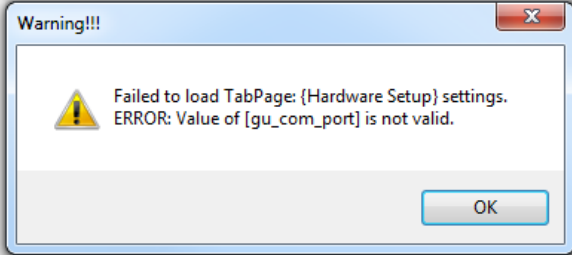
Step	Description
3	<p>Go to folder 'executables'. This folder should contain the following files and sub-folders.</p> 
4	<p>Double click the DA1458x_DA1468x_CFG_PLT.exe application executable. Most probably the following warning will be shown.</p>  <p>During start-up, the DA1458x_DA1468x_CFG_PLT.exe application loads the Hardware configuration parameters from the params.xml file. These parameters also contain the GU COM port. The default params.xml file has the GU COM port set to 4. If this COM port number does not exist in the PC then this warning message will be shown. Therefore, this warning message indicates that the GU COM port set in the params.xml file is not valid or that the GU USB cable is not connected to the PC.</p> <p>Press 'OK' if the warning message appears.</p>

DA1458x/DA1468x Production Line Tool

Step	Description
5	<p>The application will start and the initial <i>Hardware Setup</i> screen will be shown.</p>
6	<p>Connect the PLT HW to the PC. Connect the GU and the DUT USB cables to the PC. Check the Windows Device Manager that 17 new COM ports were found, 16 for the DUTs and 1 for the GU. The following picture is an example of a Device Manager COM ports for a PC that has the PLT connected.</p>

DA1458x/DA1468x Production Line Tool

Step	Description
7	<p>On the DA1458x_DA1468x_CFG_PLT.exe Hardware Setup initial screen press <b>Auto</b> to automatically find the GU COM port among the 17 Windows enumerated COM ports. The <b>Auto</b> button will turn green if successful. Press <b>Save*</b> to save the new GU COM port in the params.xml file.</p> <p>C:\DA1458x_DA1468x_PLT_v4.x\params\params.xml <span style="float: right;">Save*</span></p>

Table 11: DA1458x\_DA1468x\_GUI\_PLT.exe Application Execution

Step	Description
1	To successfully start the DA1458x_DA1468x_GUI_PLT.exe application, the DA1458x_DA1468x_CFG_PLT.exe should be executed first in order to set up the system and perform the required tests. See Table 10.
2	<p>Go to folder 'executables'. This folder should contain the following files and sub-folders.</p>
3	<p>Double click the DA1458x_DA1468x_GUI_PLT.exe application executable. The following initial screen will appear.</p>
4	By clicking the keyboard spacebar, the <b>START</b> button will be pressed and the preconfigured tests and memory actions will start to be executed.

DA1458x/DA1468x Production Line Tool

Table 12: DA1458x\_DA1468x\_CLI\_PLT.exe Application Execution

Step	Description
1	To successfully start the DA1458x_DA1468x_CLI_PLT.exe application, the DA1458x_DA1468x_CFG_PLT.exe should be executed first, in order to set up the system and perform the required tests. See Table 10.
2	<p>Go to folder 'executables'. This folder should contain the following files and sub-folders.</p>
3	<p>Double click the DA1458x_DA1468x_CLI_PLT.exe application executable. The following initial screen will appear.</p>
4	Type 's' and then press Enter. The preconfigured tests and memory actions will start to be executed.

6.9 Test Sequence

This section describes the sequence of steps involved in the DA1458x and DA1468x device testing. It will outline all the steps the PLT follows to successfully test a device.

6.9.1 DA1458x Test Sequence

Table 13 describes each step the PLT undertakes for DA1458x devices. Some of the steps are optional and will only be executed if the equivalent actions are enabled in the configuration parameters. Additionally, some of the steps are supported only for specific DA1458x IC versions.

The entire test sequence for the DA1458x DUTs is shown in Figure 22.

Table 13: DA1458x Test Sequence

Step	Device	Action	Opt	Description
1	DA1458x	Statistics update	No	Update the total tests executed.
2	DA1458x	BD addresses	No	Update the BD addresses for all DUTs.



## DA1458x/DA1468x Production Line Tool

Step	Device	Action	Opt	Description
3	DA1458x	Configuration parameters	No	Configuration parameters are passed from the CLI or GUI to the <code>prod_line_tool_dll</code> . If any of the parameters is not valid an error will occur.
4	DA1458x	Reset GU	No	Golden Unit hardware reset by controlling an FT232 pin.
5	DA1458x	Initialize CPLD	No	Set the CPLD to an initial known state.
6	DA1458x	Check temperature sensor instrument	Yes	Check whether the temperature measurement instrument is online, only if the temperature measurement test is active.
7	DA1458x	Check BLE tester instrument	Yes	Check whether the BLE tester instrument is online, only if any of the BLE tester test operations is active.
8	DA1458x	Check ammeter instrument	Yes	Check whether the ammeter instrument is online, only if any of the current measurement tests is active.
9	DA1458x	Toggle GU LED	No	Toggle the GU red LED on the PLT hardware to indicate that the GU is alive.
10	DA1458x	Check DUT COM ports	No	Check whether the PLT has identified the DUT COM ports and if not run the automatic DUT COM port identification.
11	DA1458x	Temperature measure	Yes	If the temperature measurement test is active, take a measurement and log it to all DUT logs and in the CSV file.
12	DA1458x	Download <code>prod_test_58x.bin</code>	Yes	If any of the production tests is active (e.g. RF tests, XTAL trim, etc.) download the <code>prod_test_58x.bin</code> to the devices.
13	DA1458x	Open the devices COM ports and get the <code>prod_test_58x.bin</code> firmware version.	Yes	After <code>prod_test_58x.bin</code> has been downloaded to the DUTs, test commands can be sent to it. First the Windows DUTs COM ports are opened. Then a command to get the <code>prod_test_58x.bin</code> firmware version is sent to the devices. If there is a problem in the firmware or in the device, then this is the first failure to happen. The FW version get action will fail.
14	DA1458x	Current measure	Yes	Perform the Idle current measurement.
15	DA1458x	XTAL trim	Yes	Perform the XTAL trim procedure, if this is active.
16	DA1458x	XTAL trim OTP burn	Yes	If the 'Burn to OTP' option is selected in the CFG PLT, then the calculated XTAL trim value will be burned to the OTP Header.
17	DA1468x	UART resync	Yes	If the XTAL trim procedure was performed in the UART RX pin, then a special UART resync procedure takes place to resynchronize the device's UART RX path, as it may have entered into a baud rate error state due to the 500 ms received XTAL trim pulse.
18	DA1458x	BLE tester TX power	Yes	If the BLE tester TX Power test is active then perform the test using the external BLE tester instrument.
19	DA1458x	BLE tester TX carrier offset	Yes	If the BLE tester TX carrier offset test is active then perform the test using the external BLE tester instrument.
20	DA1458x	BLE tester TX modulation index	Yes	If the BLE tester TX modulation index test is active then perform the test using the external BLE tester instrument.
21	DA1458x	BLE tester RSSI	Yes	If the BLE tester RSSI test is active then perform the test using the external BLE tester instrument.
22	DA1458x	GU RSSI test	Yes	If the RSSI test using the GU as transmitter is active, then perform the test.
23	DA1458x	GPIO/LED	Yes	Perform the GPIO/LED test, if the test is active.
24	DA14582 only	Audio test	Yes	Perform the audio test, only for DA145482 and DA14585/6 devices and only if the particular test is enabled.

---



---

**DA1458x/DA1468x Production Line Tool**

Step	Device	Action	Opt	Description
25	DA1458x	Sensor test	Yes	Perform the sensor tests only if these are enabled.
26	DA1458x	Custom test	Yes	Perform any active custom test.
27	DA1458x	Current measure	Yes	Perform the Extended sleep current measurement.
28	DA1458x	Current measure	Yes	Perform the Deep sleep current measurement.
29	DA1458x	Firmware download	Yes	If any memory action is active (e.g. SPI Flash burn, erase etc.) download the <code>flash_programmer.bin</code> to the devices.
30	DA1458x	Open COM port and get the <code>flash_programmer.bin</code> version.	Yes	After <code>flash_programmer.bin</code> has been downloaded, commands can be sent. A command to get the <code>flash_programmer.bin</code> firmware version is sent to the devices.
31	DA1458x	SPI erase	Yes	Erase the SPI Flash, either entirely or part of it depending on the configuration.
32	DA1458x	SPI check empty	Yes	Depending on the configuration, check whether the SPI Flash is empty to verify the Flash erase procedure.
33	DA1458x	SPI image write	Yes	If enabled, write the SPI Flash with the customer image. If verify is enabled, the contents of the Flash will be read back and compared to the original image downloaded.
34	DA1458x	I2C EEPROM write	Yes	Write the I2C EEPROM with the customer image. If verify is enabled, the contents of the EEPROM will be read back and compared to the original image downloaded.
35	DA1458x	Custom memory data	Yes	Write custom memory data, taken from a barcode scanner, entered manually or through a CVS file.
36	DA1458x	OTP image write	Yes	Write the OTP image with the customer image. If verify is enabled, the contents of the OTP memory will be read back and compared to the original image downloaded.
37	DA1458x	OTP BD address write	Yes	If enabled, write the BD address into the OTP memory. If verify is enabled, the OTP BD address will be read back and compared to the original.
38	DA1458x	OTP BD address read	Yes	If enabled, the BD address from the OTP will be read. The BD address will be printed in GUI or CLI application. An additional test can be enabled to compare the read BD address with the one supplied by the tool.
39	DA1458x	OTP image write	Yes	Write the OTP image with the customer image. If verify is enabled, the contents of the OTP memory will be read back and compared to the original image downloaded.
40	DA1458x	OTP header write	Yes	If enabled, the OTP header fields will be burned.
41	DA1458x	Memory read	Yes	Up to ten memory read tests can be performed with up to 256 bytes in length.
42	DA1458x	Scan test	Yes	If enabled, the GU will scan for device BLE advertisements. For the DUTs to be scanned a valid firmware has to be burned into the OTP, SPI Flash or EEPROM that sends BLE advertisements after power up. Additionally, the BD address should be burned into the OTP by the PLT. The PLT expects to find devices in the air with the BD addresses programmed by the same tool, so it can match the BD addresses returned by the GU.

DA1458x/DA1468x Production Line Tool

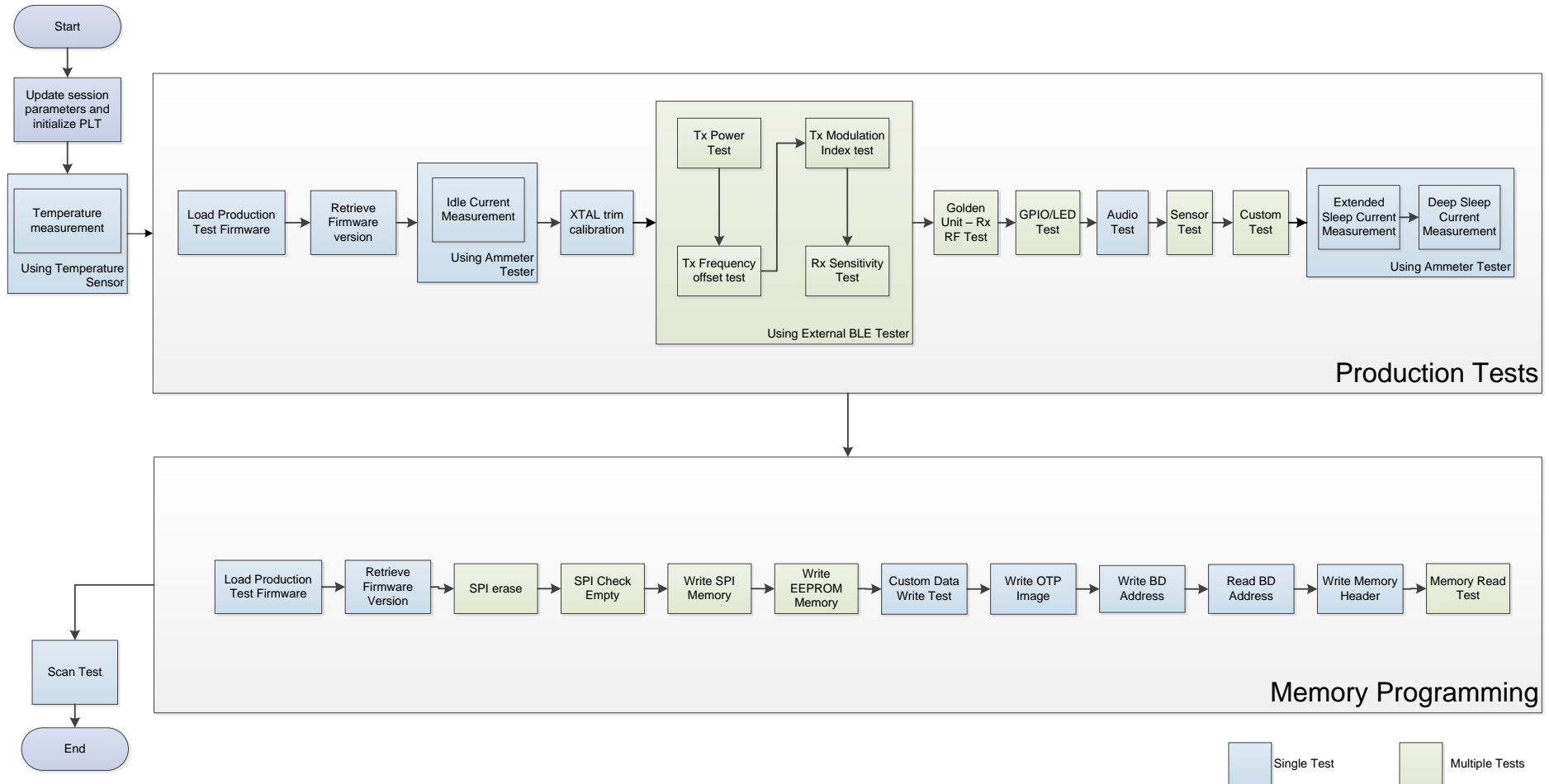

Figure 22: DA1458x Test Sequence

## DA1458x/DA1468x Production Line Tool

### 6.9.2 DA1468x Test Sequence

Table 14 describes each step that the PLT undertakes to validate and program DA1468x based devices. Some of the steps are optional and will only be executed if the equivalent actions are enabled in the configuration parameters. Additionally, some of the steps are supported only for specific DA1468x IC versions.

The entire test sequence for the DA1468x DUTs is shown in Figure 23.

**Table 14: DA1468x Test Sequence**

Step	Device	Action	Opt	Description
1	DA1468x	Statistics update	No	Update the total tests executed.
2	DA1468x	BD addresses	No	Update the BD addresses for all DUTs.
3	DA1468x	Configuration parameters	No	Configuration parameters are passed from the CLI or GUI to the <code>prod_line_tool_dll</code> . If any of the parameters is not valid an error will occur.
4	DA1468x	Reset GU	No	GU hardware reset by controlling an FT232 pin.
5	DA1468x	Initialize CPLD	No	The GU will set the CPLD to an initial known state.
6	DA1468x	Check temperature sensor instrument	Yes	Check whether the temperature measurement instrument is online, only if the temperature measurement test is active.
7	DA1468x	Check BLE tester instrument	Yes	Check whether the BLE tester instrument is online, only if any of the BLE tester test operations is active.
8	DA14681-00 only	Check voltage meter instrument	Yes	Check whether the voltage meter is online, only if the ADC gain calibration is active and only for DA14681-00 devices.
9	DA1468x	Check ammeter instrument	Yes	Check whether the ammeter instrument is online, only if any of the current measurement tests is active.
10	DA1468x	Toggle GU LED	No	Toggle the GU red LED on the PLT hardware to indicate that the GU is alive.
11	DA1468x	Check DUT COM ports	No	Check whether the PLT has identified the DUT COM ports and if not run the automatic DUT COM port identification.
12	DA1468x	Temperature measure	Yes	If the temperature measurement test is active, take a measurement and log it to all DUT logs and in the CSV file.
13	DA1468x	Download <code>prod_test_681_xx.bin</code>	Yes	If any of the production tests is active (e.g. RF tests, XTAL trim, etc.) download the <code>prod_test_68x_xx.bin</code> to the devices.
14	DA1468x	Open the devices COM ports and get the <code>prod_test_681_xx.bin</code> firmware version	Yes	After <code>prod_test_68x_xx.bin</code> has been downloaded, commands can be sent to it. First, the Windows DUTs COM ports are opened. Then, a command to get the <code>prod_test_68x_xx.bin</code> firmware version is send to the devices. If there is a problem in the firmware or in the device, then this is the first failure to happen. The FW version get action will fail.
15	DA1468x	Current measure	Yes	Perform the Idle current measurement.
16	DA1468x-00 only	ADC gain calibration	Yes	If this option is enabled and if the device is based on a DA14681-00 IC, then the ADC gain calibration procedure takes place using an external voltage meter instrument.
17	DA1468x	XTAL trim	Yes	Perform the XTAL trim procedure, if this is active.

## DA1458x/DA1468x Production Line Tool

Step	Device	Action	Opt	Description
18	DA1468x	UART resync	Yes	If the XTAL trim procedure was performed in the UART RX pin, then a special UART resync procedure takes place to resynchronize the device's UART RX path as it may have entered in a baud rate error state due to the 500ms received XTAL trim pulse.
19	DA1468x	BLE tester TX power	Yes	If the BLE tester TX Power test is active then perform the test using the external BLE tester instrument.
20	DA1468x	BLE tester TX carrier offset	Yes	If the BLE tester TX carrier offset test is active then perform the test using the external BLE tester instrument.
21	DA1468x	BLE tester TX modulation index	Yes	If the BLE tester TX modulation index test is active then perform the test using the external BLE tester instrument.
22	DA1468x	BLE tester RSSI	Yes	If the BLE tester RSSI test is active then perform the test using the external BLE tester instrument.
23	DA1468x	GU RSSI test	Yes	If the RSSI test using the GU as transmitter is active, then perform the test.
24	DA1468x	GPIO/LED	Yes	Perform the GPIO/LED test, if the test is active.
25	DA1468x	Sensor test	Yes	Perform the sensor tests only if these are enabled.
26	DA1468x	Custom test	Yes	Perform any active custom test.
27	DA1468x	Current measure	Yes	Perform the Extended sleep current measurement.
28	DA1468x	Current measure	Yes	Perform the Deep sleep current measurement.
29	DA1468x	Download <code>uartboot.bin</code>	Yes	If any of the memory actions is active (e.g. QSPI burn, QSPI erase, etc.) download the <code>uartboot.bin</code> to the devices.
30	DA1468x	Open COM port and get the <code>uartboot.bin</code> version.	Yes	After <code>uartboot.bin</code> has been downloaded, commands can be sent to it. A command to get the <code>uartboot.bin</code> firmware version is send to the devices.
31	DA1468x	QSPI erase	Yes	Erase the QSPI, either the entire or part of it depending on the configuration.
32	DA1468x	QSPI check empty	Yes	Depending on the configuration, check whether the QSPI is empty to verify the QSPI erase procedure.
33	DA1468x	QSPI image write	Yes	If enabled, write the QSPI with the customer image. If verify is enabled, the contents of the QSPI will be read back and compared to the original image downloaded.
34	DA1468x	QSPI BD address write	Yes	If enabled, the device BD address is programmed to a specific QSPI flash address.
35	DA1468x	QSPI BD address read	Yes	If enabled, the PLT will read the BD address field from the QSPI. This will be printed in the GUI, CLI screen and in the device logs. An additional test can be enabled to compare the read BD address to the one supplied by the tool.
36	DA1468x	QSPI XTAL trim write	Yes	If enabled, the XTAL trim value calculated during the XTAL trim calibration procedure will be burned into the QSPI flash.
37	DA1468x-00 only	QSPI ADC gain calibration write	Yes	If enabled, the ADC gain calibration value calculated during the calibration procedure will be burned into the QSPI flash.

---



---

**DA1458x/DA1468x Production Line Tool**

Step	Device	Action	Opt	Description
38	DA1468x	Custom memory data	Yes	Write custom memory data, taken from a barcode scanner, entered manually or through a CVS file.
39	DA1468x	OTP image write	Yes	Write the OTP image with the customer image. If verify is enabled, the contents of the OTP memory will be read back and compared to the original image downloaded.
40	DA1468x	OTP BD address write	Yes	If enabled, write the BD address into the OTP memory. If verify is enabled, the OTP BD address will be read back and compared to the original.
41	DA1468x	OTP BD address read	Yes	If enabled, the PLT will read the BD address field from the OTP. This will be printed in the GUI, CLI screen and in the device logs. An additional test can be enabled to compare the read BD address to the one supplied by the tool.
42	DA1468x	OTP XTAL trim write	Yes	If enabled, the XTAL trim value calculated during the XTAL trim calibration procedure will be burned into the OTP TCS header.
43	DA1468x-00 only	OTP ADC gain calibration write	Yes	If enabled, the ADC gain calibration value calculated during the calibration procedure will be burned into the OTP TCS header.
44	DA1468x	OTP header write	Yes	If enabled, the OTP header fields will be burned.
45	DA1468x	Memory read	Yes	Up to 10 memory read tests can be performed with up to 256 bytes in length.
46	DA1468x	Scan test	Yes	If enabled, the GU will scan for device BLE advertisements. For the DUTs to be scanned a valid firmware has to be burned into the OTP or QSPI flash that sends BLE advertisements after power up. Additionally, the BD address should be burned into the OTP or the QSPI by the PLT. The PLT expects to find devices in the air with the BD addresses programmed by the same tool, so it can match the BD addresses returned by the GU.

DA1458x/DA1468x Production Line Tool

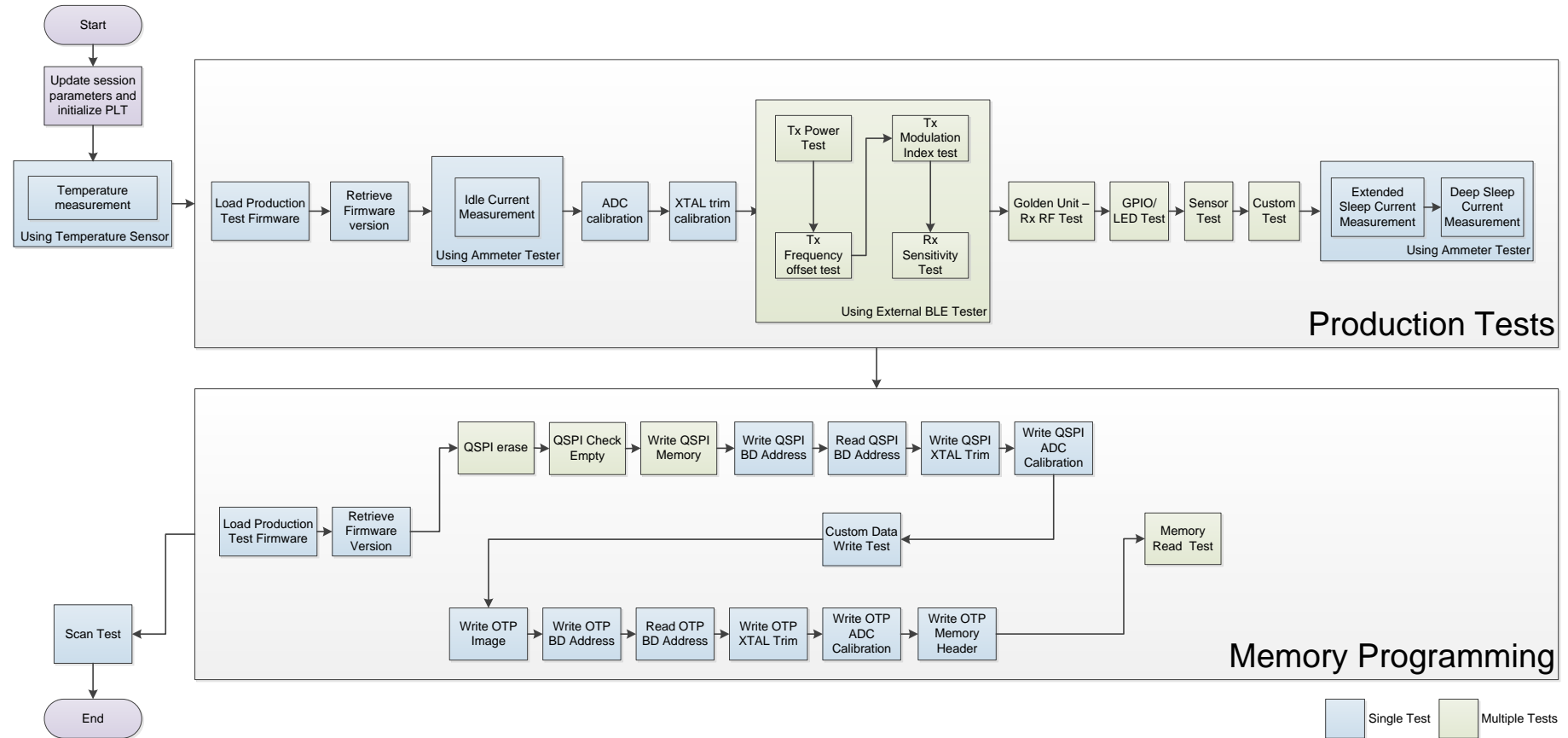

Figure 23: DA1468x Test Sequence



### 6.10 VBAT/Reset Signals Operation

The following chapter describes the PLT hardware VBAT and Reset signal operation during the DUT Test Sequence.

There are three different modes available to power and reset the DUTs using a combination of the PLT VBAT and Reset lines. These are described next.

#### 6.10.1 VBAT Only

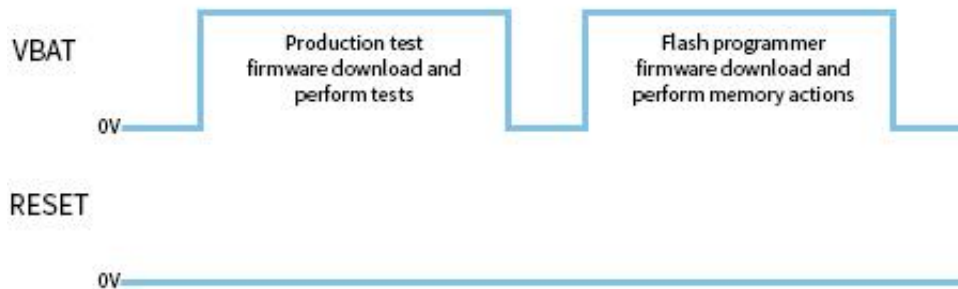

Figure 24: VBAT only

In this mode only the VBAT line is used as shown in Figure 24. Only the VBAT signal from the PLT hardware board to the DUT should be connected. The Reset signal is not driven. The DUTs are powered independently from their VBAT lines connected to the PLT HW and when reset is needed the PLT software toggles the VBAT line low in order to perform a POR to each device.

Battery powered DUTs or DUTs with an external power supply are not supported in this mode. PLT to DUT VBAT line connection is mandatory. PLT Reset line connection is not required.

#### Firmware download

When the firmware download procedure begins, the PLT VBAT line will power the DUTs and the UART connections will open, which will result to a POR for all active devices. This POR will activate the DUTs UART booting procedure and the PLT software will be able to download a test firmware.

If there are devices that failed the test firmware download procedure, the PLT will perform a VBAT POR to retry the firmware download procedure only for those that failed. During the extra attempts to download firmware to the failed devices, the VBAT lines of the devices that succeeded will remain active. After three retry attempts the PLT VBAT lines will remain active only for the devices that have succeeded.

When the production testing has finished the above procedure will be repeated for the memory programming as a different firmware needs to be downloaded to the DUTs.

#### Current measurement

Since the DUTs will be powered through the PLT HW, using the VBAT line, then the [Current Measurement Test](#) for the DA14580/1/2/3/5/6 and the [Current Measurement Test](#) for the DA14681/2/3 are supported using an external multi meter as described in [Current Measurements](#).

DA1458x/DA1468x Production Line Tool

6.10.2 VBAT On with Reset

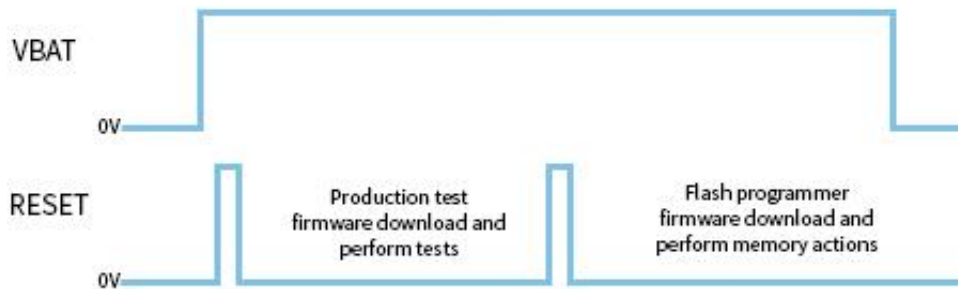

Figure 25: VBAT On with Reset

In this mode the reset of the DUTs will be performed by the PLT Reset line as shown in Figure 25. During this mode the PLT VBAT line continuously provides power to the DUTs and the DUTs are reset using the PLT Reset line.

Power supply can be provided to the DUTs if the PLT VBAT line is connected to the DUTs. However, for battery powered DUTs or for DUTs with an external power supply VBAT should not be connected. For such devices, only the connection to the PLT Reset line is mandatory.

Firmware download

When the firmware download procedure begins, the PLT will reset the DUTs using the PLT Reset line. The VBAT line is already active and remains active for the entire PLT test and memory programming procedure. If there are devices that failed to download firmware, the PLT will reset all the DUTs again and retry to download firmware to all of them even if these have succeeded. This is different approach from the VBAT Only procedure, since the Reset line is a single hardware line that cannot be differently controlled for each DUT, as opposed to the VBAT lines.

When the production testing has finished, the above procedure will be repeated for the memory programming as a different firmware needs to be downloaded to the DUTs.

Current measurement

If the DUTs are powered through the PLT HW, using the VBAT line, or if they are powered using a single common line from an external power supply, then the Current Measurement Test for the DA14580/1/2/3/5/6 and the Current Measurement Test for the DA14681/2/3 are supported using an external multi meter as described in Current Measurements. If the DUTs are powered independently or have their own power supply (e.g. battery) then the Current measurement tests are not supported.

6.10.3 VBAT as Reset

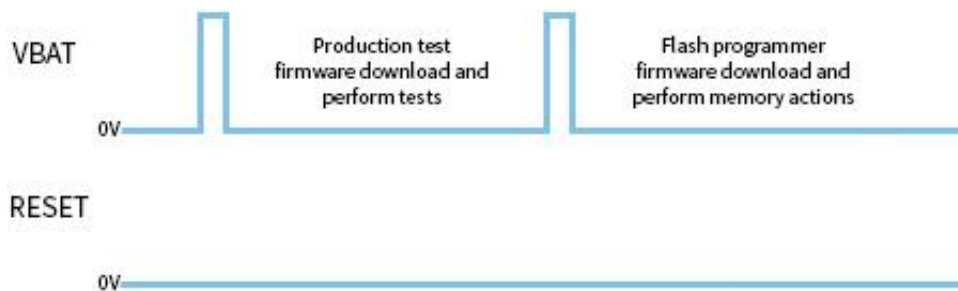

Figure 26: VBAT as Reset

In this mode the reset of the DUTs will be performed using the PLT VBAT line as shown in Figure 26. Each DUT can be reset independently using the VBAT lines. This mode has advantage over VBAT On with Reset since VBAT lines can independently be controlled as opposed to the PLT Reset line.

**DA1458x/DA1468x Production Line Tool**

This mode supports only devices that are battery powered or have an external power supply and are already powered on. PLT VBAT line connection is mandatory and it must be connected to the DUT reset pin. The PLT Reset line connection is not used.

**Note:** When using this mode the PLT VPP signal used for programming the OTP memory (OTP header and burning the XTAL Trim to OTP during production testing for the DA14580/1/2/3 devices) is not supported. An external VPP supply (as described in [Table 2](#)) should be provided when using this mode.

**Firmware download**

When the firmware download procedure begins, the UART connections will open and the PLT VBAT lines will be used to reset the DUTs.

If there are devices that failed the firmware download procedure, the PLT will perform a reset (using the VBAT line of each DUT) to retry for those DUTs that failed. After three attempts the UART connections will remain on only for the devices that have firmware loaded.

When the production testing has finished, the above procedure will be repeated for the memory programming as a different firmware needs to be downloaded to the DUTs.

**Current measurement**

If the DUTs are powered using a single common line from an external power supply, then the [Current Measurement Test](#) for the DA14580/1/2/3/5/6 and the [Current Measurement Test](#) for the DA14681/2/3 are supported using an external multi meter as described in [Current Measurements](#). If the DUTs are powered independently or have their own power supply (e.g. battery) then the Current measurement tests are not supported.

**6.11 Custom Memory Data**

The following chapter describes the PLT 'Custom Memory Data' configuration and programming procedure.

The PLT supports programming custom user data of any size up to 256 bytes, to any memory and from any start address. Custom data can be entered to the PLT by the three input methods described in [Table 15](#).

**Table 15: Custom Memory Data Input Modes**

Input Modes	Description
Barcode scanner	Prior of starting the PLT tests, before pressing the START button in the PLT GUI, users can use a barcode scanner to enter custom memory data, different for each DUT. A new GUI screen can be used to scan DUT barcodes and save the barcode scanned data to the PLT. The PLT will then burn these data to the user specified memory and address. Duplicate scan data protection can be enabled to protect scanning same data for different DUTs in the same test.
CSV file	Users can provide a path to a CSV file that will contain the custom memory data for each DUT. The format of the CSV file is specific and is provided in <a href="#">Custom data CSV file format</a> .
Manual	Users can manually edit the custom memory data prior of each PLT test run. The edit can be done in the PLT GUI or in the <code>params.xml</code> file using an external application or script. If different data per DUT is required then the update of the custom memory data should be done before every PLT test run.

Chapter [Custom Memory Data](#) explains in detail the various configuration parameters of the 'Custom Memory Data' programming PLT feature.

**6.11.1 Homekit Hash Setup Code**

The PLT supports the hashing and programming of homekit setup codes. This feature is only supported for the DA14681/2/3 DUTs and can be enabled in the [Custom Memory Data](#) test using the

DA1458x/DA1468x Production Line Tool

Homekit binary generator option. For this to work users should input to the PLT a specific format of the setup code and device serial number. The format should be as described in [Table 16](#).

**Table 16: Homekit Setup Code Format**

Homekit Setup Code format	Description
XXXXXXXXZZZZZ.....Y	<p>XXXXXXXX is an exact 8 digit homekit setup code without the dashes.                      ZZZZZZ..... is the serial number with a maximum length of 64 characters.                      Y is the checksum of the previous characters.</p> <p>Example:                      Consider a device with setup code 123-45-678 and serial number DIAG97969594. The input to the PLT should be given as 12345678DIAG97969594P</p> <p>The final character 'P' is the checksum of the previous characters. The algorithm of the checksum is given in <a href="#">Table 17</a>.</p>

The homekit setup code characters can be taken from either input mode described in [Table 15](#). The PLT will read the input and will apply it as input argument to the `SetupCode_Generator_680.exe` application found under the `binaries` folder. The `SetupCode_Generator_680.exe` application will create, in the same `binaries` folder, a binary image with the name `XXXXXXXXZZZZZ.....Y.bin`. The PLT will burn this file to the memory and start address that the user has configured.

**Table 17: Homekit Setup Code Checksum Algorithm**

Homekit Setup Code Checksum Algorithm
<pre> const char checkCharList[] = "0123456789ABCDEFGHIJKLMNPOQRSTUVWXYZ"; /**  *  * @brief Homekit specific setup code and serial number checksum check function.  * This checksum algorithm is similar to EAN, ILN and NVE but with alphanumeric instead of numbers  *  * @param[in] *inString          The string to check its checksum.  * @param[in] *inLength         The length of the string.  *  * @return The checksum character.  */ char hmkt_setupcode_chksm(const char *inString, int inLength) {     char check = 0;     int index = 0;     unsigned int sum = 0;     const char *characters = inString;      for (index=0; index&lt;inLength &amp;&amp; characters[index]!=0; index++) {         if ((index % 2) == 0)             sum += characters[index];         else sum += characters[index] * 3;     }      sum = sum % 36;      if (sum != 0)         sum = 36 - sum;      check = checkCharList[sum];      return check; } </pre>



### DA1458x/DA1468x Production Line Tool

Figure 27 shows an example of a CSV file targeted for DA14580 DUTs. In this particular example the CSV file contains information for DUTs with BD addresses 80:EA:CA:80:00:01 to 80:EA:CA:80:00:13. For BD addresses 80:EA:CA:80:00:04-05 there are three tests and two for the rest.

The first test, which is similar for all BD addresses with only the Data field to be different, is to write in the OTP Header memory of the DA14580 DUTs five bytes, in OTP address 0x47F54 (OTP Customer field).

The second test is identical for all DUTs. It is configured to write into the SPI flash address 0x8000 10 bytes (0x112233445566778899AA).

Finally the third test will only apply for BD addresses 80:EA:CA:80:00:04 and 80:EA:CA:80:00:05. This will write 256 bytes of data in address 0x9000 of the SPI flash memory.

### 6.12 Golden Unit Scan Test

This section describes the PLT Scan test procedure using the Golden Unit as scanner device.

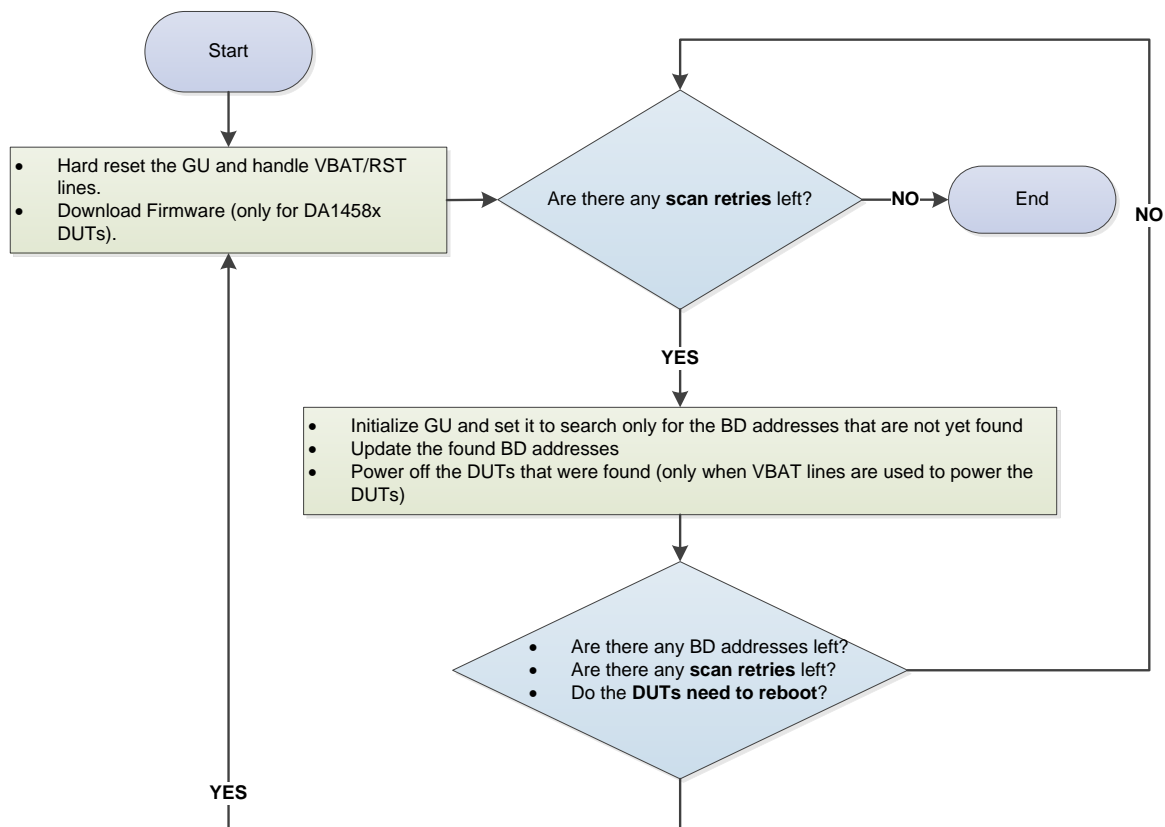

Figure 28: Golden Unit Scan Test

User can set various scan properties to adjust the Scan test procedure. The available properties that apply to the DA1458x devices are described Table 51 and for the DA1468x devices in Table 79.

Figure 28 shows the Scan sequence. First the Golden Unit and the DUTs are reset. At this stage if the *Firmware load enable* is active (option is available only in DA1458x DUTs) the PLT will download the selected firmware. Then the Golden Unit will begin scanning for the BD addresses of all active DUTs. After each Scan cycle, the already found BD addresses are removed from the search list of the Golden Unit and the appropriate DUTs will be powered off. This procedure will continue until the retries have reached the *Scan retries* set by the user. The PLT will reset the Golden Unit after a specific number or retries, given in *DUT reboot* option. Finally, the parameters *DUT reboot time* and

DA1458x/DA1468x Production Line Tool

DUT reboot difference set the DUT time needed to perform a POR with a small delay between the DUTs if needed.

Enable

Scan retries

DUT reboot

DUT reboot difference

DUT reboot time

Firmware load enable

Firmware path

Figure 29: Golden Unit Scan Test Example Parameters

Figure 29 shows an example for DA1580 DUT connected with VBAT only mode as described in VBAT/Reset Signals Operation. For this example the following steps will be executed.

- Reset the Golden Unit, power off the DUTs and wait for 2500ms. Power on and load prox\_reporter\_580.bin firmware to each DUT with a 37 ms time difference between them.
- Execute three Golden Unit scan procedures. After each scan procedure is finished power off the found DUTs.
- Again Reset the Golden Unit, power off the DUTs and wait for 2500ms. Power on and load prox\_reporter\_580.bin firmware to each DUT with a 37 ms time difference between them.
- Continue with another three Golden Unit scan procedures and after each scan procedure power off the found DUTs.

6.13 Creating Firmware Files under “binaries” Folder

In order for the PLT to work various firmware are used, based on the device type (Golden Unit or DUT), the chipset flavor (DA14580/1/2/3/5/6 or DA146801/2/3) or the purpose of the firmware (different firmware for production tests and for memory programming).

All these firmware are kept under the binaries folder on the PLT software package as shown in Figure 30. In order to create these firmware, the default SDK packages can be used, downloaded from the customer portal, and then apply to them the source code patches located under the fw\_files folder in the PLT software package, shown in Figure 31.



## DA1458x/DA1468x Production Line Tool

Name	Date modified	Type	Size
GU	9/10/2017 7:03 μμ	File folder	
pxp_reporter_683_00.bin.cached	22/8/2017 5:36 μμ	CACHED File	79 KB
pxp_reporter_681_01.bin.cached	22/8/2017 5:36 μμ	CACHED File	81 KB
pxp_reporter_681_00.bin.cached	4/7/2017 4:56 μμ	CACHED File	118 KB
uartboot_681_01.bin	14/9/2017 11:53 πμ	BIN File	24 KB
uartboot_681_00.bin	28/11/2016 2:35 μμ	BIN File	15 KB
prox_reporter_585.bin	4/7/2017 4:56 μμ	BIN File	26 KB
prox_reporter_580.bin	4/7/2017 4:56 μμ	BIN File	27 KB
prod_test_683_00.bin	22/8/2017 4:15 μμ	BIN File	61 KB
prod_test_681_01.bin	22/8/2017 4:54 μμ	BIN File	63 KB
prod_test_681_00.bin	18/11/2016 10:20 πμ	BIN File	54 KB
prod_test_585_def.bin	4/7/2017 4:56 μμ	BIN File	19 KB
prod_test_585.bin	4/10/2017 2:08 μμ	BIN File	24 KB
prod_test_582.bin	4/7/2017 12:19 μμ	BIN File	27 KB
prod_test_581.bin	4/7/2017 12:19 μμ	BIN File	20 KB
prod_test_580.bin	4/7/2017 11:45 πμ	BIN File	24 KB
flash_programmer_585.bin	4/7/2017 1:09 μμ	BIN File	9 KB
flash_programmer_580.bin	4/7/2017 4:56 μμ	BIN File	8 KB
ble_app_barebone_580.bin	30/6/2017 3:58 μμ	BIN File	18 KB

**Figure 30: Binaries**

The source code patches maintain the folder structure of the SDK they are targeting, in order to apply the source code patch using a simple copy and replace to the files needed. After that the projects contain all the necessary changes and the same firmware can be built as those in the binaries folder of the PLT software package.

The “fw\_files” folder has two main categories. Firmware targeted for the Golden Unit and for the DUTs. Under each category there is a folder indicating the IC target and then the SDK that is used.

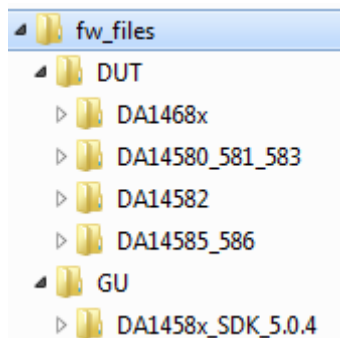

**Figure 31: “fw\_files” Folder Contents**

Applying a source code patch for each one of the binaries is described below.

### Golden Unit – Production Test Firmware

The Golden Unit is a DA1580 device. A modified version of the `prod_test_580.bin` firmware is used.

This patch contains all the changes needed to re-create the following firmware:

- `prod_test_GU.bin`

In order to re-create the exact source code of the `prod_test_GU.bin` firmware:

1. Use a clean copy of the DA1458x\_SDK\_5.0.4 SDK from the customer portal.
2. Copy all the contents from the “...\fw\_files\GU\DA1458x\_SDK\_5.0.4\DA1458x\_SDK\5.0.4\” folder to the default SDK.
3. The Keil v5 project file of the `prod_test_GU.bin` is the “`prod_test.uvprojx`” under the folder “\5.0.4\projects\target\_apps\prod\_test\prod\_test\Keil\_5\”.

## DA1458x/DA1468x Production Line Tool

### DA14580/1/2/3 – Production Test Firmware, Flash Programmer Firmware, Proximity Reporter, BLE App Barebone

This patch contains all the changes needed to re-creates the following firmwares:

- prod\_test\_580.bin
- prod\_test\_581.bin
- flash\_programmer\_580.bin
- prox\_reporter\_580.bin
- ble\_app\_barebone\_580.bin

**Note:** Due to functional differences between the DA14580 and DA14581 chips, a different production test firmware for each IC is needed.

**Note:** Because DA14582 supports Audio test, another patch must be applied over this, in order to create a production test firmware that supports audio test for the DA14582 DUTs, as described later.

In order to re-create the exact source code of the above firmwares:

1. Use a clean copy of the DA1458x\_SDK\_5.0.4 SDK from the customer portal.
2. Copy all the contents from the “...\fw\_files\DUT\DA14580\_581\_583\DA1458x\_SDK\_5.0.4\DA1458x\_SDK\5.0.4” folder to the default SDK.
3. The Keil v5 project file of the prod\_test\_580.bin and prod\_test\_581.bin is the “prod\_test.uvprojx” under the folder “\5.0.4\projects\target\_apps\prod\_test\prod\_test\Keil\_5\”. To select between the DA14580 and DA14581 there is a “Select Target” option next to the project properties.
4. The Keil v5 project file of the flash\_programmer\_580.bin is the “programmer.uvprojx” under the folder “\5.0.4\utilities\flash\_programmer\”. Make sure that “programmer\_uart” option is selected under “Select Target”.
5. The Keil v5 project file of the prox\_reporter\_580.bin is the “prox\_reporter.uvprojx” under the folder “\5.0.4\projects\target\_apps\ble\_examples\prox\_reporter\Keil\_5\”.
6. The Keil v5 project file of the ble\_app\_barebone\_580.bin is the “ble\_app\_barebone.uvprojx” under the folder “\5.0.4\projects\target\_apps\ble\_examples\ble\_app\_barebone\Keil\_5\”.

**Note:** The PLT uses the same firmware for DA14583 and DA14580, so there is no need for a different production test binary.

### DA14582 – Production Test Firmware supporting Audio test

This patch contains all the changes needed to re-creates the following firmwares:

- prod\_test\_582.bin

**Note:** This patch requires applying the [DA14580/1/2/3 – Production Test Firmware, Flash Programmer Firmware, Proximity Reporter](#) patch first.

In order to re-create the exact source code of the above firmware:

1. Use the modified SDK version as described in the above section.
2. Copy all the contents from the “...\fw\_files\DUT\DA14582\DA1458x\_SDK\_5.0.4\DA1458x\_SDK\5.0.4” folder to the current SDK.
3. The Keil v5 project file of the prod\_test\_582.bin is the “prod\_test.uvprojx” under the folder “\5.0.4\projects\target\_apps\prod\_test\prod\_test\Keil\_5\”. In “Select Target” option select the “prod\_test\_580”, “clean” and “build” the project.

---

**DA1458x/DA1468x Production Line Tool**
**DA14585/6 – Production Test Firmware, Flash Programmer Firmware, Proximity Reporter**

This patch contains all the changes needed to re-creates the following firmwares:

- prod\_test\_585.bin
- flash\_programmer\_585.bin
- prox\_reporter\_585.bin

In order to re-create the exact source code of the above firmwares:

1. Use a clean copy of the DA14585\_SDK\_6.0.4.326 from the customer portal.
2. Copy all the contents from the “...\fw\_files\DUT\DA14585\_586\DA14585\_SDK\_6.0.4.326\DA14585\_SDK\6.0.4.326\” folder to the default SDK.
3. The Keil v5 project file of the prod\_test\_585. bin is the “prod\_test.uvprojx” under the folder “\6.0.4.326\projects\target\_apps\prod\_test\prod\_test\Keil\_5\”.
4. The Keil v5 project file of the flash\_programmer\_585.bin is the “programmer.uvprojx” under the folder \6.0.4.326\utilities\flash\_programmer\”. **Make sure that “programmer\_uart” option is selected under “Select Target”.**
5. The Keil v5 project file of the prox\_reporter\_585.bin is the “prox\_reporter.uvprojx” under the folder “\6.0.4.326\projects\target\_apps\ble\_examples\prox\_reporter\Keil\_5\”.

**DA14681/2/3 – Production Test Firmware, Uartboot Firmware, Proximity Reporter**

This patch contains all the changes needed to re-creates the following firmware:

- prod\_test\_681\_01.bin
- prod\_test\_683\_00.bin
- uartboot\_681\_01.bin
- pxp\_reporter\_681\_01.bin.cached
- pxp\_reporter\_683\_00.bin.cached

In order to re-create the exact source code of the above firmwares:

1. Use a clean copy of the DA1468x\_DA15xxx\_SDK\_1.0.10.1072 from the customer portal.
2. Copy all the contents from the “...\fw\_files\DUT\DA1468x-DA15xxx\DA1468x\_DA15xxx\_SDK\_1.0.10.1072\” folder to the default SDK.
3. The Smart Snippets Studio project file of the prod\_test\_681\_01.bin and prod\_test\_683\_00.bin is the “plt\_fw” under the folder “...\DA1468x\_DA15xxx\_SDK\_1.0.10.1072\projects\dk\_apps\reference\_designs\plt\_fw”. To create each binary, select from the drop down menu the “Release RAM” option for each chip.
4. The Smart Snippets Studio project file of the uartboot\_681\_01.bin is the “uartboot” under the folder “...\DA1468x\_DA15xxx\_SDK\_1.0.10.1072\sdk\bsp\system\loaders\uartboot\”. To create the binary, select from the drop down menu the “Release” option.
5. The Smart Snippets Studio project file of the pxp\_reporter\_681\_01.bin.cached and pxp\_reporter\_683\_00.bin.cached is the “pxp\_reporter” under the folder “...\DA1468x\_DA15xxx\_SDK\_1.0.10.1072\projects\dk\_apps\demos\pxp\_reporter\”. To create each binary, select from the drop down menu the “QSPI\_Release” option for each chip.

Each binary will be created under the project folder in a folder having the same name as the selected option.

---

**DA1458x/DA1468x Production Line Tool**

**Note:** The `pxp_reporter` source code generates a `.bin` file. In order to write it to the QSPI Flash memory and boot from it, a `.cached` version of the binary must be created using the `"bin2image.exe"`. See [0](#) for more details.

## 7 Applications

### 7.1 Introduction

The PLT software includes three different applications (Table 5). The CFG PLT is used to setup the system according to the device hardware options and select the required tests and memory actions to be performed. The GUI and the CLI PLT applications are used to perform the tests, monitor their progress in real-time and view the test results.

### 7.2 CFG PLT Application

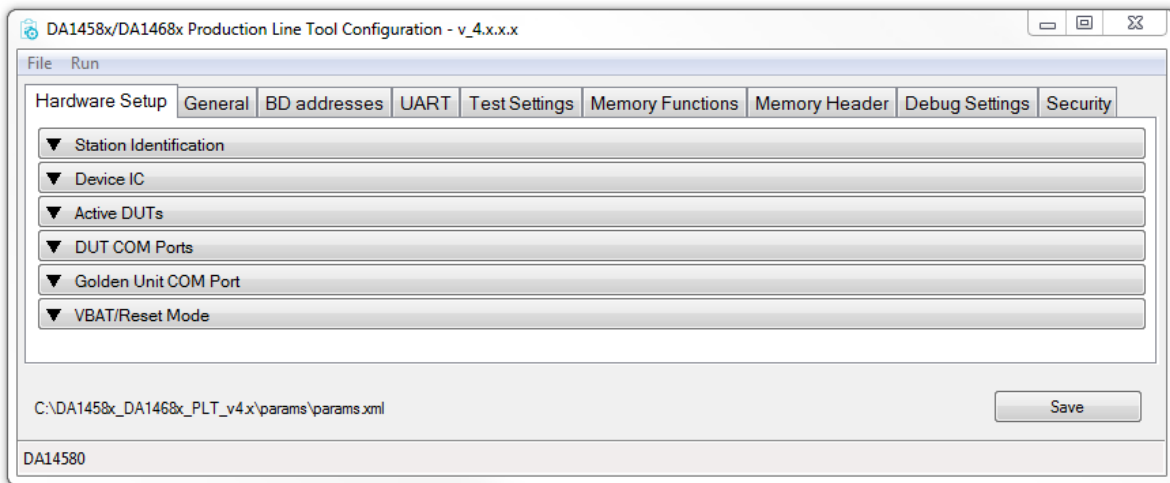

**Note 1** Each Hardware Setup field can be minimized by clicking on it, but it will not be disabled. The tests will run if they are enabled, even when the test field is minimized and not shown.

**Figure 32: CFG PLT Startup Screen**

The CFG PLT application (DA1458x\_DA1468x\_CFG\_PLT.exe) is a GUI application tool, which is mainly used to appropriately configure the tests and memory operations the tool will perform. Depending on the selected device chipset and the enabled actions, only appropriate options are enabled and shown. Any change made by the user is validated before being saved to the XML file, with the use of a schema XSD file. This prevents erroneous values to be stored in the XML file that would harm the production procedure.

Figure 32 shows the initial CFG PLT screen. The Main Menu options are described in Table 18 and the bottom strip information is described in Table 19. The application begins with the **Hardware Setup** tab (see section 7.2.2). Users can navigate to the other PLT configurable options by selecting the different tabs.

When a tab is selected, the settings of this tab are reloaded from the XML file. If there is an error in the configuration file for a specific parameter, a warning message will be shown indicating which of the parameters has error. Additionally, the related graphic entry in the CFG application for the erroneous configuration parameter will be highlighted in red.

An example is given in Figure 33. Configuration parameter `dut_num_1` has wrong value (error instead of either `false` or `true`) in the `params.xml` file. When the **Hardware Setup** CFG tab is selected the Warning message will be displayed and if **OK** is pressed the **Hardware Setup** tab will be loaded with the DUT 1 checkbox in red and the displayed value will be the default value taken from the XML schema document (`params.xsd`).

DA1458x/DA1468x Production Line Tool

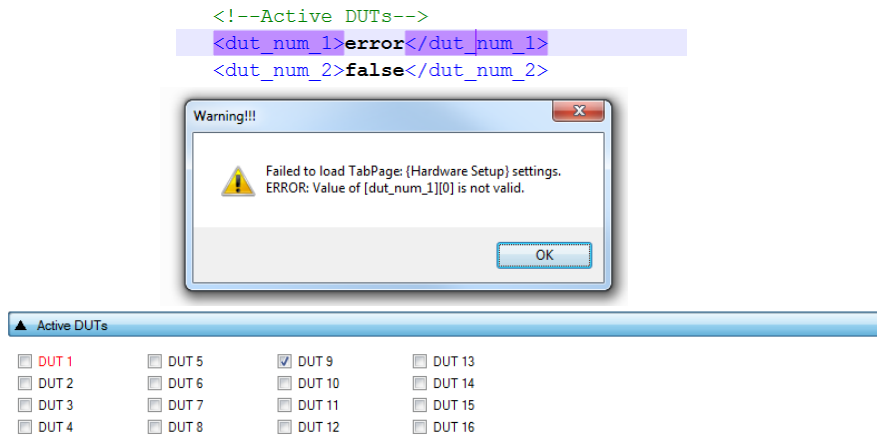

Figure 33: CFG PLT with Erroneous Configuration Parameter

When the user makes a change, the **Save** button will become **Save\*** to indicate that a save is required.

In case of a configuration parameter error, pressing **Save** will save the default parameter value, overwriting the erroneous value.

Table 18: CFG PLT Main Menu Options

Region	Option	Description
File	Open XML file	Opens a new XML file and loads its settings. The full path of the new XML file is shown at the bottom end of the screen.
	View XML file	Opens the XML file in notepad.
	Save as...	Exports all settings to a new XML file. The full path of the new XML file is shown at the bottom end of the screen.
	Reset to defaults	Overwrites all parameters options in the XML file with their default values taken from the XSD file.
	Exit	Exits the CFG PLT application.
Run	Run GUI PLT	Opens the GUI PLT application.
	Run CLI PLT	Opens the CLI PLT application.

Table 19: CFG PLT Bottom Strip Options

Option	Description
C:\Release\params\params.xml	Shows the full path of the XML file that is currently used.
DA14580	Shows the selected device IC.
Save	Saves all the options of the currently selected tab. E.g. If General settings tab is selected, then only the settings for this tab will be saved.

7.2.1 XML and XSD Files

The CFG PLT application is a front-end user interface for the `cfg_dll.dll` library (Figure 20). The `cfg_dll.dll` library, explained in detail in Ref. [1], is an XML parser, editor and parameter validator. It has an easy-to-use API for reading and manipulating the `params.xml` file. File `params.xsd` is the XML schema used for parameter validation.

DA1458x/DA1468x Production Line Tool

In the CFG PLT application all user selectable options are loaded and saved inside the XML file, by effectively using the `cfg_dll.dll` library API. The XSD schema file `params.xsd` is not edited in any way but only read by the `cfg_dll.dll` library API, whenever parameter validation is needed.

The `params.xml` file is separated into three main parts as explained in [Table 20](#).

Table 20: XML File Parts

Part Name	Example	Description
Common part	<pre>&lt;programming_enable&gt;true&lt;/programming_enable&gt; &lt;tests_enable&gt;true&lt;/tests_enable&gt; &lt;retest_failed&gt;&gt;false&lt;/retest_failed&gt; &lt;!-- --&gt; &lt;!-- BD Addresses --&gt; &lt;!-- --&gt; &lt;bd_addr_mode&gt;0&lt;/bd_addr_mode&gt; &lt;bd_addr_file_path&gt;params\bd_address.ini&lt;/bd_addr_file_path&gt; &lt;start_bd_addr&gt;00:00:00:00:01&lt;/start_bd_addr&gt; &lt;next_bd_addr&gt;00:00:00:00:01&lt;/next_bd_addr&gt; &lt;end_bd_addr&gt;00:00:00:00:01&lt;/end_bd_addr&gt; &lt;scanner_iface&gt;COM21&lt;/scanner_iface&gt; &lt;scan_mode_auto&gt;1&lt;/scan_mode_auto&gt;</pre>	The main top part of the XML file contains parameters common to any DUT, like the BD address mode, the COM ports and which device is enabled or disabled. It also holds the debug parameters, the test statistics and the test station name used in the logs.
DA1458x	<pre>&lt;!-- DA1458x --&gt; &lt;config_params_da1458x&gt;   &lt;!-- --&gt;   &lt;!-- UART --&gt;   &lt;!-- --&gt;   &lt;uart_boot_pins&gt;4&lt;/uart_boot_pins&gt;   &lt;uart_change_pins&gt;&gt;false&lt;/uart_change_pins&gt;   &lt;uart_pin_tx&gt;P0_4&lt;/uart_pin_tx&gt;   &lt;uart_pin_rx&gt;P0_5&lt;/uart_pin_rx&gt;   &lt;uart_baud_rate&gt;1000000&lt;/uart_baud_rate&gt;</pre>	The second XML part, with the element name <code>config_params_da1458x</code> , holds parameters used by DA1458x devices. Under this part all the test and the memory action settings are stored.
DA1468x	<pre>&lt;!-- DA1468x --&gt; &lt;config_params_da1468x&gt;   &lt;!-- --&gt;   &lt;!-- UART --&gt;   &lt;!-- --&gt;   &lt;uart_boot_pins&gt;4&lt;/uart_boot_pins&gt;   &lt;uart_baud_rate&gt;1000000&lt;/uart_baud_rate&gt;   &lt;!-- --&gt;</pre>	The third and final XML part, with the element name <code>config_params_da1468x</code> , holds parameters used by DA1468x devices. Under this part all the test and the memory action settings are stored.

The XSD schema file, `params.xsd`, holds information about the overall structure of the `params.xml` file, the default and valid values a parameter can take and useful help information about the purpose of each parameter. An example part of the XSD file is given in [Figure 34](#).



DA1458x/DA1468x Production Line Tool

```

<xs:element name="next_bd_addr"
  type="x:cfg_hex_array_6_bytes"
  x:use="required"
  x:default="00:00:00:00:00:01"
  x:info="The BD address of the first active DUT that will be used in the next test run. "/>
<!--cfg_hex_array_6_bytes-->
<xs:simpleType name="cfg_hex_array_6_bytes">
  <xs:restriction base="xs:string">
    <xs:pattern value="([0-9A-Fa-f][0-9A-Fa-f][0-9A-Fa-f])(:([0-9A-Fa-f][0-9A-Fa-f][0-9A-Fa-f])){5}"/>
  </xs:restriction>
</xs:simpleType>

<xs:element name="RF_path_loss_DUT_1"
  type="x:cfg_dut_path_losses"
  x:use="required"
  x:default="0"
  x:info="Set the RF path losses in dB between the device and the GU or the BLE tester instrument."/>
<!--cfg_dut_path_losses-->
<xs:simpleType name="cfg_dut_path_losses">
  <xs:restriction base="xs:float">
    <xs:minInclusive value="0"/>
    <xs:maxInclusive value="40"/>
  </xs:restriction>
</xs:simpleType>

```

Figure 34: XSD Schema File Example

Element `next_bd_addr` holds the Next BD address, as described in section 7.2.4.1 and Table 29. It has a default value of `x:default="00:00:00:00:00:01"`. This default value will be returned by the `cfg_dll.dll` API if the XML file has an error entry in the equivalent `next_bd_addr` element, since the validation of the parameter will fail.

The `x:info="The BD address ..."` value will be loaded by the `cfg_dll.dll` API and be used in the CFG PLT tooltips. The `type="x:cfg_hex_array_6_bytes"` defines the parameter type. This is the actual XSD entry that is used for the parameter validation. The `cfg_hex_array_6_bytes` type is defined later in the file and has a rather complicated pattern defined with `<xs:pattern value="([0-9A-Fa-f][0-9A-Fa-f][0-9A-Fa-f])(:([0-9A-Fa-f][0-9A-Fa-f][0-9A-Fa-f])){5}"/>`. If the `next_bd_addr` element in the XML file has a value that does not match this pattern, the validation of the parameter will fail and the `cfg_dll.dll` API will return the default value (00:00:00:00:00:01). In the CFG PLT, the default value will be shown in red, indicating that an error exists in the `params.xml` file for this parameter. It will not change the erroneous value in the `params.xml` file until the user presses the **Save** button, in which case the default value will overwrite the erroneous value.

In the second example of Figure 34, the `RF_path_loss_DUT_1` XSD element is shown. This element is used in the `Path Losses per DUT` as shown in Figure 57. This element has a default value of 0 and the allowed values are floats, between `<xs:minInclusive value="0"/>` and `<xs:maxInclusive value="40"/>`, as shown in the `cfg_dut_path_losses` type description. The `x:info="Set the RF path ..."` will be loaded by the `cfg_dll.dll` API and used in the CFG PLT tooltips as shown in the bottom part of Figure 34.

7.2.2 Hardware Setup

This section describes the Hardware Setup settings available for the PLT hardware board, as shown in Figure 32.

DA1458x/DA1468x Production Line Tool

7.2.2.1 Station Identification

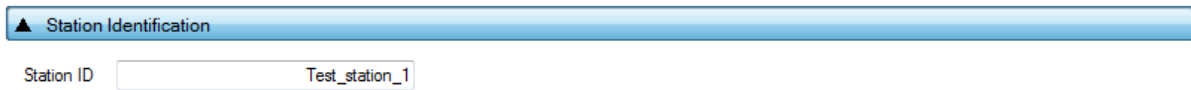

Figure 35: Station Identification

This field holds a name given by the user to distinguish between different test stations. The value of this field is written into the DUT log files. Table 21 describes the available options for the *Station Identification*.

Table 21: Station Identification

Option	Description
Station ID	The name of the PLT test station.

7.2.2.2 Device IC

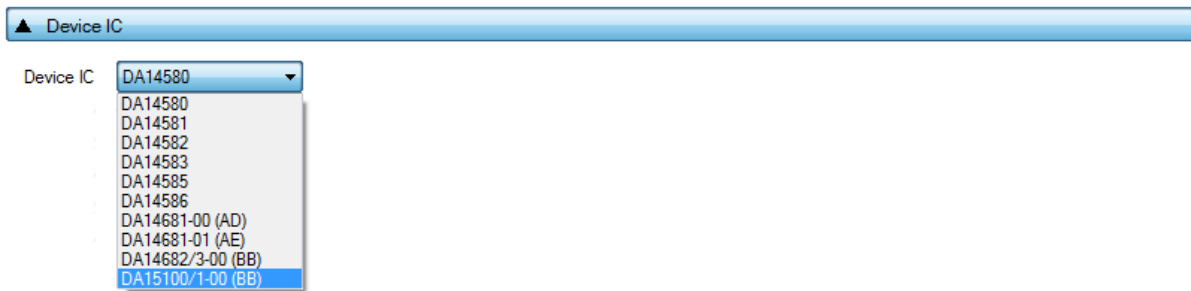

Figure 36: Device IC

Users can select the device IC type. This option will also change any IC related graphics, such as selectable tabs and tests. Table 22 describes the available options for the *Device IC*.

Table 22: Device IC

Option	Description
Device IC	The Dialog BLE chipset used in the device under test.

7.2.2.3 Active DUTs

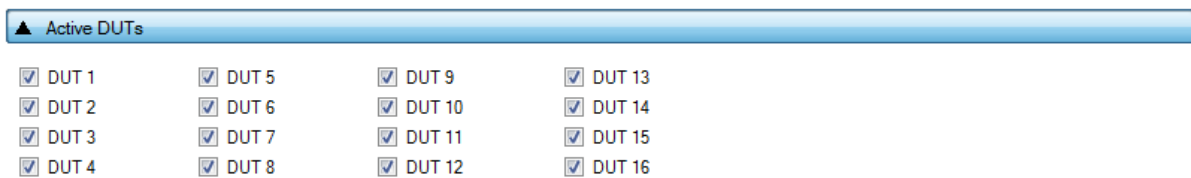

Figure 37: Active DUTs

Enables or disables the testing for each DUT. Table 23 describes the available options for the *Active DUT*.

Table 23: Active DUTs

Option	Description
DUT1-16	Enables the specific DUT device placed on connector DUT1-DUT16.

DA1458x/DA1468x Production Line Tool

7.2.2.4 DUT COM Ports

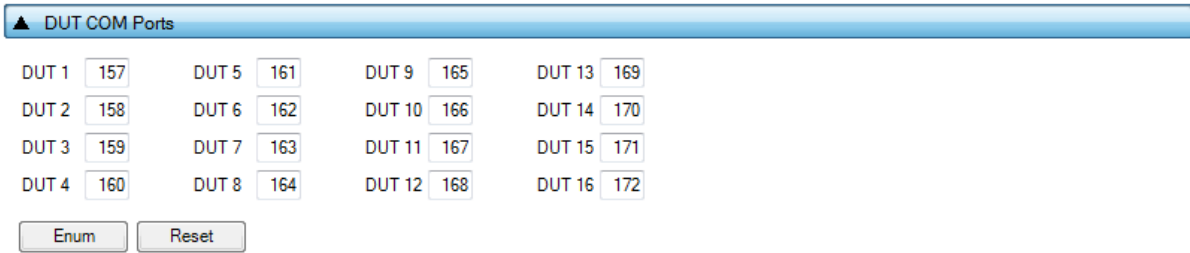

Figure 38: DUT COM Ports

This field shows the Windows COM port assigned to each DUT. The table is filled only when the 'COM Enum' action has been performed by the CFG or the GUI PLT applications, or when non-zero entries exist in the `com_port_x` `params.xml` options. When the 'COM Enum' action is performed, the tools will automatically find the DUT COM ports and save them in the `params.xml` file. These values will be read by the CFG PLT application and be displayed here. When a 'COM Enum' action has not been performed, the GUI PLT will automatically run it once in every first test execution.

**Note:** Great care must be taken when the `params.xml` file is shared across different stations, where different DUT COM Ports will probably exist. The 'COM Enum' action should then be performed again, so the new COM ports of the new PC system are identified and updated in the XML file.

Table 24 describes the available options for the *DUT COM Ports*.

Table 24: DUT COM Ports

Option	Description
DUT1-16	Shows the Windows COM port assigned to a specific DUT.
Reset	Sets all values to zero.
Enum	Executes the COM port enumeration procedure. The found COM ports are shown before being saved.

7.2.2.5 Golden Unit Port Selection



Figure 39: Golden Unit COM Port

This field holds the Golden Unit COM port. Manual or automatic COM port find can be selected.

The Golden Unit COM port can be manually selected from the list with all the available COM ports existing in the system. Additionally, it can automatically be found by pressing the **Auto** button. The automatic procedure searches the serial number of all system COM ports to find the "DialogSemi" string. Details on how to program the serial number in the GU FTDI can be found in [Appendix G](#).

Table 25: Golden Unit COM Port

Option	Description
Auto	Initiates the automatic Golden Unit COM port find procedure.
Refresh	Refreshes the Dropdown menu with all the available system COM ports.
Dropdown Menu	Manually select the Golden Unit COM port from all of the available system COM ports.

### DA1458x/DA1468x Production Line Tool

#### 7.2.2.6 VBAT/Reset Mode

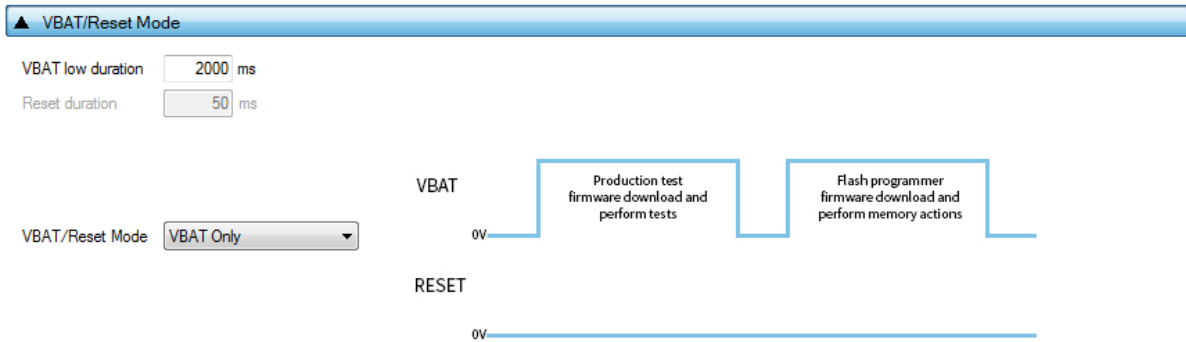

**Figure 40: VBAT/Reset Mode Selection**

This field holds the VBAT/Reset mode selections. This option sets the PLT VBAT and PLT Reset line modes for the DUT power supply and reset during the PLT test sequence. [Table 26](#) describes the available selections.

**Table 26: VBAT/Reset Mode**

Option	Description
VBAT/Reset Mode	Select the operation for VBAT/Reset signals. Available options are: <ul style="list-style-type: none"> <li>• VBAT Only</li> <li>• VBAT On with Reset</li> <li>• VBAT as Reset</li> <li>• VBAT and Reset</li> </ul> <a href="#">VBAT/Reset Signals Operation</a> chapter describes each mode in detail. Default setting is <i>VBAT only</i> .

#### 7.2.3 General

##### 7.2.3.1 Statistics

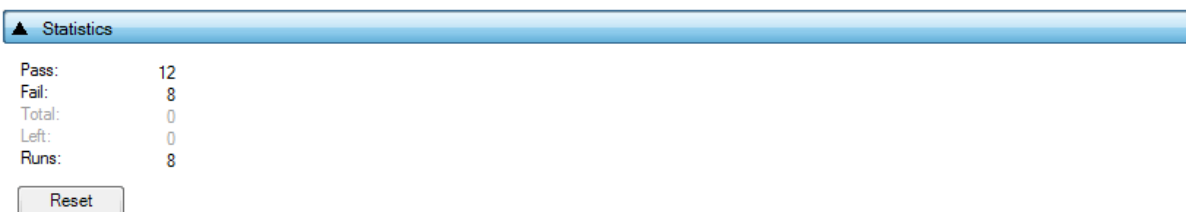

**Figure 41: Statistics**

This field holds the test result statistics. [Table 27](#) describes the *Statistics* field.

**Table 27: Statistics**

Option	Description
Pass	Shows the number of DUTs that have successfully passed all the tests.
Fail	Shows the number of DUTs that have failed the tests.
Total	Shows the number of DUTs that will be tested. This option is available only when <i>Range</i> mode is enabled in the <a href="#">BD Address Assignment</a> .
Left	Shows how many DUTs are still to be tested. This option is available only when <i>Range</i> mode is enabled in the <a href="#">BD Address Assignment</a> .

DA1458x/DA1468x Production Line Tool

Option	Description
Runs	Shows the number of test runs the PLT has performed.
Reset	Pressing the <b>Reset</b> button clears all statistics values to their defaults. Values <i>Pass</i> , <i>Fail</i> and <i>Runs</i> will be set to zero. If <i>Range</i> mode is enabled in the <a href="#">BD Address Assignment</a> , the <i>Total</i> and <i>Left</i> values will be set as the difference of <i>Next</i> and <i>End BD address</i> , otherwise will be set to zero.

7.2.3.2 Test Options

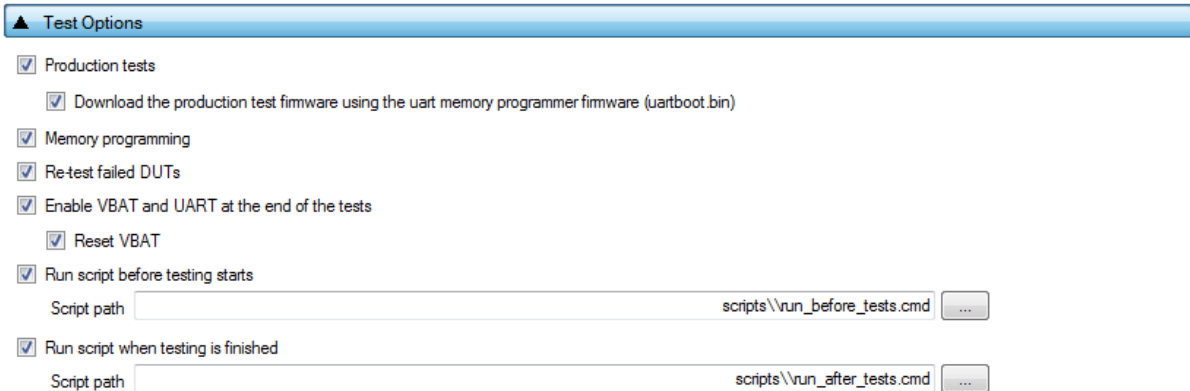

Figure 42: Test Options

This field holds generic PLT test procedure options. The PLT procedure is split into two main parts: *Production tests* and *Memory programming*.

*Production tests* include all the tests under [Test Settings \(DA1458x\)](#) or [Test Settings \(DA1468x\)](#). *Memory Programming* includes all the tests under [Memory Functions \(DA1458x\)](#) or [Memory Functions \(DA1468x\)](#) and [Memory Header \(DA1458x\)](#) or [Memory Header \(DA1468x\)](#).

[Table 28](#) describes the available settings for the *Test Options*.

Table 28: Test Options

Option	Description
Production tests	This option enables the production test operations.
Download the production test firmware using the UART memory programmer firmware (uartboot.bin). (Only for DA14681/2/3 Devices)	This option enables downloading the production test firmware using the memory programming firmware. PLT will first reset the DUTs and download the memory programming firmware (uartboot.bin), then it will send the production test firmware to the DUTs and by using a special command it will replace the firmware and the DUTs will automatically reset to the new firmware.
Memory programming	This option enables the memory programming operations.
Re-test failed DUTs	When this option is enabled, any DUT that failed will immediately be retested with the exact same options, including the <i>BD address</i> assigned to it. This option is the same as option <i>Retest failed DUTs - Enable</i> under <a href="#">GUI PLT Settings</a> .
Enable VBAT and UART at the end of the tests	Enables the VBAT lines and UART communication between the PC and the devices after all tests have finished, in order sustaining communication with the DUTs, optionally with the latest downloaded firmware.
Reset VBAT	If this option is enabled the VBAT line will be toggled. If not selected, the DUTs will keep in RAM the last test firmware downloaded by the PLT.

DA1458x/DA1468x Production Line Tool

Option	Description
Run script before testing starts	This option enables the execution of a batch or an executable before the device testing procedure starts. The success return code should be 0 for the tool not to report an error.
Script path	The path of file to execute when the <i>Run script before testing starts</i> option is enabled.
Run script when testing is finished	This option enables the execution of a batch or an executable after the device testing procedure has finished. The success return code should be 0 for the tool not to report an error.
Script path	The path of file to execute when the <i>Run script when testing is finished</i> option is enabled.

7.2.4 BD Addresses

7.2.4.1 BD Address Assignment

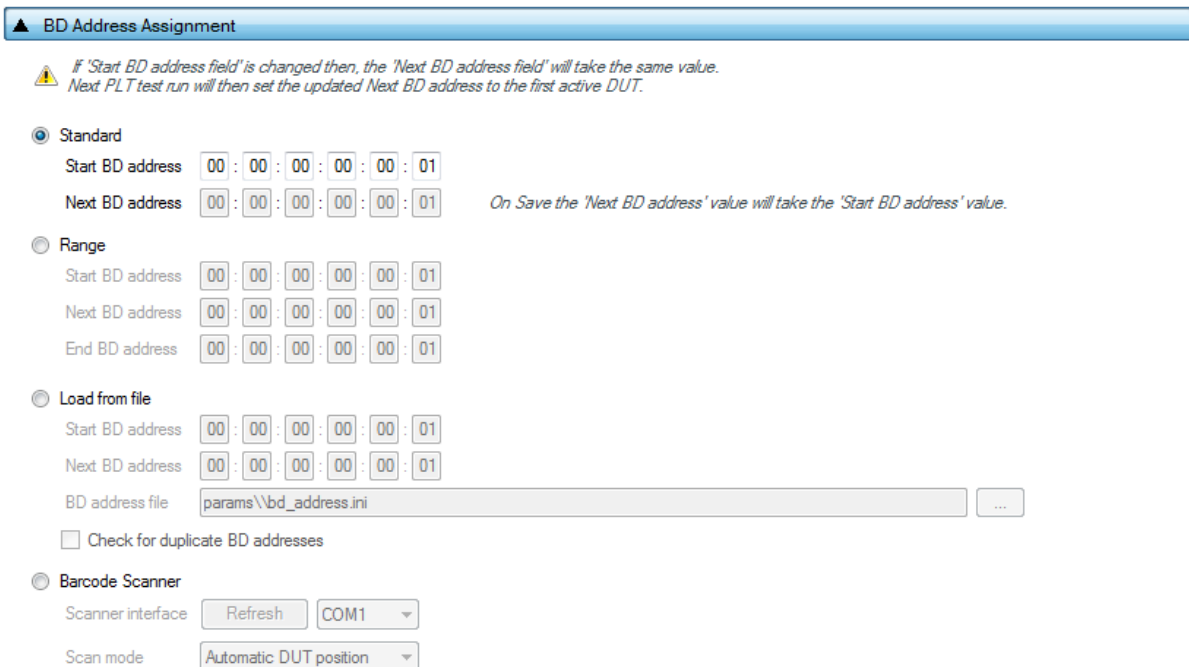

Figure 43: BD Address Assignment

The *BD Address Assignment* field defines different ways the PLT can handle the device BD address. The available modes are *Standard*, *Range*, *Load from file* and *Scan mode*.

The *Standard*, *Range*, and *Load from file* modes are similar. All of these have a *Start BD address*, which is the initial address at which the PLT session begins. The *Next BD address* field holds the BD address that will be used on the next PLT run, so the BD address assignment can be continued even after the GUI PLT is closed. For that reason, the *Next BD address* cannot be altered by the user. The *Next BD address* initial value is the same as the *Start BD address* when the PLT session begins.

For *Scan mode* an external barcode scanner is needed to assign the device BD addresses.

**Note:** In CFG PLT only the Start BD address is given. The assignment of the actual device BD addresses occurs in the GUI PLT at the beginning of each test run.

**Note:** The only **invalid** BD address is 00:00:00:00:00:00.

DA1458x/DA1468x Production Line Tool

Standard Mode

Table 29 describes the available options for the *Standard* mode. In this mode the first active DUT takes the *Next BD address*. This BD address is incremented by one and assigned to the next active DUT until all active DUTs have a BD address assigned to them.

This assignment mode never runs out of BD addresses and it will continue assigning addresses until the *Next BD address* reaches FF:FF:FF:FF:FF:FF.

Table 29: BD Address Assignment - Standard Mode

Option	Description
Start BD address	The BD address that the PLT session has started with.
Next BD address	The BD address that will be used in the first active DUT of the next PLT run.

Range Mode

Table 30 describes the available options for the *Range* mode. This mode is the same as *Standard* mode except for the additional *End BD address*.

Since both a Start BD and an End BD address exists, the total amount of devices to be tested can be calculated. Therefore, this mode enables the *Total* and *Left* fields in the *Statistics*, where *Total* is the number of the BD addresses to be used from *Start BD address* to *End BD address* and *Left* is the number of BD addresses remaining, which are the ones from *Next BD address* to *End BD address*.

**Note:** The *End BD address* must always be greater than the *Start BD address*. Also, when *Left* BD addresses are not enough for the remaining active DUTs, the PLT will not run.

Table 30: BD Address Assignment Options - Range Mode

Option	Description
Start BD address	The BD address that the PLT session has started with.
Next BD address	The BD address that will be used in the first active DUT of the next PLT run.
End BD address	The BD address that the PLT session will end with.

Load from File Mode

Table 31 describes the available options for the *Load from file* mode. In this mode, the *Start BD address* and the *Next BD address* have the same roles as before. The difference in this mode is that the BD addresses are loaded from a file in the order as they are written in that file, not using the automatic incremental method of the previous modes. In every test run the PLT will search for the first occurrence of the *Next BD address* in the file and will load it along with the BD addresses that follow, until all active DUTs have a BD address.

```

1  00:00:00:44:33:0a
2  00:00:00:44:33:09
3  00:00:00:44:33:08
4  00:00:00:11:22:08
5  00:00:00:11:22:06
6  00:00:00:11:22:05
7  00:00:00:11:22:04
8  00:00:00:11:22:03
9  00:00:00:11:22:02

```

Figure 44: Example for Load from File Mode

For example, consider three active DUTs: DUT3, DUT6, and DUT 9 and the *Next BD address* to be 00:00:00:11:22:08. Figure 44 shows the beginning of the BD address file used in this example. The PLT will search for the *Next BD address* in the file and load it to the first active DUT: DUT3. It will



DA1458x/DA1468x Production Line Tool

then continue with 00:00:00:11:22:06 for DUT6 and 00:00:00:11:22:05 for DUT9. It will also return 00:00:00:11:22:04 as the *Next BD address* to be used in the next PLT test run.

**Note:** The BD address file should always end with a zero BD address (00:00:00:00:00:00) and a new line at the end.

**Table 31: BD Address Assignment Options - Load from File Mode**

Option	Description
Start BD address	The BD address that the PLT session has started with.
Next BD address	The BD address from file that will be used in the first active DUT of the next PLT run.
BD address file	Path to the file that contains the BD addresses. Use button [...] on the right to navigate and select a file.
Check for duplicate BD addresses	Before any BD address is assignment happens, there will be a check to find double BD addresses in the selected BD address file.

Scan Mode

Table 32 describes the available options for the *Scan* mode. For this option a USB-to-Serial barcode scanner should be used to scan for BD address barcodes with "xx:xx:xx:xx:xx:xx" format.

The Barcode scanner options are the same as those used for the barcode scanner mode in [Custom Memory Data](#) for the DA1458x devices and in [Custom Memory Data](#) for the DA1468x devices.

**Table 32: BD Address Assignment Options - Scan Mode**

Option	Description
Scanner Interface	Selection of the barcode scanner COM port from a dropdown list with all the available system COM ports.  A common USB to UART barcode scanner is supported. PLT has been tested with Honeywell Xenon 1900. <a href="#">Appendix K</a> describes the setup procedure.  <b>This option is the exact same option as for the DA1458x devices in <a href="#">Custom Memory Data</a> and the DA1468x devices in <a href="#">Custom Memory Data</a>.</b>
Scan mode	<b>Scan DUT position:</b> In this mode the users must first scan the DUT position number and then the BD address. The string used for the position of each DUT is "TEST POSITION 0xx" where "xx" is the DUT position number.  <b>Automatic DUT position:</b> Scanned BD address will be assigned to the selected DUT. The DUT selection is automatically been made, starting from the first active DUT and selecting the next one after a successful BD address scan. Users can change the selected DUT using the controls on the GUI PLT screen shown in <a href="#">Figure 102</a> .  <b>This option is the exact same option as for the DA1458x devices in <a href="#">Custom Memory Data</a> and the DA1468x devices in <a href="#">Custom Memory Data</a>.</b>

7.2.5 UART (DA1458x)

7.2.5.1 UART Boot Pins Setup



**Figure 45: UART Boot Pins Setup - DA1458x**

Table 33 describes the available options for the *TX-RX pins* of the *UART Boot Pins Setup* DA1458x options. *The TX-RX pins* selection defines the UART pins and the baud rate that will be used for firmware downloading to the DA1458x during booting.

### DA1458x/DA1468x Production Line Tool

**Table 33: UART TX-RX Pins - DA1458x**

Option	Description
TX: P0_0, RX: P0_1	Sets UART TX pin to P0_0, UART RX pin to P0_1 and Baud rate to 57600 bit/s.
TX: P0_2, RX: P0_3	Sets UART TX pin to P0_2, UART RX pin to P0_3 and Baud rate to 115200 bit/s.
TX: P0_4, RX: P0_5	Sets UART TX pin to P0_4, UART RX pin to P0_5 and Baud rate to 57600 bit/s.
TX: P0_6, RX: P0_7	Sets UART TX pin to P0_6, UART RX pin to P0_7 and Baud rate to 9600 bit/s.

**Note:** The baud rate is fixed during booting, since it is controlled by the device ROM bootloader.

#### 7.2.5.2 UART Baud Rate

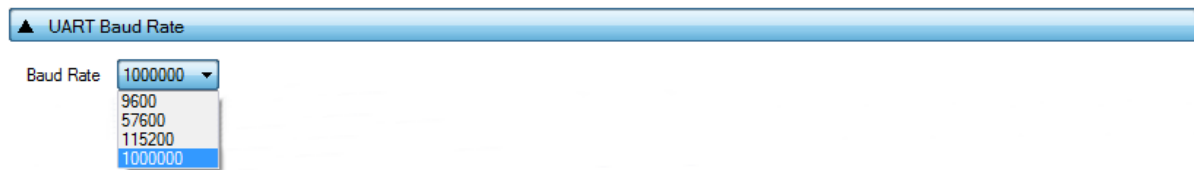

**Figure 46: UART Baud Rate - DA1458x**

Table 34 shows the available options for the *UART baud rate*.

The *Baud Rate* selected here is used after the initial firmware (*flash\_programmer.bin*) has been downloaded to the DUT. The software will send a command to the DUT to change the UART baud rate to the one selected. All following UART communications with the DUT will be performed using the new baud rate. Please note that this happening only during memory programming where the *flash\_programmer.bin* is used. During tests (RF tests, XTAL trimming, etc.), where the production test firmware is used, the baud rate is fixed at 115200 bit/s.

**Table 34: UART Baud Rate - DA1458x**

Option	Description
Baud Rate	<ul style="list-style-type: none"> <li>9600 [bit/s]</li> <li>57600 [bit/s]</li> <li>115200 [bit/s]</li> <li>1000000 [bit/s]</li> </ul> <p><b>Note:</b> 1 Mbit/s is the fastest and safest with 0% baud rate error.</p>

#### 7.2.5.3 UART Programming GPIOs Setup

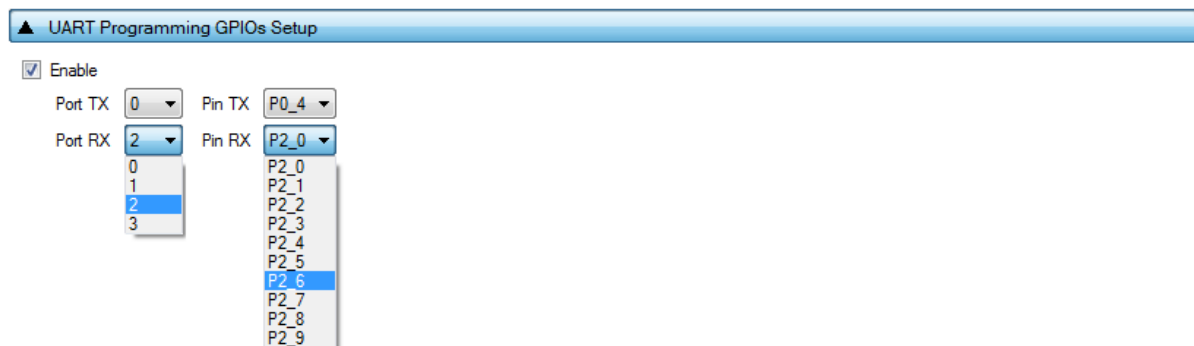

**Figure 47: UART Programming GPIOs Setup - DA1458x**

Table 35 shows the available options for the *UART Programming GPIOs* to be used during memory programming for the DA1458x devices.

DA1458x/DA1468x Production Line Tool

**Note:** This option should be **disabled** if the *UART Programming GPIOs* are exactly the same as the *UART Boot Pins* selected in [UART Boot Pins Setup](#).

When this option is enabled, the user can configure a new set of UART pins to be used during tests and memory programming. The purpose of changing pins is to be able to use different UART pins than the predefined pairs supported by the DUT ROM bootloader, in case these default pins are used for other external components.

The DUT will always boot from a predefined pair of pins as configured in the *UART Boot Pins Setup*. Then it will switch to the new pins configured here by sending a command to the firmware, for both the *Production tests* and the *Memory programming* firmware. A separate UART hardware connection has to be made between the PLT hardware board and the DUT.

The DUT will have four UART connections with the PLT hardware. The connections should be made using enhanced PLT DUT connectors. For a single DUT, the UART boot pins should be connected to the PLT DUT connector 1 (DUT1) and the UART Programming GPIOs should be connected to the PLT DUT connector 2 (DUT2). In this configuration the PLT can support up to eight DUTs.

**Table 35: UART Programming GPIOs Setup - DA1458x**

Option	Description
Enable	This option enables the UART programming mode. Users can select the new UART TX-RX GPIOs from the dropdown lists.
Port TX	Dropdown list to select the port of the UART TX GPIO that will be used during testing. This option alters the contents of the <i>Pin TX</i> dropdown list to the available GPIOs based on the selected port.
Pin TX	Dropdown list to select the UART TX GPIO that will be used during testing.
Port RX	Dropdown list to select the port of the UART RX GPIO that will be used during testing. This option alters the contents of the <i>Pin RX</i> dropdown list to the available GPIOs based on the selected port.
Pin RX	Dropdown list to select the UART RX GPIO that will be used during testing.

7.2.6 Test Settings (DA1458x)

7.2.6.1 XTAL Trim

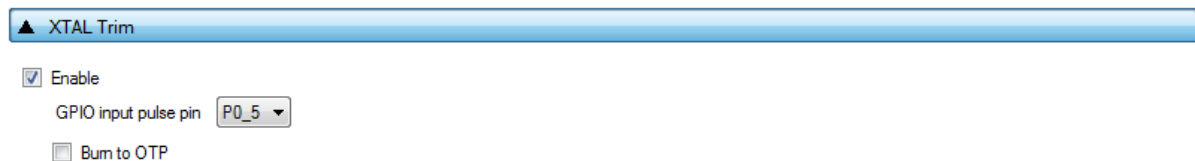

**Figure 48: XTAL Trim - DA1458x**

[Table 36](#) describes the available options for the DA1458x *XTAL Trim* operation.

**Table 36: XTAL Trim - DA1458x**

Option	Description
Enable	This option enables the automatic crystal oscillator frequency calibration procedure.
GPIO input pulse pin	The GPIO on which the DUT will receive the reference pulse during calibration. The UART RX pin can be used for this purpose without any additional connection from the PLT hardware to the DUT.
Burn to OTP	When this option is selected, the XTAL trim value calculated from the automated calibration process will be written into the OTP XTAL trim header field and the OTP XTAL calibration flag will be set.

DA1458x/DA1468x Production Line Tool

7.2.6.2 RF Tests

This section refers to various RF tests conducted between the DUTs and the Golden Unit or an external BLE tester.

These tests can have multiple instances with different settings. Tests can be added and removed using the two buttons (e.g. and in Figure 49) at the bottom right side of each panel.

**Note:** When adding or removing a test, all settings are refreshed with the values written to the XML file, meaning that any unsaved settings will be lost.

Golden Unit

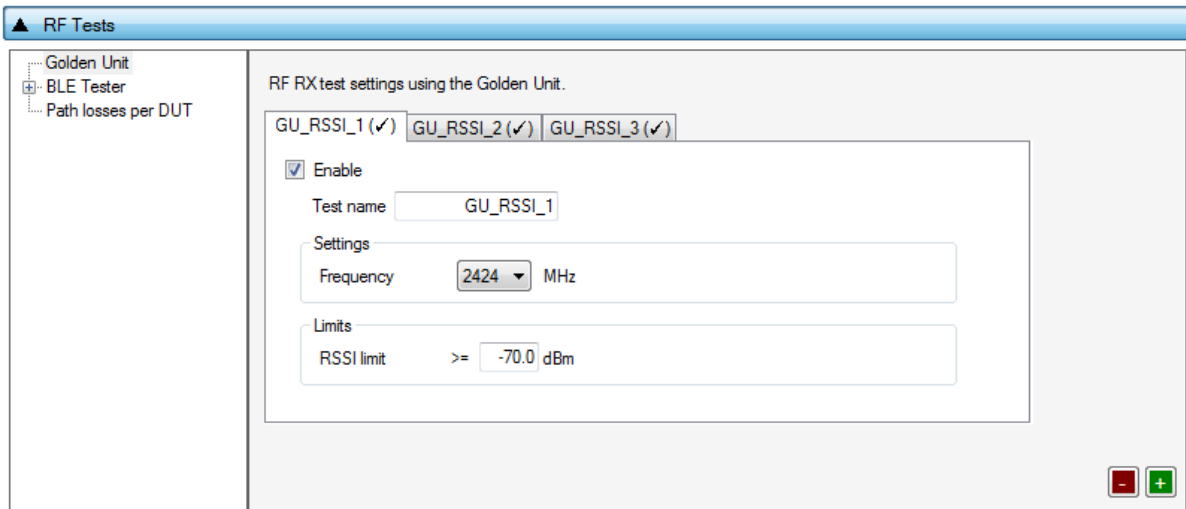

Figure 49: Golden Unit RF Tests - DA1458x

Table 37 describes the available options for the RF RX test using the Golden Unit as a transmitter.

In the RF RX test the Golden Unit sends 500 packets on the selected BLE channel. The DUTs are set in receive mode and the RSSI is measured. If the RSSI measured by the DUT reception is less than the specified RSSI limit value, the device will fail and the tests will stop for that particular device.

Table 37: Golden Unit RF Tests - DA1458x

Option	Description
Enable	This option enables the specific RF RX test using the Golden Unit as a transmitter.
Test name	The name assigned to each test. If this field is non-empty, then the assigned name will be shown on the tab and next to it an indication showing whether the specific test is enabled or not.
Frequency	The BLE channel frequency used in the RF RX test using the Golden Unit.
RSSI limit	The RSSI limit for pass/fail criteria in the RF RX test using the Golden Unit. If the average RSSI of the device after it has received the packets transmitted from the Golden Unit is less than that the test will be considered as failed.

BLE Tester

In the BLE Tester panels a number of tests can be enabled that require an external BLE tester instrument. More detailed information about the BLE tester can be found in [1].

DA1458x/DA1468x Production Line Tool

BLE Tester – General Settings

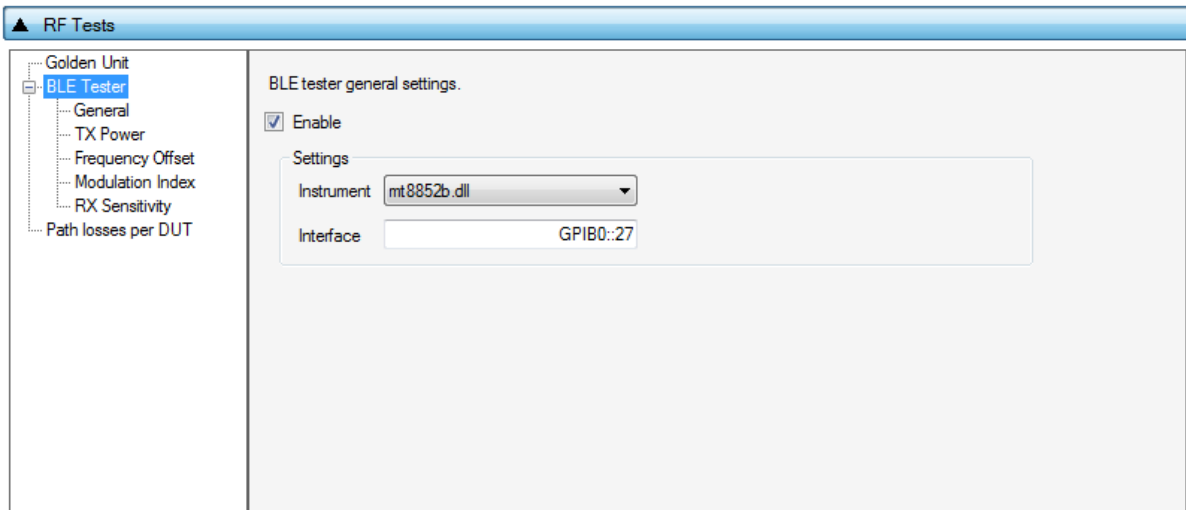

Figure 50: BLE Tester General Settings - DA1458x

Table 38 describes the general settings for the *BLE Tester* supported tests. Any available external instrument found by the `ble_tester_driver` DLL and their interfaces can be selected.

Table 38: BLE Tester General Settings - DA1458x

Option	Description
Enable	This option enables all of the <i>BLE Tester</i> tests, which include: <ul style="list-style-type: none"> <li>• BLE Tester TX Power</li> <li>• Frequency Offset</li> <li>• Modulation Index</li> <li>• RX Sensitivity</li> </ul>
Instrument	Select the BLE tester DLL name. Names are shown only if a BLE tester instrument DLL exists in the project <code>ble_tester_instr_plugins</code> folder.
Interface	The interface of the instrument to be used by the driver.

BLE Tester - TX Power

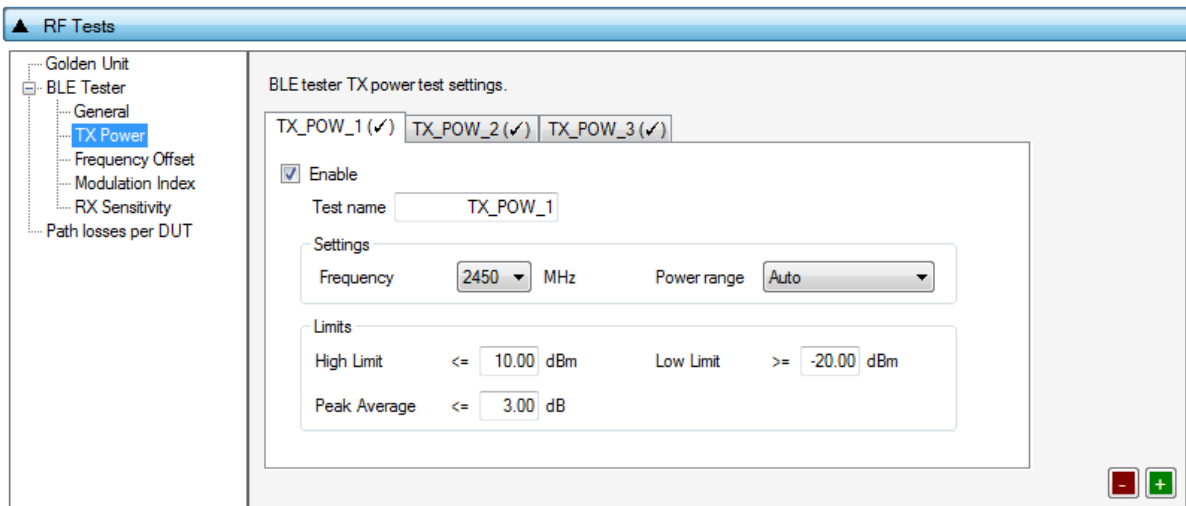

Figure 51: BLE Tester TX Power - DA1458x

DA1458x/DA1468x Production Line Tool

Table 39 describes the available options for the TX Power test using a BLE Tester instrument.

Table 39: BLE Tester TX Power - DA1458x

Option	Description
Enable	This option enables the specific TX power test using a BLE tester instrument.
Test name	The name assigned to each test. If this field is non-empty, then the assigned name will be shown on the tab and next to it an indication showing whether the specific test is enabled or not.
Frequency	The BLE channel frequency used in the BLE TX power test.
Power range	Set the device TX output power range. Available options are: <ul style="list-style-type: none"> <li>• Auto (No auto option for Litepoint IQxelM. Sets the instrument to trigger at -25dBm)</li> <li>• +22 dBm to +7 dBm</li> <li>• +9 dBm to -3 dBm</li> <li>• +5 dBm to -7 dBm</li> <li>• -4 dBm to -16 dBm</li> <li>• -12 dBm to -26 dBm</li> <li>• -24 dBm to -35 dBm</li> </ul> Default value is <i>Auto</i> .
High limit	Set the average high power limit for the BLE TX output power pass/fail test criteria.
Low limit	Set the average low power limit for the BLE TX output power pass/fail test criteria.
Peak average	Set the peak-to-average power limit for the BLE TX output power pass/fail test criteria.

BLE Tester - Frequency Offset

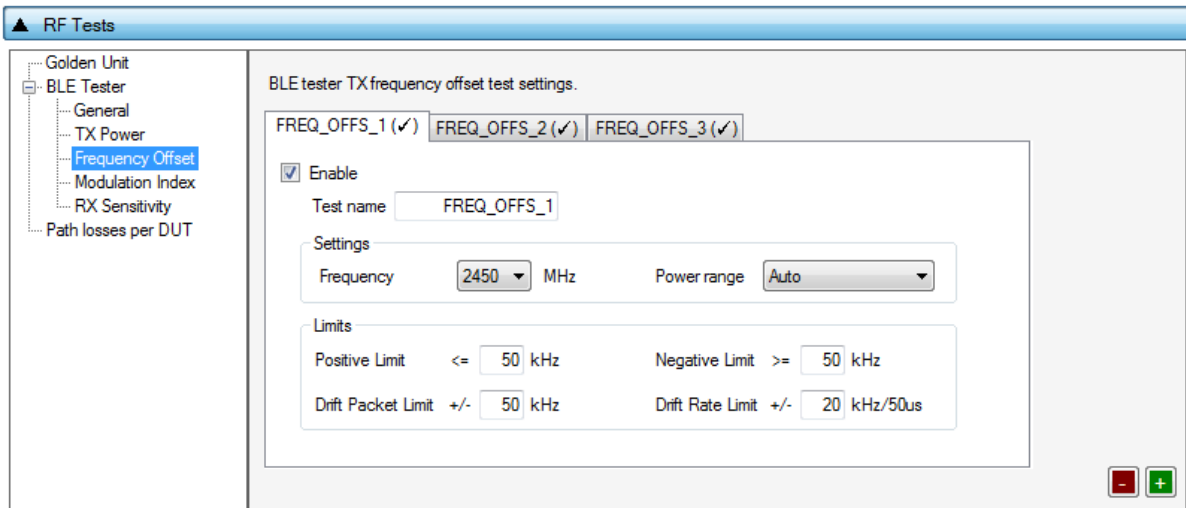

Figure 52: BLE Tester Frequency Offset - DA1458x

Table 40 describes the available options for the Frequency Offset test using a BLE Tester instrument.

Table 40: BLE Tester Frequency Offset - DA1458x

Option	Description
Enable	This option enables the specific TX frequency offset test using a BLE tester instrument.
Test name	The name assigned to each test. If this field is non-empty, then the assigned name will be shown on the tab and next to it an indication showing whether the specific test is enabled or not.

DA1458x/DA1468x Production Line Tool

Option	Description
Frequency	The BLE channel frequency used in the BLE TX frequency offset test.
Power range	Set the device TX output power range. Available options are: <ul style="list-style-type: none"> <li>• Auto</li> <li>• +22 dBm to +7 dBm</li> <li>• +9 dBm to -3 dBm</li> <li>• +5 dBm to -7 dBm</li> <li>• -4 dBm to -16 dBm</li> <li>• -12 dBm to -26 dBm</li> <li>• -24 dBm to -35 dBm</li> </ul> Default value is <i>Auto</i> .
Positive limit	Set the maximum positive offset limit in kHz for the TX carrier frequency offset pass/fail test criteria.
Negative limit	Set the maximum negative offset limit in kHz for the TX carrier frequency offset pass/fail test criteria.
Drift packet limit	Set the overall packet drift in kHz for the TX drift pass/fail test criteria.
Drift rate limit	Set the drift rate limit in kHz/50 $\mu$ s for the TX drift pass/fail test criteria.

BLE Tester - Modulation Index

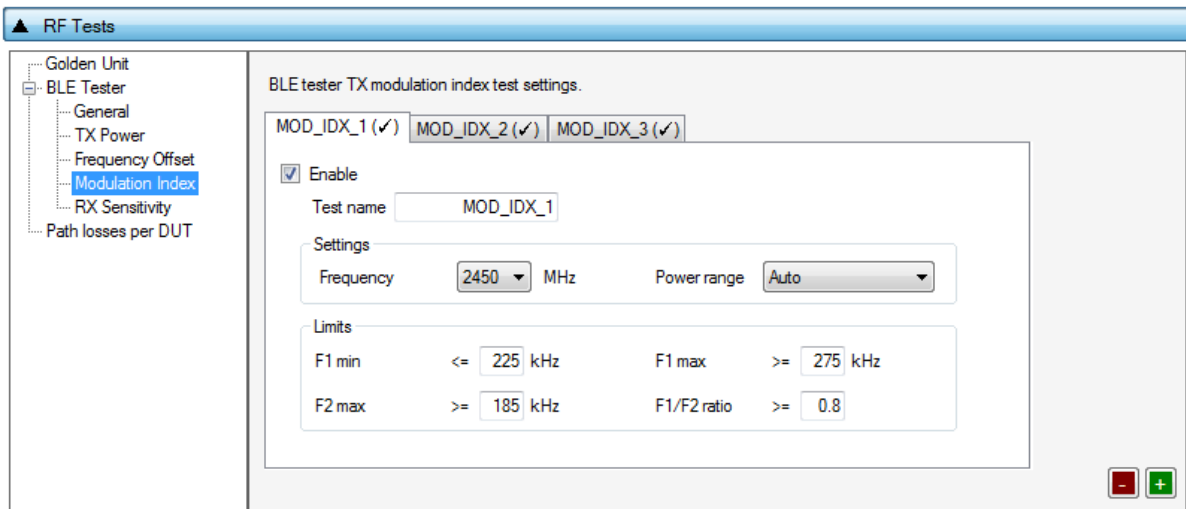

Figure 53: BLE Tester Modulation Index - DA1458x

Table 41 describes the available options for the *Modulation Index* test using a BLE Tester instrument.

Table 41: BLE Tester Modulation Index - DA1458x

Option	Description
Enable	This option enables the specific TX modulation index test using a BLE tester instrument.
Test name	The name assigned to each test. If this field is non-empty, then the assigned name will be shown on the tab and next to it an indication showing whether the specific test is enabled or not.
Frequency	The BLE channel frequency used in the BLE TX modulation index offset test.



DA1458x/DA1468x Production Line Tool

Option	Description
Power range	Set the device TX output power range. Available options are: <ul style="list-style-type: none"> <li>• Auto</li> <li>• +22 dBm to +7 dBm</li> <li>• +9 dBm to -3 dBm</li> <li>• +5 dBm to -7 dBm</li> <li>• -4 dBm to -16 dBm</li> <li>• -12 dBm to -26 dBm</li> <li>• -24 dBm to -35 dBm</li> </ul> Default value is <i>Auto</i> .
F1 min	Set the F1 minimum average limit in kHz for the TX modulation index pass/fail test criteria.
F1 max	Set the F1 maximum average limit in kHz for the TX modulation index pass/fail test criteria.
F2 max	Set the F2 maximum limit in kHz for the TX modulation index pass/fail test criteria.
F1/F2 ratio	Set the F1/F2 maximum average ratio limit for the TX modulation index pass/fail test criteria.

BLE Tester - RX Sensitivity

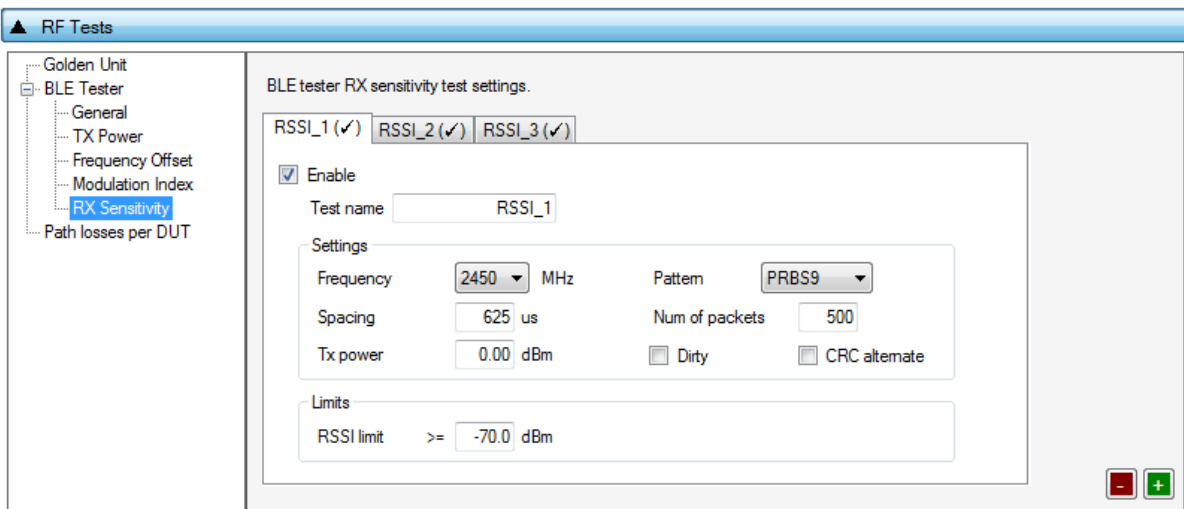

Figure 54: BLE Tester RX Sensitivity - DA1458x

Table 42 describes the available options for the *RX Sensitivity* test using a BLE Tester instrument.

Table 42: BLE Tester RX Sensitivity - DA1458x

Option	Description
Enable	This option enables the specific RX sensitivity test using a BLE tester instrument.
Test name	The name assigned to each test. If this field is non-empty, then the assigned name will be shown on the tab and next to it an indication showing whether the specific test is enabled or not.
Frequency	The BLE channel frequency used in the BLE RX sensitivity test.
Pattern	The bit pattern of the TX data. Available options are: <ul style="list-style-type: none"> <li>• PRBS9</li> <li>• 10101010</li> <li>• 11110000</li> </ul>

DA1458x/DA1468x Production Line Tool

Option	Description
Spacing	The packet spacing in $\mu$ s.
Num of packets	The number of packets the BLE tester instrument to transmit.
Tx power	The TX output power of the BLE tester instrument. Suggested values are 0 to -10 dBm.
Dirty	When enabled, the BLE tester packet generator can use a dirty table to transmit.
CRC alternate	When enabled, the BLE tester will alternately send packets with CRC correct and CRC incorrect.
RSSI limit	The RSSI limit for pass/fail criteria in the RF RX sensitivity test. If the average RSSI of the device after it has received the transmitted packets is less than this value, the test will be considered as failed.

Path Losses per DUT

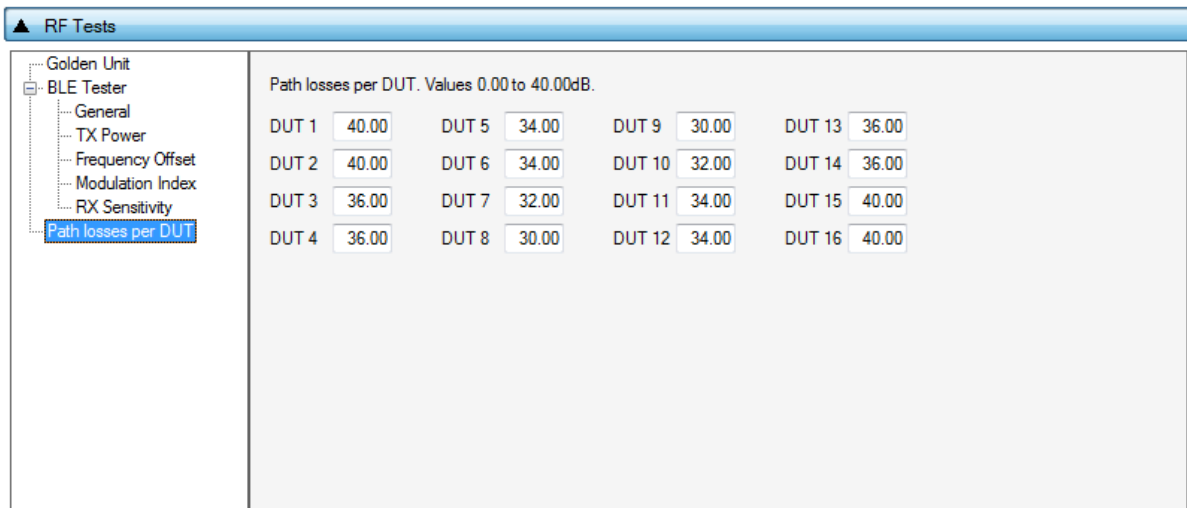

Figure 55: Path Losses per DUT - DA1458x

Table 43 describes the available options for the *Path losses per DUT*.

Based on the relative position of each DUT during the RF tests and since the RF tests are performed over the air, values can be used to correct for any path losses. These values are added to the limits of the TX Power and RF RX RSSI tests. Additional information can be found in 0.

Table 43: Path Losses per DUT from RF Tests DA1458x Options

Option	Description
DUT1-16	Set the calibrated path loss value for each DUT. These will be added as corrections to the limits of the TX Power and RF RX RSSI tests.

DA1458x/DA1468x Production Line Tool

7.2.6.3 Current Measurement Test

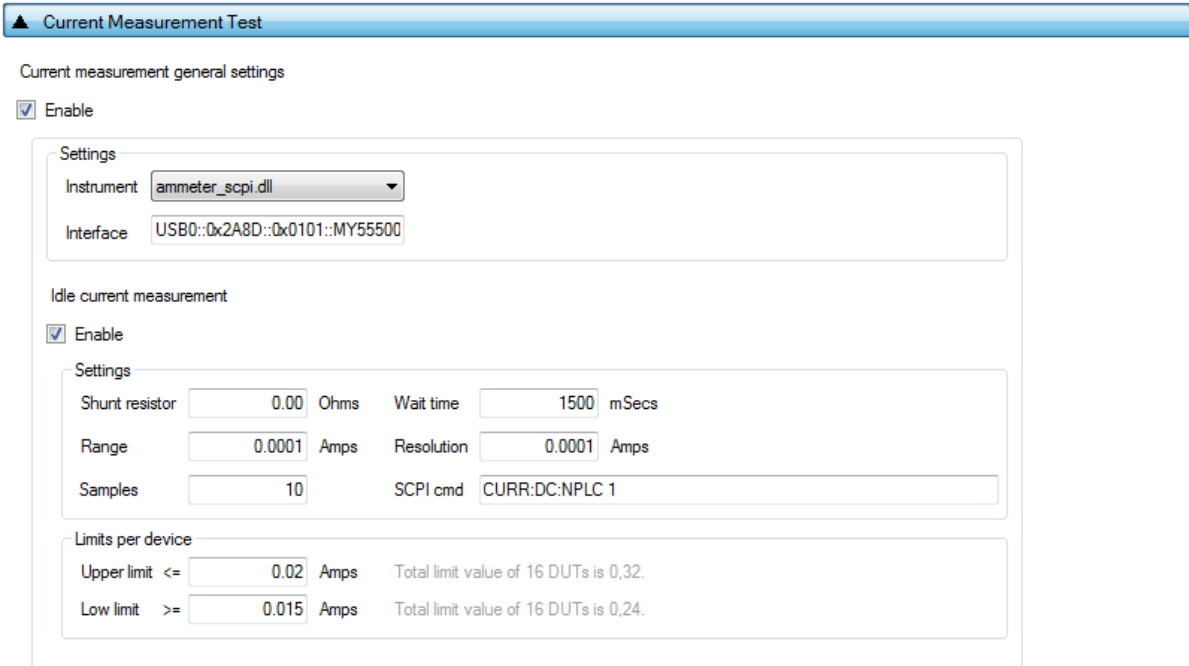

Figure 56: Current Measurement Tests - DA1458x

In this test an external ammeter instrument can be used to calculate the total current consumption of all the active DUTs at the time of the sampling. The ammeter instrument can be connected in the blue banana plugs as described in [Current Measurements](#) or to an external power supply (if present) depending the selected [VBAT/Reset Mode](#).

During measurement, PLT will control the instrument using the `ammeter_driver` DLL [1]. [Table 44](#) describes the instrument selection settings found by the `ammeter_driver` DLL and in [Table 45](#) the current measurement options for each sleep state.

**Note:** Modifications in the Production test firmware are mandatory in order to achieve the correct current consumption of a specific hardware design(IC and peripherals) for each sleep state. Running the default firmware without any modifications for the hardware design may cause increased current consumption.

Table 44: Current Measurement Tests - DA1458x

Option	Description
Enable	This option enables all of Current Measurement tests, which include: <ul style="list-style-type: none"> <li>Idle Current Measurement</li> <li>Extended Sleep Current Measurement</li> <li>Deep Sleep Current Measurement</li> </ul> Only one of the Extended/Deep sleep current measurements can be selected, meaning that the other one will be disabled.
Instrument	Select the Ammeter instrument DLL name. Names are shown only if an ammeter instrument DLL exists in the project <code>ammeter_instr_plugins</code> folder.
Interface	The interface of the instrument to be used by the driver.

DA1458x/DA1468x Production Line Tool

Table 45: Current Measurement for each Sleep State

Option	Description
Enable	This option enables the specific current measurement using the ammeter instrument provided in the <i>Instrument</i> section.
Shunt resistor	The value of the shunt resistor used for idle current measurement. Applicable only if a voltmeter or a NI-DAQ is used to measure current instead of a DMM. Values from 0 to 9999 are supported.
Wait time	The time in ms the PLT will wait before taking a current measurement, after it has sent an instruction to the DUTs to go into a specific sleep state. Supported values are 1 to 500000ms.
Sleep time (only for extended sleep)	The time in seconds that the DUTs will remain in extended sleep mode. A timer in the production test firmware will wake up the devices and set them to idle mode. Supported values are 1 to 9sec for DA14580/1/2/3 and up to 1200sec for the rest.
Range	The range value in Ampere units that the ammeter instrument will operate. Supported values are 0 to 9999 and default value is 0.001A.
Resolution	The ammeter instrument resolution value in Ampere units.
Samples	The number of samples that the ammeter instrument will read and average. 1 to 1000 is supported.
SCPI cmd	An SCPI command to be passed to the ammeter instrument just before the measurement is taken. Supports multiple commands separated with a column. Up to 256 characters are supported.
Upper limit	The upper limit value for the extended sleep current measurement test procedure, for a single DUT. Next to this input field the total upper limit current consumption for all the enabled DUTs is shown, which is the value to be used during testing. <b>Note:</b> During testing some DUTs may fail until the current measurement test takes place, in that case the PLT will automatically re-calculate the total upper limit by using the value given for a single DUT multiplied with the number of the active DUTs at the time that the test will run.
Low limit	The low limit value for the extended sleep current measurement test procedure, for a single DUT. Next to this input field the total upper limit current consumption for all the enabled DUTs is shown, which is the value to be used during testing. <b>Note:</b> During testing some DUTs may fail until the current measurement test takes place, in that case the PLT will automatically re-calculate the total low limit by using the value given for a single DUT multiplied with the number of the active DUTs at the time that the test will run.

7.2.6.4 GPIO/LED Test

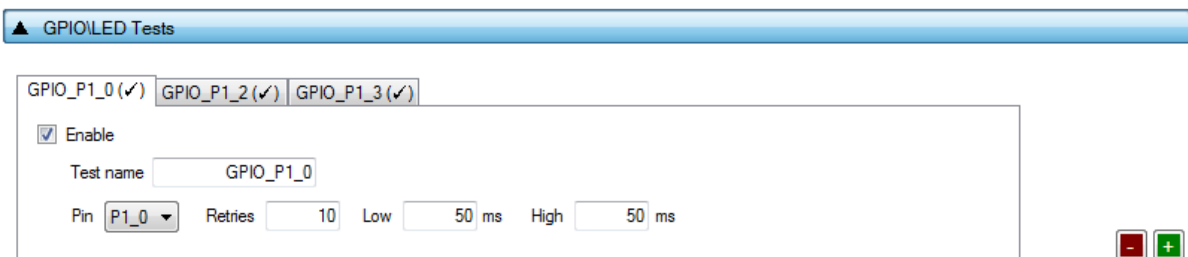

Figure 57: GPIO/LED Tests - DA1458x

GPIO/LED Tests can have multiple instances with different settings. Tests can be added or removed using the two buttons (e.g. and in Figure 57) at the bottom right side of each panel.

DA1458x/DA1468x Production Line Tool

**Note:** When adding or removing a test, all settings are refreshed with the values written to the XML file, meaning that any unsaved settings will be lost.

Table 46 describes the available options for the *GPIO/LED Tests* DA1458x Options.

In these tests a specific pulse can be given to a GPIO and any LED connected to it can be visually tested. The *Pin* option sets the GPIO to be used, *Low* and *High* define the duty cycle and the *Retries* the number of pulses.

**Table 46: GPIO/LED Tests - DA1458x**

Option	Description
Enable	This option enables the GPIO/LED toggling. Can be used for visual LED testing.
Test name	The name assigned to each test. If this field is non-empty, then the assigned name will be shown on the tab and next to it an indication showing whether the specific test is enabled or not.
Pin	The GPIO that will be used for the specific test.
Retries	Number of pulses to be generated for the specific test.
Low	Sets the amount of the OFF time of the pulse in ms for the specific test.
High	Sets the amount of the ON time of the pulse in ms for the specific test.

7.2.6.5 Audio Test

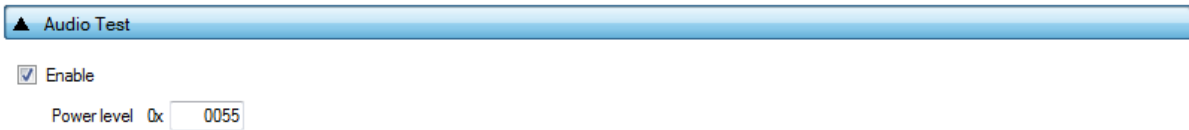

**Figure 58: Audio Test**

Table 47 describes the available options for the *Audio Test Trim* DA1458x Options.

Enabling this test will set the DUTs to listen for a 4 kHz tone produced by the Golden Unit. The DUT will send the audio data received to the PLT software. The PLT software will decode them, analyze if a 4 kHz tone exists in the audio data, and calculate the *Power Level*. If the tone is not detected or if the power level calculated is less than the one entered here the test will fail.

In order to perform the audio test the Golden Unit can generate a 4 kHz tone using an external speaker connected as shown in [Appendix M](#).

**Note:** Audio test is supported only for DA14582, DA14585 and DA14586 devices.

**Table 47: Audio Test**

Option	Description
Enable	This option enables the Audio testing.
Power level	The threshold limit of the power level calculated for the 4 kHz tone.

7.2.6.6 Sensor Test

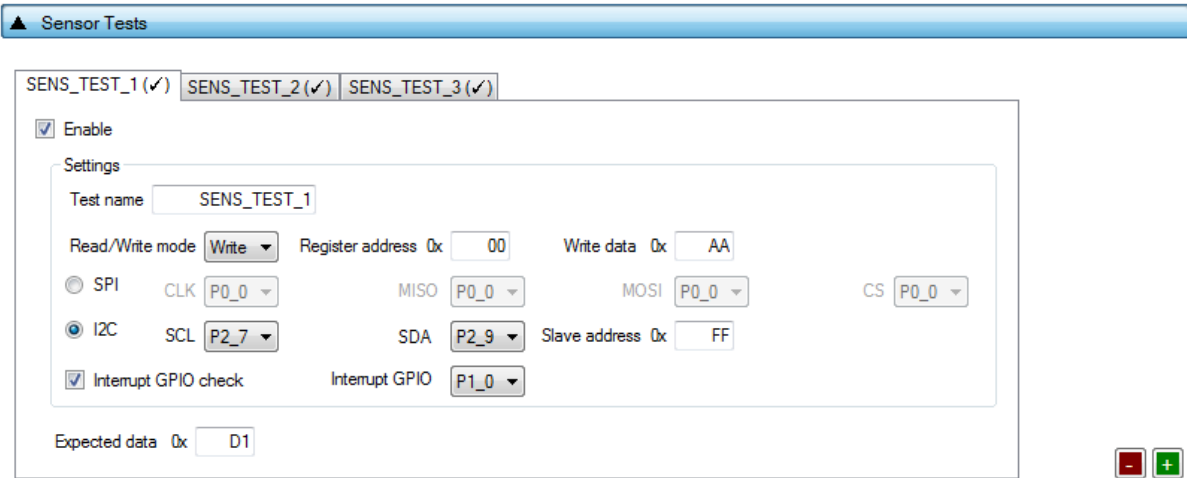



Figure 59: Sensor Test - DA1458x

Sensor Tests can have multiple instances with different settings. Tests can be added and removed using the two buttons (e.g.  and  in Figure 59) at the bottom right side of each panel.

**Note:** When adding or removing a test all settings are refreshed with the values written to the XML file, meaning that any unsaved settings will be lost.

Table 48 describes the available options for the Sensor Tests DA1458x Options.

Table 48: Sensor Tests - DA1458x

Option	Description
Enable	This option enables the specific sensor test.
Test name	The name assigned to each test. If this field is non-empty, then the assigned name will be shown on the tab and next to it an indication showing whether the specific test is enabled or not.
Read / Write mode	Select the sensor test procedure, to read or write.
Register address	The sensors register address to read or write data.
Write data	The byte to be written at the sensor register.
SPI / I2C	Select the interface that the sensor is connected to.
SPI - CLK	Select the GPIO for the sensor SPI CLK.
SPI - MISO	Select the GPIO for the sensor SPI MISO.
SPI - MOSI	Select the GPIO for the sensor SPI MOSI.
SPI - CS	Select the GPIO for the sensor SPI CS.
I2C - SCL	Select the GPIO for the sensor I2C SCL.
I2C - SDA	Select the GPIO for the sensor I2C SDA.
Slave address	The sensor I2C bus slave address.
Interrupt GPIO check	Enables the sensor interrupt signal test via GPIO.
Interrupt GPIO	Select the GPIO to be used as a sensor interrupt.
Expected data	The received sensor byte that will be expected on a successful operation.

DA1458x/DA1468x Production Line Tool

7.2.6.7 Custom Test

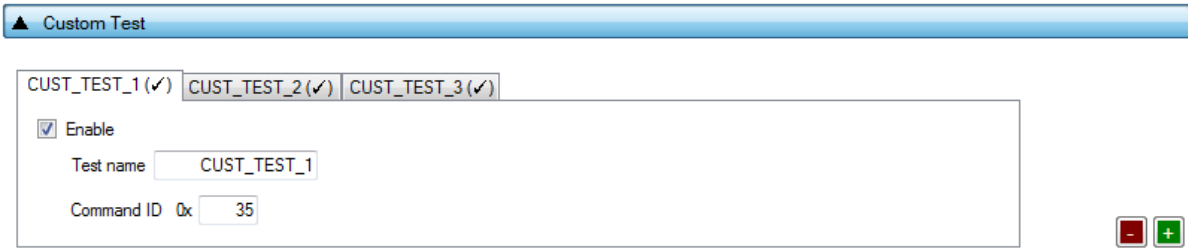



Figure 60: Custom Test - DA1458x

Custom Tests can have multiple instances with different settings. Tests can be added and removed using the two buttons (e.g.  and  in Figure 60) at the bottom right side of each panel.

**Note:** When adding or removing a test all settings are refreshed with the values written to the XML file, meaning that any unsaved settings will be lost.

Table 49 describes the available options for the DA1458x Custom Tests.

When enabled, the PLT software will send an HCI command via the UART to activate a customer defined test that will run on the DUTs. The HCI custom test command will contain a single byte as data (the Command ID byte), to be used mainly as identification for a specific test in the customized firmware. Default functionality of the production test firmware is to respond with the same Command ID. Otherwise PLT will be considered the test as failed.

Table 49: Custom Tests - DA1458x

Option	Description
Enable	This option enables the specific custom test.
Test name	The name assigned to each test. If this field is non-empty, then the assigned name will be shown on the tab and next to it an indication showing whether the specific test is enabled or not.
Command ID	The byte that will be sent to the device running the production test firmware.

7.2.6.8 Temperature Measurement Test

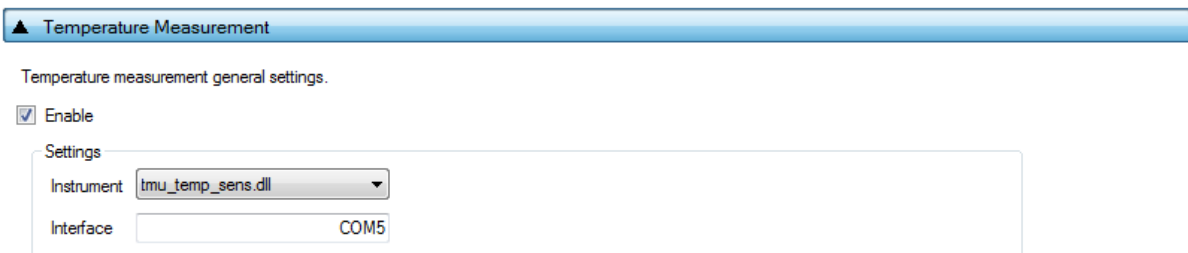

Figure 61: Temperature Measurement Test - DA1458x

Table 50 describes the available options of the DA1458x Temperature Measurement Test.

Table 50: Temperature Measurement Test - DA1458x

Option	Description
Enable	This option enables the temperature measurement test.



DA1458x/DA1468x Production Line Tool

Option	Description
Instrument	Selects the temperature measurement DLL. Names are shown only if a temperature measurement instrument DLL exists in the project folder <code>temp_meas_instr_plugins</code> .
Interface	The interface of the instrument to be used by the driver.

7.2.6.9 Scan Test

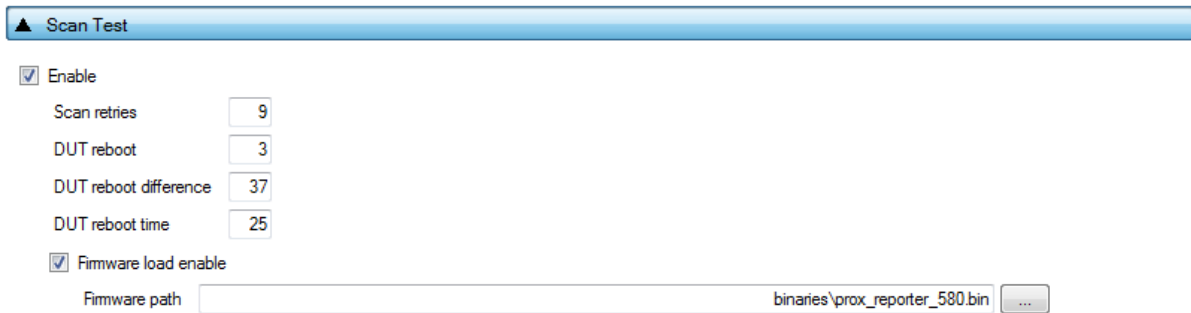

Figure 62: Scan Test - DA1458x

Table 51 describes the available options for the DA1458x *Scan Test*.

By enabling this test, the Golden Unit will scan for the DUT’s BD addresses advertised after the customer firmware has been burned. For this test to work, a bootable firmware with the ability to advertise with the BD address given by the PLT, must be burned into each DUT. Additionally, the BD addresses provided by the PLT should be burned into OTP memory, such that the devices advertise with the BD addresses that the tool uses.

Table 51: Scan Test DA1458x Options

Option	Description
Enable	This option enables the Scan test.
Scan retries	The total number of BLE advertising scans the Golden Unit will perform.
DUT reboot	Define after how many retries the PLT will reboot the DUTs.
DUT reboot difference	Set the time difference between each DUT when the PLT reboots the devices, in order to avoid air collisions.
DUT reboot time	The time the VBAT will remain low during the device reboot. This value is time in ms*100. (e.g. 15 is 1500ms).
Firmware load enable	By enabling this option a new image will be downloaded to all active DUTs before scanning for BLE advertising devices.
Firmware path	The path of the binary file to download to the devices for the scan test.

DA1458x/DA1468x Production Line Tool

7.2.7 Memory Functions (DA1458x)

This section describes the Memory Functions settings available when using DA1458x devices. Memory functions include OTP, SPI Flash, and I2C EEPROM memory programming.

7.2.7.1 OTP Memory

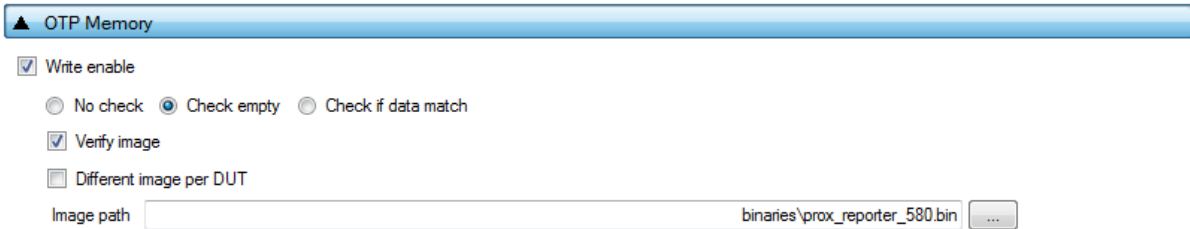

Figure 63: OTP Memory - DA1458x

This test enables the OTP memory programming. Table 52 describes the available options for the *OTP Memory* image write operation.

Table 52: OTP Memory - DA1458x

Option	Description
Write enable	This option enables the OTP image write operation.
<ul style="list-style-type: none"> <li>● No check</li> <li>● Check empty</li> <li>● Check if data match</li> </ul>	<p>Memory protection options:</p> <p><b>No check:</b> No protection is enabled. PLT will attempt to burn the OTP memory without running any check.</p> <p><b>Check empty:</b> PLT will first check if the OTP memory to be burned is empty, and if it is it will then proceed to burn it.</p> <p><b>Check if data match:</b> PLT will first check if the memory to be burned is empty. If it is not then it will compare its contents with the data to be burned. If the data are not the same the test will fail without making any change to the memory. For DA14585/6 devices if the data are the same PLT will not perform any burning to the memory to prevent using the OTP repair memory for these devices. For the DA14580/1/2/3 devices PLT will burn again the same data to the memory.</p>
Verify image	If this option is enabled, the PLT reads back the contents of the OTP memory and compares them to the original image file. If these do not match, the OTP memory programming will fail.
Different image per DUT	If this option is selected, a different image per DUT can be burned into the OTP. The image name must be specific for each DUT, as described below.
Image path	<p>Via this field the user specifies the image file to be burned into the OTP. A .bin binary file of any name can be selected.</p> <p>If option <i>Different image per DUT</i> is selected, the user only selects the directory of the images. In that case the binary file names must have the following format: <i>img_0X.bin</i>, where 'X' denotes the DUT number. For example, if the user has activated DUTs 1, 5 and 10 then <i>img_01.img</i>, <i>img_05.img</i> and <i>img_10.img</i> binary files should exist in the selected OTP image path as shown in Figure 64.</p>

### DA1458x/DA1468x Production Line Tool

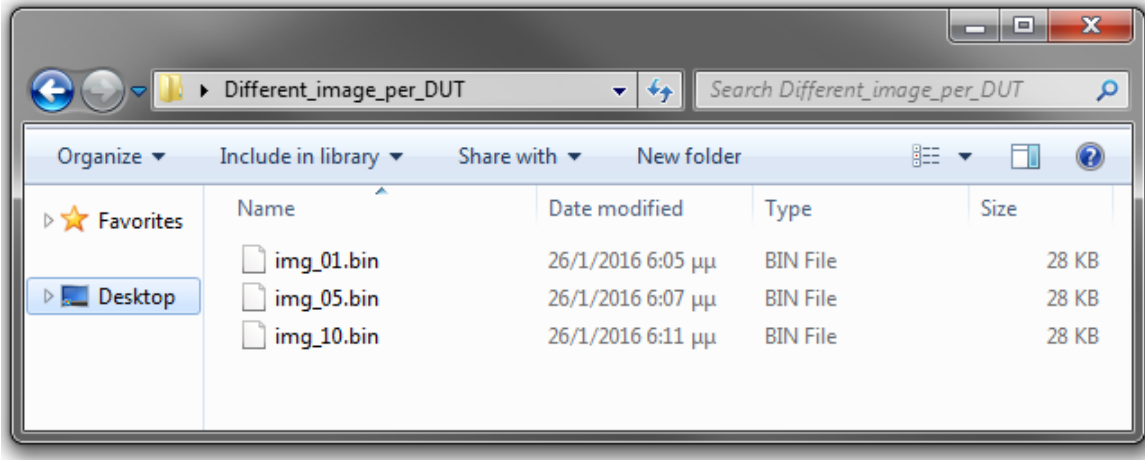

Figure 64: Different Image per DUT Folder Example

#### 7.2.7.2 SPI Flash Memory

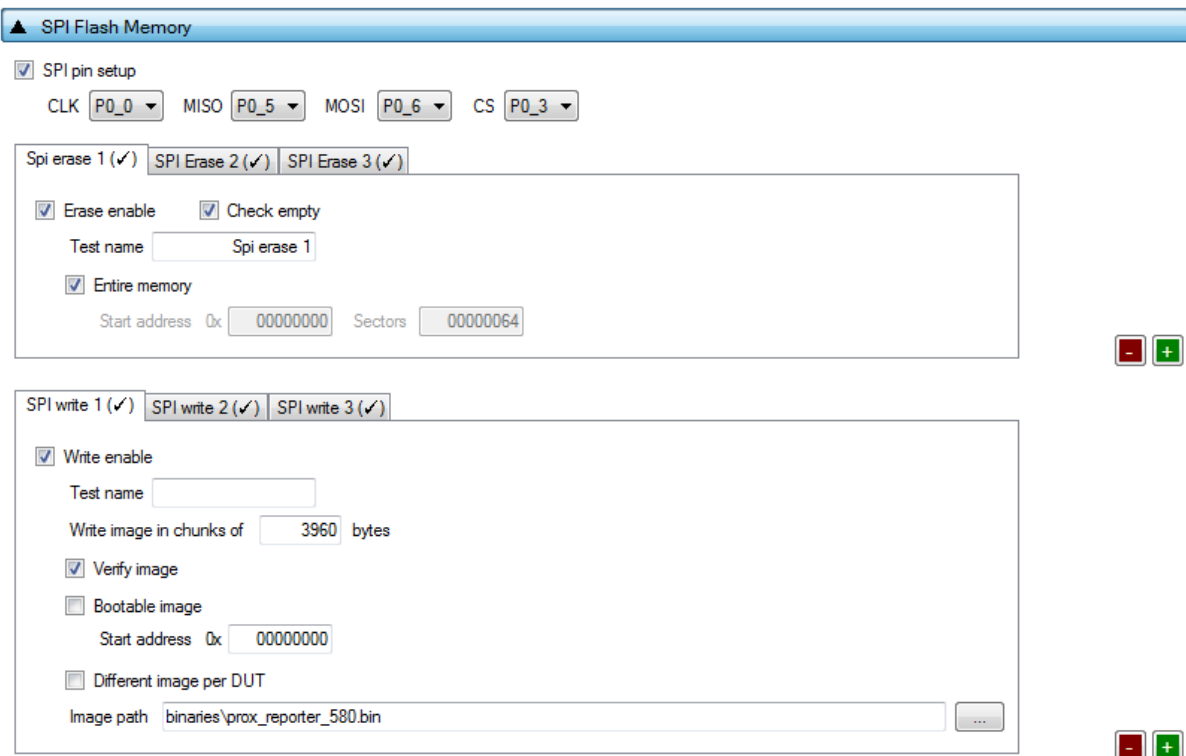

Figure 65: SPI Flash Memory - DA1458x



This section explains the settings of the SPI Flash Memory operations. [Table 53](#) describes the available options for the *SPI Pin Setup*.

Table 53: SPI Pin Setup - DA1458x

Option	Description
SPI pin setup	This option enables the SPI pin selections. If this option is disabled default pin configuration will be used. For the DA14583 and DA1586 this option will be disabled and their default pin configuration as described in <a href="#">Appendix I</a> and <a href="#">Appendix J</a> will be used.

DA1458x/DA1468x Production Line Tool

Option	Description
CLK	Sets the GPIO for the CLK pin of the SPI bus. Default GPIO pin is P0_0.
MISO	Sets the GPIO for the MISO pin of the SPI bus. Default GPIO pin is P0_5.
MOSI	Sets the GPIO for the MOSI pin of the SPI bus. Default GPIO pin is P0_6.
CS	Sets the GPIO for the CS pin of the SPI bus. Default GPIO pin is P0_3.

Both erase and write tests can have multiple instances with different settings. Tests can be added and removed using the two buttons (e.g.  and  in Figure 65) at the bottom right side of each panel.

**Note:** When adding or removing a test all settings are refreshed with the values written to the XML file, meaning that any unsaved settings will be lost.

The SPI Flash memory should be erased before any image is written to it. Table 54 describes the available options for the *SPI Flash Erase* operation.

**Table 54: SPI Flash Erase - DA1458x**

Option	Description
Erase enable	This option will enable the specific SPI Flash erase test.
Check empty	After Flash erasure the PLT software can verify the erasure result by sending a specific command to the <code>flash_programmer.bin</code> firmware running in the DUT. The firmware will read the SPI Flash memory and check if it is empty. The result will be returned to the PLT software.
Test name	The name assigned to each test. If this field is non-empty, then the assigned name will be shown on the tab and next to it an indication showing whether the specific test is enabled or not.
Entire memory	When this checkbox is selected, the entire memory can be erased. Otherwise, the user can give a start address and a specific number of sectors to be erased.
Start address	The user can enter a specific start address for the SPI Flash erasure to start.
Sectors	The number of sectors to erase, starting from the <i>Start address</i> explained above.

After every SPI Flash erase operation has finished, the SPI image write tests will begin. Table 55 describes the available options for the *SPI Flash Image Write* operation.

**Table 55: SPI Flash Image Write - DA1458x**

Option	Description
Write enable	This will enable the specific SPI Flash image programming operation.
Test name	The name assigned to each test. If this field is non-empty, then the assigned name will be shown on the tab and next to it an indication showing whether the specific test is enabled or not.
Write image in chunks of "user_input" bytes.	During memory programming PLT will split the image into chunks. The size of the chunks is user defined using this field. Values from 1 byte to 32760 bytes are supported.
Verify image	By selecting this option the PLT software will read back the contents of the SPI Flash memory, after an image was burned, and compare them to the original image file. If these do not match then the SPI memory programming will fail.
Bootable image	When selecting this checkbox the PLT software will write a boot header at SPI address 0 and will always burn the image at SPI address 0x8.
Start address	The user can configure the SPI Flash start address where the image will be written. If <i>Bootable image</i> is selected, this option will be disabled.

DA1458x/DA1468x Production Line Tool

Option	Description
Different image per DUT	If this option is selected, a different image per DUT can be burned into the SPI Flash. The image name must be specific for each DUT, as described below.
Image path	Via this field the user specifies the image file to be burned into the SPI Flash memory. A .bin binary file of any name can be selected.  If option <i>Different image per DUT</i> is selected the user only selects the directory of the images. In that case, the binary file names must have the following format: <code>img_0X.bin</code> , where 'X' denotes the DUT number. For example, if the user has activated DUTs 1, 5 and 10 then <code>img_01.img</code> , <code>img_05.img</code> and <code>img_10.img</code> binary files should exist in the selected SPI image path, as shown in <a href="#">Figure 64</a> .

7.2.7.3 I2C EEPROM Memory

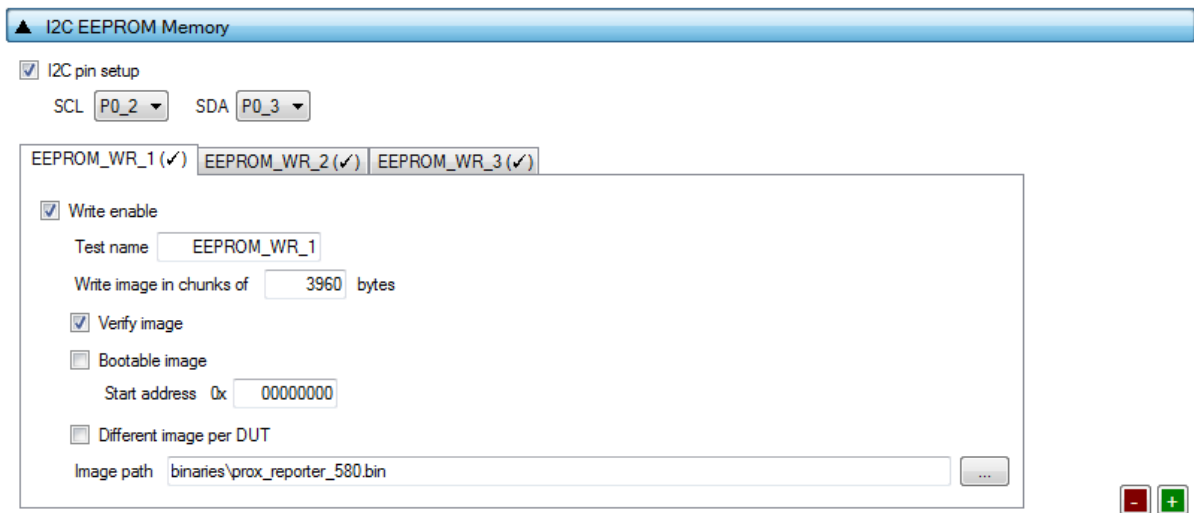

Figure 66: I2C EEPROM Memory - DA1458x

In this section an I2C EEPROM memory can be programmed. [Table 56](#) describes the available options for the *I2C Pin Setup*.

Table 56: I2C Pin Setup - DA1458x

Option	Description
I2C pin setup	This option enables the I2C pin selections. If this option is disabled, the default pin configuration will be used.
SCL	Sets the GPIO for the SCL pin of the I2C bus. Default GPIO pin is P0_2.
SDA	Sets the GPIO for the SDA pin of the I2C bus. Default GPIO pin is P0_3.

The I2C EEPROM image write tests can be performed multiple times with different settings each time. Tests can be added and removed using the two buttons (e.g. and in [Figure 66](#)) at the bottom right side of each panel.

**Note:** When adding or removing a test all settings are refreshed with the values written to the XML file, meaning that any unsaved settings will be lost.

[Table 57](#) describes the available options for the *I2C EEPROM Image Write* operation.

Table 57: I2C EEPROM Image Write - DA1458x

Option	Description
Write enable	This will enable the specific I2C/EEPROM image programming test.

DA1458x/DA1468x Production Line Tool

Option	Description
Test name	The name assigned to each test. If this field is non-empty, then the assigned name will be shown on the tab and next to it an indication showing whether the specific test is enabled or not.
Write image in chunks of "user_input" bytes.	During memory programming PLT will split the image into chunks. The size of the chunks is user defined using this field. Values from 1 byte to 32760 bytes are supported.
Verify image	By selecting this option the PLT software will read back the contents of the EEPROM and compare them to the original image file. If these do not match then the EEPROM memory programming will fail.
Bootable image	When selecting this checkbox the PLT software will write a boot header at EEPROM address 0 and will always burn the image at the EEPROM address 0x20.
Start address	Users can configure the start EEPROM address that the image will be written at. If <i>Bootable image</i> is selected, this option is disabled.
Different image per DUT	If this option is selected, a different image per DUT can be burned into the EEPROM memory. The image name must be specific for each DUT, as described below.
Image path	This field specifies the image file to be burned into the EEPROM memory. A .bin binary file of any name can be selected.  If option <i>Different image per DUT</i> is selected, the user only selects the directory of the images. In that case the binary file names must have the following format: <i>img_0X.bin</i> , where 'X' denotes the DUT number. For example, if the user has activated DUTs 1, 5 and 10 then <i>img_01.img</i> , <i>img_05.img</i> and <i>img_10.img</i> binary files should exist in the selected image path, as shown in <a href="#">Figure 64</a> .

7.2.7.4 Memory read

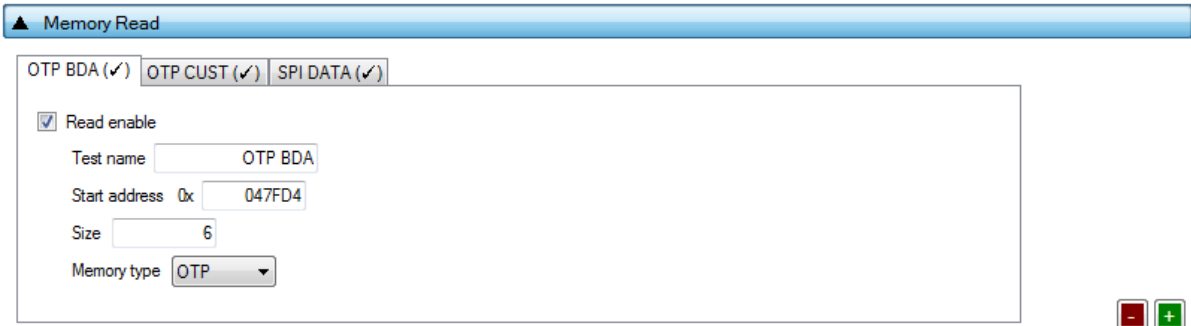

Figure 67: Memory Read Test - DA1458x

Memory Read Tests can have multiple instances with different settings. Tests can be added or removed using the two buttons (e.g. and in [Figure 67](#)) at the bottom right side of each panel.

**Note:** When adding or removing a test, all settings are refreshed with the values written to the XML file, meaning that any unsaved settings will be lost.

[Table 58](#) describes the memory read test options. With this test the user can read up to 256 bytes of data from any address from any available memory for the DA1580/1/2/3/5/6 devices, such as OTP, SPI Flash and EEPROM.

Table 58: Memory Read Test - DA1458x

Option	Description
Read enable	This will enable the specific memory reading test.
Test name	The name assigned to each test. If this field is non-empty, then the assigned name will be shown on the tab and next to it an indication showing whether the specific test is enabled or not.

DA1458x/DA1468x Production Line Tool

Option	Description
Start address	Configures the Start address for the read test. For the OTP memory of the DA14580/1/2/3 devices 0x40000 offset should be used (e.g. BD address is written in 0x47FD4), for the DA14585/6 devices this is not needed (e.g. BD address is written in 0xFFA8). DA14580/1/2/3 OTP valid address is 0x40000 to 0x47FFF and DA14585/6 OTP address 0x0000 – 0x10000.
Size	Number of bytes to read, up to 256 bytes.
Memory type	The type of memory to read the data from. Available options are: OTP, SPI FLASH, and I2C EEPROM. <b>Note:</b> For the FLASH and EEPROM memories the pin configurations are taken from the <a href="#">SPI Flash Memory</a> and <a href="#">I2C EEPROM Memory</a> sections. These options must be enabled in order for the <i>Memory Read</i> test to operate successfully.

7.2.8 Memory Header (DA1458x)

This section describes the OTP Header programming settings available when using DA14580, DA14581, DA14582, or DA14583 devices.

7.2.8.1 General

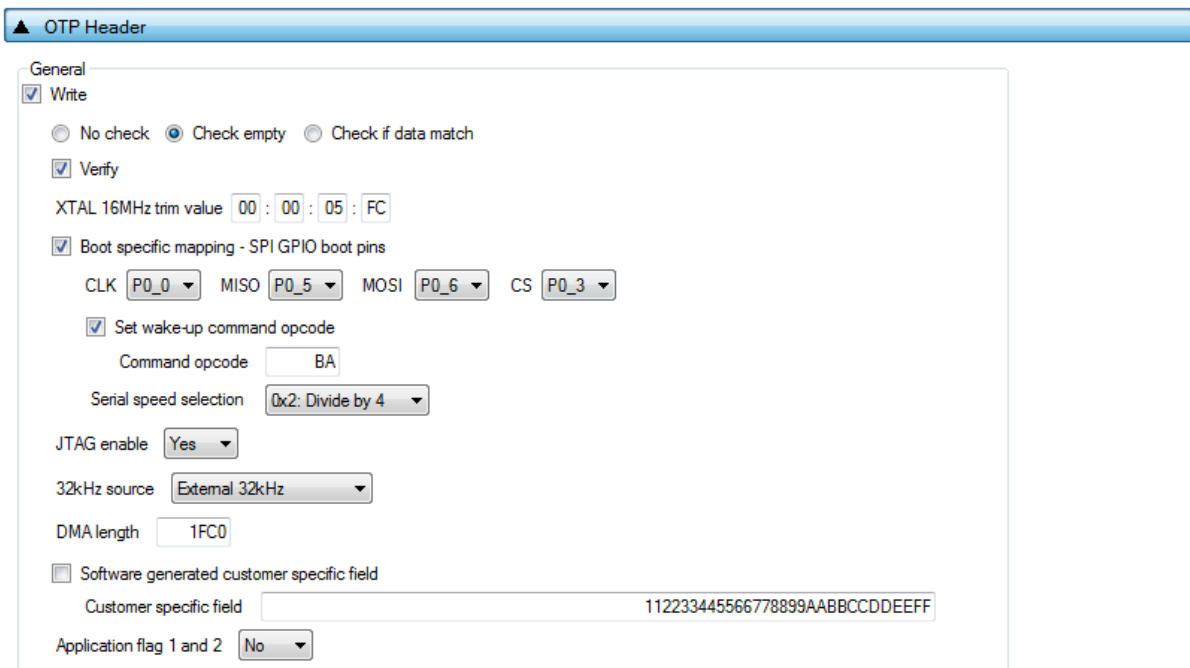

Figure 68: OTP Header - DA1458x

Table 59 describes the available options for DA1458x *OTP Header* programming.

Table 59: OTP Header - DA1458x

Option	Description
Write	This option enables the OTP header programming.



**DA1458x/DA1468x Production Line Tool**

Option	Description
<ul style="list-style-type: none"> <li>• No check</li> <li>• Check empty</li> <li>• Check if data match</li> </ul>	<p>Memory protection options:</p> <p><b>No check:</b> No protection is enabled. PLT will attempt to burn the OTP memory without running any check.</p> <p><b>Check empty:</b> PLT will first check if the OTP memory to be burned is empty, and if it is it will then proceed to burn it.</p> <p><b>Check if data match:</b> PLT will first check if the memory to be burned is empty. If it is not then it will compare its contents with the data to be burned. If the data are not the same the test will fail without making any change to the memory. For DA14585/6 devices if the data are the same PLT will not perform any burning to the memory to prevent using the OTP repair memory for these devices. For the DA14580/1/2/3 devices PLT will burn again the same data to the memory.</p>
Verify	Each value written in the OTP header can be read back and compared with the original one to verify a successful write.
XTAL trim calibration flag (Only for DA14580/1/2/3 Devices)	If Burn to OTP in <a href="#">XTAL Trim</a> is selected, this option is disabled as the XTAL trim value and flag will be burned during the automatic calibration process. If these are not executed, the users have the option to manually write the OTP XTAL trim value and enable the calibration flag here.
XTAL 16 MHz trim value	Crystal calibration value common to all devices. Can be burned only if the automatic crystal frequency calibration process and Burn to OTP in <a href="#">XTAL Trim</a> are disabled and XTAL trim calibration flag is enabled (only for DA14580/1/2/3 devices).
Boot specific mapping – SPI GPIO boot pins (only for DA14585 devices)	Enables external booting from a specific SPI interface configuration. This option also enables the following options for the SPI flash boot configuration for the DA14585 devices. <b>Note:</b> In DA14586 the boot specific mapping section is already pre-programmed with the internal SPI pins as described in <a href="#">Appendix J</a> . If this is needed to be changed for DA14586 DUTs, this area can be written as a DA14585 device and it will be overridden using an OTP memory repair cell.
CLK (only for DA14585 devices)	Sets the GPIO for the CLK pin of the SPI bus.
MISO (only for DA14585 devices)	Sets the GPIO for the MISO pin of the SPI bus.
MOSI (only for DA14585 devices)	Sets the GPIO for the MOSI pin of the SPI bus.
CS (only for DA14585 devices)	Sets the GPIO for the CS pin of the SPI bus.
Set wake-up command opcode (only for DA14585 devices)	Default wake-up command opcode is “AB”. If a different one is needed to be used it can be set using this flag and the following field.
Command opcode (only for DA14585 devices)	The command opcode to be used.
Serial speed selection (only for DA14585 devices)	Division factor for SPI.
JTAG enable	Enable the JTAG support.
32 kHz source	Selects the low power 32 kHz clock source.
DMA length	The size (in words) for the DMA controller to copy from OTP to system RAM during boot. Should match the OTP image size. Max value for the DA14580-1-2-3 devices is 0x1FC0. Max value for the DA14585-6 devices is 0x3E00.

DA1458x/DA1468x Production Line Tool

Option	Description
Software generated specific field	When enabled, a PLT software function will be called that can generate a customer specific field per DUT. Users can edit this function by adding their code for creating the customer specific field. For the CLI executable this function is called: <code>int cli_sw_customer_field(cfg_params *cfg_params_t);</code> For the GUI executable the function is called: <code>void gui_plt_sw_customer_field(cfg_params *cfg_params_t);</code>
Customer specific field	If option <i>Software generated customer specific field</i> is not set, the user can manually enter the value to be written into the DUT OTP. The same value will be programmed to all DUTs.
Application flag 1 and 2	If this option is set, the device will boot only from the OTP memory. Used for a production ready device. There is no other means to access the device apart from JTAG, if this is still enabled in the OTP header.

7.2.8.2 BD Address

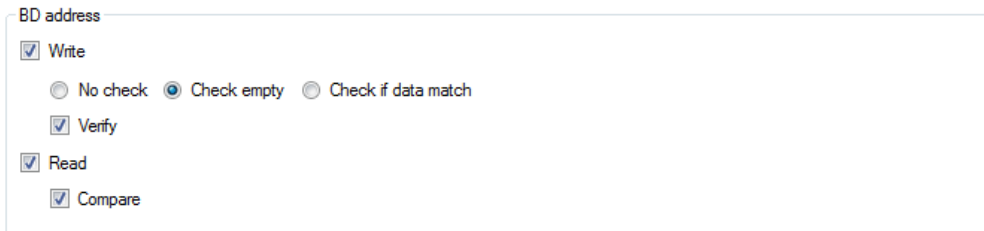

Figure 69: BD Address - DA1458x

The BD address can be written independently from the rest OTP header options described before. [Table 60](#) describes the available options for the *BD Address* programming.

Table 60: BD Address - DA1458x

Option	Description
Write	When selected, the BD address will be written in the OTP Header.
<ul style="list-style-type: none"> <li>No check</li> <li>Check empty</li> <li>Check if data match</li> </ul>	<p>Memory protection options:</p> <p><b>No check:</b> No protection is enabled. PLT will attempt to burn the OTP memory without running any check.</p> <p><b>Check empty:</b> PLT will first check if it the OTP memory to be burned is empty, and if it is it will then proceed to burn it.</p> <p><b>Check if data match:</b> PLT will first check if the memory to be burned is empty. If it is not then it will compare its contents with the data to be burned. If the data are not the same the test will fail without making any change to the memory. For DA14585/6 devices if the data are the same PLT will not perform any burning to the memory to prevent using the OTP repair memory for these devices. For the DA14580/1/2/3 devices PLT will burn again the same data to the memory.</p>
Verify	When selected, the BD address will be read back from the OTP Header and will be compared to the original.
Read	This option will read the BD address written in the OTP Header field. It is a standalone memory operation. It does not depend on the previous tests to run, but it is necessary for the following <i>Compare</i> test.
Compare	If the <i>Read</i> option is enabled, a comparison will be performed between the read BD address and the BD address entered in the DUT by the PLT, as described in the BD address DUT assignment method.

DA1458x/DA1468x Production Line Tool

7.2.8.3 Custom Memory Data

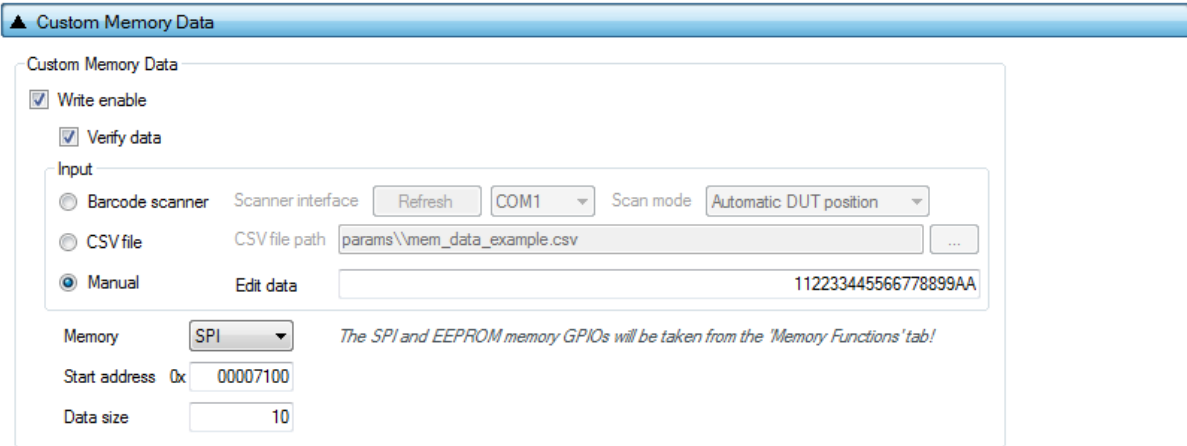

Figure 70: Custom Memory Data - DA1458x

Table 61: Custom Memory Data - DA1458x

Option	Description								
Write enable	This option enables the Custom data programming.								
Verify data	When selected, the data written will be read back from the memory and will be compared to the original.								
<ul style="list-style-type: none"> <li>Barcode scanner</li> <li>CSV file</li> <li>Manual data</li> </ul>	<p>Custom data input options:</p> <table border="1"> <tr> <td>Scanner interface (Barcode scanner)</td> <td> <p>Selection of the barcode scanner COM port from a dropdown list with all the available system COM ports.</p> <p>A common USB to UART barcode scanner is supported. PLT has been tested with Honeywell Xenon 1900. <a href="#">Appendix K</a> describes the setup procedure.</p> <p><b>This option is the exact same option as in Scan Mode and the DA1468x devices in Custom Memory Data.</b></p> </td> </tr> <tr> <td>Scan mode (Barcode scanner)</td> <td> <p><b>Scan DUT position:</b> In this mode the users must first scan the DUT position number and then the BD address. The string used for the position of each DUT is "TEST POSITION 0xx" where "xx" is the DUT position number.</p> <p><b>Automatic DUT position:</b> Scanned BD address will be assigned to the selected DUT. The DUT selection is automatically been made, starting from the first active DUT and selecting the next one after a successful BD address scan. Users can change the selected DUT using the controls on the GUI PLT screen shown in <a href="#">Figure 102</a>.</p> <p><b>This option is the exact same option as in Scan Mode and the DA1468x devices in Custom Memory Data.</b></p> </td> </tr> <tr> <td>CSV file path (CSV file)</td> <td>Path to the CSV file containing data for each device discriminated using BD addresses. The CSV file format is described in <a href="#">Custom data CSV file format</a>.</td> </tr> <tr> <td>Edit data (Manual data)</td> <td>Hexadecimal data input of up to 256 bytes to burn. These data will be burned to all active DUTs.</td> </tr> </table>	Scanner interface (Barcode scanner)	<p>Selection of the barcode scanner COM port from a dropdown list with all the available system COM ports.</p> <p>A common USB to UART barcode scanner is supported. PLT has been tested with Honeywell Xenon 1900. <a href="#">Appendix K</a> describes the setup procedure.</p> <p><b>This option is the exact same option as in Scan Mode and the DA1468x devices in Custom Memory Data.</b></p>	Scan mode (Barcode scanner)	<p><b>Scan DUT position:</b> In this mode the users must first scan the DUT position number and then the BD address. The string used for the position of each DUT is "TEST POSITION 0xx" where "xx" is the DUT position number.</p> <p><b>Automatic DUT position:</b> Scanned BD address will be assigned to the selected DUT. The DUT selection is automatically been made, starting from the first active DUT and selecting the next one after a successful BD address scan. Users can change the selected DUT using the controls on the GUI PLT screen shown in <a href="#">Figure 102</a>.</p> <p><b>This option is the exact same option as in Scan Mode and the DA1468x devices in Custom Memory Data.</b></p>	CSV file path (CSV file)	Path to the CSV file containing data for each device discriminated using BD addresses. The CSV file format is described in <a href="#">Custom data CSV file format</a> .	Edit data (Manual data)	Hexadecimal data input of up to 256 bytes to burn. These data will be burned to all active DUTs.
Scanner interface (Barcode scanner)	<p>Selection of the barcode scanner COM port from a dropdown list with all the available system COM ports.</p> <p>A common USB to UART barcode scanner is supported. PLT has been tested with Honeywell Xenon 1900. <a href="#">Appendix K</a> describes the setup procedure.</p> <p><b>This option is the exact same option as in Scan Mode and the DA1468x devices in Custom Memory Data.</b></p>								
Scan mode (Barcode scanner)	<p><b>Scan DUT position:</b> In this mode the users must first scan the DUT position number and then the BD address. The string used for the position of each DUT is "TEST POSITION 0xx" where "xx" is the DUT position number.</p> <p><b>Automatic DUT position:</b> Scanned BD address will be assigned to the selected DUT. The DUT selection is automatically been made, starting from the first active DUT and selecting the next one after a successful BD address scan. Users can change the selected DUT using the controls on the GUI PLT screen shown in <a href="#">Figure 102</a>.</p> <p><b>This option is the exact same option as in Scan Mode and the DA1468x devices in Custom Memory Data.</b></p>								
CSV file path (CSV file)	Path to the CSV file containing data for each device discriminated using BD addresses. The CSV file format is described in <a href="#">Custom data CSV file format</a> .								
Edit data (Manual data)	Hexadecimal data input of up to 256 bytes to burn. These data will be burned to all active DUTs.								
Memory	<p>Memory type selection to burn the data. Available options are OTP, SPI and EEPROM.</p> <p><b>Note:</b> For the FLASH and EEPROM memories the pin configurations are taken from the <a href="#">SPI Flash Memory</a> and <a href="#">I2C EEPROM Memory</a> sections. These options must be enabled in order for the <i>Memory Read</i> test to operate successfully.</p>								

DA1458x/DA1468x Production Line Tool

Option	Description
Start address	Memory address offset to begin burning the data. DA14580/1/2/3 OTP valid address is 0x40000 to 0x47FFF and DA14585/6 OTP address 0x0000 – 0x10000.
Data size	The size of the memory data to burn. In barcode scanner, the data size is the number of scanned ASCII characters. In manual data, data size is the number of bytes.

7.2.9 UART (DA1468x)

7.2.9.1 UART Boot Pins Setup

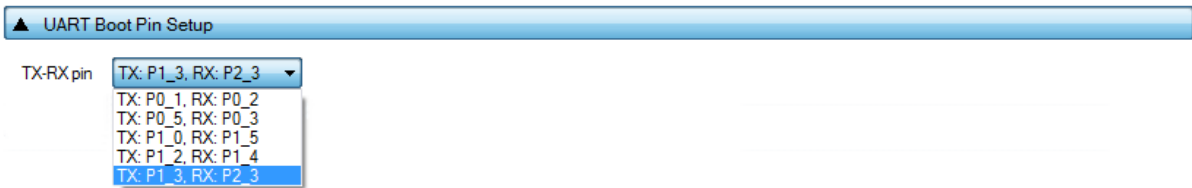

Figure 71: UART Boot Pins Setup - DA1468x

Table 62 describes the available options for the TX-RX pins of the DA1468x *UART Boot Pins Setup*. The TX-RX pins selection defines the UART pins and baud rate setup that will be used for firmware downloading to the DA1468x during booting.

Table 62: UART TX-RX Pins - DA1468x

Option	Description
TX: P0_1, RX: P0_2	Sets UART TX pin to P0_1, UART RX pin to P0_2 and Baud rate to 115200 bit/s.
TX: P0_5, RX: P0_3	Sets UART TX pin to P0_5, UART RX pin to P0_3 and Baud rate to 57600 bit/s.
TX: P1_0, RX: P1_5	Sets UART TX pin to P1_0, UART RX pin to P1_5 and Baud rate to 57600 bit/s.
TX: P1_2, RX: P1_4	Sets UART TX pin to P1_2, UART RX pin to P1_4 and Baud rate to 57600 bit/s.
TX: P1_3, RX: P2_3	Sets UART TX pin to P1_3, UART RX pin to P2_3 and Baud rate to 57600 bit/s.

**Note:** The baud rate is fixed during booting, since it is controlled by the device ROM bootloader.

7.2.9.2 UART Baud Rate

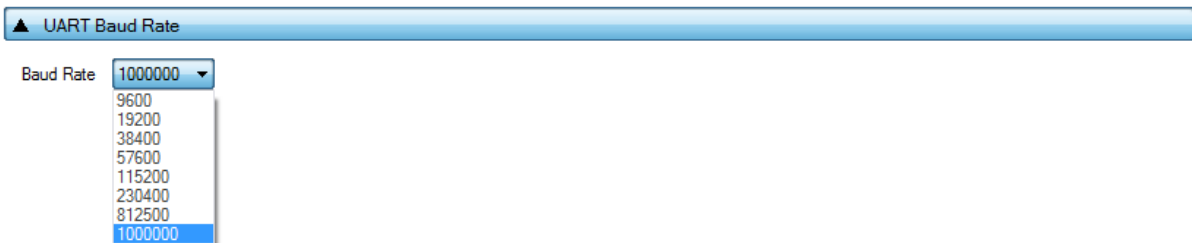

Figure 72: UART Baud Rate - DA1468x

Table 63 shows the available options for the DA1468x *UART Baud Rate* used during memory programming only.

The *Baud Rate* selected here is used after the firmware (`uartboot.bin`) has been downloaded to the DUT. The software will send a command to the DUT to change the UART baud rate to the one selected here. All following UART communications with the DUT will be performed using the new baud rate. Please note that this is happening only during memory programming where `uartboot.bin`

## DA1458x/DA1468x Production Line Tool

is used. During tests (RF tests, XTAL trimming, etc.), where the production test firmware is used, the baud rate is fixed at 115200 bit/s.

**Table 63: UART Baud Rate - DA1468x**

Option	Description
Baud Rate	<ul style="list-style-type: none"> <li>• 9600 (bit/s)</li> <li>• 19200 (bit/s)</li> <li>• 38400 (bit/s)</li> <li>• 57600 (bit/s)</li> <li>• 115200 (bit/s)</li> <li>• 230400 (bit/s)</li> <li>• 1000000 (bit/s)</li> </ul> <p><b>Note:</b> 1 Mbit/s is the fastest and safest with 0% baud rate error.</p>

### 7.2.10 Test Settings (DA1468x)

#### 7.2.10.1 XTAL Trim

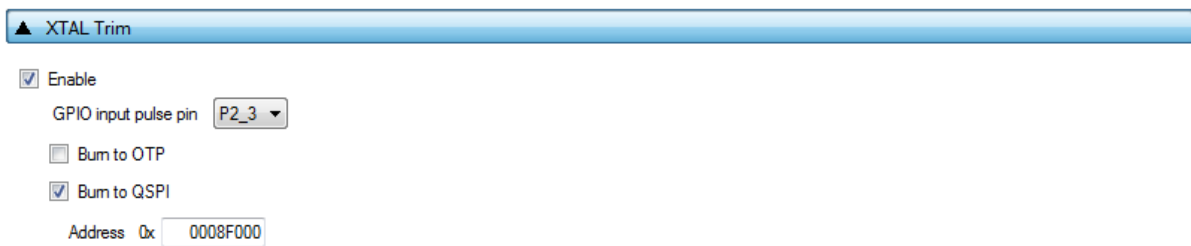

**Figure 73: XTAL Trim - DA1468x**

Table 64 describes the available options for the DA1468x XTAL Trim operation.

**Table 64: XTAL Trim - DA1468x**

Option	Description
Enable	This option enables the automatic crystal oscillator frequency calibration procedure.
GPIO input pulse pin	The DUT GPIO to receive the reference pulse during calibration. UART RX pin can be used without any additional connection from the PLT hardware to the DUT.
Burn to OTP	If <i>Burn to OTP</i> option is selected, the XTAL trim value calculated from the automated calibration process will be written in the OTP XTAL trim header field.
Burn to QSPI	If selected, the XTAL trim value calculated from the automated calibration process will be written in the QSPI Flash.
Address	The QSPI Flash address where the XTAL trim value will be written. Default value is 0x0008F000.

#### 7.2.10.2 RF Tests

This section refers to various RF tests conducted between the DUTs and the Golden Unit or an external BLE tester.

The following tests can have multiple instances with different settings. Tests can be added and removed using the two buttons (e.g. and in Figure 74) at the bottom right side of each panel.

**Note:** When adding or removing a test all settings are refreshed with the values written to the XML file, meaning that any unsaved settings will be lost.

DA1458x/DA1468x Production Line Tool

Golden Unit

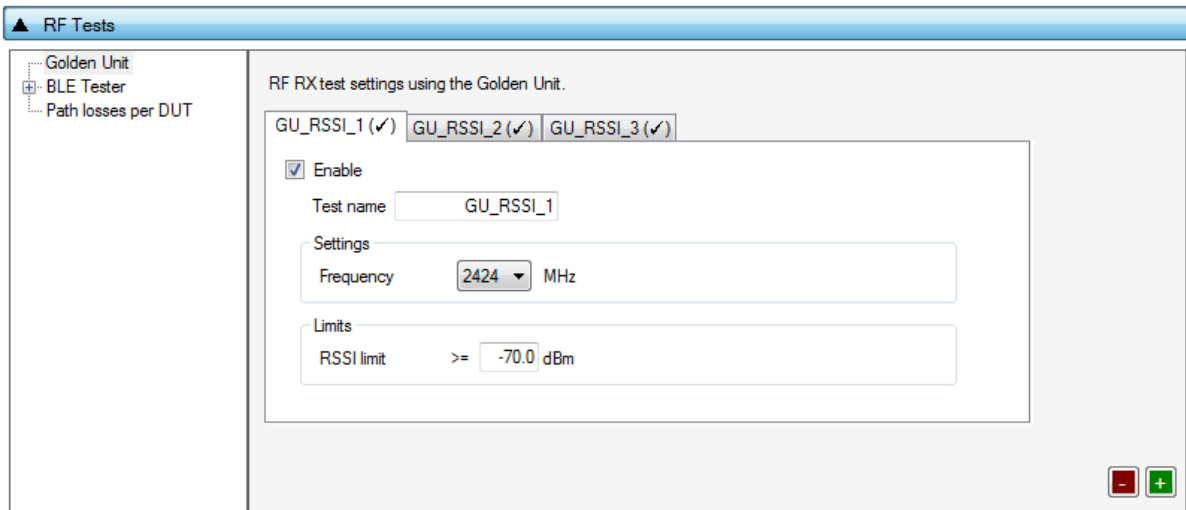

Figure 74: Golden Unit RF Tests - DA1468x

Table 65 describes the available options for the DA1468x RF RX test using the Golden Unit as a transmitter.

In the RF RX test the Golden Unit sends 500 packets. The DUTs are set in receive mode and the RSSI is measured. If the RSSI measured by the DUT reception is less than the specified RSSI limit, the device will fail and the tests will stop for that particular device.

Table 65: Golden Unit RF Tests - DA1468x

Option	Description
Enable	This option enables the specific RF RX test using the Golden Unit as a transmitter.
Test name	The name assigned to each test. If this field is non-empty, then the assigned name will be shown on the tab and next to it an indication showing whether the specific test is enabled or not.
Frequency	The BLE channel frequency used in the RF RX test using the Golden Unit.
RSSI limit	The RSSI limit for pass/fail criteria in the RF RX test using the Golden Unit. If the average RSSI of the device after it has received the packets transmitted from the Golden Unit is less than this value, the test will be considered as failed.

DA1458x/DA1468x Production Line Tool

BLE Tester

In the *BLE Tester* panels a number of tests can be enabled that require an external BLE tester instrument. More detailed information about the BLE tester can be found in [1].

BLE Tester - General

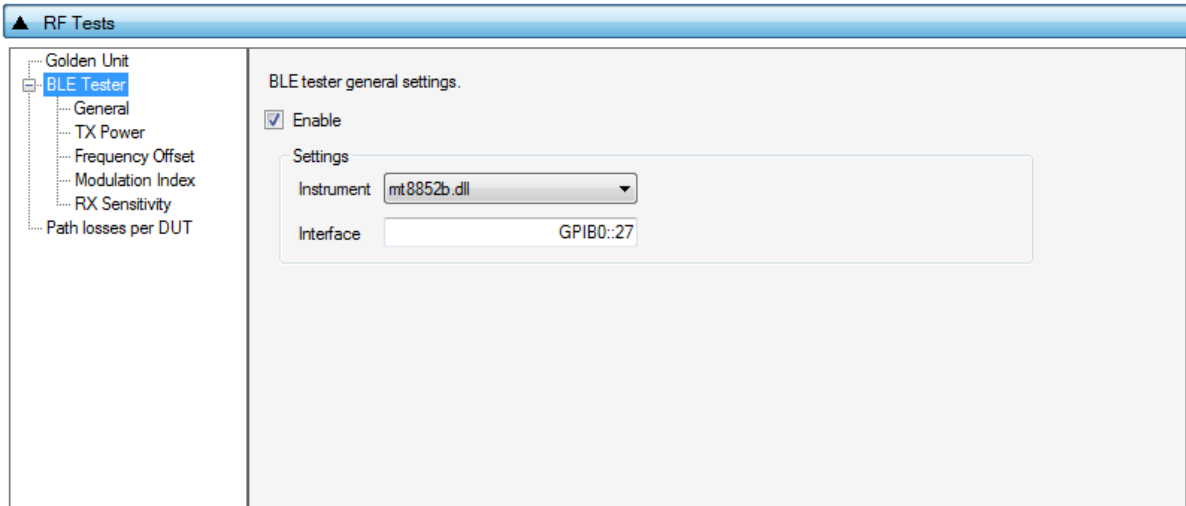

Figure 75: BLE Tester General Settings - DA1468x

Table 66 describes the *General* settings for the *BLE Tester* supported tests. Any available external instrument found by the `ble_tester_driver` DLL and their interfaces can be selected.

Table 66: BLE Tester General Settings - DA1468x

Option	Description
Enable	This option enables all of the <i>BLE Tester</i> tests, which include: <ul style="list-style-type: none"> <li>• BLE Tester TX Power</li> <li>• Frequency Offset</li> <li>• Modulation Index</li> <li>• RX Sensitivity</li> </ul>
Instrument	Selects the BLE tester DLL. Names are shown only if a BLE tester instrument DLL exists in the project folder <code>ble_tester_instr_plugins</code> .
Interface	The interface of the instrument to be used by the driver.



DA1458x/DA1468x Production Line Tool

BLE Tester - TX Power

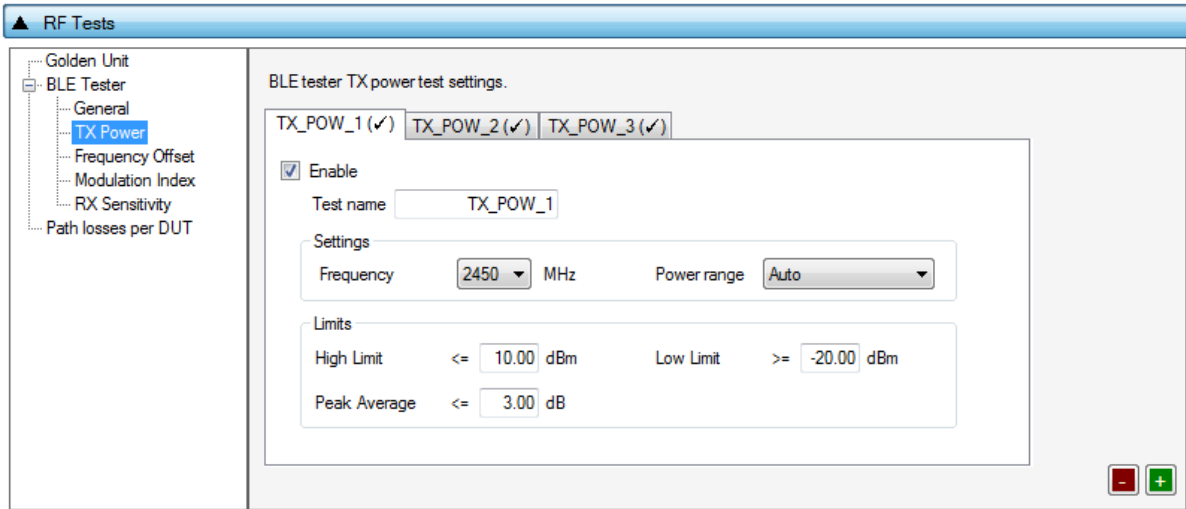

Figure 76: BLE Tester TX Power - DA1468x

Table 67 describes the available options for the DA1468x TX Power test using a BLE Tester instrument.

Table 67: BLE Tester TX Power - DA1468x

Option	Description
Enable	This option enables the specific TX power test using a BLE tester instrument.
Test name	The name assigned to each test. If this field is non-empty, then the assigned name will be shown on the tab and next to it an indication showing whether the specific test is enabled or not.
Frequency	The BLE channel frequency used in the BLE TX power test.
Power range	Set the device TX output power range. Available options are: <ul style="list-style-type: none"> <li>• Auto (No auto option for Litepoint IQxelM. Sets the instrument to trigger at -25dBm)</li> <li>• +22 dBm to +7 dBm</li> <li>• +9 dBm to -3 dBm</li> <li>• +5 dBm to -7 dBm</li> <li>• -4 dBm to -16 dBm</li> <li>• -12 dBm to -26 dBm</li> <li>• -24 dBm to -35 dBm</li> </ul> Default value is <i>Auto</i> .
High limit	Set the average high power limit for the BLE TX output power pass/fail test criteria.
Low limit	Set the average low power limit for the BLE TX output power pass/fail test criteria.
Peak average	Set the peak-to-average power limit for the BLE TX output power pass/fail test criteria.

BLE Tester - Frequency Offset

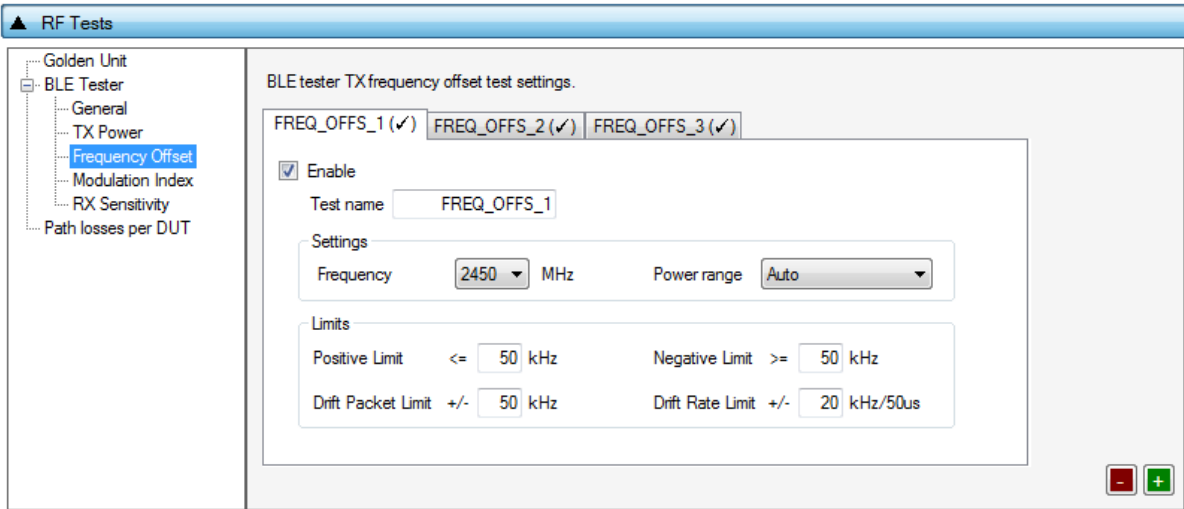

Figure 77: BLE Tester Frequency Offset - DA1468x

Table 68 describes the available options for the *Frequency Offset* test using a BLE Tester instrument.

Table 68: BLE Tester Frequency Offset - DA1468x

Option	Description
Enable	This option enables the specific TX frequency offset test using a BLE tester instrument.
Test name	The name assigned to each test. If this field is non-empty, then the assigned name will be shown on the tab and next to it an indication showing whether the specific test is enabled or not.
Frequency	The BLE channel frequency used in the BLE TX frequency offset test.
Power range	Set the device TX output power range. Available options are: <ul style="list-style-type: none"> <li>• Auto</li> <li>• +22 dBm to +7 dBm</li> <li>• +9 dBm to -3 dBm</li> <li>• +5 dBm to -7 dBm</li> <li>• -4 dBm to -16 dBm</li> <li>• -12 dBm to -26 dBm</li> <li>• -24 dBm to -35 dBm</li> </ul> Default value is <i>Auto</i> .
Positive limit	Set the maximum positive offset limit in kHz for the TX carrier frequency offset pass/fail test criteria.
Negative limit	Set the maximum negative offset limit in kHz for the TX carrier frequency offset pass/fail test criteria.
Drift packet limit	Set the overall packet drift in kHz for the TX drift pass/fail test criteria.
Drift rate limit	Set the drift rate limit in kHz/50 μs for the TX drift pass/fail test criteria.

BLE Tester - Modulation Index

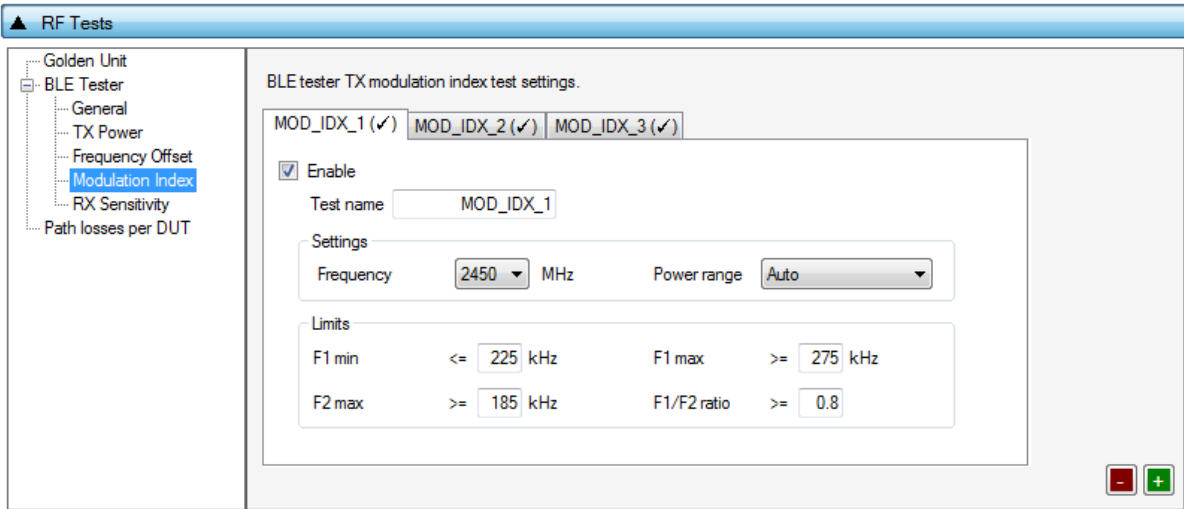

Figure 78: BLE Tester Modulation Index - DA1468x

Table 69 describes the available options for the *Modulation Index* test using a BLE Tester instrument.

Table 69: BLE Tester Modulation Index - DA1468x

Option	Description
Enable	This option enables the specific TX modulation index test using a BLE tester instrument.
Test name	The name assigned to each test. If this field is non-empty, then the assigned name will be shown on the tab and next to it an indication showing whether the specific test is enabled or not.
Frequency	The BLE channel frequency used in the BLE TX modulation index offset test.
Power range	Set the device TX output power range. Available options are: <ul style="list-style-type: none"> <li>• Auto</li> <li>• +22 dBm to +7 dBm</li> <li>• +9 dBm to -3 dBm</li> <li>• +5 dBm to -7 dBm</li> <li>• -4 dBm to -16 dBm</li> <li>• -12 dBm to -26 dBm</li> <li>• -24 dBm to -35 dBm</li> </ul> Default value is <i>Auto</i> .
F1 min	Set the F1 minimum average limit in kHz for the TX modulation index pass/fail test criteria.
F1 max	Set the F1 maximum average limit in kHz for the TX modulation index pass/fail test criteria.
F2 max	Set the F2 maximum limit in kHz for the TX modulation index pass/fail test criteria.
F1/F2 ratio	Set the F1/F2 maximum average ratio limit for the TX modulation index pass/fail test criteria.

BLE Tester - RX Sensitivity

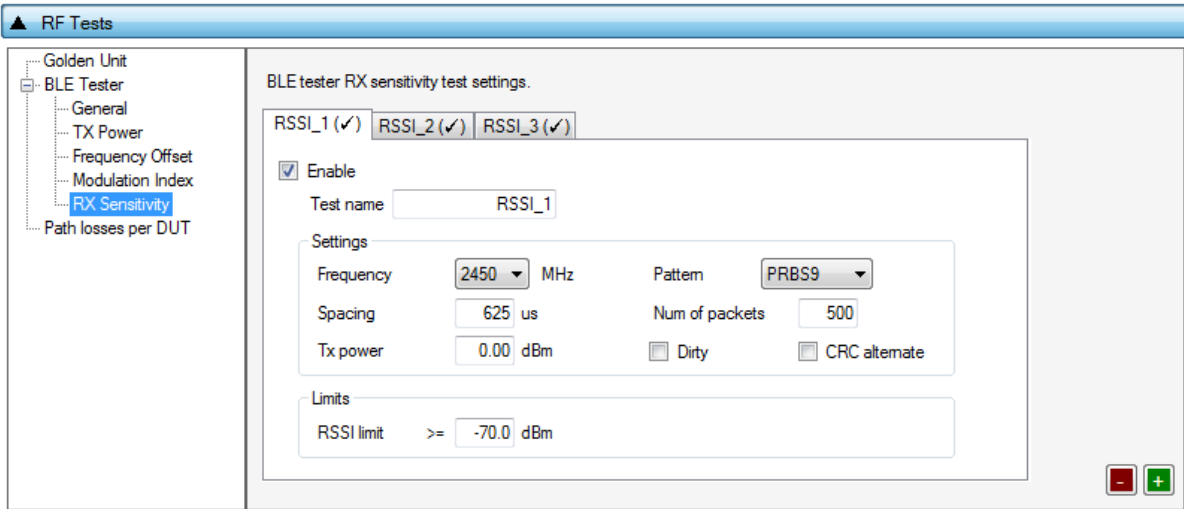

Figure 79: BLE Tester RX Sensitivity - DA1468x

Table 70 describes the available options for the *RX Sensitivity* test using a BLE Tester instrument.

Table 70: BLE Tester RX Sensitivity - DA1468x

Option	Description
Enable	This option enables the specific RX sensitivity test using a BLE tester instrument.
Test name	The name assigned to each test. If this field is non-empty, then the assigned name will be shown on the tab and next to it an indication showing whether the specific test is enabled or not.
Frequency	The BLE channel frequency used in the BLE RX sensitivity test.
Pattern	The bit pattern of the TX data. Available options are: <ul style="list-style-type: none"> <li>• PRBS9</li> <li>• 10101010</li> <li>• 11110000</li> </ul>
Spacing	The packet spacing in $\mu$ s.
Num of packets	The number of packets the BLE tester instrument to transmit.
Tx power	The TX output power of the BLE tester instrument. Suggested values are 0 to -10 dBm.
Dirty	When enabled, the BLE tester packet generator can use a dirty table to transmit.
CRC alternate	When enabled, the BLE tester will alternately send packets with CRC correct and CRC incorrect.
RSSI limit	The RSSI limit for pass/fail criteria in the RF RX sensitivity test. If the average RSSI of the device after it has received the transmitted packets is less than this value, the test will be considered as failed.

DA1458x/DA1468x Production Line Tool

Path Losses per DUT

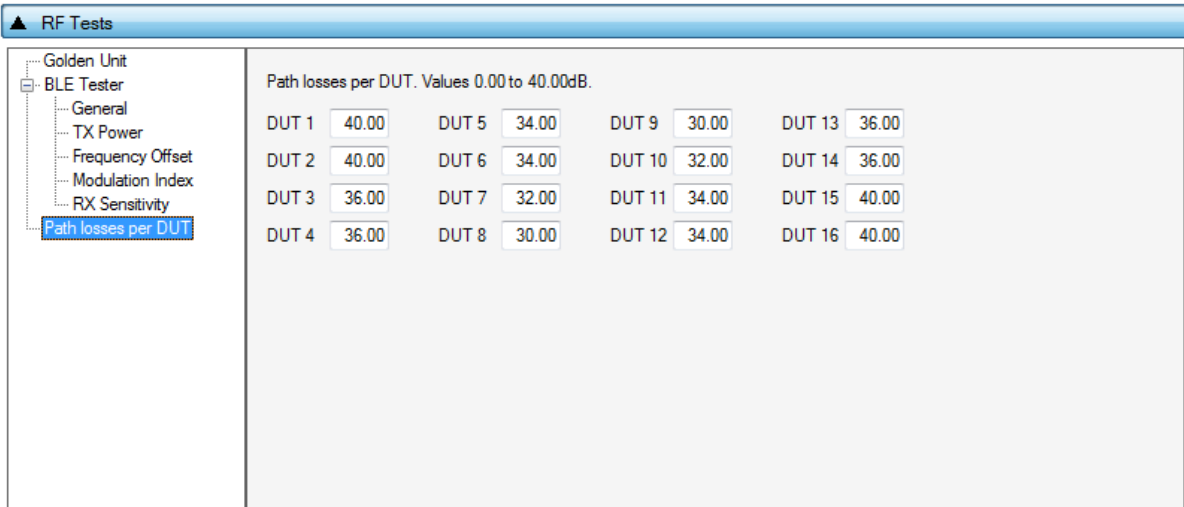

Figure 80: Path Losses per DUT - DA1468x

Table 71 describes the available options for the *Path losses per DUT*.

Based on the relative position of each DUT during the RF tests and since the RF tests are performed over the air, values can be used to correct for any path losses. These values are added to the limits of the TX Power and RF RX RSSI tests. Additional information can be found on 0.

Table 71: Path Losses per DUT from RF Tests DA1468x Options

Option	Description
DUT1-16	Set the path loss value for each DUT. These will be added as corrections to the limits of the TX Power and RF RX RSSI tests

7.2.10.3 Current Measurement Test

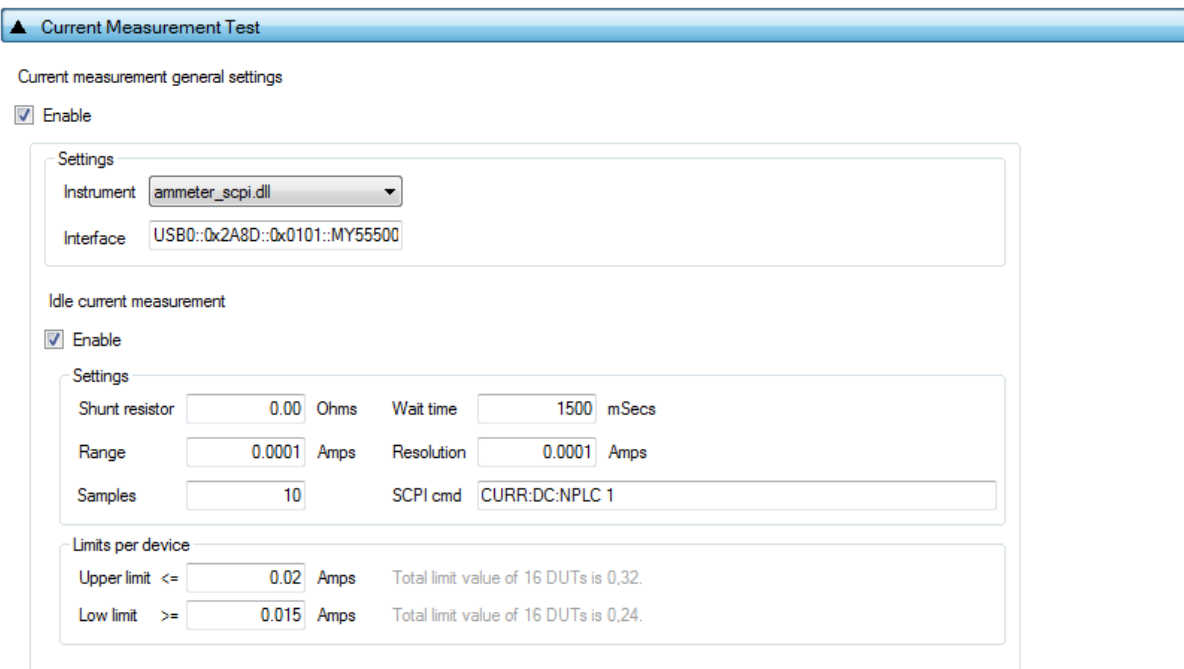

Figure 81: Current Measurement Tests - DA1468x

**DA1458x/DA1468x Production Line Tool**

In this test an external ammeter instrument can be used to calculate the total current consumption of all the active DUTs at the time of the sampling. The ammeter instrument can be connected in the blue banana plugs as described in [Current Measurements](#) or to an external power supply (if present) depending the selected [VBAT/Reset Mode](#).

During measurement PLT will control the instrument using the `ammeter_driver` DLL [1]. [Table 72](#) describes the instrument selection settings found by the `ammeter_driver` DLL and in [Table 73](#) the current measurement options for each sleep state.

**Note:** Modifications in the Production test firmware are mandatory in order to achieve the correct current consumption of a specific hardware design(IC and peripherals) for each sleep state. Running the default firmware without any modifications for the hardware design may cause increased current consumption.

**Table 72: Current Measurement Tests - DA1458x**

Option	Description
Enable	This option enables all of Current Measurement tests, which include: <ul style="list-style-type: none"> <li>• Idle Current Measurement</li> <li>• Extended Sleep Current Measurement</li> <li>• Deep Sleep Current Measurement</li> </ul> Only one of the Extended/Deep sleep current measurements can be selected, meaning that the other one will be disabled.
Instrument	Select the Ammeter instrument DLL name. Names are shown only if an ammeter instrument DLL exists in the project <code>ammeter_instr_plugins</code> folder.
Interface	The interface of the instrument to be used by the driver.

**Table 73: Current Measurement for each Sleep State**

Option	Description
Enable	This option enables the specific current measurement using the ammeter instrument provided in the <i>Instrument</i> section.
Shunt resistor	The value of the shunt resistor used for idle current measurement. Applicable only if a voltmeter or a NI-DAQ is used to measure current instead of a DMM. Values from 0 to 9999 are supported.
Wait time	The time in milliseconds the PLT will wait before taking a current measurement, after it has sent an instruction to the DUTs to go into a specific sleep state. Supported values are 1 to 500000ms.
Sleep time (only for extended sleep)	The time in seconds that the DUTs will remain in extended sleep mode. A timer in the production test firmware will wake up the devices and set them to idle mode. Supported values are 1 to 1200sec.
Range	The range value in Ampere units that the ammeter instrument will operate. Supported values are 0 to 9999 and default value is 0.001A.
Resolution	The ammeter instrument resolution value in Ampere units.
Samples	The number of samples that the ammeter instrument will read and average. 1 to 1000 is supported.
SCPI cmd	An SCPI command to be passed to the ammeter instrument just before the measurement is taken. Supports multiple commands separated with a column. Up to 256 characters are supported.

DA1458x/DA1468x Production Line Tool

Option	Description
Upper limit	The upper limit value for the extended sleep current measurement test procedure, for a single DUT. Next to this input field the total upper limit current consumption for all the enabled DUTs is shown, which is the value to be used during testing. <b>Note:</b> During testing some DUTs may fail until the current measurement test takes place, in that case the PLT will automatically re-calculate the total upper limit by using the value given for a single DUT multiplied with the number of the active DUTs at the time that the test will run.
Low limit	The low limit value for the extended sleep current measurement test procedure, for a single DUT. Next to this input field the total upper limit current consumption for all the enabled DUTs is shown, which is the value to be used during testing. <b>Note:</b> During testing some DUTs may fail until the current measurement test takes place, in that case the PLT will automatically re-calculate the total low limit by using the value given for a single DUT multiplied with the number of the active DUTs at the time that the test will run.

7.2.10.4 GPIO/LED Test

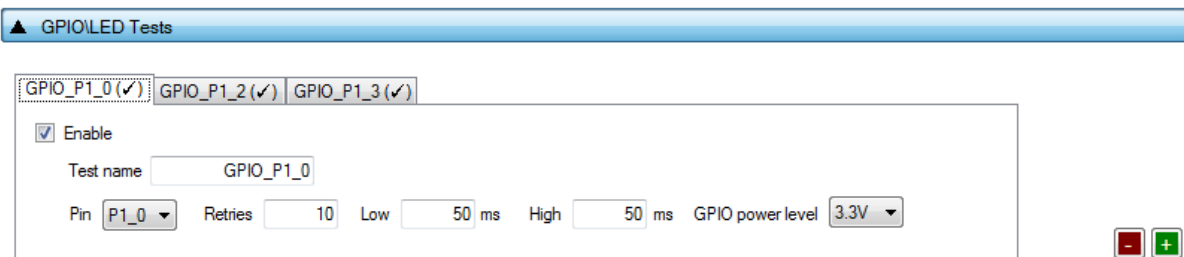



Figure 82: GPIO/LED Tests - DA1468x

GPIO/LED Tests can have multiple instances with different settings. Tests can be added or removed using the two buttons (e.g.  and  in Figure 82) at the bottom right side of each panel.

**Note:** When adding or removing a test, all settings are refreshed with the values written to the XML file, meaning that any unsaved settings will be lost.

Table 74 describes the available options for the GPIO/LED Tests DA1468x Options.

In these tests a specific pulse can be given to a GPIO and any LED connected to it can be visually tested. The Pin option sets the GPIO to be used, Low and High define the duty cycle and the Retries the number of pulses.

Table 74: GPIO/LED Tests - DA1468x

Option	Description
Enable	This option enables the GPIO/LED toggling. Can be used for visual LED testing.
Test name	The name assigned to each test. If this field is non-empty, then the assigned name will be shown on the tab and next to it an indication showing whether the specific test is enabled or not.
Pin	The GPIO that will be used for the specific test.
Retries	Number of pulses to be generated for the specific test.
Low	Sets the amount of the OFF time of the pulse in ms for the specific test.
High	Sets the amount of the ON time of the pulse in ms for the specific test.
GPIO power level	Sets the power level of the GPIOs.



7.2.10.5 Sensor Test

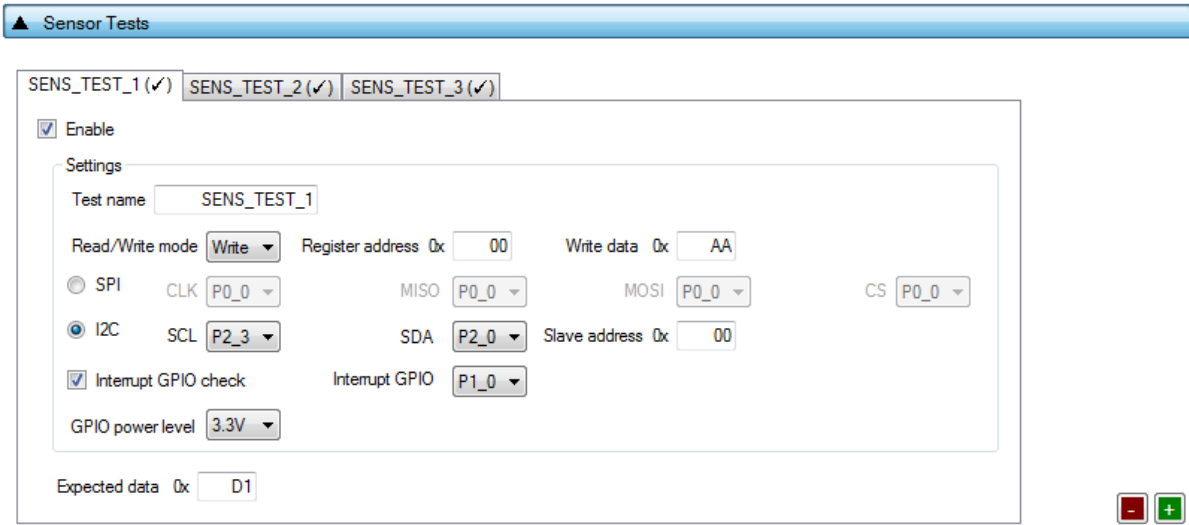

Figure 83: Sensor Test - DA1468x

Sensor Tests can have multiple instances with different settings. Tests can be added and removed using the two buttons (e.g. and in Figure 83) at the bottom right side of each panel.

**Note:** When adding or removing a test all settings are refreshed with the values written to the XML file, meaning that any unsaved settings will be lost.

Table 75 describes the available options for the Sensor Tests DA1468x Options.

Table 75: Sensor Tests - DA1468x

Option	Description
Enable	This option enables the specific sensor test.
Test name	The name assigned to each test. If this field is non-empty, then the assigned name will be shown on the tab and next to it an indication showing whether the specific test is enabled or not.
Read / Write mode	Select the sensor test procedure, to read or write.
Register address	The sensors register address to read or write data.
Write data	The byte to be written at the sensor register.
SPI / I2C	Select the interface that the sensor is connected to.
SPI - CLK	Select the GPIO for the sensor SPI CLK.
SPI - MISO	Select the GPIO for the sensor SPI MISO.
SPI - MOSI	Select the GPIO for the sensor SPI MOSI.
SPI - CS	Select the GPIO for the sensor SPI CS.
I2C - SCL	Select the GPIO for the sensor I2C SCL.
I2C - SDA	Select the GPIO for the sensor I2C SDA.
Slave address	The sensor I2C bus slave address.
Interrupt GPIO check	Enables the sensor interrupt signal test via GPIO.
Interrupt GPIO	Select the GPIO to be used as a sensor interrupt.
GPIO power level	Sets the power level of the GPIOs.

DA1458x/DA1468x Production Line Tool

Option	Description
Expected data	The received sensor byte that will be expected on a successful operation.

7.2.10.6 ADC Calibration (DA14681-00 AD only)

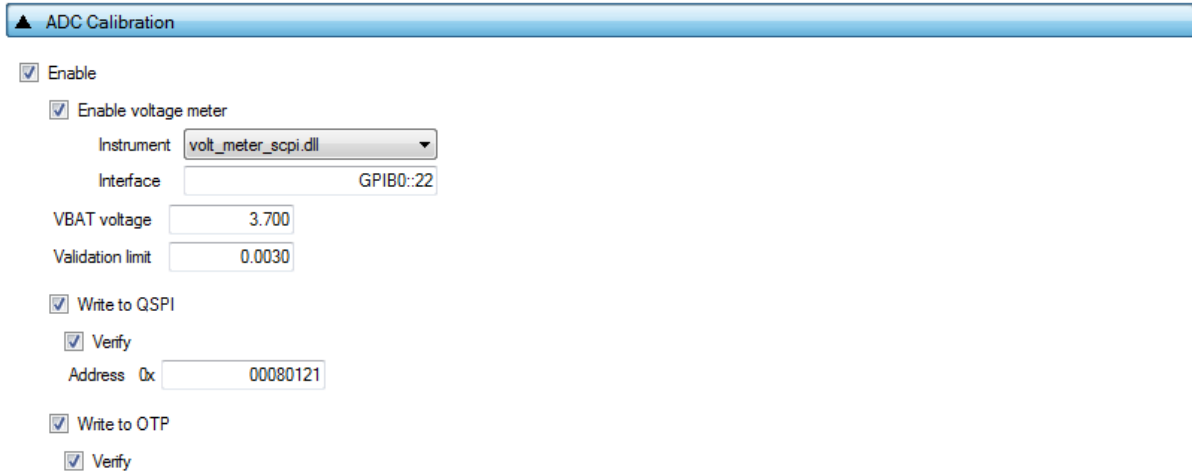

Figure 84: ADC Calibration - DA14681-00 (AD)

Table 76 describes the available options for the *ADC Calibration* operation available and necessary only for DA14681-00 based devices.

Table 76: ADC Calibration - DA14681-00 (AD)

Option	Description
Enable	Enable the ADC calibration procedure for DA14681-00 devices.
Enable voltage meter	Enable the use of a voltage meter instrument in the ADC calibration procedure.
Instrument	Select the voltage meter instrument DLL. Names are shown only if a voltage measurement instrument DLL exists in the project folder <code>volt_meter_instr_plugins</code> .
Interface	The interface of the instrument to be used by the driver.
VBAT Voltage	Set the external VBAT value in volts.
Validation limit	After the ADC calibration procedure finishes a validation procedure will be performed to verify the result. This value indicates the validation limit in volts.
Write to QSPI	Enable the writing of the ADC calibration value to QSPI Flash.
Write to QSPI - Verify	Verify the writing of the ADC calibration value to QSPI Flash.
Address	The QSPI Flash address where the ADC calibration value will be burned.
Write to OTP	Enable the writing of the ADC calibration value to OTP.
Write to OTP - Verify	Verify the writing of the ADC calibration value to OTP.

DA1458x/DA1468x Production Line Tool

7.2.10.7 Custom Test

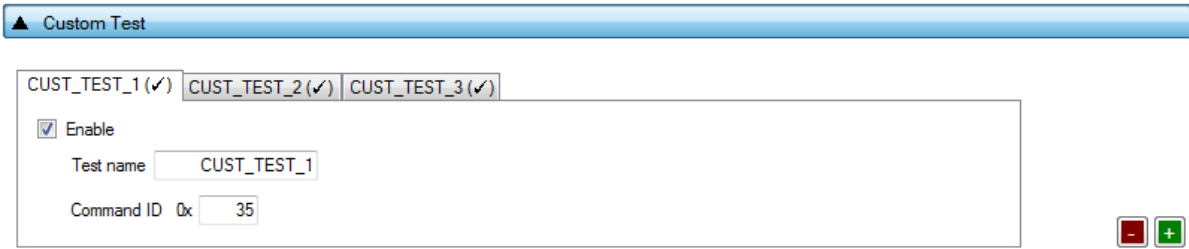

Figure 85: Custom Test - DA1468x

Custom tests can have multiple instances with different settings. Tests can be added and removed using the two buttons (e.g. and in Figure 85) at the bottom right side of each panel.

**Note:** When adding or removing a test all settings are refreshed with the values written to the XML file, meaning that any unsaved settings will be lost.

Table 77 describes the available options for the DA1468x Custom Tests.

When enabled, the PLT software will send an HCI command through UART to activate a customer defined test that will run on the DUTs. The HCI custom test command will contain a single byte as data (the Command ID byte), to be used mainly as identification for a specific test in the firmware. Default functionality of the production test firmware is to respond with the same Command ID. Otherwise the test will be considered as failed.

Table 77: Custom Tests DA1468x Options

Option	Description
Enable	This option enables the specific custom test.
Test name	The name assigned to each test. If this field is non-empty, then the assigned name will be shown on the tab and next to it an indication showing whether the specific test is enabled or not.
Command ID	The byte that will be sent to the device running the production test firmware.

7.2.10.8 Temperature Measurement Test

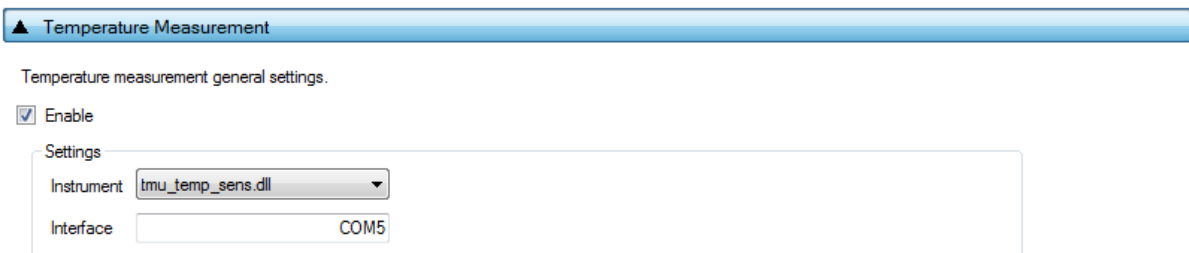

Figure 86: Temperature Measurement Test - DA1468x

Table 78 describes the available options for the DA1468x Temperature Measurement Test.

Table 78: Temperature Measurement Test - DA1468x

Option	Description
Enable	This option enables the Temperature measurement test.
Instrument	Select the Temperature measurement DLL. Names are shown only if a Temperature measurement instrument DLL exists in the project folder temp_meas_instr_plugins.

DA1458x/DA1468x Production Line Tool

Option	Description
Interface	The interface of the instrument to be used by the driver.

7.2.10.9 Scan Test

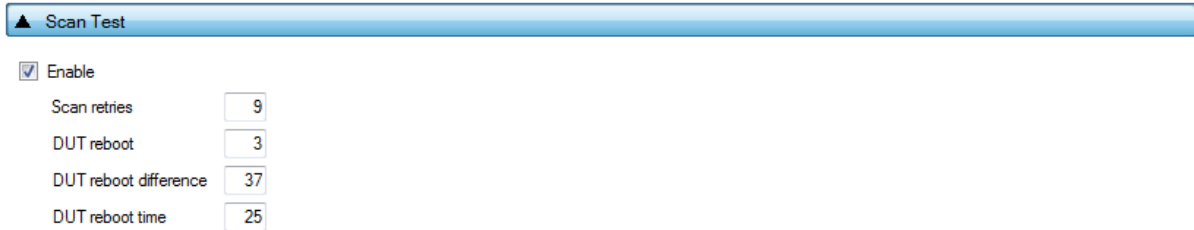

Figure 87: Scan Test - DA1468x

Table 79 describes the available options for the DA1468x Scan Test.

By enabling this test, the Golden Unit will scan for the DUT’s BD addresses advertised after the customer firmware has been burned. For this test to work, a bootable firmware with the ability to advertise with the BD address given by the PLT must be burned into each DUT. Additionally, the BD addresses provided by the PLT should be burned into OTP memory such that the devices advertise with the BD addresses the tool uses.

Table 79: Scan Test DA1468x Options

Option	Description
Enable	This option enables the Scan test.
Scan retries	The total number of BLE advertising scans the Golden Unit will perform.
DUT reboot	Define after how many retries the PLT will reboot the DUTs.
DUT reboot difference	Set the time difference between each DUT when the PLT reboots the devices, in order to avoid air collisions.
DUT reboot time	The time the VBAT will remain low during the device reboot. This value is time in ms*100. (e.g. 15 is 1500ms).

DA1458x/DA1468x Production Line Tool

7.2.11 Memory Functions (DA1468x)

This section describes the Memory Functions settings available when using DA1468x devices. Memory functions include OTP and QSPI Flash memory programming.

7.2.11.1 OTP Memory

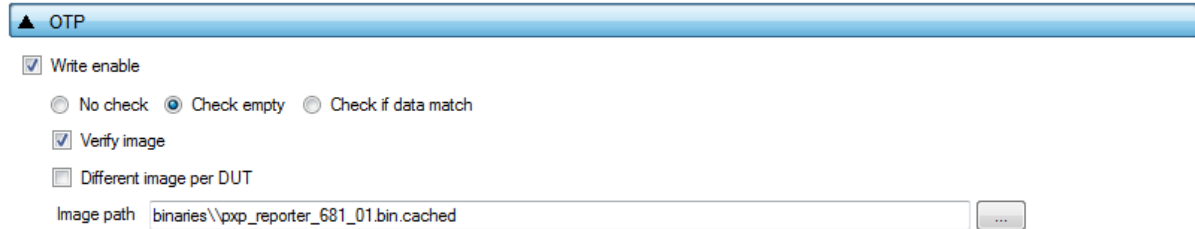

Figure 88: OTP Memory - DA1468x

This test enables the OTP memory programming. Table 80 describes the available options for the *OTP Memory* image write operation.

Table 80: OTP Memory - DA1468x

Option	Description
Write enable	This option enables the OTP image write operation.
<ul style="list-style-type: none"> <li>No check</li> <li>Check empty</li> <li>Check if data match</li> </ul>	<p>Memory protection options:</p> <p><b>No check:</b> No protection is enabled. PLT will attempt to burn the OTP memory without running any check.</p> <p><b>Check empty:</b> PLT will first check if the OTP memory to be burned is empty, and if it is it will then proceed to burn it.</p> <p><b>Check if data match:</b> PLT will first check if the memory to be burned is empty. If it is not then it will compare its contents with the data to be burned. If the data are not the same the test will fail without making any change to the memory. If the data are the same, PLT will not perform any burning to the memory to prevent using the OTP repair memory for these devices.</p>
Verify image	If this option is enabled, the PLT reads back the contents of the OTP memory and compares them to the original image file. If these do not match, the OTP memory programming will fail.
Different image per DUT	If this option is selected, a different image per DUT can be burned into the OTP. The image name must be specific for each DUT, as described below.
Image path	<p>Via this field the user specifies the image file to be burned into the OTP. A .bin binary file of any name can be selected.</p> <p>If option <i>Different image per DUT</i> is selected, the user only selects the directory of the images. In that case the binary file names must have the following format: <i>img_0X.bin</i>, where 'X' denotes the DUT number. For example, if the user has activated DUTs 1, 5 and 10 then <i>img_01.img</i>, <i>img_05.img</i> and <i>img_10.img</i> binary files should exist in the selected OTP image path, as shown in Figure 64.</p>

7.2.11.2 QSPI Flash Memory

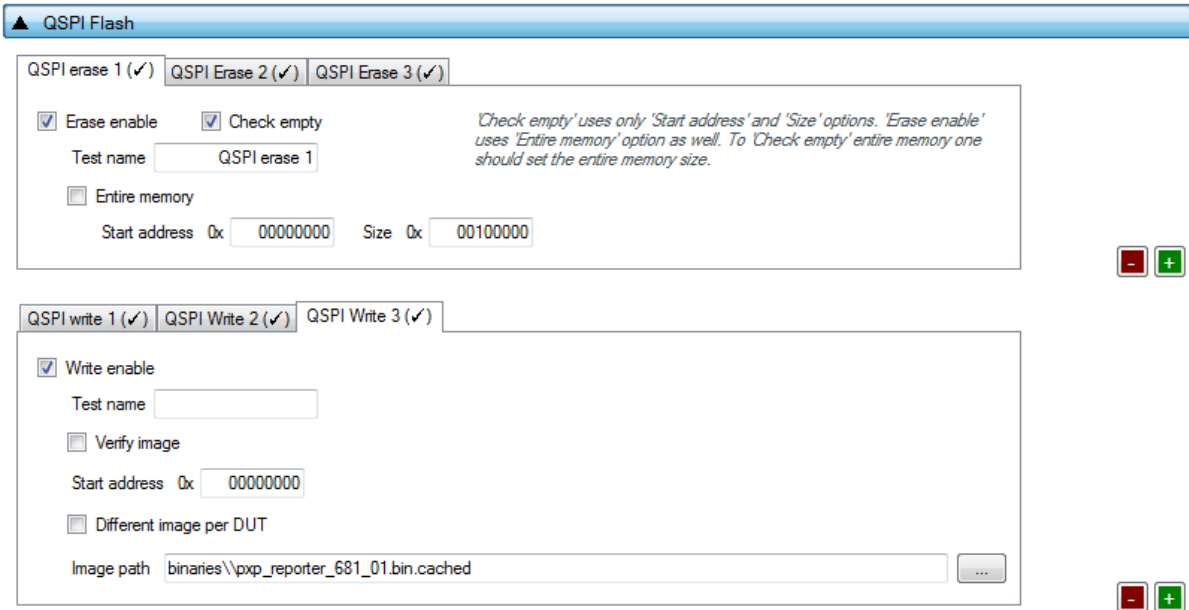

Figure 89: QSPI Flash - DA1468x

This section describes how the QSPI Flash memory can be erased and programmed.

Both erase and write operations can have multiple instances with different settings. Tests can be added and removed using the two buttons (e.g. and in Figure 89) at the bottom right side of each panel.

**Note:** When adding or removing a test all settings are refreshed with the values written to the XML file, meaning that any unsaved settings will be lost.

The QSPI Flash memory should be erased before any image is written to it. Table 81 describes the available options for the *QSPI Flash Erase* operation.

Table 81: QSPI Flash Erase - DA1468x

Option	Description
Erase enable	This will enable the specific QSPI Flash erase test.
Check empty	After Flash erasure the PLT software can verify the result by sending a specific command to the <code>uartboot.bin</code> firmware running in the DUT. The firmware will read the QSPI Flash and check if it is empty. The result will be returned to the PLT software.
Entire memory	This option is only available for the <i>Erase enable</i> option. When this checkbox is selected, the entire memory can be erased. Otherwise the user can give a start address and a specific number of bytes to be erased.
Start address	The user can enter a specific start address for the QSPI erasure to start.
Size	The size in bytes to erase, starting from the <i>Start address</i> as explained above.

After every *QSPI Flash erase* test has finished, the *QSPI image write* tests will begin. Table 82 describes the available options for the *QSPI Flash Image Write* operation.

Table 82: QSPI Flash Image Write - DA1468x

Option	Description
Write enable	This will enable the specific QSPI Flash image programming test.

DA1458x/DA1468x Production Line Tool

Option	Description
Verify image	By selecting this option the PLT software will read back the contents of the QSPI Flash memory and compare them to the original image file. If these do not match, the QSPI memory programming will fail.
Start address	The user can configure the QSPI Flash start address where the image will be written.
Different image per DUT	If this option is selected, ten a different image per DUT can be burned into the QSPI Flash. The image name must be specific for each DUT, as described below.
Image path	Via this field the user specifies the image file to be burned into the QSPI Flash memory. A .bin binary file of any name can be selected.  If option <i>Different image per DUT</i> is selected, the user only specifies the directory of the images. In that case the binary file names must have the following format: <i>img_0X.bin</i> , where 'X' denotes the DUT number. For example, if the user has activated DUTs 1, 5 and 10 then <i>img_01.img</i> , <i>img_05.img</i> and <i>img_10.img</i> binary files should exist in the selected QSPI image path, as shown in <a href="#">Figure 64</a> .

7.2.11.3 Memory read

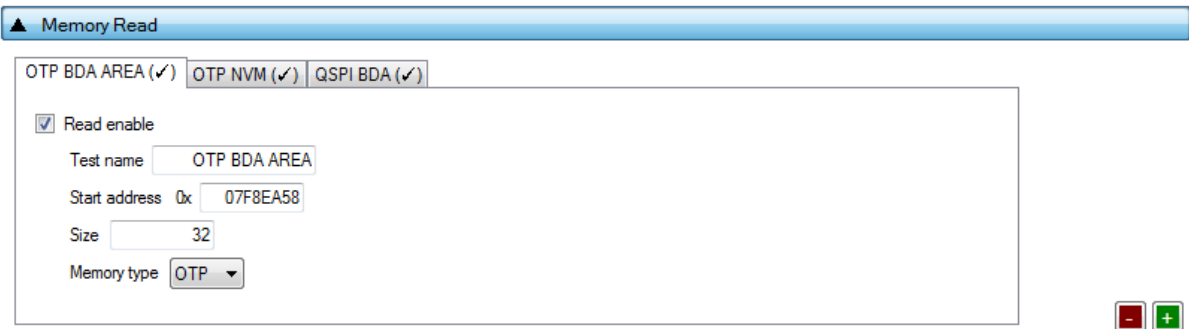

Figure 90: Memory Read Test - DA1468x

Table 83: Memory Read Test - DA1468x

Option	Description
Read enable	This will enable the specific memory reading test.
Test name	The name assigned to each test. If this field is non-empty, then the assigned name will be shown on the tab and next to it an indication showing whether the specific test is enabled or not.
Start address	Configures the Start address for the read test. OTP valid address is 0x07F80000 – 0x7F8FFFF.
Size	Number of bytes to read, up to 256 bytes.
Memory type	The type of memory to read the data from. Available options are: OTP and QSPI FLASH.

7.2.12 Memory Header (DA1468x)

This section describes the Memory Header programming settings (OTP and QSPI), available when using DA1468x devices.



DA1458x/DA1468x Production Line Tool

7.2.12.1 OTP Header

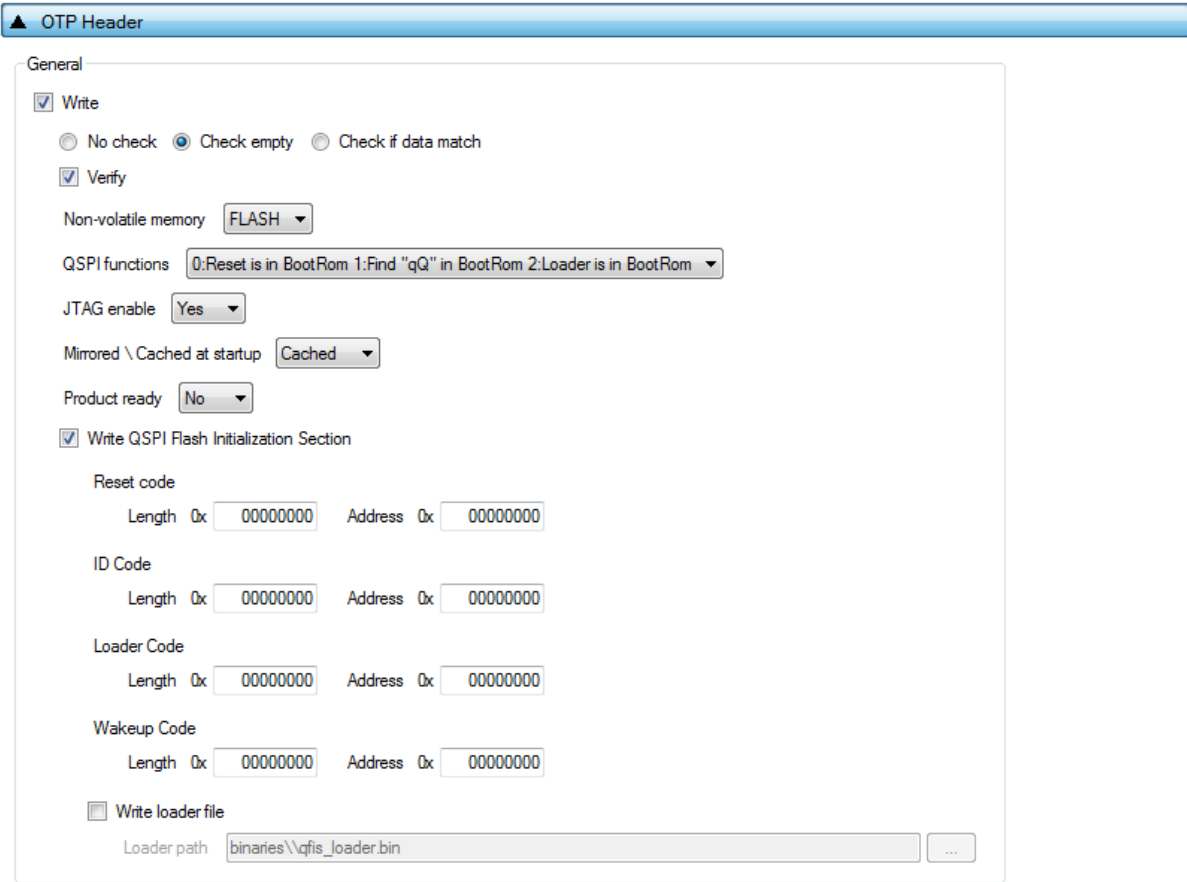

Figure 91: OTP Header - DA1468x

Table 84 describes the available options for the DA1468x *OTP Header* programming.

Table 84: General - OTP Header DA1468x Options

Option	Description
Write OTP Header	This option enables the OTP header programming.
<ul style="list-style-type: none"> <li>No check</li> <li>Check empty</li> <li>Check if data match</li> </ul>	<p>Memory protection options:</p> <p><b>No check:</b> No protection is enabled. PLT will attempt to burn the OTP memory without running any check.</p> <p><b>Check empty:</b> PLT will first check if the OTP memory to be burned is empty, and if it is it will then proceed to burn it.</p> <p><b>Check if data match:</b> PLT will first check if the memory to be burned is empty. If it is not then it will compare its contents with the data to be burned. If the data are not the same the test will fail without making any change to the memory. If the data are the same, PLT will not perform any burning to the memory to prevent using the OTP repair memory for these devices.</p>
Verify OTP Header	Each value written in the OTP header can be read back and compared with the original ones to verify a successful write.
Non-volatile memory	<p>Enable OTP NVM mode. Available options are:</p> <ul style="list-style-type: none"> <li>FLASH</li> <li>OTP</li> </ul>

DA1458x/DA1468x Production Line Tool

Option	Description
QSPI Functions	Select the QSPI functions. Available options are: <ul style="list-style-type: none"> <li>● 0: Reset is in BootRom, 1: Find "qQ" in BootRom, 2: Loader is in BootRom</li> <li>● 0: Reset is in OTP, 1: Find "qQ" in BootRom, 2: Loader is in BootRom</li> <li>● 0: Reset is in BootRom, 1: Find "qQ" in OTP, 2: Loader is in BootRom</li> <li>● 0: Reset is in OTP, 1: Find "qQ" in OTP, 2: Loader is in BootRom</li> <li>● 0: Reset is in BootRom, 1: Find "qQ" in BootRom, 2: Loader is in OTP</li> <li>● 0: Reset is in OTP, 1: Find "qQ" in BootRom, 2: Loader is in OTP</li> <li>● 0: Reset is in BootRom, 1: Find "qQ" in OTP, 2: Loader is in OTP</li> <li>● 0: Reset is in OTP, 1: Find "qQ" in OTP, 2: Loader is in OTP</li> </ul>
JTAG enable	Enable the JTAG support.
Mirrored/Cached at startup	Enable OTP cached mode. Available options are: <ul style="list-style-type: none"> <li>● Mirrored</li> <li>● Cached</li> </ul>
Product ready	When this flag is set the device will boot from the NVM selected (OTP or QSPI Flash). Should be used for a production ready device. If enabled, it will not be able to access the device again other than via JTAG, if this option is still enabled in the OTP header.
Write QSPI Flash Initialization Section	Enable the QSPI Flash Initialization Section.
Reset Code	The OTP header data for the QSPI reset code.
ID Code	The OTP header data for the QSPI "qQ" identification code.
Loader Code	The OTP header for the QSPI loader code.
Wakeup Code	The OTP header for the QSPI wakeup code.
Write loader file	Enable the writing of the loader file for the QSPI Flash Initialization Section.
Loader path	The file containing the data that will be burned in the QFIS loader.

7.2.12.2 OTP Header - BD Address

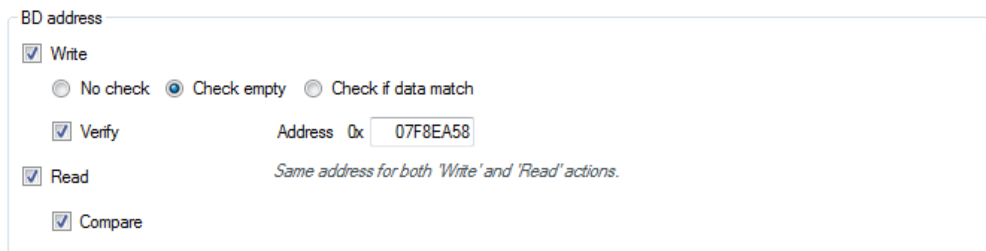

Figure 92: OTP Header BD Address - DA1468x

Table 85 describes the available options for the DA1468x BD Address programming.

Table 85: OTP Header BD Address - DA1468x

Option	Description
Write	Enable burning the BD address into the device OTP header.

DA1458x/DA1468x Production Line Tool

Option	Description
<ul style="list-style-type: none"> <li>No check</li> <li>Check empty</li> <li>Check if data match</li> </ul>	<p>Memory protection options:</p> <p><b>No check:</b> No protection is enabled. PLT will attempt to burn the OTP memory without running any check.</p> <p><b>Check empty:</b> PLT will first check if the OTP memory to be burned is empty, and if it is it will then proceed to burn it.</p> <p><b>Check if data match:</b> PLT will first check if the memory to be burned is empty. If it is not then it will compare its contents with the data to be burned. If the data are not the same the test will fail without making any change to the memory. If the data are the same, PLT will not perform any burning to the memory to prevent using the OTP repair memory for these devices.</p>
Verify	When enabled, the PLT will read back the BD address burned into the OTP header and compare it to the one provided by the PLT.
Read	This will read the BD address written in the OTP Header field. It does not depend on the previous tests to run, but it is necessary for the following <i>Compare</i> test.
Compare	When the <i>Read</i> option is enabled, a comparison will be performed between the read BD address and the BD address entered in the DUT by the PLT, as described in the BD address DUT assignment method.
Address	The OTP address where the BD address will be written. This field is the same for all of the above actions. Default value is 0x07F8EA58. OTP valid address is 0x07F80000 – 0x7F8FFFF.

7.2.12.3 OTP Header - XTAL Trim

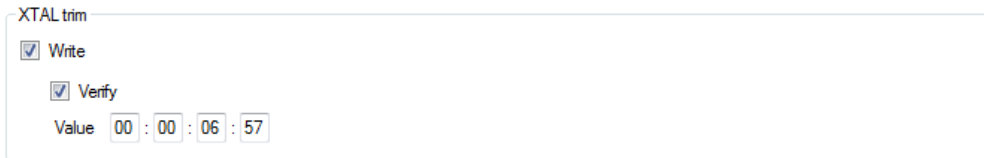

Figure 93: OTP Header XTAL Trim - DA1468x

Table 86 describes the available options for the DA1468x *OTP Header XTAL Trim* programming operation.

Table 86: OTP Header XTAL Trim - DA1468x

Option	Description
Write	Enable burning the BD address into the device OTP header.
Verify	When enabled, the PLT will read back the BD address burned into the OTP header and compare it to the one provided by the PLT.
Value	Crystal oscillator calibration value common to all devices. Can be burned only if the automatic crystal burn calibration operation for the OTP memory in <i>XTAL Trim</i> is disabled.

DA1458x/DA1468x Production Line Tool

7.2.12.4 QSPI Header - BD Address

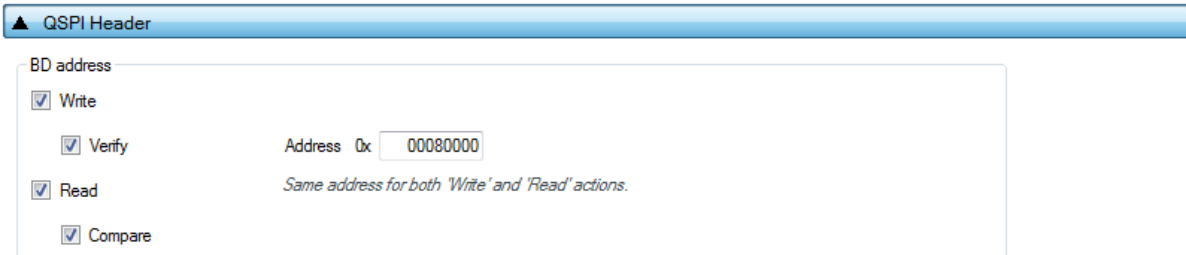

Figure 94: QSPI Header BD Address - DA1468x

Table 87 describes the available options for the DA1468x *BD Address* programming operation into the QSPI Header.

Table 87: QSPI Header BD Address - DA1468x

Option	Description
Write	When selected the BD address will be written in the QSPI Header.
Verify	If selected, the BD address will be read back from the QSPI Header and will be compared to the original.
Read	This option will read the BD address written in the QSPI Header field. It does not depend on the previous tests to run, but it is necessary for the following <i>Compare</i> test.
Compare	When the <i>Read</i> option is enabled, a comparison will be performed between the read BD address and the BD address entered in the DUT by the PLT, as described in the BD address DUT assignment method.
Address	The QSPI Flash address where the BD address will be written. This field is the same for all of the above actions. Default value is 0x080000.

7.2.12.5 QSPI Header - XTAL Trim

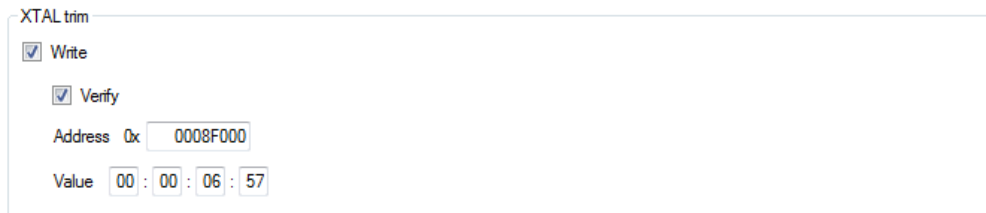

Figure 95: QSPI Header XTAL Trim

Table 88 describes the available options for the *XTAL Trim* programming into the QSPI Header.

Table 88: QSPI Header XTAL Trim

Option	Description
Write	Enable burning a crystal oscillator calibration value, common to all devices.
Verify	When enabled, the crystal oscillator calibration value will be read back from the QSPI Flash and compared to the one the user has supplied.
Address	The QSPI Flash address where the crystal oscillator calibration value will be burned. Default value is 0x08F000.
Value	Crystal oscillator calibration value common to all devices. Can be burned only if the automatic crystal burn calibration operation for the QSPI memory in <i>XTAL Trim</i> is disabled.

DA1458x/DA1468x Production Line Tool

7.2.12.6 Custom Memory Data

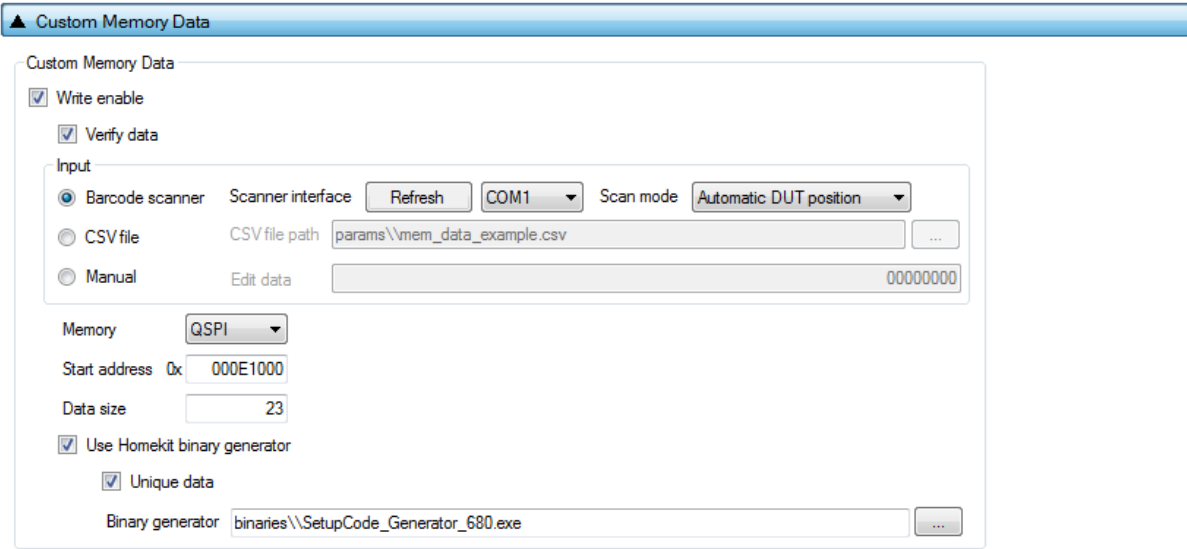

Figure 96: Custom Memory Data - DA1468x

Table 89: Custom Memory Data - DA1468x

Option	Description								
Write enable	This option enables the Custom data programming.								
Verify data	When selected, the data written will be read back from the memory and will be compared to the original.								
<ul style="list-style-type: none"> <li>Barcode scanner</li> <li>CSV file</li> <li>Manual data</li> </ul>	<p>Custom data input options:</p> <table border="1"> <tr> <td>Scanner interface (Barcode scanner)</td> <td> <p>Selection of the barcode scanner COM port from a dropdown list with all the available system COM ports.</p> <p>A common USB to UART barcode scanner is supported. PLT has been tested with Honeywell Xenon 1900. <a href="#">Appendix K</a> describes the setup procedure.</p> <p><b>This option is the exact same option as in Scan Mode and the DA1458x devices in Custom Memory Data.</b></p> </td> </tr> <tr> <td>Scan mode (Barcode scanner)</td> <td> <p><b>Scan DUT position:</b> In this mode the users must first scan the DUT position number and then the BD address. The string used for the position of each DUT is "TEST POSITION 0xx" where "xx" is the DUT position number.</p> <p><b>Automatic DUT position:</b> Scanned BD address will be assigned to the selected DUT. The DUT selection is automatically been made, starting from the first active DUT and selecting the next one after a successful BD address scan. Users can change the selected DUT using the controls on the GUI PLT screen shown in <a href="#">Figure 102</a>.</p> <p><b>This option is the exact same option as in Scan Mode and the DA1458x devices in Custom Memory Data.</b></p> </td> </tr> <tr> <td>CSV file path (CSV file)</td> <td>Path to the CSV file containing data for each device discriminated using BD addresses. The CSV file format is described in <a href="#">Custom data CSV file format</a>.</td> </tr> <tr> <td>Edit data (Manual data)</td> <td>Hexadecimal data input of up to 256 bytes to burn. These data will be burned to all active DUTs.</td> </tr> </table>	Scanner interface (Barcode scanner)	<p>Selection of the barcode scanner COM port from a dropdown list with all the available system COM ports.</p> <p>A common USB to UART barcode scanner is supported. PLT has been tested with Honeywell Xenon 1900. <a href="#">Appendix K</a> describes the setup procedure.</p> <p><b>This option is the exact same option as in Scan Mode and the DA1458x devices in Custom Memory Data.</b></p>	Scan mode (Barcode scanner)	<p><b>Scan DUT position:</b> In this mode the users must first scan the DUT position number and then the BD address. The string used for the position of each DUT is "TEST POSITION 0xx" where "xx" is the DUT position number.</p> <p><b>Automatic DUT position:</b> Scanned BD address will be assigned to the selected DUT. The DUT selection is automatically been made, starting from the first active DUT and selecting the next one after a successful BD address scan. Users can change the selected DUT using the controls on the GUI PLT screen shown in <a href="#">Figure 102</a>.</p> <p><b>This option is the exact same option as in Scan Mode and the DA1458x devices in Custom Memory Data.</b></p>	CSV file path (CSV file)	Path to the CSV file containing data for each device discriminated using BD addresses. The CSV file format is described in <a href="#">Custom data CSV file format</a> .	Edit data (Manual data)	Hexadecimal data input of up to 256 bytes to burn. These data will be burned to all active DUTs.
Scanner interface (Barcode scanner)	<p>Selection of the barcode scanner COM port from a dropdown list with all the available system COM ports.</p> <p>A common USB to UART barcode scanner is supported. PLT has been tested with Honeywell Xenon 1900. <a href="#">Appendix K</a> describes the setup procedure.</p> <p><b>This option is the exact same option as in Scan Mode and the DA1458x devices in Custom Memory Data.</b></p>								
Scan mode (Barcode scanner)	<p><b>Scan DUT position:</b> In this mode the users must first scan the DUT position number and then the BD address. The string used for the position of each DUT is "TEST POSITION 0xx" where "xx" is the DUT position number.</p> <p><b>Automatic DUT position:</b> Scanned BD address will be assigned to the selected DUT. The DUT selection is automatically been made, starting from the first active DUT and selecting the next one after a successful BD address scan. Users can change the selected DUT using the controls on the GUI PLT screen shown in <a href="#">Figure 102</a>.</p> <p><b>This option is the exact same option as in Scan Mode and the DA1458x devices in Custom Memory Data.</b></p>								
CSV file path (CSV file)	Path to the CSV file containing data for each device discriminated using BD addresses. The CSV file format is described in <a href="#">Custom data CSV file format</a> .								
Edit data (Manual data)	Hexadecimal data input of up to 256 bytes to burn. These data will be burned to all active DUTs.								

DA1458x/DA1468x Production Line Tool

Option	Description
Memory (available with Barcode scanner and Manual data modes)	Memory type selection to burn the data. Available options are OTP and QSPI.
Start address (available with Barcode scanner and Manual data modes)	Memory address offset to begin burning the data. OTP valid address is 0x07F80000 – 0x7F8FFFFF.
Data size (available with Barcode scanner and Manual data modes)	The size of the memory data to burn. In barcode scanner, the data size is the number of scanned ASCII characters. In manual data, data size is the number of bytes. If the Homekit binary generator is used, the data size entered here is the size of the setup code and serial number as explained in Table 16. In the example the data to be scanned are “12345678DIAG97969594P”, meaning that the data size should be 21 since ASCII character will be scanned. The data size to be actually burned into the devices will be 574 bytes, which is the binary size created by the SetupCode_Generator_680.exe application.
Use Homekit binary generator (available with Barcode scanner mode)	If enabled the input memory data from the barcode scanner will be applied as input to the Dialog Homekit setup code binary generator. PLT will automatically call the setup code binary generator and burn the files created.
Unique data (available with Barcode scanner mode)	If enabled the input memory data will be compared to each other and if same data are found an error will be issued. Comparison can only be performed per current PLT test run and not for previous tested devices.
Binary generator (available with Barcode scanner mode)	The path to the Homekit setup code binary generator executable. PLT will automatically call this application and burn the files created.

7.2.13 Debug Settings

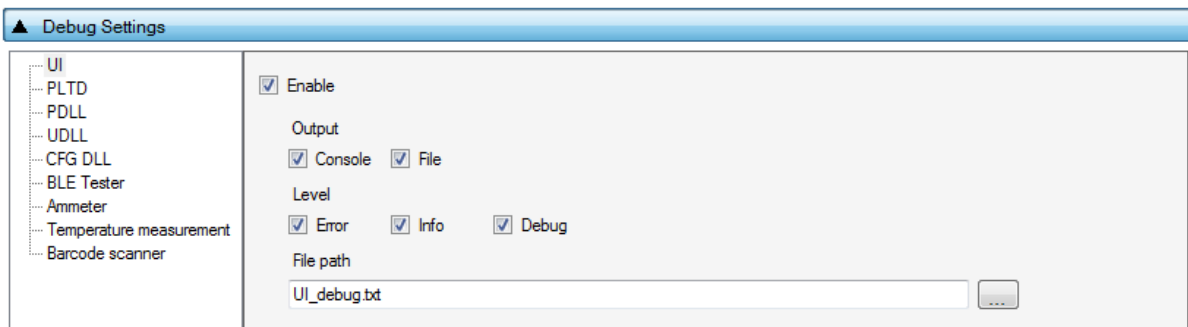

Figure 97: Debug Settings

Table 90 describes the available options for the *Debug Settings*. Debug messages are available in all PLT software blocks shown in Figure 20.

**Note:** Printing debug information may introduce system delay and thus some tests may fail due to time out expirations. We suggest having debug information disabled in all software blocks and only partially enable when there is a real need for it. From PLT v4.0 and onwards, this system delay has been almost eliminated as debug print messages are printed from a lower priority queue. It is safer, but it is still suggested to have the debug prints disabled.

DA1458x/DA1468x Production Line Tool

Table 90: Debug Settings

Option	Description
Enable	Enable debug message prints for the selected library or UI.
Output - Console	Sends the debug messages to the <code>stdio</code> output. The PLT CLI does not support this option. If enabled, debug messages will be redirected to the equivalent files.
Output - File	Save the debug messages to a file.
Level - Error	Enable <code>error</code> debug level messages. All debug print messages marked as <code>error</code> will be printed.
Level - Info	Enable <code>info</code> debug level messages. All debug print messages marked as <code>info</code> will be printed.
Level - Debug	Enable <code>low level</code> debug level messages. All <code>low level</code> debug print messages will be printed.
File path	Select the file that the debug messages will be saved. The file should exist, otherwise it should be created manually. Used only when the option <code>Output - File</code> is selected.

7.2.14 Security

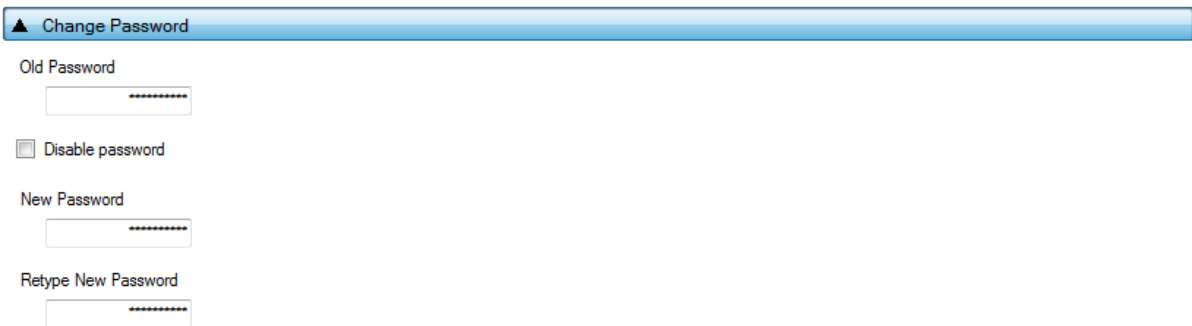

Figure 98: Security

In this field a password can be set to protect specific tool actions, such as:

- Opening the CFG PLT or the GUI PLT application.
- Closing the CFG PLT or the GUI PLT application.
- Opening or refreshing configuration settings in the GUI PLT application.
- Opening the settings menu in the GUI PLT application.

Table 91 describes the available options for the *Security Options*.

Table 91: Security Options

Option	Description
Old Password	Type the current password to enable changing of the following fields.
Disable Password	This option will disable the password usage.
New Password	Type a new password.
Retype New Password	Verify the new password.

7.3 GUI PLT Application

The GUI PLT (`DA1458x_DA1468x_GUI_PLT.exe`) is a Graphical User Interface application that performs the device validation and programming process. At the same time it allows the users to



DA1458x/DA1468x Production Line Tool

monitor the entire procedure in detail. The GUI PLT uses the same XML file configured from CFG PLT as described in section 7.2.

**Note:** If a change is made to the XML file from the CFG PLT, then the GUI PLT settings should be refreshed as described in Table 92.

Figure 99 shows the initial screen of the GUI PLT, which is described in Table 92.

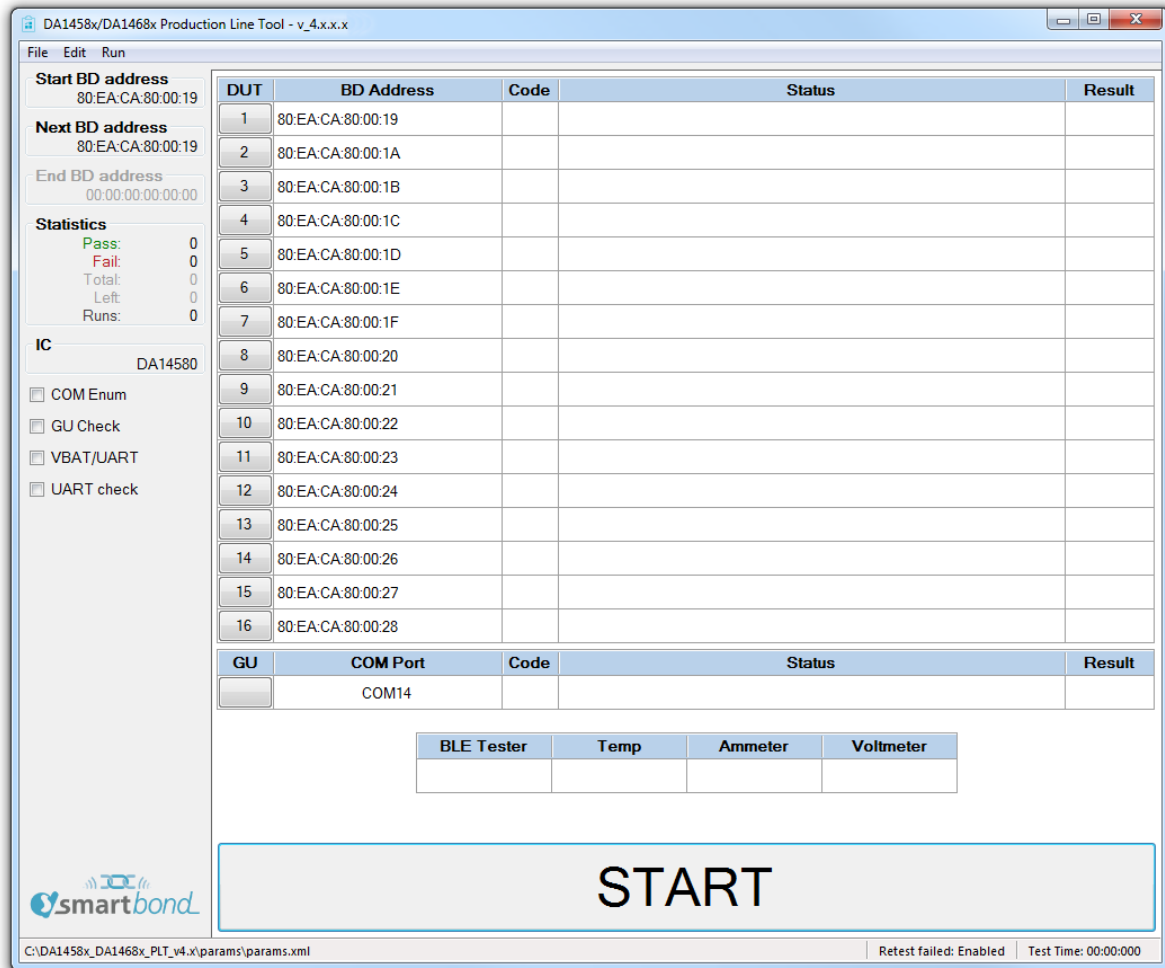

Figure 99: GUI PLT Main Screen

Table 92: GUI PLT Main Screen Description

Options	Description
<b>File options</b>	
File > Open XML file	Opens a new XML file and loads its settings. The full path of the new XML file is shown at the bottom end of the screen.
File > Refresh XML file	Reloads the settings from the XML file and initializes itself with the new settings.
File > Open CSV file	Contains a list with all the available CSV files to open.
File > Exit	Exits the GUI PLT application.
<b>Edit options</b>	
Edit > Settings	Opens the <a href="#">GUI PLT Settings</a> window.

DA1458x/DA1468x Production Line Tool

Options	Description
<b>Run options</b>	
Run > Run Configuration PLT	Opens the CFG PLT application.
<b>Left Column options</b>	
Start BD Address	The BD address the PLT session started with, as described in section 7.2.4.
Next BD Address	The BD address that will be used on the BD address assignment for the next run as described in section 7.2.4.
End BD Address	The BD address the PLT session ends with as described in section 7.2.4. This option is available only when <i>Range mode</i> is enabled.
Statistics	This field holds statistics for each PLT session. Table 27 describes the <i>Statistics</i> field.
IC	The selected IC of the PLT.
COM Enum	If this checkbox is enabled then the START button initiates the automatic Window COM port enumeration for the DUT.
GU Check	If this checkbox is enabled then the START button initiates the automatic Window COM port enumeration for the Golden Unit.
VBAT/UART	If this checkbox is enabled then the START button will enable the VBAT and UART for the DUTs selected under <i>VBAT/UART</i> in Table 93.
UART check	If this checkbox is enabled then the START button initiates the UART check procedure for the DUTs with a specified Baud rate set from the user through the <i>GUI PLT Settings</i> . During this test 1000 packets will be sent, received back and checked for errors. For the DA14580/1/2/3 and DA1468x DUTs the packets contain 252 bytes and for the DA1585/6 DUTs 100 bytes of data. <b>Note:</b> Before any UART transfer begins PLT will download the production test firmware to the active DUTs.
<b>Center screen options</b>	
DUT panel	Shows the following fields for each DUT: <ul style="list-style-type: none"> <li>• <b>DUT:</b> DUT connector number on the PLT hardware. This field is also a button which opens the Log file for the specific DUT.</li> <li>• <b>BD Address:</b> BD address assigned to the DUT.</li> <li>• <b>Code:</b> Real-time status as a PLTD DLL special code described in [1].</li> <li>• <b>Description:</b> A brief description of the status code.</li> <li>• <b>Result:</b> Simplified color coded status showing the progress per DUT.</li> </ul>
GU panel	Shows the following fields for the Golden Unit: <ul style="list-style-type: none"> <li>• <b>GU:</b> A button which opens the Golden Unit Log file.</li> <li>• <b>COM Port:</b> The COM port assigned to the Golden Unit.</li> <li>• <b>Code:</b> Real-time status as a PLTD DLL special code described in [1].</li> <li>• <b>Status:</b> A brief description of the status code.</li> <li>• <b>Result:</b> Simplified color coded status showing the progress of the GU.</li> </ul>
Instrument panel	This field shows a simplified color coded status is shown for each of the instruments ( <b>BLE Tester</b> , <b>Temp</b> , <b>Ammeter</b> and <b>Voltmeter</b> ), if they are enabled.
START button	If one of the options <i>COM Enum</i> , <i>GU Check</i> , <i>VBAT/UART</i> or <i>UART check</i> is enabled, then pressing the <i>START</i> button will initiate the chosen test. If no option is selected, pressing the <i>START</i> button initiates the production procedure.
<b>Bottom of the main screen</b>	
Left panel: C:\Release\params\params.xml	Shows the full path of the XML file that is currently used.

DA1458x/DA1468x Production Line Tool

Options	Description
Center panel: Retest failed: Disabled	Shows if the Re-test option in <a href="#">GUI PLT Settings</a> is enabled.
Right panel: Test Time: 00:00:000	This timer starts counting when the START button is pressed and runs until the PLT returns to its idle state, showing the approximate duration of the tests.

7.3.1 GUI PLT Settings

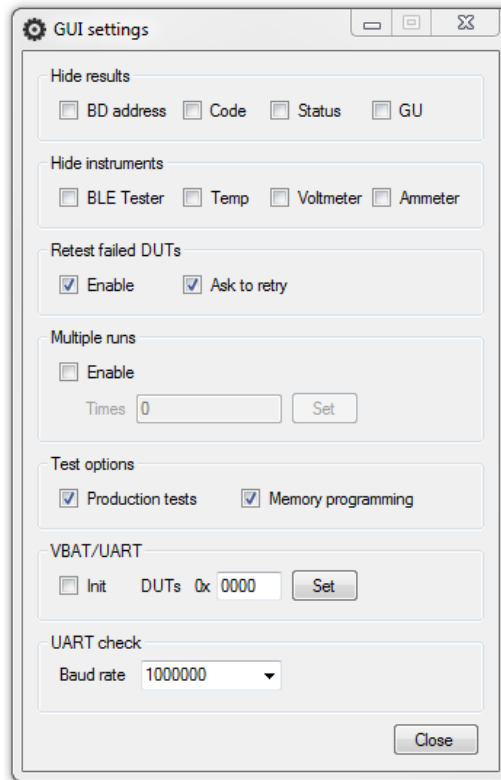

Figure 100: GUI PLT Settings

Figure 100 shows the *GUI PLT settings* window. In this window various graphic options and features can be set as described in [Table 93](#).

Table 93: GUI PLT Settings

Field	Option	Description
Hide results	BD address	This option will hide the <i>BD address</i> column in the DUT panel of the GUI PLT.
	Code	This option will hide the <i>Code</i> column in the DUT panel of the GUI PLT.
	Status	This option will hide the <i>Status</i> column in the DUT panel of the GUI PLT.
	GU	This option will hide the <i>GU</i> column in the DUT panel of the GUI PLT.
Hide instruments	BLE Tester	This option will hide the <i>BLE Tester</i> column in the GU panel of the GUI PLT.
	Temp	This option will hide the <i>Temp</i> column in the GU panel of the GUI PLT.

DA1458x/DA1468x Production Line Tool

Field	Option	Description
	Voltmeter	This option will hide the <i>Voltmeter</i> column in the GU panel of the GUI PLT.
	Ammeter	This option will hide the <i>Ammeter</i> column in the GU panel of the GUI PLT.
Retest failed DUTs	Enable	If this option is enabled, any DUT that failed during the main procedure will immediately re-run the tests having the exact same options including the <i>BD address</i> assigned to it. This option is the exact same option as <i>Re-test failed DUTs</i> in section 7.2.3.2.
	Ask to retry	This option will show a message asking to do a re-test in case any DUT failed. If this option is disabled, the re-testing will be done automatically.
Multiple Runs	Enable	By enabling this option the GUI PLT will perform multiple procedures without any delay between them. This is used for only for evaluation.
	Times	The number of times to run.
Test Options	Production tests	Enables /Disables the production test procedure. This is the same option as <i>Production tests</i> in section 7.2.3.2.
	Memory programming	Enables /Disables the production test procedure. This is the same option as <i>Memory programming</i> in section 7.2.3.2.
VBAT/UART	Init	If this option is enabled, the PLT hardware will be reset before enabling the DUTs. This option is enabled only when <i>VBAT/UART</i> in the main screen is enabled.
	DUTs	Bitwise DUT set/reset for each of the 16 DUTs using a 16-bit hexadecimal value. 089 <b>Example:</b> To enable only DUTs 1, 2, 15 and 16 use "C003" (1100 0000 0000 0011 = 0xC003).
UART check	Baud rate	Sets the Baud rate for the UART check test.

7.3.2 Barcode Scanner Mode

A barcode scanner can be used for two purposes. It can be used to scan DUT BD addresses and/or Custom Memory Data. If any these options have the Barcode scanner option enabled then the Barcode Scan option will appear in the GUI PLT as shown in Figure 101. If both options are enabled then the GUI PLT will first use the Barcode scanner for the BD address Scan Mode assignment and then for the Custom Memory Data.

In all cases described in section 7.2.4.1 except Scan Mode, the GUI PLT assigns BD addresses right before the PLT starts the production test run. Device BD addresses should be scanned before the start of a production test run. If the START button is pressed without any BD address being assigned to the device, the PLT will **not** run the tests.

DA1458x/DA1468x Production Line Tool

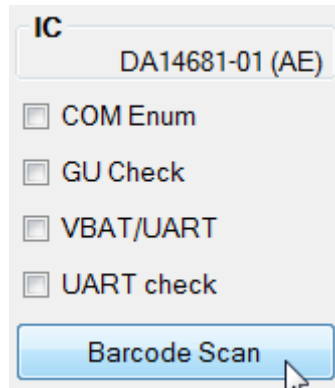

Figure 101: Barcode Scan Option in GUI PLT

Two different device BD address scanning procedures are supported. If the same BD address is used twice an error message appears in the DUT panel. It then waits for a unique BD address. An example is shown in Figure 103.

1. *Scan DUT position.* In this mode the user must first scan the DUT position and then the BD address. The string used for the position of each DUT is "TEST POSITION 0xx" where "xx" is the DUT number 1 to 16.
2. *Automatic DUT position.* The scanned BD address will be assigned to the selected DUT. DUT selection is done automatically. The PLT starts from the first active DUT and goes to the next after a successful BD address scan. The user can change the selected DUT via the controls shown in Figure 102. If the scanned BD address was successfully assigned, the PLT will automatically select the next active DUT and wait for a new BD address to be scanned.



Figure 102: Barcode Scanner Controls

If the Custom Memory Data test requires data to be scanned then the user must scan the Custom data after the BD address for each DUT. Homekit Setup Code Scan Example provides detailed steps showing how to scan both BD addresses and data for the Custom Memory data test.

After all active DUTs have BD addresses assigned, the user should press the *END* button in the controls to return to the main screen. Pressing the *START* button will then start the test execution.

**Note:** If the *Barcode Scan* button is pressed again, all BD addresses will be reset and the BD address assignment procedure will begin again.

DUT	BD Address	Code	Status	Result
1	11:22:33:44:55:06		BARCODE SCANNER BD ADDRESS OK	PASS
2	00:00:00:00:00:00		BD ADDRESS 11:22:33:44:55:06 ALREADY USED. RETRY	CHECK
3	11:22:33:44:55:08		BARCODE SCANNER BD ADDRESS OK	PASS
4	11:22:33:44:55:09		BARCODE SCANNER BD ADDRESS OK	PASS
9	11:22:33:44:55:13		BARCODE SCANNER BD ADDRESS OK	PASS
10	00:00:00:00:00:00			
11	00:00:00:00:00:00			
12	00:00:00:00:00:00			

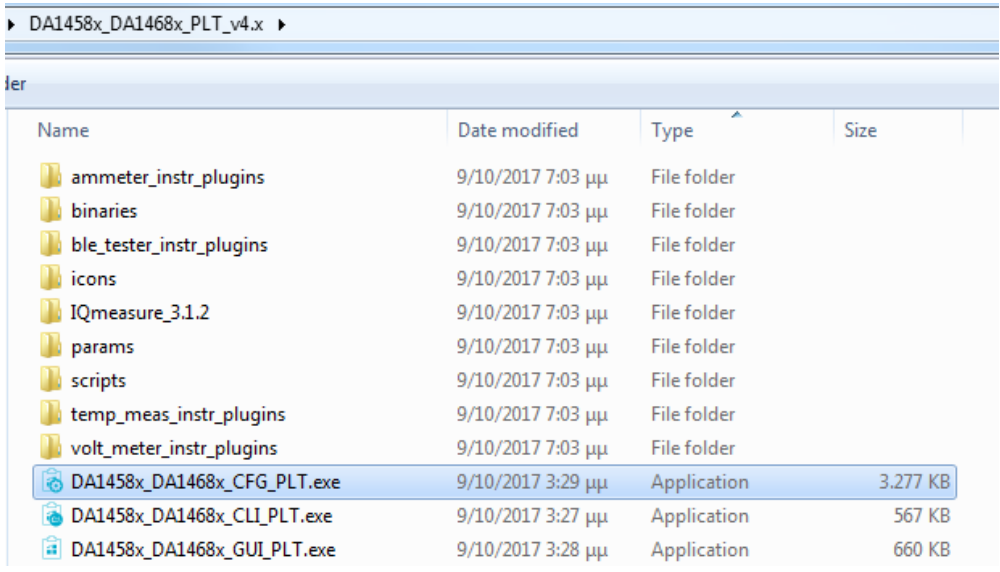

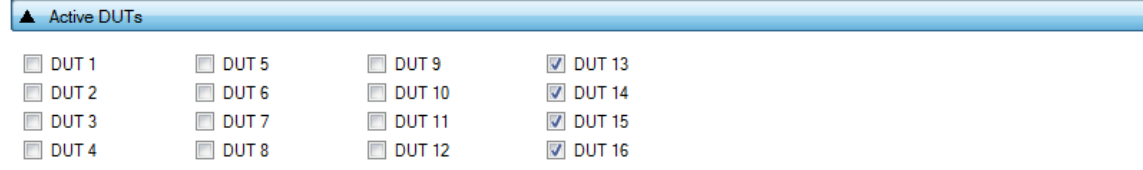

Figure 103: Barcode Scan - BD Address Assignment

DA1458x/DA1468x Production Line Tool

7.3.2.1 Homekit Setup Code Scan Example

An example of using the barcode scanner and Custom Memory Data will be given. A barcode scanner will be used to scan different Homekit setup codes. PLT will call the *SetupCode\_Generator\_680.exe* application to create the binaries that contains the DUTs serial numbers and the hashed version of the setup codes. Finally it will program the binaries to the DUTs. The process will be described in Table 94. The example will use DA14681-01 DUTs and configure the PLT such that to perform XTAL trim test, RF test and homekit setup code scanning and programming.

Table 94: Homekit Setup Code Scan Example

#	Action
1	Copy PLT software DA1458x_DA1468x_PLT_v_4.x.x.x under C:\ directory.
2	<p>Open <i>DA1458x_DA1468x_CFG_PLT.exe</i>.</p> 
3	<p>Go to <i>Hardware Setup-&gt; Device IC</i> and select <i>DA14681-01 (AE)</i>. Press the <i>Save*</i> button.</p> 
4	<p>Go to <i>Hardware Setup-&gt; Active DUTs</i> and select <i>DUT13, DUT14, DUT15</i> and <i>DUT16</i>. Press the <i>Save*</i> button.</p> 
5	<p>Go to <i>Hardware Setup-&gt; Golden Unit COM Port</i> and auto-detect the COM port. Press the <i>Auto</i> button. Press the <i>Save*</i> button.</p> 

DA1458x/DA1468x Production Line Tool

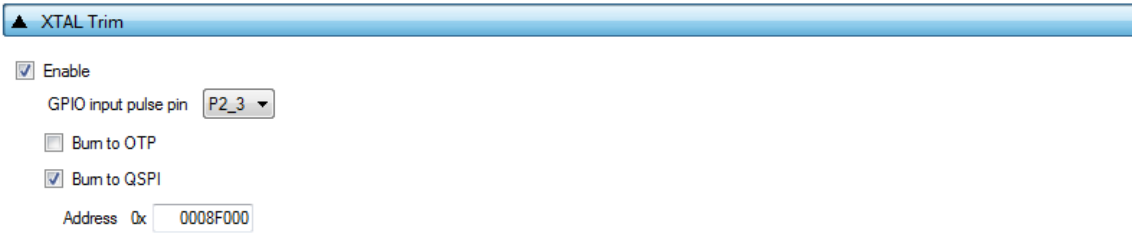
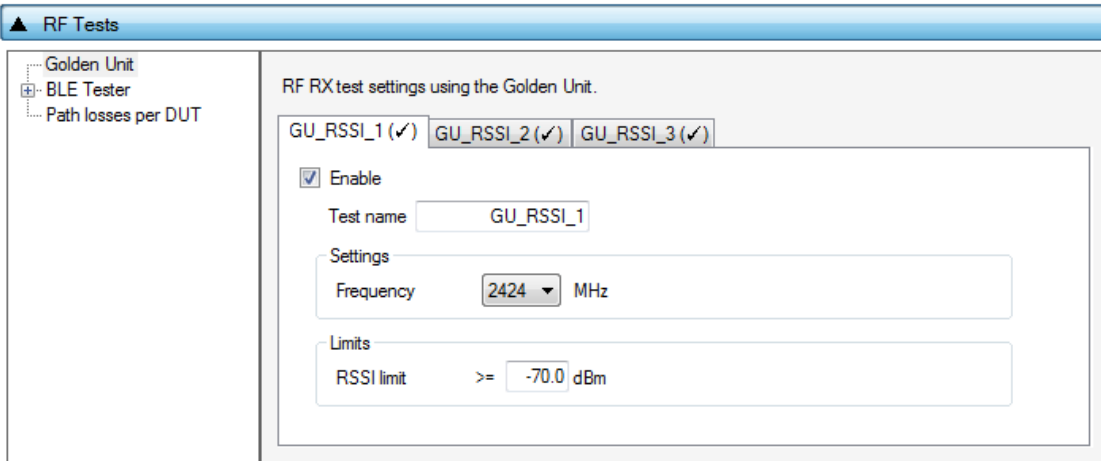
#	Action
6	<p>Go to <i>Test Settings</i>-&gt;<i>XTAL Trim</i> and enable the settings as shown in the following picture. Press the <i>Save*</i> button.</p> <p>These settings will enable the XTAL trim calibration test. The result of the XTAL trim calibration will be saved into QSPI flash. Dialog SDK firmware is able to read the value from this specific QSPI address (0x8F000) and apply it to the appropriate chipset XTAL trim register.</p> 
7	<p>Go to <i>Test Settings</i>-&gt;<i>RF Tests</i> and enable the settings shown in the following picture. Three RF tests at channels 2424MHz, 2450MHz and 2476MHz are already enabled in the PLT by default. Check that all settings are correct. Press the <i>Save*</i> button.</p> 
8	<p>Deselect everything in <i>Memory Functions</i> tab. No need to burn any image for this example. Press the <i>Save*</i> button.</p>
9	<p>Connect to the PC a USB to Serial (COM) barcode scanner instrument. Keep the Windows COM port assigned to the instrument.</p>



DA1458x/DA1468x Production Line Tool

#	Action
10	<p>Go to <i>Memory Header-&gt;Custom Memory Data</i> and enable the settings shown in the following picture. Change the <i>Scanner Interface</i> COM port according to the COM port assigned to the barcode scanner in step 9. Press the <i>Save*</i> button.</p>
11	Close <i>DA1458x_DA1468x_CFG_PLT.exe</i> and open <i>DA1458x_DA1468x_GUI_PLT.exe</i> .
12	<p>The initial <i>DA1458x_DA1468x_GUI_PLT.exe</i> screen will appear.</p>

DA1458x/DA1468x Production Line Tool

- #**    **Action**
- 13    Press the *Barcode Scan* button on the bottom left corner. The following screen will appear.
- 
- 14    Use the barcode scanner instrument to scan four different homekit setup codes with specific format as this was described in [Table 16](#). Four different example codes are given next.
- 
- 15    When the barcodes, given in step 14, are scanned using the barcode scanner instrument the GUI PLT will be as shown next.
- 
- 16    If something goes wrong, either navigate to the different DUT Memory Data cells using the *PREV/NEXT* buttons or press the *END* button and then the *Barcode Scan* button again to restart the process. The previous scanned data will be erased.  
If everything went well just press the *END* button. The tool will return to its initial screen as shown in step 12.

DA1458x/DA1468x Production Line Tool

#	Action
17	<p>Press the Space keyboard key to start the PLT tests. The PLT process will proceed.</p>
18	<p>PLT will get the barcode scanned data for each DUT and call the <i>SetupCode_Generator_680.exe</i> to create four different binaries. The binaries will reside inside <i>DA1458x_DA1468x_PLT_v_4.x.x\executables\binaries</i>.</p>
19	<p>If everything finished with no error the following screen will be shown.</p>
20	<p>Press the FINISHED button to return to the main screen.</p>

DA1458x/DA1468x Production Line Tool

7.3.3 Running the GUI PLT and Executing Tests

The GUI PLT starts the test procedure when users press the *START* button. Before initiating the test procedure the GUI PLT will assign BD addresses to the active DUTs and check for any wrong configuration parameters. Immediately thereafter the testing procedure will begin. The GUI PLT will update the status of the procedure for each DUT and the Golden Unit (Figure 104). The *START* button is replaced by a progress bar indicating the progress of the tests.

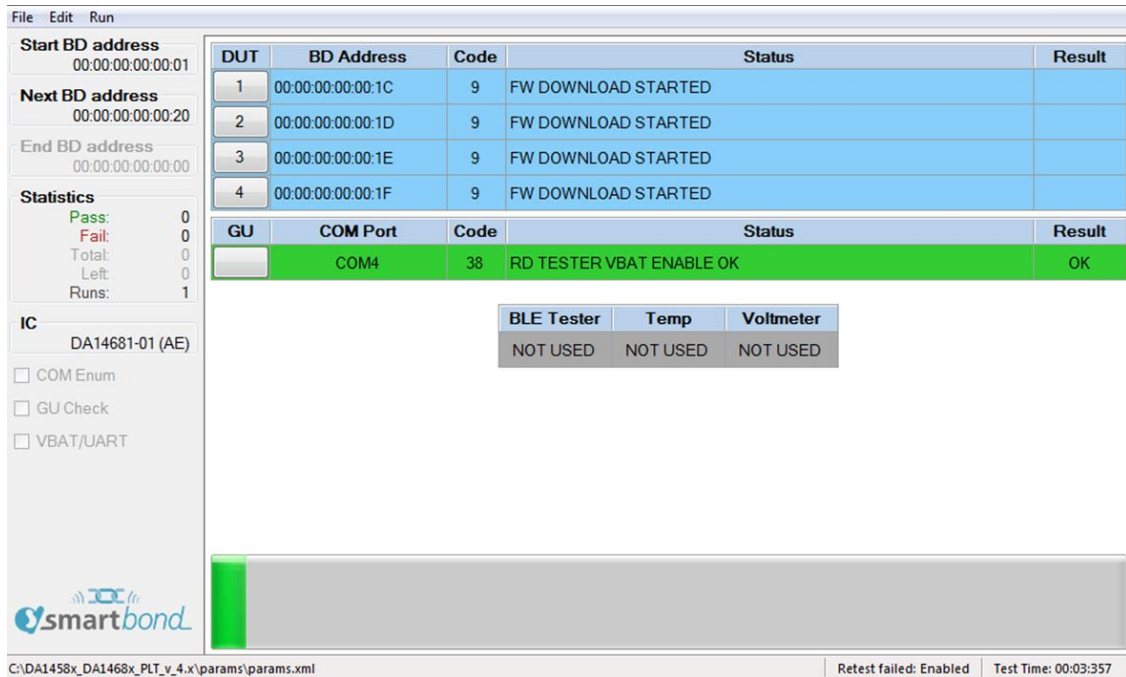

Figure 104: GUI PLT during Testing (1 of 2)

If an error in a DUT is found (Figure 105), the GUI PLT will show the status code, a brief description of the error and the color of the DUT's status line will turn red. At all times the DUT number button can be pressed to access the [DUT Log File](#) to get more details about the parameters used, calculated values and the reason of failure in the case of an error.

DA1458x/DA1468x Production Line Tool

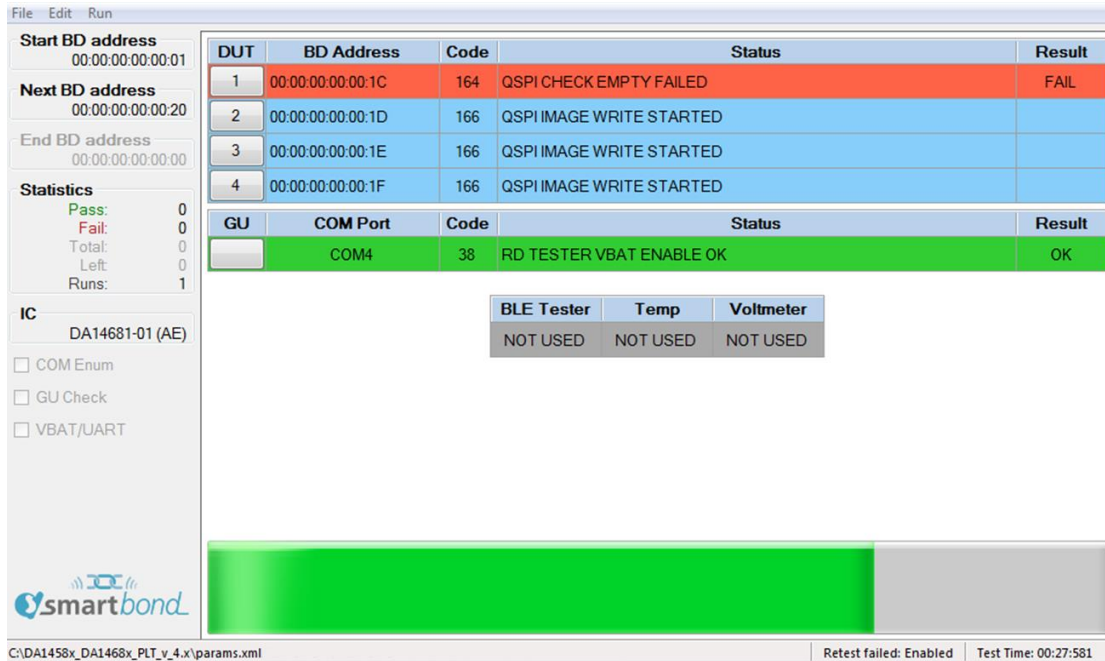

Figure 105: GUI PLT During Testing (2 of 2)

After the testing procedure is completed (Figure 106), the progress bar shows *FINISHED* and its color will be red if any DUT has failed, otherwise it will be green. If there is an error and the *Retest failed DUTs* and *Ask to retry* options are enabled, a message will appear asking if the user would like to retest the failed DUTs, as shown in Figure 107. When the GUI PLT performs a retest run, all options (including the BD addresses) remain the same and only the tests that failed are retested. At this time the *CSV File* and all the *DUT Log Files* will be updated.

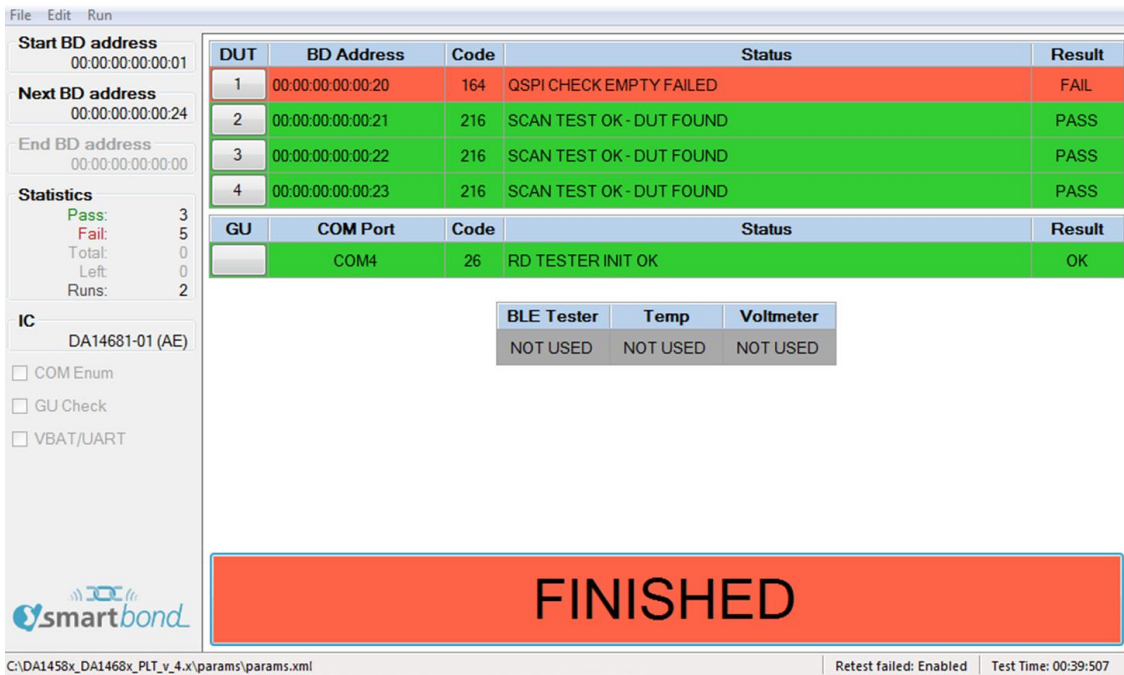

Figure 106: GUI PLT Tests Finished

DA1458x/DA1468x Production Line Tool

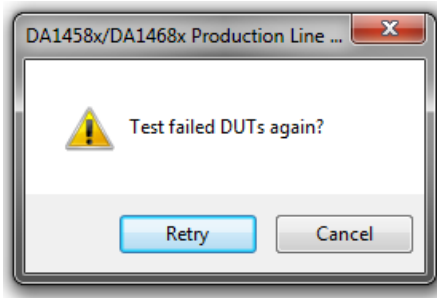

Figure 107: GUI PLT Retry Failed DUTs Message

If the DUT fails again, after the retest has finished the GUI PLT will remain in the *FINISHED* screen (Figure 106) with the *FINISHED* button shown in red.

7.3.4 Debug Console

Section 7.2.12.6 shows the debug settings for all PLT applications including the GUI PLT. If at least one debug session is enabled with the output set to *Console*, the GUI PLT will open a new console window showing the desired debug information.

Figure 108 shows an example of the *Debug Console*. Depending on the type of the message a different color is used: *DEBUG* messages are light blue, *INFO* messages are white and *ERROR* messages are red.

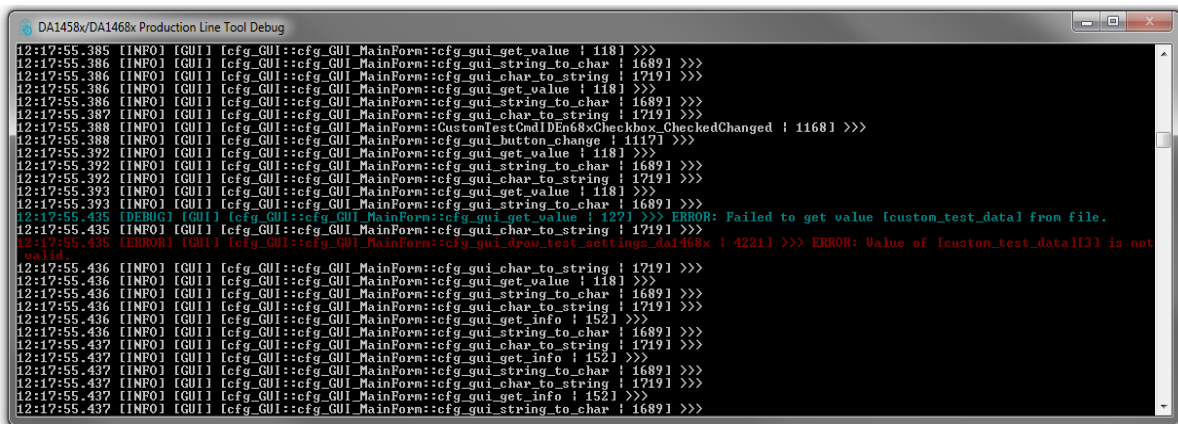

Figure 108: Debug Console



7.3.5 DUT Log File

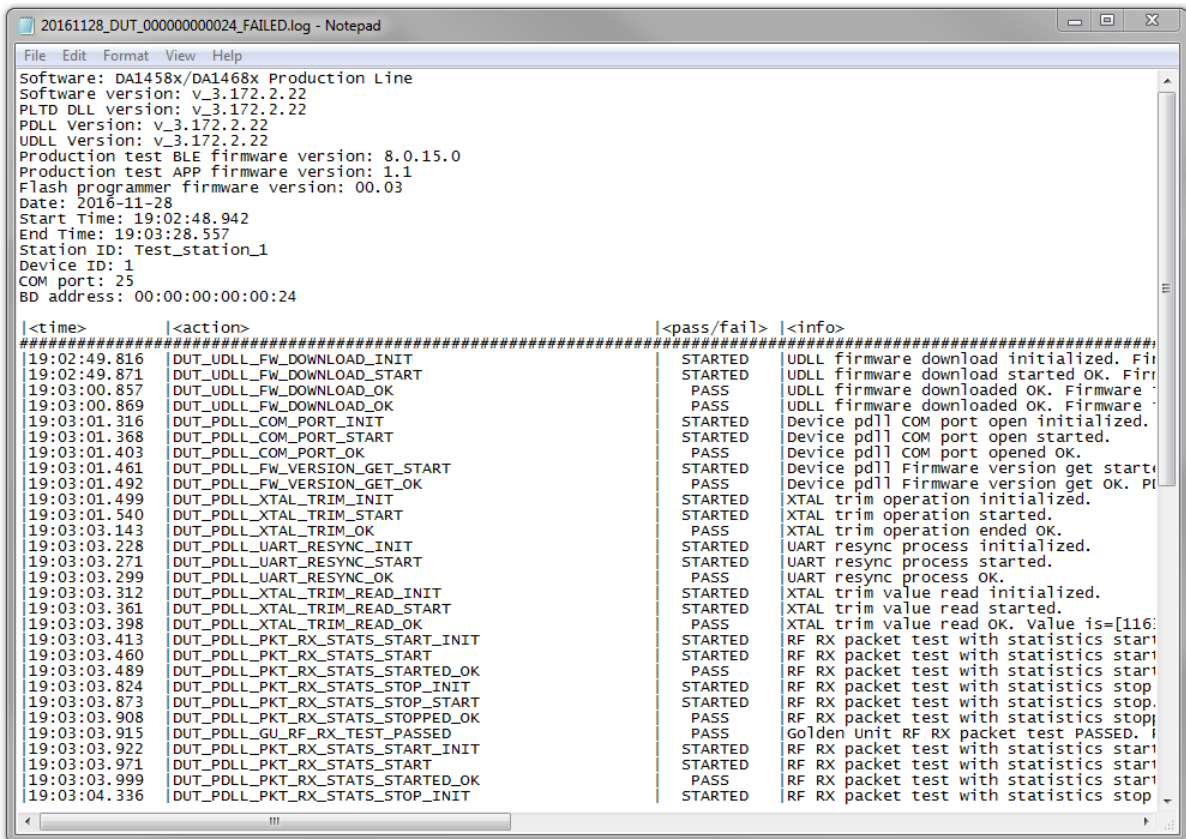

Figure 109: DUT Log File

Figure 109 shows a Log file generated for DUT1 during testing.

In the first few lines of the log a header is created giving vital information about the PLT hardware and the software. It includes the firmware and software version, the station name and test dates and times. It also holds information about the DUT, such as the connector number in the PLT hardware, the BD address assigned to it and the Windows COM port. For the DUTs that have failed, the log file is renamed with the word "\_ FAILED" at the end for easier retrieval.

The Log file is created at the beginning of each test, containing only the header and all information available at the time of creation. As the device testing progresses the status of each test is written at the end of the log file, including information about the DUT and a timestamp of the event. After the tests finish the header is updated with the end time of the test and the firmware versions, which were retrieved during testing.

DA1458x/DA1468x Production Line Tool

7.3.6 CSV File

Start time	End time	DUT	BD address	Overall st:	COM port	FW downl	FW path 2	FW versio	FW versio	QSPI erase	QSPI chec	QSPI burn	QSPI imag	FW dd
17:08:53	17:10:43	1	00:00:00:0	FAIL	25	PASS	C:\Users\j...	PASS	00.03	PASS	FAIL			
17:08:53	17:10:43	2	00:00:00:0	FAIL	26	PASS	C:\Users\j...	PASS	00.03	PASS	FAIL			
17:10:48	17:13:24	1	00:00:00:0	FAIL	25	PASS	C:\Users\j...	PASS	00.03	PASS	FAIL			
17:10:48	17:13:24	2	00:00:00:0	FAIL	26	PASS	C:\Users\j...	PASS	00.03	PASS	PASS	FAIL	binaries\pxp_r	
17:13:30	17:16:39	1	00:00:00:0	FAIL	25	PASS	C:\Users\j...	PASS	00.03	PASS	FAIL			
17:13:30	17:16:39	2	00:00:00:0	FAIL	26	PASS	C:\Users\j...	PASS	00.03	PASS	PASS	FAIL	binaries\pxp_r	
17:17:00	17:17:10	1	00:00:00:0	FAIL	25	FAIL	C:\Users\pdimopou\Desktop\DA1458x_DA1468x_PLT_v_4.0\source\productio							
17:17:00	17:17:10	2	00:00:00:0	FAIL	26	PASS	C:\Users\j...	FAIL						
17:17:55	17:18:13	1	00:00:00:0	FAIL	25	FAIL	C:\Users\pdimopou\Desktop\DA1458x_DA1468x_PLT_v_4.0\source\productio							
17:17:55	17:18:13	2	00:00:00:0	FAIL	26	PASS	C:\Users\j...	FAIL						
17:19:56	17:20:22	1	00:00:00:0	FAIL	25	PASS	C:\Users\j...	PASS	00.03	PASS	FAIL			
17:19:56	17:20:22	2	00:00:00:0	PASS	26	PASS	C:\Users\j...	PASS	00.03	PASS	PASS	PASS	binaries\pxp_r	
17:21:39	17:22:16	1	00:00:00:0	FAIL	25	PASS	C:\Users\j...	PASS	00.03	PASS	FAIL			
17:21:39	17:22:16	2	00:00:00:0	FAIL	26	PASS	C:\Users\j...	PASS	00.03	PASS	FAIL			
17:22:18	17:25:41	1	00:00:00:0	FAIL	25	PASS	C:\Users\j...	PASS	00.03	PASS	FAIL			
17:22:18	17:25:41	2	00:00:00:0	FAIL	26	PASS	C:\Users\j...	PASS	00.03	PASS	FAIL			
17:25:47	17:26:08	1	00:00:00:0	FAIL	25	PASS	C:\Users\j...	PASS	00.03	PASS	FAIL			
17:25:47	17:26:08	2	00:00:00:0	PASS	26	PASS	C:\Users\j...	PASS	00.03	PASS	PASS	PASS	binaries\pxp_r	
18:57:45	18:58:48	1	00:00:00:0	FAIL	25	PASS	C:\Users\j...	PASS	00.03	PASS	FAIL			PASS
18:57:45	18:58:48	2	00:00:00:0	PASS	26	PASS	C:\Users\j...	PASS	00.03	PASS	PASS	PASS	binaries\	PASS
18:57:45	18:58:48	3	00:00:00:0	PASS	27	PASS	C:\Users\j...	PASS	00.03	PASS	PASS	PASS	binaries\	PASS
18:57:45	18:58:48	4	00:00:00:0	PASS	28	PASS	C:\Users\j...	PASS	00.03	PASS	PASS	PASS	binaries\	PASS
18:59:40	19:00:20	1	00:00:00:0	FAIL	25	PASS	C:\Users\j...	PASS	00.03	PASS	FAIL			PASS
18:59:40	19:00:20	2	00:00:00:0	PASS	26	PASS	C:\Users\j...	PASS	00.03	PASS	PASS	PASS	binaries\	PASS

Figure 110: CSV File

Figure 110 shows an example of a generated CSV file. As with the DUT Log File, the PLT software and hardware information are shown along with valuable DUT information. The CSV file keeps information about all the production tests of a single day. A new CSV file will be created every day.



DA1458x/DA1468x Production Line Tool

7.4 CLI PLT Application

The CLI PLT (DA1458x\_DA1468x\_CLI\_PLT.exe) is a Command Line Interface application with similar functionality and features as the GUI PLT. It performs the device testing and memory programming. At the same time it allows users to monitor the test procedure in detail. It supports the same configuration file created from the CFG PLT and can run the same tests as the GUI PLT.

7.4.1 CLI Introduction

Figure 111 shows the initial screen of the CLI PLT software. The CLI PLT can be executed from a command line prompt, passing arguments externally and initiating the tests immediately. This is useful for scripting/batch files as shown in section 7.4.4.

Parameters are automatically loaded from the params/params.xml file when the CLI PLT starts. If there is a parameter error, a warning will be shown. It is recommended to run the 'x' command or start the CFG PLT before running the tests and check the configuration parameters. If a change is made to the params.xml configuration file while CLI is open, the file should be reloaded using the 'i' command.

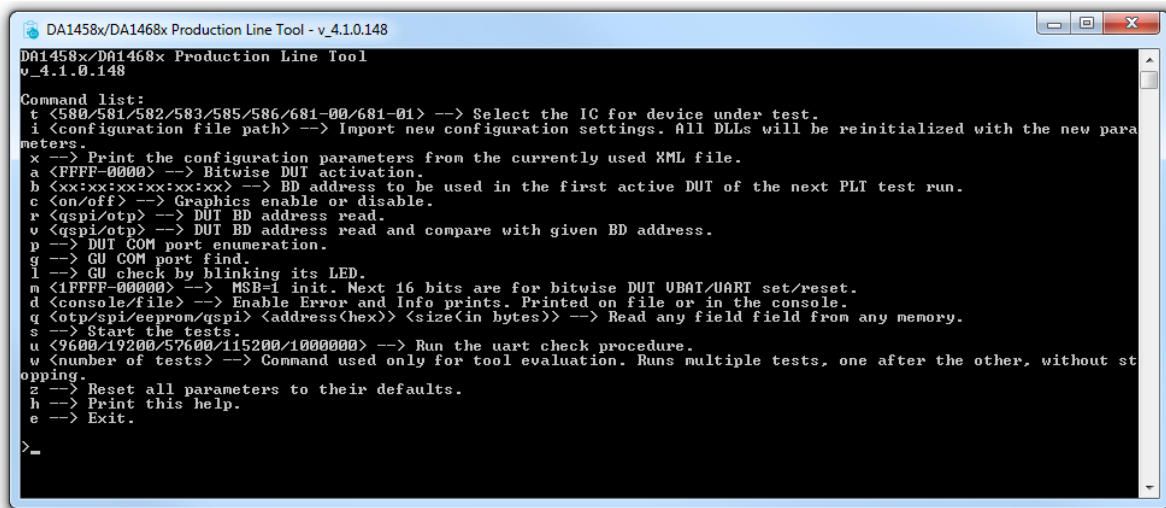

Figure 111: CLI Software Start Screen

7.4.2 CLI Commands

Table 95 lists all available CLI commands. A list with brief description of these commands can be printed using the 'h' command.

Table 95: CLI Commands

Command	Arguments	Description
t	<ul style="list-style-type: none"> <li>580</li> <li>581</li> <li>582</li> <li>583</li> <li>585</li> <li>586</li> <li>680</li> <li>681</li> </ul>	Selects the type of IC that the DUT uses.  This option will change the DUT IC setting in the configuration file and reload all the settings if there is a switch from any DA1458x IC to a DA1468x IC and vice versa.  <b>Example:</b> "t 580".
i	Path to XML configuration file.	Initializes the PLT with the parameters found in the params.xml file.  <b>Example:</b> "i params\params.xml".

**DA1458x/DA1468x Production Line Tool**

Command	Arguments	Description
x	<i>none</i>	Print the configuration parameters from the currently used XML file.
a	Hex values from "FFFF" to "0000".	Bitwise DUT activation. Sets the active DUTs to be tested. <b>Examples:</b> <ul style="list-style-type: none"> <li>• "a 1": Only DUT 1 will be activated and tested.</li> <li>• "a 9": DUTs 1 and DUT 4 will be activated and tested.</li> </ul>
b	xx:xx:xx:xx:xx:xx	Sets the start BD address of the first active DUT. <b>Example:</b> "b FE:00:11:22:33:44"
c	on/off	Enables or disables the graphics debug output of the CLI. Useful in the read BD address command <i>r</i> , in order to see only the DUT BD address returned and not the entire process. <b>Example:</b> "c on"
r	<ul style="list-style-type: none"> <li>• qspi</li> <li>• otp</li> </ul>	Reads the BD addresses of the active DUTs. It is better to disable the graphics beforehand by running the command "c off". <b>Example:</b> "r qspi"
v	<ul style="list-style-type: none"> <li>• qspi</li> <li>• otp</li> </ul>	Verify the BD addresses of the active DUTs. It is better to disable the graphics beforehand by running the command "c off". <b>Example:</b> "v qspi"
p	<i>none</i>	Execute the automatic DUT Window COM port enumeration.
g	<i>none</i>	Execute the automatic GU Window COM port enumeration.
l	<i>none</i>	Run the Golden Unit sanity check. The Golden Unit will start blinking its red LED.
m	First character: "1" or "0". Then hex value from "FFFF" to "0000".	MSB character should be '1' the first time this command is executed. Consecutive 'm' commands should have the MSB character set to '0'. The next 16 bits are used for bitwise DUT VBAT/UART enable/disable. <b>Example:</b> "m 1FFFF"
d	<ul style="list-style-type: none"> <li>• console</li> <li>• file</li> </ul>	Use this option to enable error and info prints. Choose file output or console output. Only the <i>file</i> option is currently supported. <b>Example:</b> "d file"
q	First argument <ul style="list-style-type: none"> <li>• otp</li> <li>• spi</li> <li>• eeprom</li> <li>• qspi</li> </ul> Second argument <ul style="list-style-type: none"> <li>• The address offset in hexadecimal</li> </ul> Third argument <ul style="list-style-type: none"> <li>• The size in bytes to read</li> </ul>	This option can read from any memory, for any address offset up to 256 bytes of data.
s	<i>none</i>	Starts the tests.
u	<ul style="list-style-type: none"> <li>• 9600</li> <li>• 19200</li> <li>• 57600</li> <li>• 115200</li> <li>• 1000000</li> </ul>	This command performs a UART check connection for all the active DUTs for a specific Baud rate.
w	Number of tests to run.	This command is used only for PLT evaluation. It starts multiple tests. These are executed one after the other without user intervention.

DA1458x/DA1468x Production Line Tool

Command	Arguments	Description
z	none	Resets all the XML parameters to their defaults.
h	none	Help print out. Prints the list of the CLI commands that are available.
e	none	Exits the application.

7.4.3 Running the CLI and Executing Tests

There are a number of options to be called in order to make sure that the CLI PLT is set up correctly. Each of following commands is explained in Table 95.

- Using the help command ('h') the entire CLI command list will be shown.

Example: >h

Set Console Options

- To redirect the debugging messages to the file use command 'd'. This option is going to replace the UI debug values in the configuration file.

Example: >d file

- To show or hide any prints in the Console window use command 'c' with on/off argument.

Example: >c on

Check, Reset, Reload and Change Settings

- Because the configuration file is automatically loaded, use the 'x' command (Figure 112) to see the loaded settings. Errors will be shown in red.

Example: >x

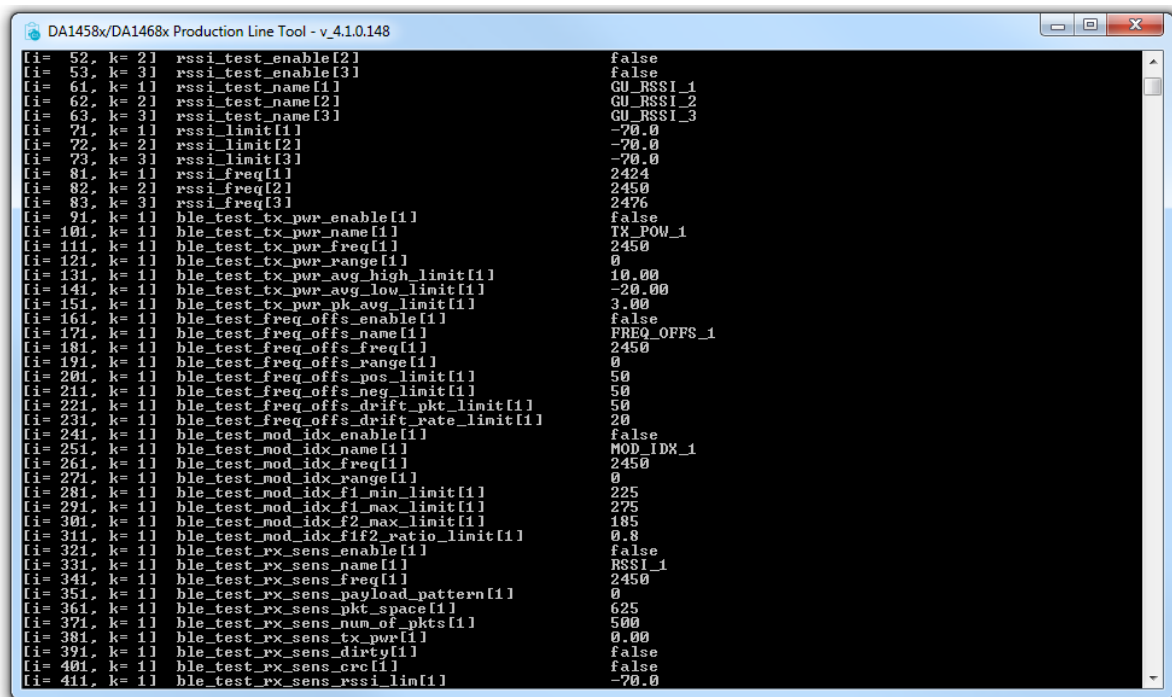

Figure 112: CLI PLT Print Settings (x Command)

- To Reset the XML parameters in the configuration file to their defaults use the 'z' command.

Example: >z

- To reload the configuration file or to load another one use the 'i' command.

## DA1458x/DA1468x Production Line Tool

Example: `>i params/params.xml`

- To change only the selected device IC use the 't xxx' command, where 'xxx' is the desired IC selection. If a change from DA1458x to DA1468x (and vice versa) is made, all the settings will be reloaded.

Example: `>t 580`

- To change the active DUTs use the 'a' command. As an argument a 16-bit hexadecimal value is used, which is the bitwise representation of the active DUTs with DUT 1 being the LSB. This command will replace the `dut_num_x` values in the configuration file.

The following example will enable only DUT1, DUT2, DUT15 and DUT 16.

Example: `>a C003`

- To change the BD address that will be used in the next run use the 'b' command. This option is going to replace the *BD address* and *Statistics* values in the configuration file.

Example: `>b 00:00:00:00:00:01`

### Hardware Specific Tests

- To automatically find the Windows COM Port assigned to the Golden Unit use the 'g' command. This command will replace the `gu_com_port` value in the configuration file.

Example: `>g`

- To verify that the Golden Unit COM port is found correctly and to check if the Golden Unit is ready run the 'l' command.

Example: `>l`

- To automatically find the Windows COM Port assigned for each DUT use the 'p' command. This command will replace the `com_port_dut_x` values in the configuration file.

Example: `>p`

DUT	BD ADDRESS	CODE	STATUS	RESULT
2	00:00:55:00:00:01	0	NOT ACTIVE	
3	00:00:55:00:00:02	2	COM PORT IDENTIFY STARTED	
4	00:00:55:00:00:03	3	COM PORT IDENTIFY OK	PASS
GU	COM4	34	RD TESTER COM LOOPBACK OK	OK

Figure 113: CLI PLT DUT COM Port Enumeration ('p' Command)

- To run a UART error check use the 'u' command followed with a specific Baud rate.

Example: `>u 1000000`

### PLT Production Tests

- To check if there is a BD address written in the active DUTs use the 'r' command. To read the BD addresses and verify that they are the same as the ones currently assigned use the 'v' command. Both commands use 'qspi' or 'otp' as argument to define the memory header.

The following example will read the BD address from the QSPI memory header and compare it with the one currently assigned to the DUTs.

Example: `>v qspi`

DA1458x/DA1468x Production Line Tool

```

DUT  BD ADDRESS      CODE  STATUS                                     RESULT
2    00:00:55:00:00:01  177   QSPI BD ADDRESS COMPARED OK             PASS
3    00:00:55:00:00:02  177   QSPI BD ADDRESS COMPARED OK             PASS
4    00:00:55:00:00:03  177   QSPI BD ADDRESS COMPARED OK             PASS
GU   COM4              26    RD TESTER INIT OK                       OK

DUT  QSPI BD ADDRESS  GIVEN BD ADDRESS  STATUS
02   00:00:55:00:00:01  00:00:55:00:00:01  MATCH
03   00:00:55:00:00:02  00:00:55:00:00:02  MATCH
04   00:00:55:00:00:03  00:00:55:00:00:03  MATCH

return status = 0xFF1
    
```

Figure 114: CLI PLT Read and Compare BD Address in QSPI ('v' Command)

- Use the 's' command to begin testing with the current configuration. Figure 115 shows the CLI during the testing. After all the tests have finished, the result remains on the screen as shown in Figure 116.

```

DUT  BD ADDRESS      CODE  STATUS                                     RESULT
2    00:00:55:00:00:01  9     FW DOWNLOAD STARTED                     [Blue]
3    00:00:55:00:00:02  9     FW DOWNLOAD STARTED                     [Blue]
4    00:00:55:00:00:03  9     FW DOWNLOAD STARTED                     [Blue]
GU   COM4              38    RD TESTER VBAT ENABLE OK                OK

BLE TESTER  TEMP  UOLT
NOT USED   NOT USED  NOT USED
    
```

Figure 115: CLI PLT During Testing

```

DUT  BD ADDRESS      CODE  STATUS                                     RESULT
2    00:00:55:00:00:01  216   SCAN TEST OK - DUT FOUND                PASS
3    00:00:55:00:00:02  216   SCAN TEST OK - DUT FOUND                PASS
4    00:00:55:00:00:03  216   SCAN TEST OK - DUT FOUND                PASS
GU   COM4              26    RD TESTER INIT OK                       OK

BLE TESTER  TEMP  UOLT
NOT USED   NOT USED  NOT USED

DUT  QSPI BD ADDRESS  GIVEN BD ADDRESS  STATUS
02   00:00:55:00:00:01  00:00:55:00:00:01  MATCH
03   00:00:55:00:00:02  00:00:55:00:00:02  MATCH
04   00:00:55:00:00:03  00:00:55:00:00:03  MATCH

return status = 0xFF1
    
```

Figure 116: CLI PLT Testing Finished

- Use the 'q' command to read from any memory up to 156 bytes of data. The following example will read the BD address (6 bytes from offset 0x47FD4) of a DA14580 DUT.  
Example: >q otp 47FD4 6

Other Test Commands

- Use the 'm' command to power on and access the DUTs to perform further testing. This will open the VBAT and the COM ports from the PLT hardware to the DUTs. As an argument a '0' or '1' character is used to reset the PLT hardware. This is followed by a 16-bit hexadecimal number, which is the bitwise representation of the DUTs to use, with DUT 1 being the LSB.

In the following example the PLT hardware will be reset and DUTs 1, 2, 15 and 16 will be used.

Example: >m 1C003

---

**DA1458x/DA1468x Production Line Tool**
**7.4.4 Using CLI Commands as Arguments**

It is possible to start the CLI program with the commands described in section 7.4.3 as arguments. This is useful for scripting/batch files.

```
C:\executables>DA1458x_DA1468x_CLI_PLT.exe -a 0001 -b 00:00:55:00:00:01 -s -b 00:00:55:00:00:01 -v qspi
```

**Figure 117: CLI with Commands as Arguments**

The example shown in Figure 117 will perform the following commands:

1. '-a 0001': Set the DUT1 as the only active DUT.
2. '-b 00:00:55:00:00:01'. Assign as the first BD address to be assigned the 00:00:55:00:00:01. This BD address will be used in DUT1 as it is the only active DUT.
3. '-s': Perform the tests. BD address write in QSPI header should be enabled for the following test to pass.
4. '-b 00:00:55:00:00:01': After the tests finish the BD address will be incremented, this command will reset it to 00:00:55:00:00:01.
5. '-v qspi': Read only the BD address written in the QSPI header and compare it with the one assigned to the DUT1. These are the same.

## 8 Example Usage

In this section a simple example of the PLT will be described using two DA14580 devices. The example test procedure is explained step-by-step in [Table 96](#).

The tests to run in this example are the XTAL trim, RF RSSI test, SPI erase, SPI check empty and SPI image write.

Two DUTs will be used at PLT DUT connector positions DUT1 and DUT2.

**Table 96: DA14580 PLT Example Usage**

Step	Description		
<b>Hardware Connections</b>			
1	Connect both DUTs to the PLT hardware as shown in <a href="#">DA1458x DK PRO Motherboard Connection</a> . Four cables are needed. In order to use the SPI Flash memory a custom triple-jumper must be used.		
<b>CFG GUI Settings</b>			
2	Open CFG PLT and make the following selections.		
3	Hardware Setup		
		Device IC	Select DA14580 and then Save.
		Golden Unit COM Port	Press the Auto Button and then Save.
		Active DUTs	Enable only DUT1 and DUT2 and Save.
		DUT COM Ports	Press Enum button and then Save.
4	VBAT/Reset Mode		
		VBAT low duration	Set a time for the POR that is sufficient enough for the DUTs to discharge their capacitors during the POR.
		VBAT/Reset Mode	Since the DUTs will be powered from the PLT hardware and the Reset signal will not be used, use the VBAT only option.
5	General		
		Statistics	Press the Reset Button and then Save.

### DA1458x/DA1468x Production Line Tool

Step	Description		
		Test Options	<p>Enable all options and then press Save.</p> <p>Production tests are required to be enabled for the XTAL Trim and the RF tests to run.</p> <p>Memory programming is required for the QSPI erase and check empty functions.</p> <p>Disable the rest of the options.</p>
6	UART		
	<p>▲ UART Boot Pins Setup</p> <p>TX-RX pins TX: P0_4, RX: P0_5</p> <p>▲ UART Baud Rate</p> <p>Baud Rate 1000000</p> <p>▲ UART Programming GPIOs Setup</p> <p><input type="checkbox"/> Enable</p> <p>Port TX 0 Pin TX P0_4</p> <p>Port RX 0 Pin RX P0_5</p>	<p>UART Boot Pin Setup</p> <p>TX: P0_4, RX: P0_5</p> <p>UART Baud Rate</p> <p>1000000</p>	
7	Test Settings		
	<p>▲ XTAL Trim</p> <p><input checked="" type="checkbox"/> Enable</p> <p>GPIO input pulse pin P0_5</p> <p><input type="checkbox"/> Burn to OTP</p> <p>▲ RF Tests</p> <p>Golden Unit</p> <p>BLE Tester</p> <p>Path losses per DUT</p> <p>RF RX test settings using the Golden Unit.</p> <p>Test 1</p> <p><input checked="" type="checkbox"/> Enable</p> <p>Settings</p> <p>Frequency 2424 MHz</p> <p>Limits</p> <p>RSSI limit &gt;= -70.0 dBm</p>	<p>XTAL Trim</p> <p>Check <i>Enable</i> in XTAL Trim. Select the same pin as the <i>UART Rx</i>, <i>P0_5</i>.</p> <p><i>Burn to OTP</i> is disabled</p> <p>RF Tests - Golden Unit</p> <p>Only one test is enabled for this example.</p> <p>In Golden Unit:</p> <ul style="list-style-type: none"> <li>• Check <i>Enable</i></li> <li>• Select 2424 MHz as <i>frequency</i></li> <li>• Set the <i>RSSI limit</i> to -70 dBm</li> </ul>	





DA1458x/DA1468x Production Line Tool

Step	Description	
8	<div style="display: flex; justify-content: space-between;"> <div style="width: 45%;"> <p>SPI write 1</p> <p><input checked="" type="checkbox"/> Write enable</p> <p>Test name <input type="text"/></p> <p>Write image in chunks of <input type="text" value="3960"/> bytes</p> <p><input checked="" type="checkbox"/> Verify image</p> <p><input checked="" type="checkbox"/> Bootable image</p> <p>Start address 0x <input type="text" value="00000000"/></p> <p><input type="checkbox"/> Different image per DUT</p> <p>Image path <input type="text" value="binaries\prox_reporter_580.bin"/></p> </div> <div style="width: 20%;"> <p>Write 1 test</p> </div> <div style="width: 30%;"> <p>Check Write enable</p> <p>Check Verify image</p> <p>Check Bootable image</p> <p>Make sure prox_reporter_580.bin is selected.</p> </div> </div>	
9	OTP Header	
	General	Disable all options
	BD address	Disable all options
<b>GUI PLT</b>		
10	<p>Open GUI PLT.</p> <p>The screenshot shows the GUI PLT interface with the following elements:</p> <ul style="list-style-type: none"> <li>File Edit Run menu bar</li> <li>Start BD address: 00:00:00:00:00:01</li> <li>Next BD address: 00:00:00:00:00:01</li> <li>End BD address: 00:00:00:00:00:00</li> <li>Statistics: Pass: 0, Fail: 0, Total: 0, Left: 0, Runs: 0</li> <li>IC: DA14580</li> <li>COM Enum, GU Check, VBAT/UART checkboxes</li> <li>smartbond logo</li> <li>Large START button</li> <li>Footer: C:\Release\params\params.xml   Retest failed: Enabled   Test Time: 00:00:00</li> </ul>	

DA1458x/DA1468x Production Line Tool

Step	Description				
11	<p>Press Space Bar to begin testing</p> <p>The following picture shows the UART channels (in red) for both DUTs for the entire PLT run. The green marks are the timings between each of the active tests.</p> <p>Log files for both the DUTs are created. The following picture shows the test steps from the log file of DUT1 with the timing marks from the logic analyzer capture. These marks are described below. From the log file the total time of each test can be calculated.</p> <pre>  &lt;time&gt;           &lt;action&gt;           &lt;pass/fail&gt;  &lt;info&gt; ----- ----- ----- ----- 17:51:11.321  DUT_UDLL_FW_DOWNLOAD_INIT   T1   STARTED  UDLL firmware download initialized. Firmware 17:51:11.355  DUT_UDLL_FW_DOWNLOAD_START     STARTED  UDLL firmware download started OK. Firmware 17:51:15.646  DUT_UDLL_FW_DOWNLOAD_OK     PASS  UDLL firmware downloaded OK. Firmware is=( 17:51:15.652  DUT_UDLL_FW_DOWNLOAD_OK     PASS  UDLL firmware downloaded OK. Firmware is=( 17:51:15.873  DUT_PDLL_COM_PORT_INIT   T2   STARTED  Device pdll COM port open initialized. 17:51:15.899  DUT_PDLL_COM_PORT_START     STARTED  Device pdll COM port open started. 17:51:15.928  DUT_PDLL_COM_PORT_OK     PASS  Device pdll COM port opened OK. 17:51:15.982  DUT_PDLL_FW_VERSION_GET_START     STARTED  Device pdll Firmware version get started. 17:51:16.003  DUT_PDLL_FW_VERSION_GET_OK     PASS  Device pdll Firmware version get OK. PDLL v 17:51:16.008  DUT_PDLL_XTAL_TRIM_INIT   T3   STARTED  XTAL trim operation initialized. 17:51:16.028  DUT_PDLL_XTAL_TRIM_START     STARTED  XTAL trim operation started. 17:51:18.141  DUT_PDLL_XTAL_TRIM_OK     PASS  XTAL trim operation ended OK. 17:51:18.207  DUT_PDLL_UART_RESYNC_INIT     STARTED  UART resync process initialized. 17:51:18.234  DUT_PDLL_UART_RESYNC_START     STARTED  UART resync process started. 17:51:18.249  DUT_PDLL_UART_RESYNC_OK     PASS  UART resync process OK. 17:51:18.259  DUT_PDLL_XTAL_TRIM_READ_INIT     STARTED  XTAL trim value read initialized. 17:51:18.283  DUT_PDLL_XTAL_TRIM_READ_START     STARTED  XTAL trim value read started. 17:51:18.309  DUT_PDLL_XTAL_TRIM_READ_OK     PASS  XTAL trim value read OK. Value is=[1428]. 17:51:18.316  DUT_PDLL_PKT_RX_STATS_START_INIT   T4   STARTED  RF RX packet test with statistics start ini 17:51:18.342  DUT_PDLL_PKT_RX_STATS_START     STARTED  RF RX packet test with statistics start. 17:51:18.367  DUT_PDLL_PKT_RX_STATS_STARTED_OK     PASS  RF RX packet test with statistics started ( 17:51:18.686  DUT_PDLL_PKT_RX_STATS_STOP_INIT     STARTED  RF RX packet test with statistics stop init 17:51:18.712  DUT_PDLL_PKT_RX_STATS_STOP_START     STARTED  RF RX packet test with statistics stop. 17:51:18.729  DUT_PDLL_PKT_RX_STATS_STOPPED_OK     PASS  RF RX packet test with statistics stopped ( 17:51:18.739  DUT_PDLL_GU_RF_RX_TEST_PASSED     PASS  Golden Unit RF RX packet test PASSED. Freq 17:51:20.280  DUT_UDLL_FW_DOWNLOAD_INIT   T5   STARTED  UDLL firmware download initialized. Firmware 17:51:20.319  DUT_UDLL_FW_DOWNLOAD_START     STARTED  UDLL firmware download started OK. Firmware 17:51:22.056  DUT_UDLL_FW_DOWNLOAD_OK     PASS  UDLL firmware downloaded OK. Firmware is=( 17:51:22.065  DUT_UDLL_FW_DOWNLOAD_OK     PASS  UDLL firmware downloaded OK. Firmware is=( 17:51:22.072  DUT_UDLL_FW_VER_GET_INIT   T6   STARTED  UDLL 'firmware version get' operation initi 17:51:22.092  DUT_UDLL_FW_VER_GET_STARTED     STARTED  UDLL 'firmware version get' operation start 17:51:22.106  DUT_UDLL_FW_VER_GET_OK     PASS  UDLL 'firmware version get' operation ended 17:51:22.113  DUT_UDLL_SPI_ERASE_INIT   T7   STARTED  SPI erase operation initialized. 17:51:22.131  DUT_UDLL_SPI_ERASE_STARTED     STARTED  SPI erase operation started. Erase all SPI 17:51:22.318  DUT_UDLL_SPI_ERASE_OK     PASS  SPI erase operation ended OK. Erase all SPI 17:51:22.335  DUT_UDLL_SPI_CHECK_EMPTY_INIT   T8   STARTED  SPI check empty operation initialized. 17:51:22.360  DUT_UDLL_SPI_CHECK_EMPTY_STARTED     STARTED  SPI check empty operation started, all SPI 17:51:23.496  DUT_UDLL_SPI_CHECK_EMPTY_OK     PASS  SPI check empty operation ended OK. all SPI 17:51:23.500  DUT_UDLL_SPI_IMG_WR_INIT   T9   STARTED  SPI image write operation initialized. Image 17:51:23.524  DUT_UDLL_SPI_IMG_WR_STARTED     STARTED  SPI image write operation started. Image tr 17:51:24.663  DUT_UDLL_SPI_IMG_WR_OK     PASS  SPI image write operation ended OK. Image i ----- ----- ----- -----   T10   </pre> <table border="1"> <tr> <td>T1</td> <td>The firmware download (prod_test_580.bin) begins. From the log file the test lasted for about 4.3 s, which can be verified from the logic analyzer capture.</td> </tr> <tr> <td>T2</td> <td>PLT begins the operation to get the version of the prod_test_580.bin firmware.</td> </tr> </table>	T1	The firmware download (prod_test_580.bin) begins. From the log file the test lasted for about 4.3 s, which can be verified from the logic analyzer capture.	T2	PLT begins the operation to get the version of the prod_test_580.bin firmware.
T1	The firmware download (prod_test_580.bin) begins. From the log file the test lasted for about 4.3 s, which can be verified from the logic analyzer capture.				
T2	PLT begins the operation to get the version of the prod_test_580.bin firmware.				

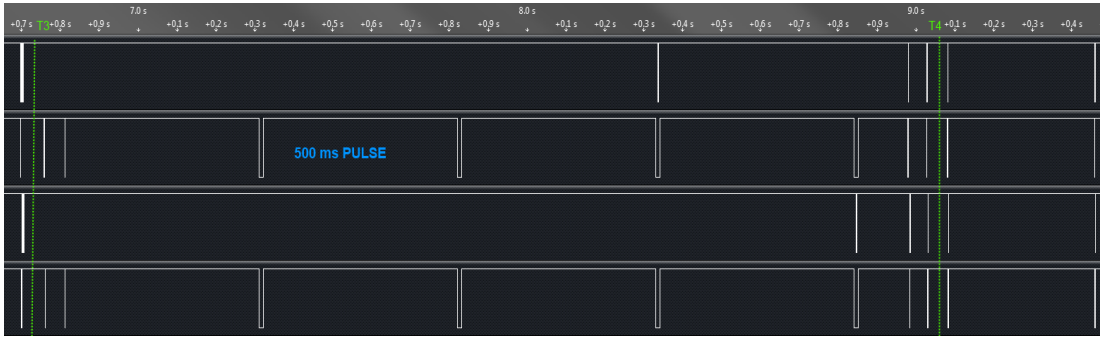
### DA1458x/DA1468x Production Line Tool

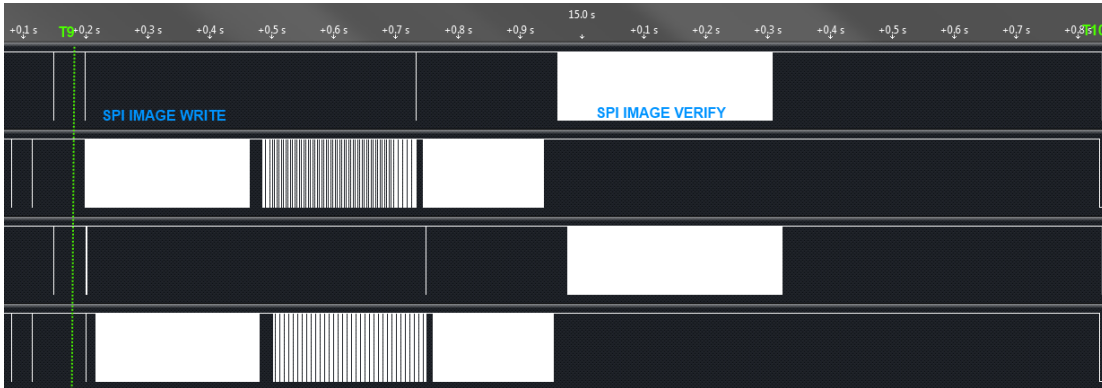
Step	Description
11 cont.	 <p>The diagram shows a timing sequence for Step 11 continuation. It features a top timeline with markers from -0.7 s to +0.4 s. A prominent feature is a blue-labeled '500 ms PULSE' in the DUT RX channel, occurring between approximately +0.1 s and +0.6 s. Other channels show various signal transitions and levels.</p>
T3	After the firmware version was acquired the XTAL Trim test begins. The 500 ms reference pulse in the DUT RX channel is shown with blue letters. This test lasted for 2.3 s including the UART resync.
T4	The RF RX RSSI test begins.
	 <p>The diagram for Step T4 shows a complex timing sequence. The top timeline has markers from -0.7 s to +0.8 s. Key operations are labeled: 'SPI ERASE' (around +0.1 s), 'SPI CHECK EMPTY' (around +0.2 s), and 'SPI IMAGE WRITE' (around +0.3 s). The DUT RX channel shows dense data patterns corresponding to these operations.</p>
T5	The firmware download (flash_programmer.bin) begins. Checking the log file the test lasted about 1.8 s. This can also be verified by looking the timing difference between T5-T4 at the first oscilloscope capture.
T6	PLT begins the operation to get the version of the flash_programmer.bin firmware.
T7	The SPI erase action begins. As with any SPI operation first a command to set the SPI bus pins is used and then the erase command. The blocks of data after the SPI erase and before the SPI check empty are SPI traffic on P0_5 which is the UART RX and the SPI MISO pin at the same time.
T8	The SPI check empty action begins. As with any SPI operation first a command to set the SPI bus pins is used and then the check empty command. The blocks of data after the SPI check empty and before the SPI image write are SPI traffic on P0_5 which is the UART RX and the SPI MISO pin at the same time.
	 <p>The diagram for Step T8 shows the final part of the timing sequence. The top timeline has markers from +0.1 s to +0.8 s. Key operations are labeled: 'SPI IMAGE WRITE' (around +0.2 s) and 'SPI IMAGE VERIFY' (around +0.5 s). The DUT RX channel shows data patterns for these operations.</p>

DA1458x/DA1468x Production Line Tool

Step	Description																															
11 cont.	<p>T9 The SPI image write operation begins. First the image will be written, as shown in the picture above, and then the contents are read back for verification. The blocks of data after the SPI image write and before the SPI image verification are SPI traffic on P0_5 which is the UART RX and the SPI MISO pin at the same time.</p>																															
	<p>T10 The PLT run has finished.</p> <table border="1"> <thead> <tr> <th>DUT</th> <th>BD Address</th> <th>Code</th> <th>Status</th> <th>Result</th> </tr> </thead> <tbody> <tr> <td>1</td> <td>00:00:55:00:00:01</td> <td>151</td> <td>SPI IMAGE WRITE OK</td> <td>PASS</td> </tr> <tr> <td>2</td> <td>00:00:55:00:00:02</td> <td>151</td> <td>SPI IMAGE WRITE OK</td> <td>PASS</td> </tr> </tbody> </table> <table border="1"> <thead> <tr> <th>GU</th> <th>COM Port</th> <th>Code</th> <th>Status</th> <th>Result</th> </tr> </thead> <tbody> <tr> <td></td> <td>COM119</td> <td>26</td> <td>RD TESTER INIT OK</td> <td>OK</td> </tr> </tbody> </table> <table border="1"> <thead> <tr> <th>BLE Tester</th> <th>Temp</th> <th>Voltmeter</th> </tr> </thead> <tbody> <tr> <td>NOT USED</td> <td>NOT USED</td> <td>NOT USED</td> </tr> </tbody> </table> <p>IC: DA14580</p> <p><input type="checkbox"/> COM Enum</p> <p><input type="checkbox"/> GU Check</p> <p><input type="checkbox"/> VBAT/JUART</p> <p><b>FINISHED</b></p> <p>C:\DA1458x_DA1468x_PLT_v_4.x\params\params.xml   Retest failed: Disabled   Test Time: 00:14:965</p>	DUT	BD Address	Code	Status	Result	1	00:00:55:00:00:01	151	SPI IMAGE WRITE OK	PASS	2	00:00:55:00:00:02	151	SPI IMAGE WRITE OK	PASS	GU	COM Port	Code	Status	Result		COM119	26	RD TESTER INIT OK	OK	BLE Tester	Temp	Voltmeter	NOT USED	NOT USED	NOT USED
DUT	BD Address	Code	Status	Result																												
1	00:00:55:00:00:01	151	SPI IMAGE WRITE OK	PASS																												
2	00:00:55:00:00:02	151	SPI IMAGE WRITE OK	PASS																												
GU	COM Port	Code	Status	Result																												
	COM119	26	RD TESTER INIT OK	OK																												
BLE Tester	Temp	Voltmeter																														
NOT USED	NOT USED	NOT USED																														
	<p>After the tests have finished, the log and CSV files are fully updated. The GUI PLT test counter on the bottom right of the screen indicates that the test took approximately 15 s. This is verified from both the log files and the CSV file. Both files are shown below.</p>																															
	<pre>Software: DA1458x/DA1468x Production Line Software version: v_4.1.0.132 PLTD DLL version: v_4.1.0.132 PDLL Version: v_4.1.0.132 UDLL Version: v_4.1.0.132 Production test BLE firmware version: v_5.0.4 Production test APP firmware version: v_5.0.4_PLT_v4.1 Flash programmer firmware version: v_5.0.4_PLT_v4.1 Date: 2017-08-11 Start Time: 17:32:31.403 End Time: 17:32:49.038 Station ID: Test_station_1 Device ID: 1 COM port: 184 BD address: 00:00:55:00:00:01</pre>																															

DA1458x/DA1468x Production Line Tool

Step	Description										
11 cont.		A	B	C	D		E	F	T1	G	
	1	Start time	End time	DUT	BD address		Overall status	COM port		FW download 1	
	2	18:54:14	18:54:29	1	00:00:55:00:00:01		PASS	25		PASS	
	3	18:54:14	18:54:29	2	00:00:55:00:00:02		PASS	26		PASS	
		H	T2	I	J	T3	K	L	T4	M	
		FW path 1		FW version get 1		FW version 1	XTAL trim test	XTAL trim	GU RX test 1		
		C:\Users\pd		PASS		v_5.0.4	PASS	1426		PASS	
		C:\Users\pd		PASS		v_5.0.4	PASS	1346		PASS	
		N	T5	O	P	T6	Q				
		GU RX RSSI 1		FW download 2		FW path 2	FW version get 2				
	-31.82		PASS		C:\Users\pd		PASS				
	-21.87		PASS		C:\Users\pd		PASS				
	R	T7	S	T8	T	T9	U	V	T10		
	FW version 2		SPI erase 1		SPI empty 1		SPI burn 1	SPI image 1			
	v_3.0.11.554		PASS		PASS		PASS	binaries\prox_reporte			
	v_3.0.11.554		PASS		PASS		PASS	binaries\prox_reporte			

Appendix A Top-view of PLT PCB Version D

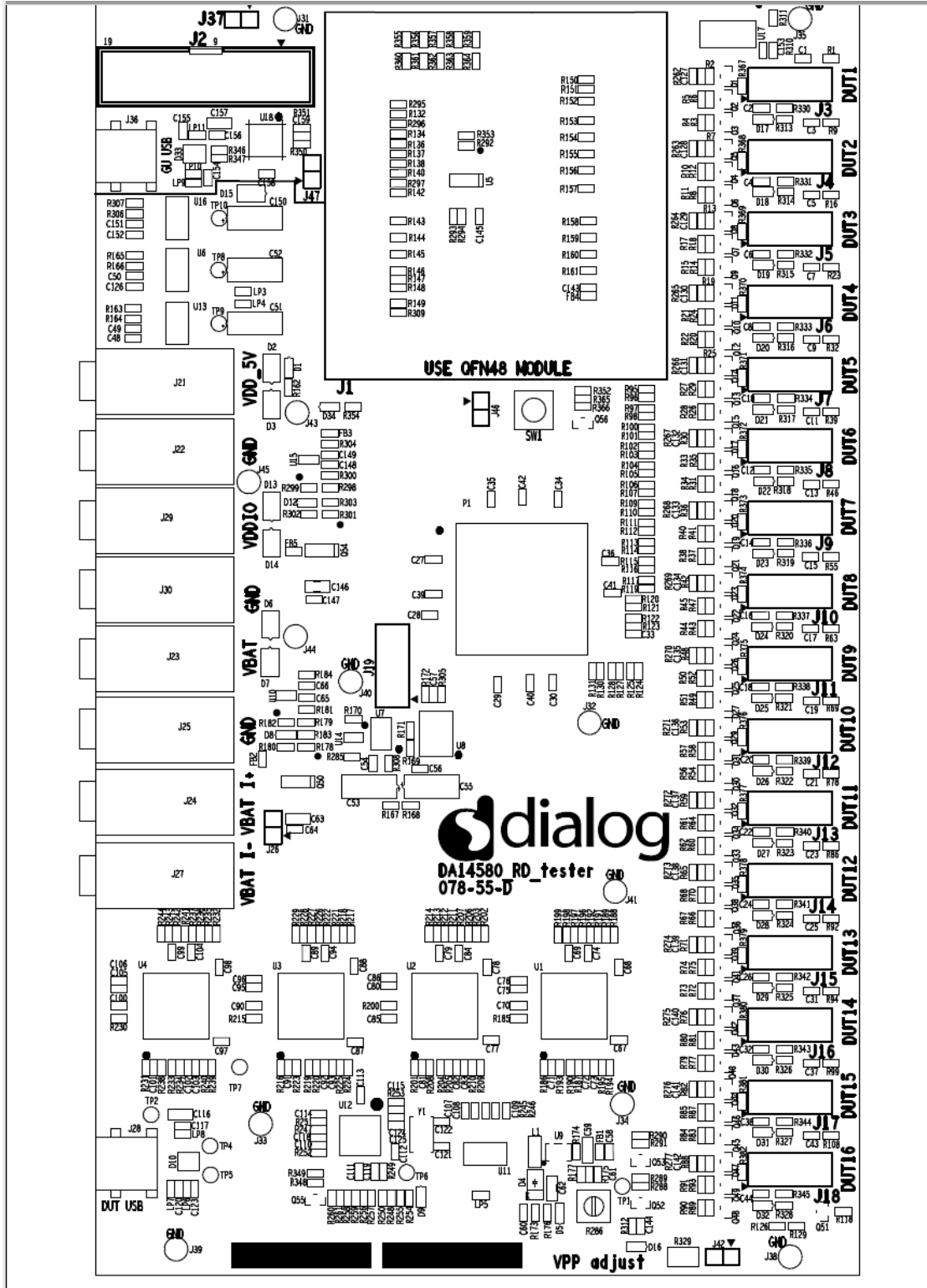

Figure 118: Top-view of PLT PCB Version D



Appendix B Electrical Schematics

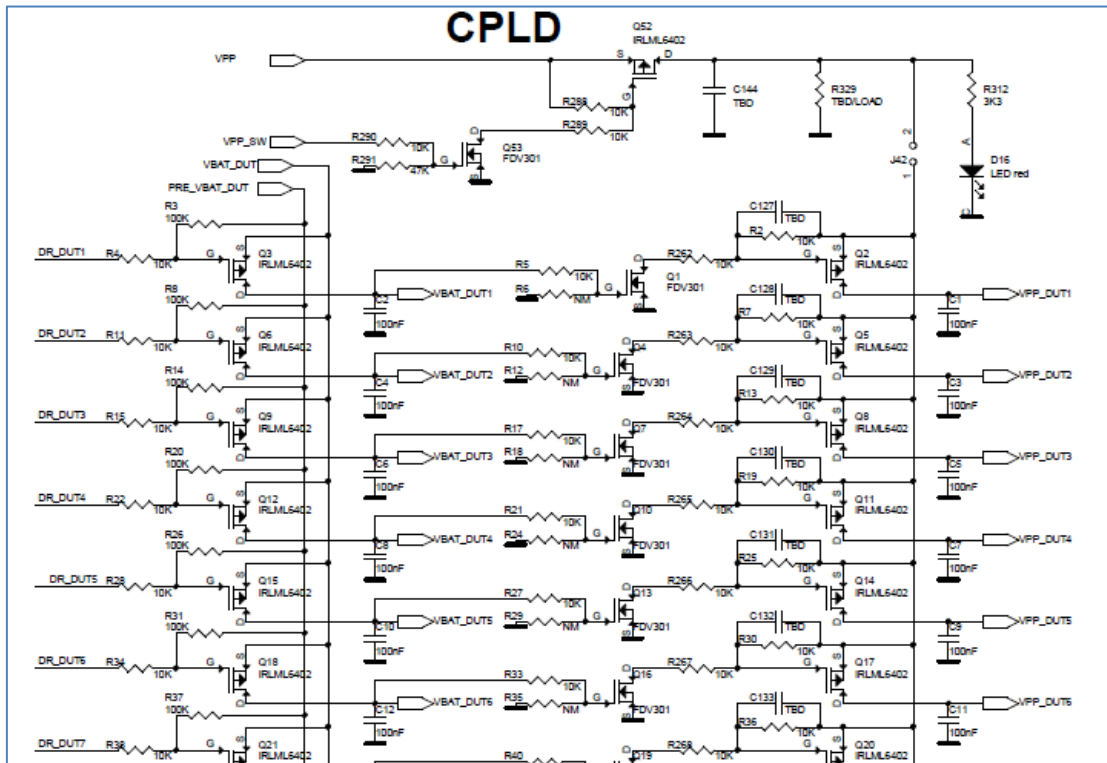

Figure 119: VBAT and VPP Control from CPLD

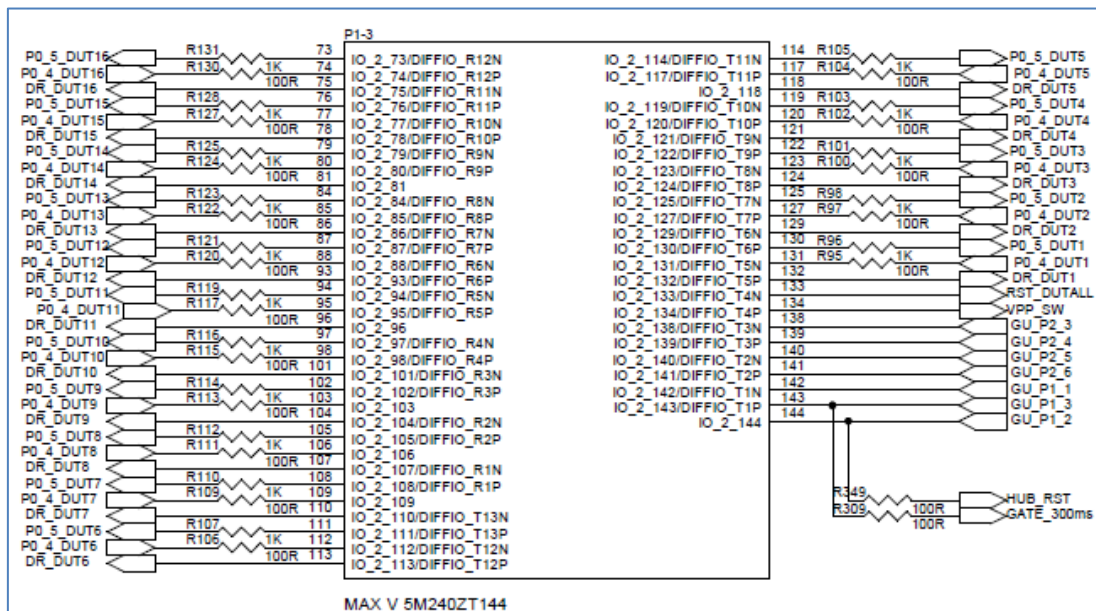

Figure 120: CPLD DUT UART Connections

### DA1458x/DA1468x Production Line Tool

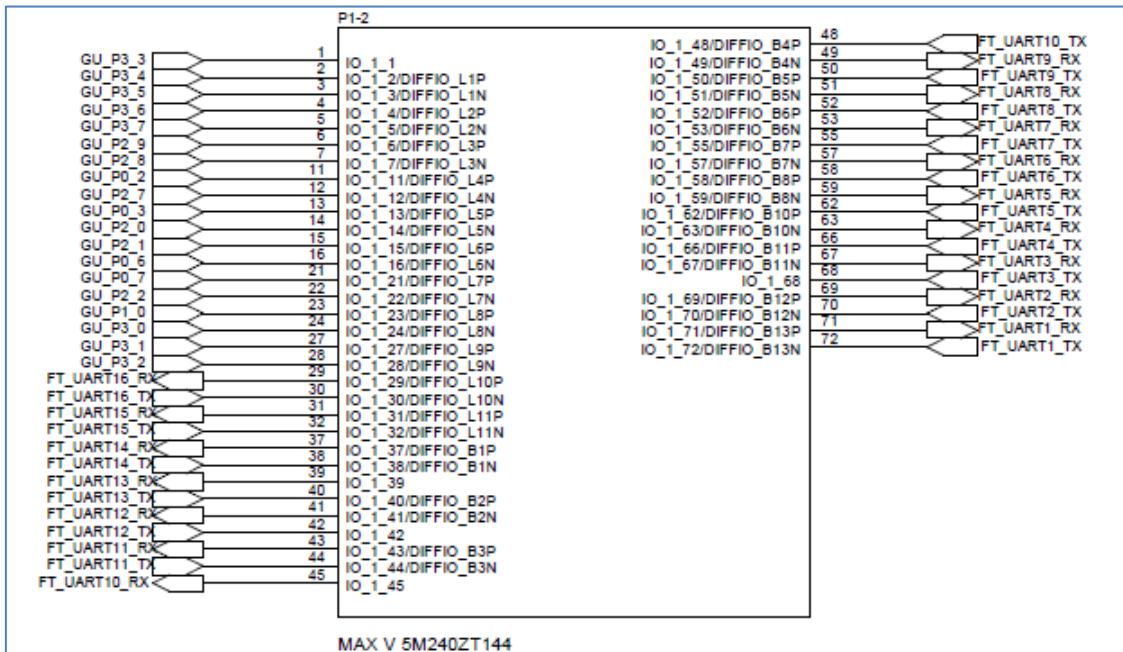

Figure 121: CPLD FTDI and GU Control Connections

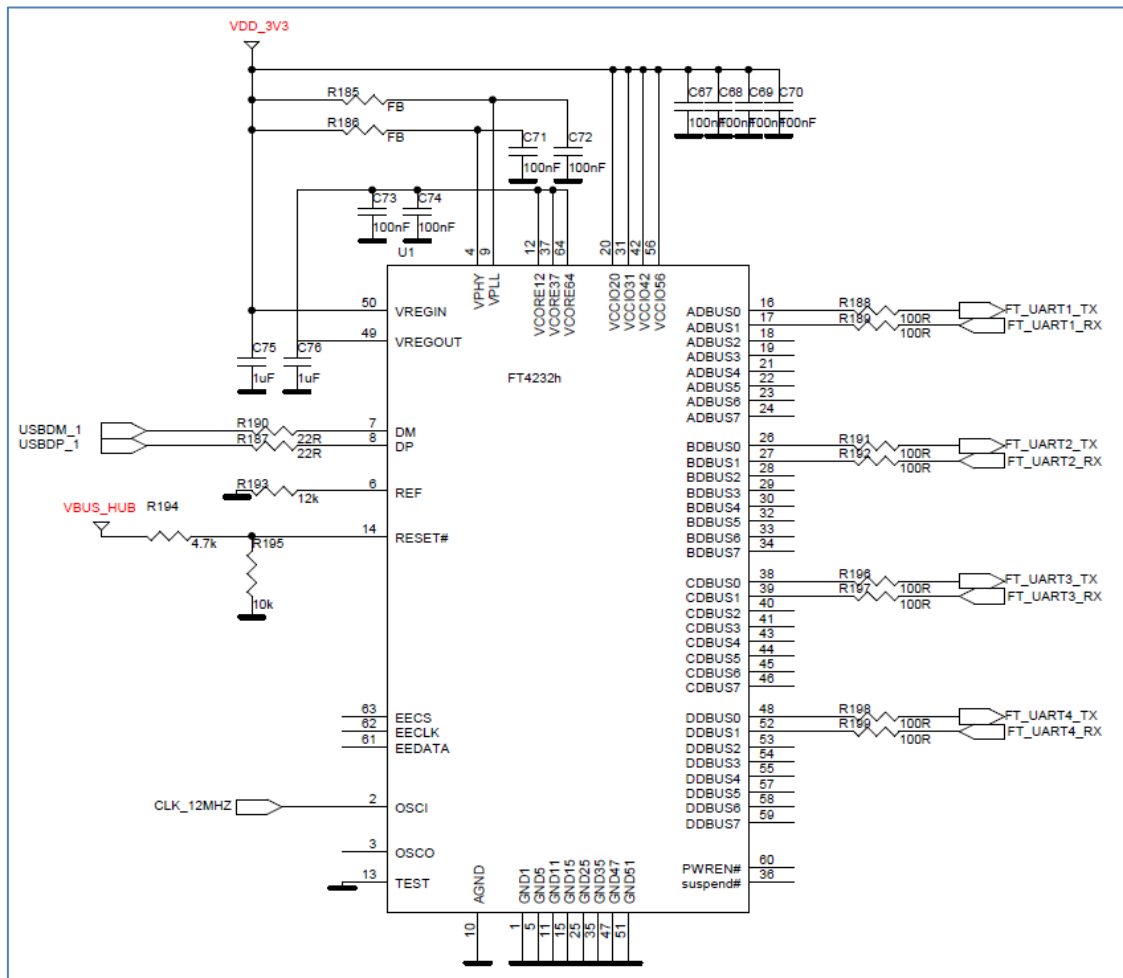

Figure 122: FTDI Chip for USB UART to DUTs 1, 2, 3 and 4



DA1458x/DA1468x Production Line Tool

USB HUB: provides 5 V input for the 3.3 V LDO and USB input-signals to the four Quad FTDI chips.

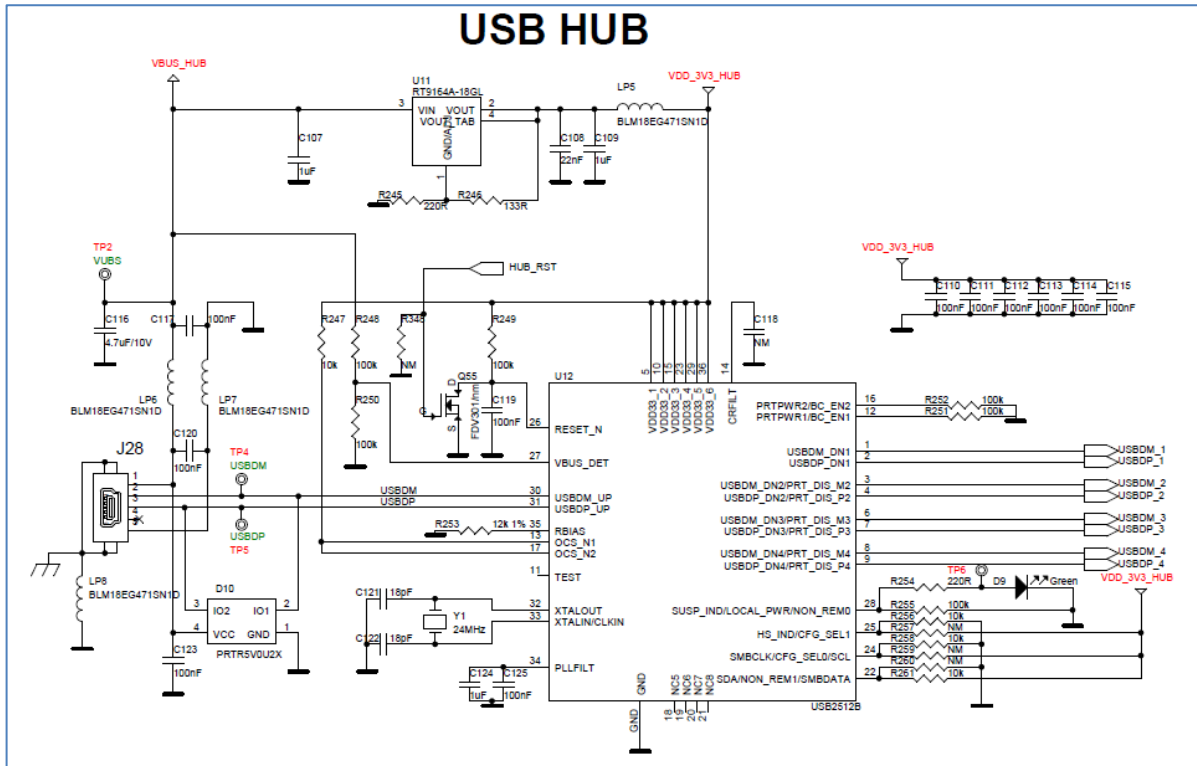

Figure 123: Quad USB HUB

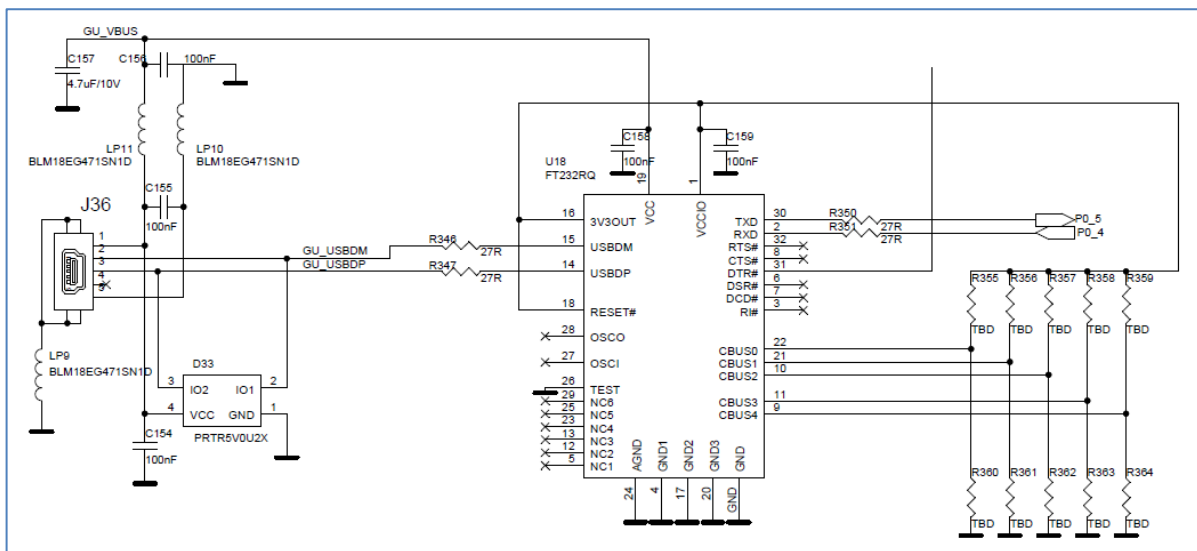

Figure 124: Golden Unit - Dedicated USB Port and FTDI Chip

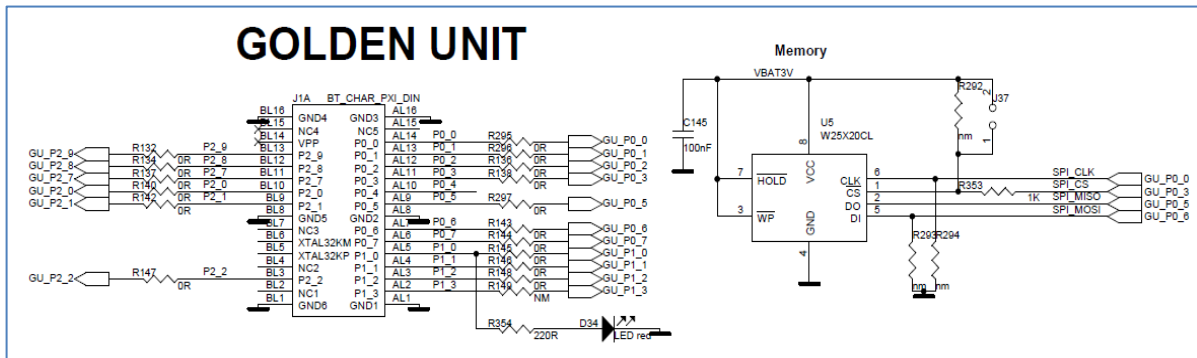

Figure 125: Golden Unit - GU LED and SPI Flash Memory

The Golden Unit SW (prod\_test\_GU.bin) is located in the SPI Flash memory mounted on the PLT hardware and is loaded into the GU's system RAM when powered on.

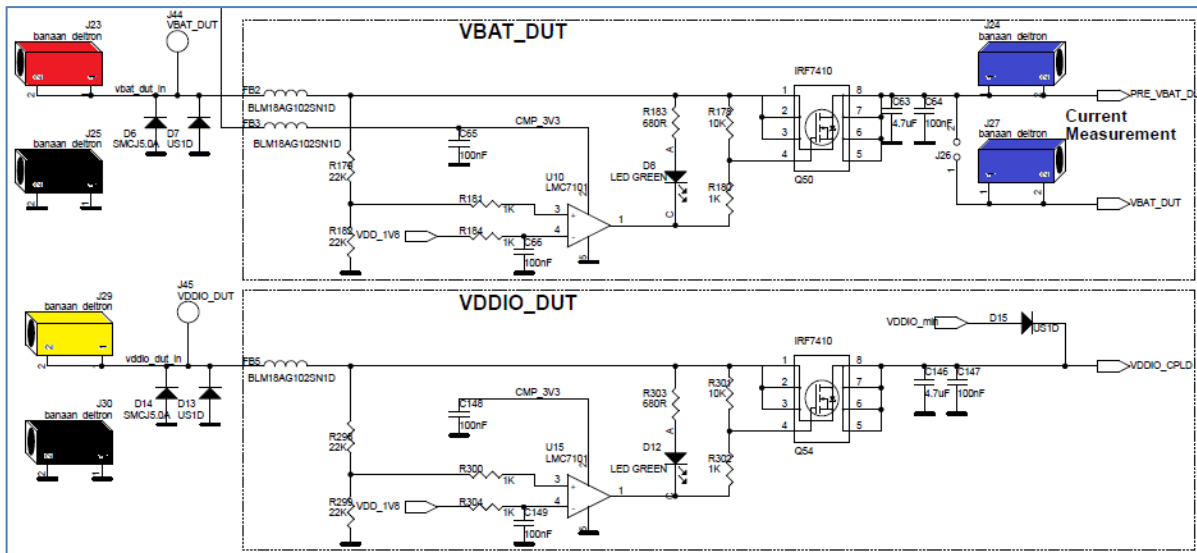

Figure 126: VBAT\_DUT and VDDIO Supplies

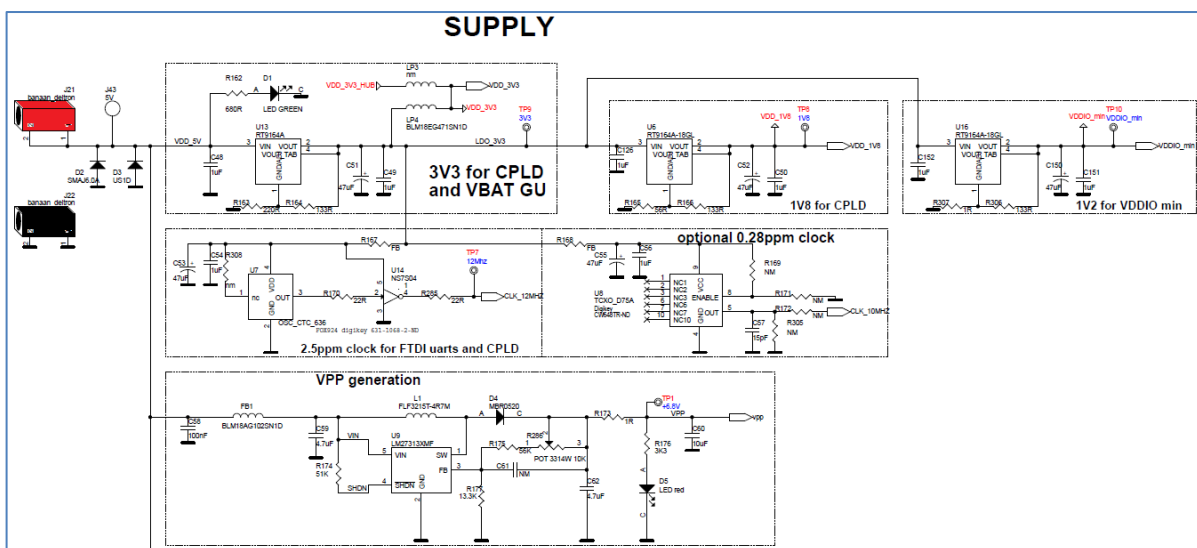

Figure 127: GU Supply and VPP Generation

### Appendix C Hardware Modifications PLT Version D

In the PLT hardware Version D a small modification was made. Resistor R365 (10 kΩ) and jumper J47 were added in series to the GU reset circuit.



Figure 128: DA14580\_RD\_tester Version D



Figure 129: Jumper J47 Added Next to Golden Unit Socket

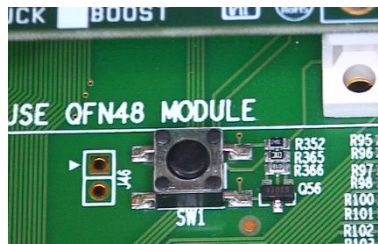

Figure 130: R365 (10 kΩ) Added Next to Reset Button

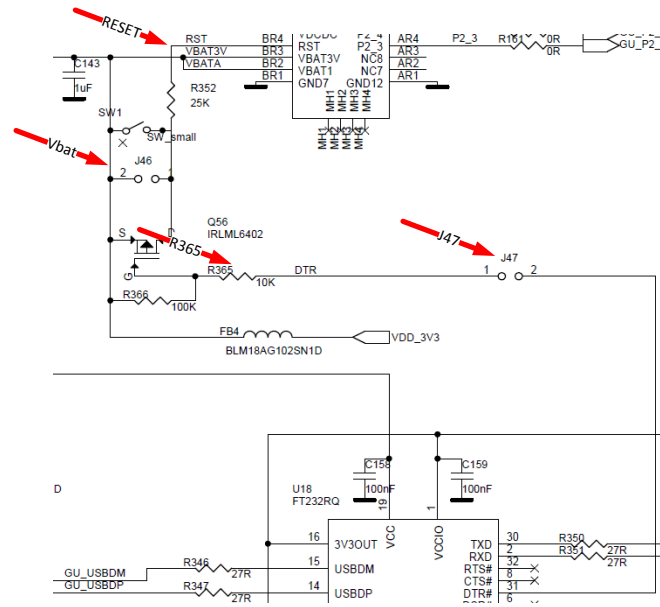
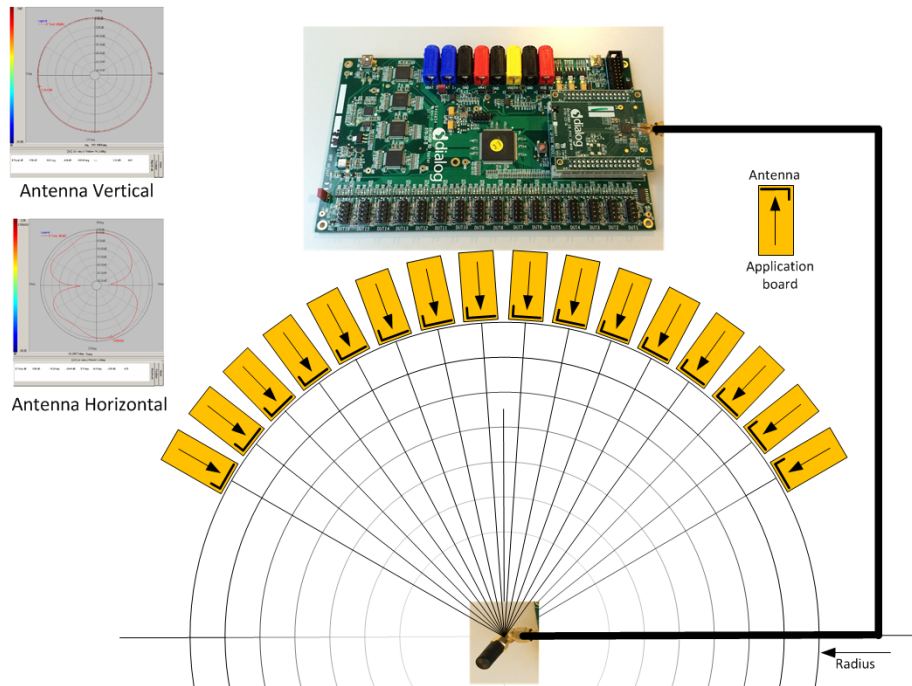

Figure 131: R365, J47 and RESET Shown in Electrical Schematic

## Appendix D Suggestions about Hardware and Cabling

When connecting the PLT to the DUTs special care should be taken with regard to the cabling.

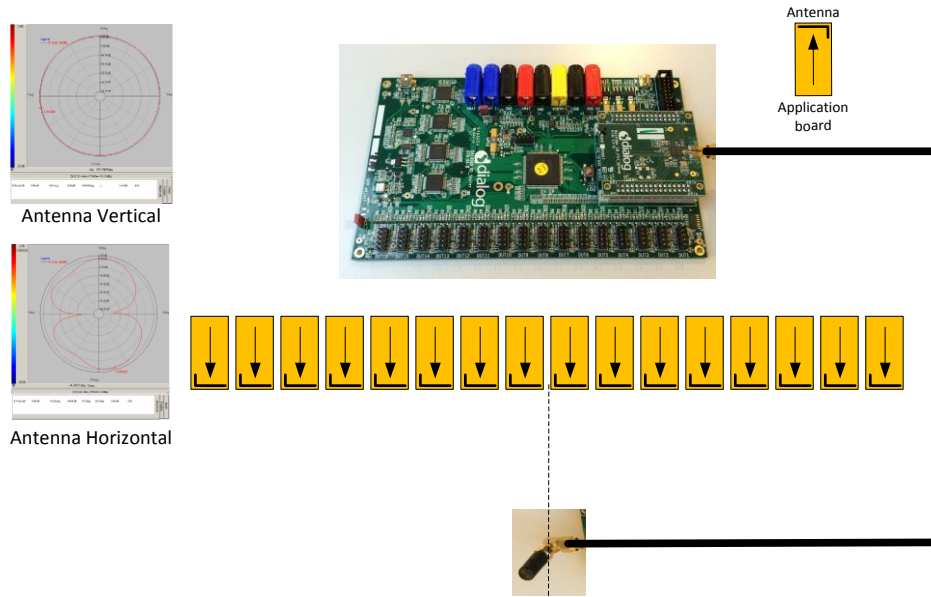

**Figure 132: Possible Solution of Antenna on Cable and Fixed Radius of DUTs to Antenna**

The user should realize that the PLT system is equipped with RF transmitters and receivers. These parts may induce noise on hardware and cables. The following aspects should be kept in mind:

- The direction of the GU antenna to the DUT antenna will influence the RSSI value.
- The distance of the DUT antenna to the GU antenna (radius) will influence the RSSI value.
- The control lines from the PLT to the DUTs must be kept as short as possible.
- A vertical GU antenna has different characteristics from a horizontal one. See [Figure 132](#).

### DA1458x/DA1468x Production Line Tool



**Figure 133: Possible Solution of Antenna on Cable and DUTs Put in Line**

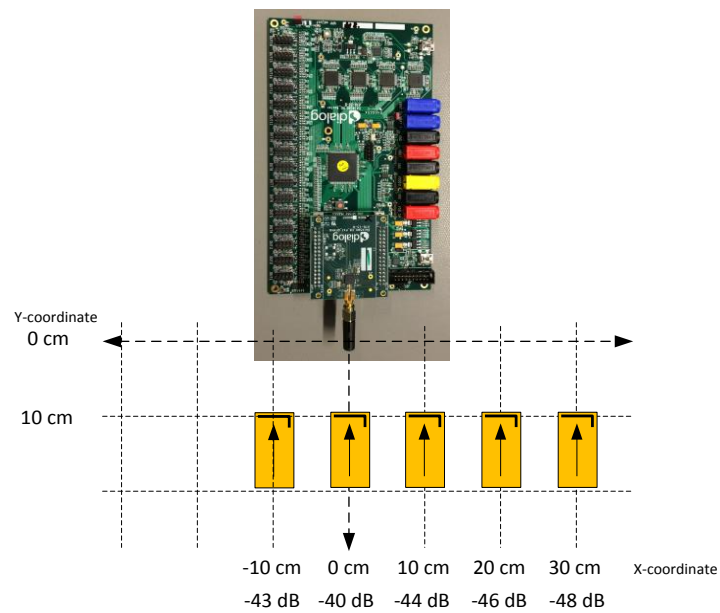

**Figure 134: Example Locations and RSSI Readouts of Horizontal Antenna**

Figure 134 shows the measured values from Table 97.

**Table 97: RF Test RSSI Results**

Test	Distance (cm)	Offset (cm)	RSSI (dBm)	Description
1	10	0	-40	DUT and GU boards are inline.
2	10	-10	-43	DUT moved 10 cm to the left relative to the GU.
3	10	10	-44	DUT moved 10 cm to the right relative to the GU.
4	10	20	-46	DUT moved 20 cm to the right relative to the GU.
5	10	30	-48	DUT moved 30 cm to the right relative to the GU.
6	10	normal	-40	DUT and GU boards are inline, functioning normally.

**DA1458x/DA1468x Production Line Tool**

Test	Distance (cm)	Offset (cm)	RSSI (dBm)	Description
7	10	defect 1	-60 ~ -70	Coupling capacitor not soldered well, missing or damaged.
8	10	defect 2	~ -60	Short circuited shunt matching inductor (e.g. solder bridge)
9	10	defect 3	< -100	16 MHz crystal oscillator not working well. Received packets ~ 0.
Golden Unit output power = 0 dBm				

For more details on the RF setup refer to [\[12\]](#).

## Appendix E Hex2Bin

This section gives a step-by-step example of using the `hex2bin.exe` utility, which converts Intel HEX files into binary format. See [Figure 136](#).

1. Put the `hex2bin.exe` file in same directory as the HEX files to be converted.
2. Open a Command Line Interface (CLI) in the same directory, e.g. by using `<Shift>+<Right Click>` and selecting 'Open command window here'.
3. Enter `hex2bin -c blinky_1.hex`.
4. The binary file (`blinky_1.bin`) will be produced in the same directory.

[Figure 135](#) shows the directory and the files used in this example.

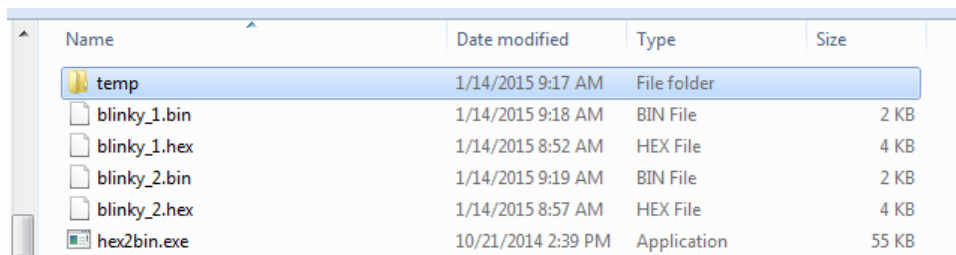

Name	Date modified	Type	Size
temp	1/14/2015 9:17 AM	File folder	
blinky_1.bin	1/14/2015 9:18 AM	BIN File	2 KB
blinky_1.hex	1/14/2015 8:52 AM	HEX File	4 KB
blinky_2.bin	1/14/2015 9:19 AM	BIN File	2 KB
blinky_2.hex	1/14/2015 8:57 AM	HEX File	4 KB
hex2bin.exe	10/21/2014 2:39 PM	Application	55 KB

**Figure 135: Hex2Bin Example Directory with Files**



DA1458x/DA1468x Production Line Tool

```

C:\WINDOWS\system32\cmd.exe
usage: hex2bin [OPTIONS] filename
Options:
-s [address] Starting address in hex (default: 0)
-l [length] Maximal Length (Starting address + Length -1 is Max Address)
             File will be filled with Pattern until Max Address is reached
             Length must be a power of 2 in hexadecimal:
             Hex      Decimal
             1000    =    4096  (4ki)
             2000    =    8192  (8ki)
             4000    =   16384 (16ki)
             8000    =   32768 (32ki)
            10000    =   65536 (64ki)
            20000    =  131072 (128ki)
            40000    =  262144 (256ki)
            80000    =  524288 (512ki)
           100000    = 1048576 (1Mi)
           200000    = 2097152 (2Mi)
           400000    = 4194304 (4Mi)
           800000    = 8388608 (8Mi)
-e [ext] Output filename extension (without the dot)
-c Enable hex file checksum verification
-p [value] Pad-byte value in hex (default: ff)
-k [0|1|2] Select checksum type
            0 = 8-bit,
            1 = 16-bit little endian,
            2 = 16-bit big endian
-r [start] [end] Range to compute checksum over (default is min and max addresses)
-f [address] [value] Address and value of checksum to force

C:\_hex2bin>hex2bin -c blinky_1.hex
hex2bin v1.0.10, Copyright (C) 2012 Jacques Pelletier & contributors
Lowest address = 00000000
Highest address = 00000447
Pad Byte = FF
8-bit Checksum = 33

C:\_hex2bin>hex2bin -c blinky_2.hex
hex2bin v1.0.10, Copyright (C) 2012 Jacques Pelletier & contributors
Lowest address = 00000000
Highest address = 00000477
Pad Byte = FF
8-bit Checksum = D8

C:\_hex2bin>cd _hex2bin_
    
```

Figure 136: Hex2Bin.exe Example

## Appendix F Bin2Image

Figure 138 shows an example of using the `bin2image.exe` utility, which creates a bootable cached image for DA1468x devices.

The file `bin2image.exe` must be put in the same directory as the file to be converted. Figure 137 shows the directory and the files used in this example.

Name	Date modified	Type	Size
temp	7/27/2016 8:54 PM	File folder	
bin2image.exe	5/17/2016 9:53 PM	Application	44 KB
pxp_reporter.bin	10/16/2015 5:19 PM	BIN File	57 KB
pxp_reporter.bin.cached	7/27/2016 8:54 PM	CACHED File	57 KB

Figure 137: Bin2Image Example Directory with Files

```

C:\WINDOWS\system32\cmd.exe
C:\_Test>bin2image ?
Version: 1.8

bin2image type binary_file image_file [ AD [enable_uart] [ram_shuffling] ]

Convert the executable binary file 'binary_file' to a
bootable image file 'image_file'.
The 'type' argument defines what kind of image to be
generated:
  qspi_cached      QSPI flash image for cached mode (production & development paths)
  qspi_mirrored    QSPI flash image for mirrored mode (production path only)
  qspi_single_mirrored QSPI flash image for mirrored mode (development path only, qspi operating in single mode)
  otp_cached       OTP image for cached mode
  otp_mirrored     OTP image for mirrored mode

If argument 'AD' is passed, it commands the generation of
an image for version AD of the chip, whose header is 16
bytes long, instead of 8.
If 'AD' is passed:
- 'enable_uart' can be used to enable UART during boot
  (the default is not to enable it)
- 'ram_shuffling' can take value 0, 1, 2, or 3 to
  configure the DataRAM cell shuffling:
  0: 8 - 24 - 32 (default)
  1: 24 - 8 - 32
  2: 32 - 8 - 24
  3: 32 - 24 - 8

Note: For cached mode images, the MSBit of the length is set to 1

C:\_Test>bin2image qspi_cached pxp_reporter.bin pxp_reporter.bin.cached AD enable_uart
C:\_Test>
  
```

Figure 138: Bin2Image Example

## Appendix G Automatic GU COM Port Find

For the GU COM port automatic recognition to operate a special serial number should exist in the GU FTDI IC. Usually this serial number is programmed during PLT PCB manufacturing, but it may not exist in some older versions.

If the 'GU COM port find' operation does not work, then the steps described in should be followed.

**Table 98: FTDI "DialogSemi" Serial Number**

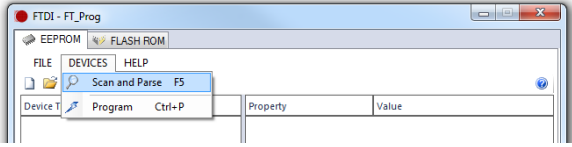
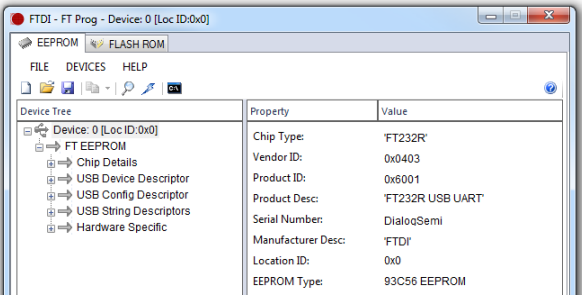
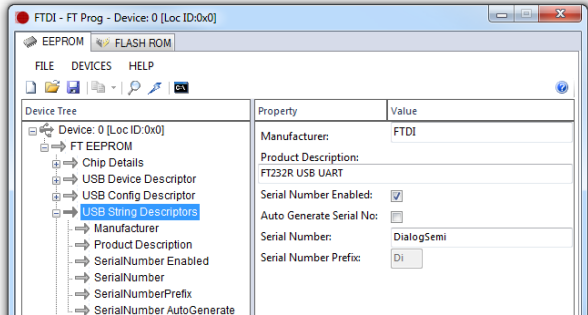
Step	Description
1	Download the FTDI FT_Prog tool from <a href="http://www.ftdichip.com/Support/Utilities.htm#FT_PROG">http://www.ftdichip.com/Support/Utilities.htm#FT_PROG</a> .
2	Put power on the PLT board.
3	Remove any other USB FTDI connection to the PC.
4	Connect the USB cable of the GU to the PC.
5	Check the Device Manager that the GU COM port has been found.
6	Run the FT_Prog.exe. 
7	Select 'Devices > Scan and Parse'. 
8	A single 'FT232' device should be found. 
9	Select 'USB String Descriptors'.
10	Uncheck the 'Auto Generate Serial No:'.
11	Edit 'Serial Number' to "DialogSemi" as shown below. 

DA1458x/DA1468x Production Line Tool

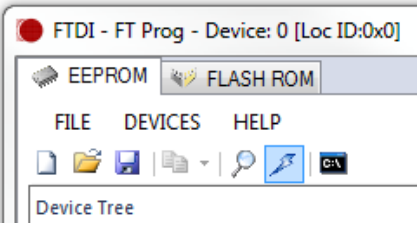
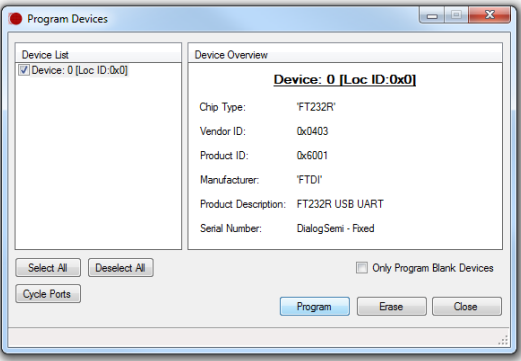
Step	Description
12	<p>Press the 'Flash' button to program the change to the FTDI IC.</p> 
13	<p>Press 'Program' in the new window.</p> 
14	Press 'Close'.
15	Unplug and reconnect the GU USB cable to the PC.
16	Verify the Serial Number change by running FT_Prog.exe again and reading the Serial Number value.

## Appendix H Improving Cabling between PLT and DUTs

The following recommendations can be used to improve the connections between PLT and DUTs:

- Keep the lengths of the cables as short as possible.
- When possible use twisted pair cables instead of separate cables for:
  - GND/VBAT
  - GND/TxD
  - GND/RxD
  - GND/VPP
- Use ferrite beads for noise reduction in cables.

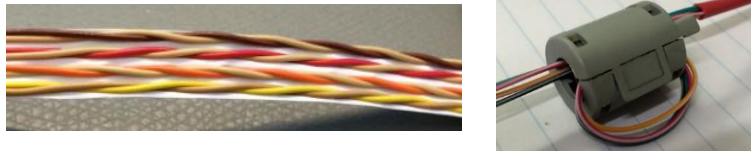
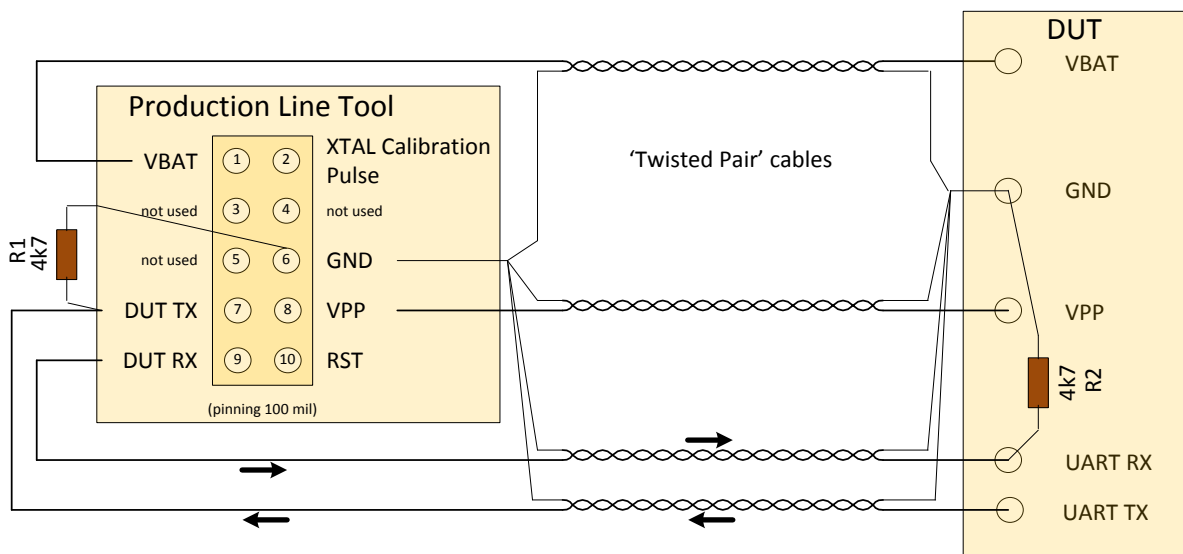

**Figure 139: Example of Twisted Pair Cable with 4 Pairs and Ferrite**

- Connect pull-down resistors at the end of the PLT TX signal lines. Use a 4.7 kΩ resistor at PLT DUT Connector Pin 7 (DUT TX) with the other end connected to ground. In total 16 resistors must be mounted, one for each PLT DUT connector.
- Connect a pull-down resistor as close as possible to the UART RX signal connector on the DUT. The value should be approximately 4.7 kΩ. Connect the other end of the resistor to ground.
- Use gold plated contacts in the connections between the PLT and the DUTs.
- Use extra drivers in the UART lines.
- Use series resistors of approximately 100 Ω in the UART lines, one mounted at the beginning and one at the end of the signal lines.

**Note:** Start with the simple solutions first by testing them one-by-one for stability.

Figure 140 and Figure 141 show examples of some of the above proposals.



**Figure 140: Location of Pull-Down Resistors**

DA1458x/DA1468x Production Line Tool

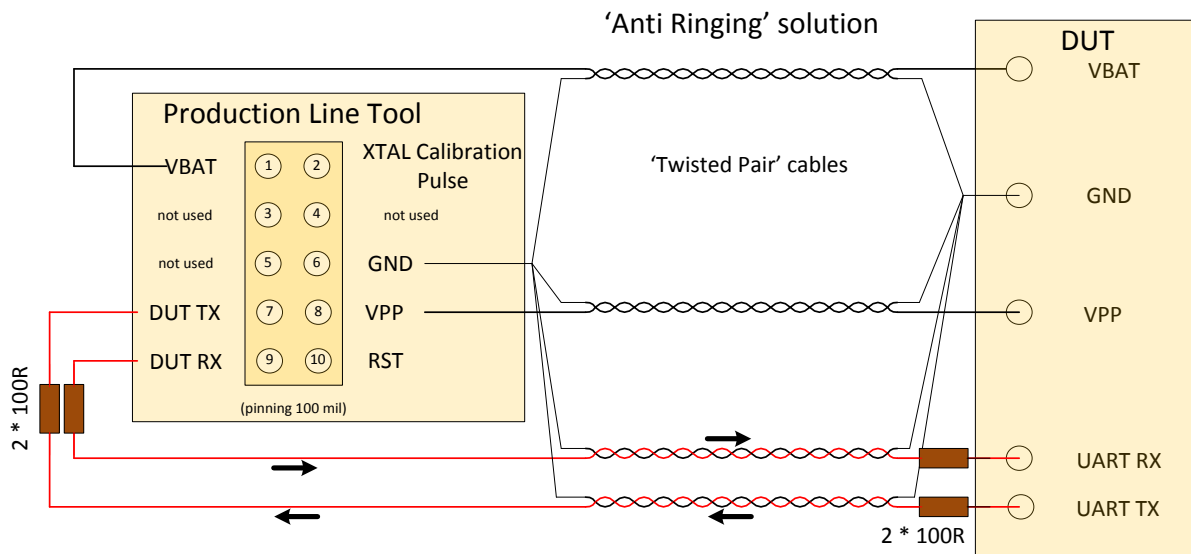

Figure 141: Anti-Ringing Solution

Appendix I Settings for DA14583 Internal SPI Flash Memory

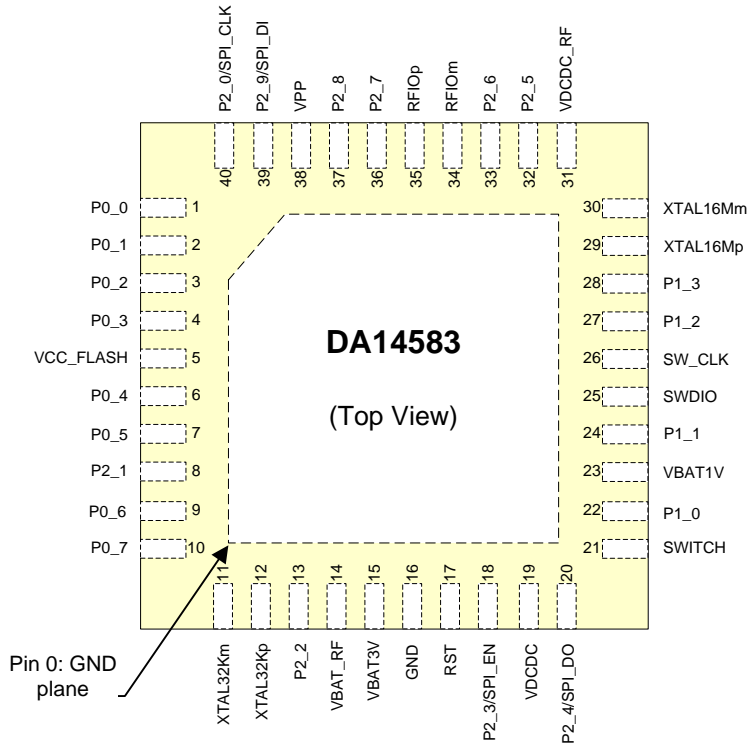

Figure 142: Pin Assignment of DA14583 - QFN40

Table 99: DA14583 Internal SPI Flash Connections

DA14583 Pin	SPI Function	Description
P2_0	SPI_CLK	SPI Clock
P2_9	SPI_DI	MOSI
P2_4	SPI_DO	MISO
P2_3	SPI_EN	SPI Chip Select



## Appendix J Settings for DA14586 Internal SPI Flash Memory

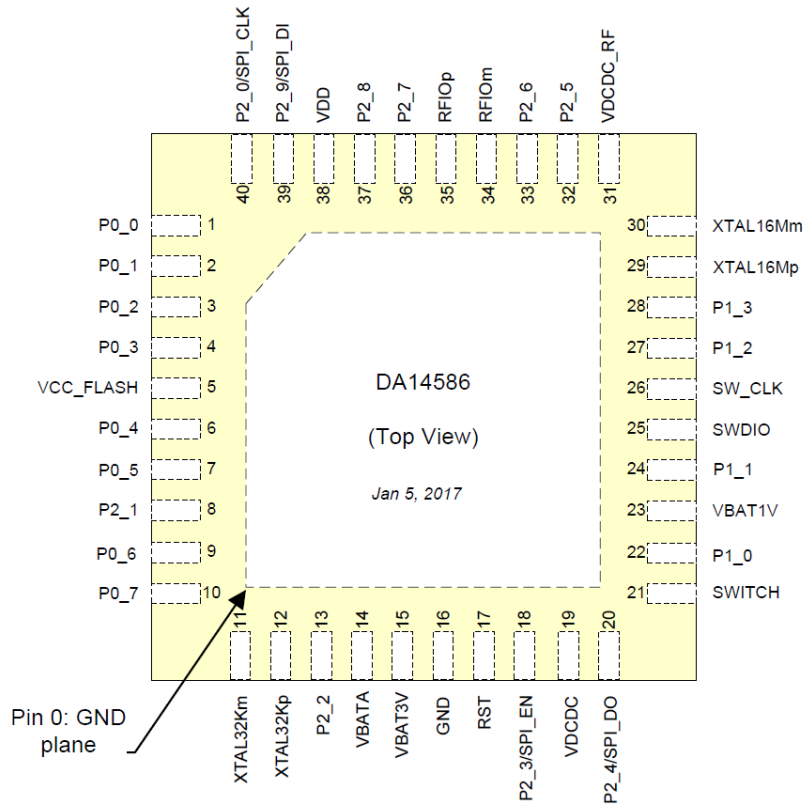

Figure 143: Pin Assignment of DA14586 - QFN40

Table 100: DA14586 Internal SPI Flash Connections

DA14586 Pin	SPI Function	Description
P2_0	SPI_CLK	SPI Clock
P2_9	SPI_DI	MOSI
P2_4	SPI_DO	MISO
P2_3	SPI_EN	SPI Chip Select

## **Appendix K Honeywell Xenon 1900 Barcode Scanner Setup**

In order to use the Honeywell Xenon 1900 then please follow the steps below to appropriate set it up for PLT usage:

1. Download Xenon-UG.pdf User Guide.
2. Scan Restore factory defaults at page 198 (Resetting the Factory Defaults)
3. Program the USB to Serial Interface. Scan code at Page 32 (TRMUSB130)
4. Download Xenon USB to Serial drivers HSM USB Serial Driver version 3.5.5.zip

## Appendix L Program the Golden Unit SPI Flash Memory

The SPI Flash memory of the Golden Unit can be programmed as any DA14580 device, using the JTAG connector next to the Golden Unit and the Smart Snippets Toolbox application.

1. Connect the power supply to the Rd tester board as described in [PLT Power Supply](#).
2. Connect the USB cable of the Golden Unit.
3. Connect the JTAG (J2) of the Golden Unit.
4. Open the Smart Snippets Toolbox and select the JTAG method and the DA14580 chip.
5. Under the “Layout” category, on the “Booter & Board Setup page”, the GPIOs for the Flash memory should be the following: CLK: P0\_0, CS: P0\_3, MISO: P0\_5, MOSI: P0\_6.
6. Under the “Tools” category, on the “SPI Flash Programmer” tab, using the “Browse” button, select the “prod\_test\_GU.bin” binary which is under the DA1458x\_DA1468x\_PLT\_v4.x/binaries/GU/prod\_test\_GU.bin folder on the PLT software package.
7. After the binary is loaded on the Smart Snippets Toolbox, press “Connect” at the bottom. This will download a firmware on the Golden Unit and set the SPI Flash GPIOs to program the memory.
8. Select “Erase” to completely erase the Flash memory before burning the new firmware.
9. Select “Burn and Verify”. On the pop-up message select to make the firmware bootable.
10. Remove the JTAG from the Rd tester board and then manually reset the Golden Unit using the reset button next to it. The Golden Unit has now booted with the new firmware.

## Appendix M Connecting a Speaker to the Golden Unit for Audio Test

PLT is able to perform audio test for the DA1582, DA14585 and DA14586 devices. The audio test settings are described in [Audio Test](#). A speaker can be connected to the Golden Unit using GPIOs P1\_0 (AL4) and P1\_1 (AL5) as shown in [Figure 144](#) to generate the 4 kHz tone.



**Figure 144: Speaker Connection for Audio Test.**

## Appendix N FTDI Driver Removal and Installation

In order to re-install the latest FTDI drivers, the previous should be uninstalled.

FTDI driver removal:

1. Download CDM uninstaller from <http://www.ftdichip.com/Support/Utilities.htm#CDMUninstaller>.
2. Plug both USB cables of the PLT HW and wait for Windows to identify the COM ports. Wait until Windows complete the driver installation (even with a failure).
3. Run `CDMuninstallerGUI.exe`
4. The VID/PID of the PLT FTDIs are VID=0403/PID=6011 for the DUTs and VID=0403/PID=6001 for the GU.  
Enter these VIDs and PIDs in the CDM Uninstaller and press add for each one.
5. Then press `Remove Devices` to uninstall the FTDI drivers.
6. Un-plug both USB cables.

FTDI driver installation:

1. Download the latest drivers from <http://www.ftdichip.com/Drivers/VCP.htm> and install them using the executable.
2. After uninstalling the drivers, plug in both USB cables. Windows will automatically assign the new drivers. Do not remove the cables during driver installation. A driver installation error may occur and the removal-installation will have to be repeated.
3. Check in the Windows Device manager that now the driver version of the 17 PLT COM Ports->USB Serial Ports (COMx) is the latest.

FTDI driver versions v2.12.24, v2.12.26 and 2.12.28 have been tested.

## Appendix O DA1458x DK PRO Motherboard Connection

Figure 145 shows the wiring to a Pro DK motherboard for the DA14580/1/2/3/5/6 DUTs.

As described in [DUT Connector](#) the following connections are needed to connect a DUT to the PLT:

1. Ground. DUT connector pin6 <-> Pro DK J5 pin2.
2. VBAT. DUT connector pin1 <-> Pro DK J5 pin1.
3. UART Tx. DUT connector pin7 <-> Pro DK J5 pin11.
4. UART Rx. DUT connector pin9 <-> Pro DK J5 pin13.
5. Reset. DUT connector pin10 <-> Solder to Reset button (SW1) (Optional).

**Note:** If no power supply is provided through the USB cable (J12), the reset circuit will drive the reset pin of the DUT host board (connector J4) high, keeping the DUT at a reset state. To overcome this either the R84 resistor should be removed or the USB cable should be connected.

**Note:** J11 jumper should be removed. Power supply will be provided from the PLT HW (VBAT line).

**Note:** To use the onboard SPI flash memory the J5 jumper configuration should be as shown on the silkscreen PCB print (left of J5). A triple jumper must be used to connect the P0\_5 (J5 – pin13) with the SPI MISO (J6 – pin2) and the PLT UART-Rx pin (on DUT connector – pin9).

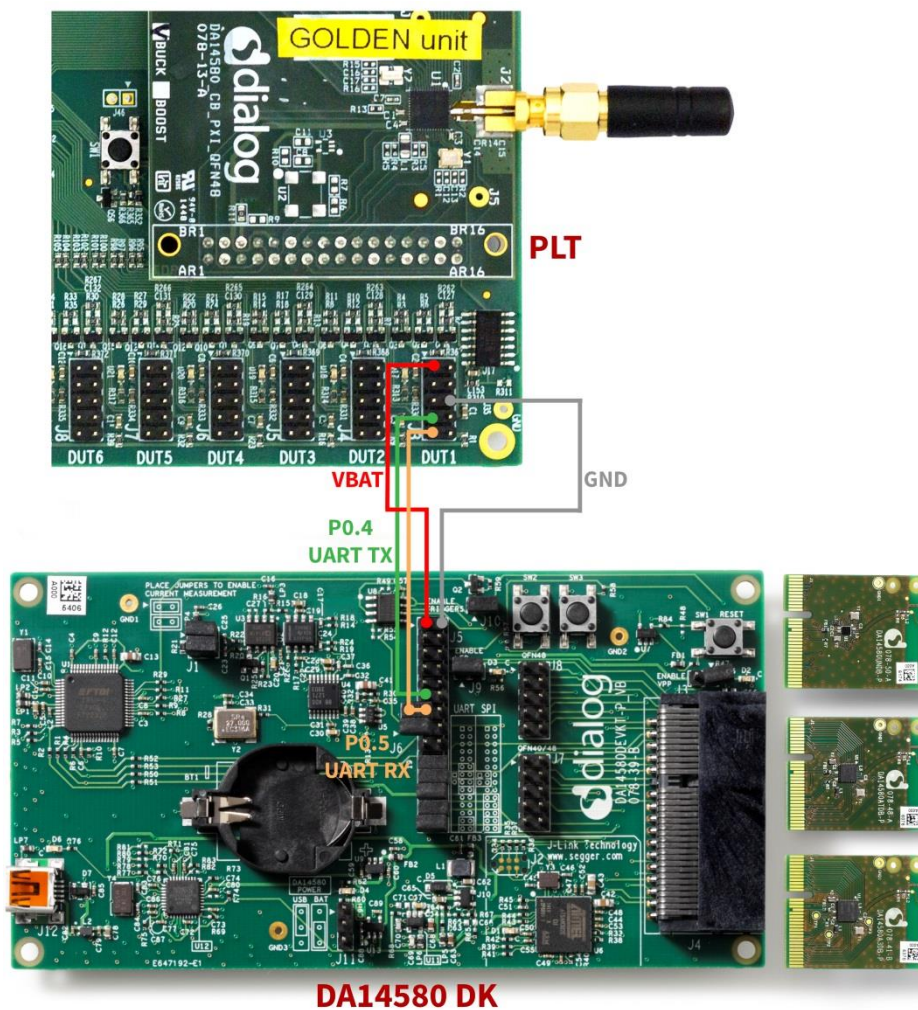

Figure 145: DA14580/5 Pro Motherboard DK Wiring.



## Appendix P DA1468x DK PRO Motherboard Connection

Figure 146 shows the wiring to a Pro DK motherboard for the DA14680/1/2/3 DUTs.

As described in [DUT Connector](#) the following connections are needed to connect a DUT to the PLT:

1. Ground. DUT connector pin6 <-> Pro DK J3 pin22.
2. VBAT. DUT connector pin1 <-> Pro DK J3 pin24.
3. UART Tx. DUT connector pin7 <-> Pro DK J4 pin8.
4. UART Rx. DUT connector pin9 <-> Pro DK J3 pin19.
5. Reset. DUT connector pin10 <-> Solder to Reset button (K2) (Optional).

**Note:** All jumpers must be removed. Power supply will be provided from the PLT HW (VBAT line).

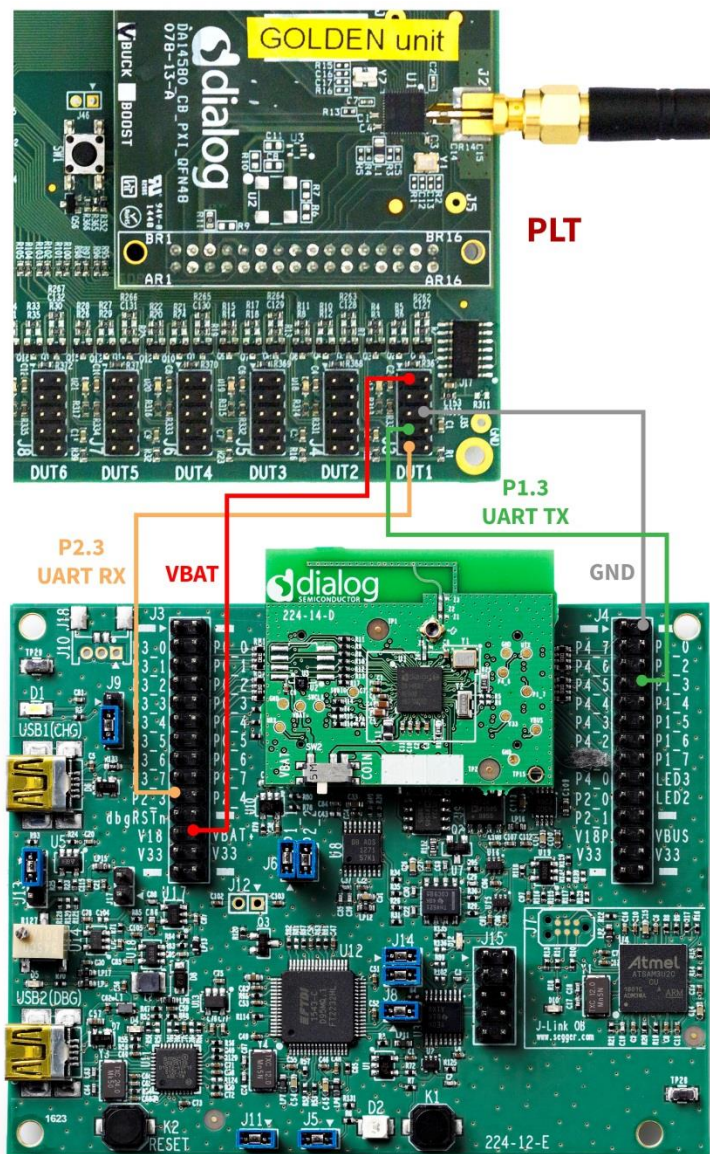

Figure 146: DA14680/1/2/3 Pro Motherboard DK Wiring.

## Appendix Q Connecting DUT with Battery Supply

Wiring connections to a battery powered DUT is described in [DUT Connector](#) and chapters [DA1458x DK PRO Motherboard Connection](#) and [DA1468x DK PRO Motherboard Connection](#) can be taken as an example but there are some limitations.

1. Four wires are mandatory for the connection:

- Common Ground
- UART Tx
- UART Rx
- Reset line

**Note:** In order to have the least possible wiring connections, UART Rx line can also be used as input GPIO for the pulse used during the XTAL Trim procedure as described in [XTAL Trim](#) and [XTAL Trim](#).

2. [VBAT as Reset](#) mode is the only mode supporting battery powered DUTs since POR cannot be performed. In order for the PLT to perform a reset on the DUTs, the VBAT line of each DUT connector must be connected to the reset line of the DUT as described in [VBAT as Reset](#) mode.
3. Current measurement is not supported, since there is no way to measure the current of the DUTs.
4. In order to program the OTP for the DA14580/1/2/3 DUTs an external VPP voltage must be supplied. VPP lines on the DUT connectors will not provide any voltage in [VBAT as Reset](#) mode so they cannot be used.



## Appendix R DUT Status Codes

Table 101 contains all the possible status codes a DUT can have, followed by a brief description. The table categorizes the status based on the various states of the DUT during testing and programming.

**Table 101: DUT Status Codes**

Status	Description
<b>Generic</b>	
DUT NOT ACTIVE	Device is not active.
DUT INTERNAL SYSTEM ERROR	Internal system error.
DUT COM PORT IDENTIFY STARTED	COM port identification started.
DUT COM PORT IDENTIFY OK	COM port identified successfully.
DUT COM PORT IDENTIFY FAILED	COM port identification failed.
DUT GU ERROR	Error occurred due to a Golden Unit failure. Check the Golden unit status for more information.
<b>COM port enumeration</b>	
DUT PDLL UART LOOP INIT	UART loop test initialized.
DUT PDLL UART LOOP START	UART loop test start.
DUT PDLL UART LOOP OK	UART loop test ended successfully.
DUT PDLL UART LOOP FAILED	UART loop test failed.
<b>Temperature measurement</b>	
DUT TEMPERATURE MEASUREMENT INIT	Temperature measurement initialized.
DUT TEMPERATURE MEASUREMENT OK	Temperature measurement finished successfully.
DUT TEMPERATURE MEASUREMENT ERROR	Temperature measurement error.
<b>Production test - Generic errors</b>	
DUT PDLL NO ERROR	PDLL returned success.
DUT PDLL PARAMS ERROR	PDLL Device parameters contain errors.
DUT PDLL RX TIMEOUT	Device did not reply on a PDLL message request.
DUT PDLL TX TIMEOUT	Sending a message to the device failed due to Tx timeout.
DUT PDLL UNEXPECTED EVENT	Received an unexpected message from the device.
DUT PDLL CANNOT ALLOCATE MEMORY	PDLL cannot allocate memory.
DUT PDLL INTERNAL ERROR	PDLL internal system error.
DUT PDLL THREAD CREATION ERROR	PDLL thread creation error.
DUT PDLL INVALID DBG PARAMS	PDLL debug library (dbg_dll.dll) access error.
DUT PDLL DBG_DLL ERROR	PDLL invalid debug library (dbg_dll.dll) parameters.
DUT PDLL HCI STANDARD ERROR	HCI error.
<b>Production test - COM port</b>	
DUT PDLL COM PORT INIT	PDLL Device COM port open initialized.
DUT PDLL COM PORT START	PDLL Device COM port open started.
DUT PDLL COM PORT OK	PDLL Device COM port opened successfully.

**DA1458x/DA1468x Production Line Tool**

Status	Description
DUT_PDLL_COM_PORT_FAILED	PDLL Device COM port failed.
<b>Production test - UART resync</b>	
DUT_PDLL_UART_RESYNC_INIT	UART resync process initialized.
DUT_PDLL_UART_RESYNC_START	UART resync process started.
DUT_PDLL_UART_RESYNC_OK	UART resync process completed successfully.
DUT_PDLL_UART_RESYNC_FAILED	UART resync process failed.
<b>Production test - Firmware version</b>	
DUT_PDLL_FW_VERSION_GET_START	PDLL Firmware version acquisition started.
DUT_PDLL_FW_VERSION_GET_OK	PDLL Device Firmware version acquisition completed successfully.
DUT_PDLL_FW_VERSION_GET_FAILED	PDLL Device Firmware version acquisition failed.
<b>Production test - Current measurement test</b>	
DUT_SLEEP_CURRENT_MEASURE_INIT	Current measurement test initialized.
DUT_SLEEP_CURRENT_MEASURE_START	Current measurement test start.
DUT_SLEEP_DEVICE_SLEPT_OK	Current measurement device mode set successfully.
DUT_SLEEP_CURRENT_MEASURE_ERROR	Current measurement test error.
DUT_SLEEP_CURRENT_MEASURE_PASSED	Current measurement test passed.
DUT_SLEEP_CURRENT_MEASURE_FAILED	Current measurement test failed.
<b>Production test - XTAL trim</b>	
<b>Xtal trim test</b>	
DUT_PDLL_XTAL_TRIM_INIT	XTAL trim operation initialized.
DUT_PDLL_XTAL_TRIM_START	XTAL trim operation started.
DUT_PDLL_XTAL_TRIM_OK	XTAL trim operation ended successfully.
DUT_PDLL_XTAL_TRIM_OUT_OF_RANGE	XTAL trim failed. Input frequency is out of range.
DUT_PDLL_XTAL_TRIM_FREQ_CAL_NOT_CONNECTED	XTAL trim could not be performed. Could not detect external input frequency.
DUT_PDLL_XTAL_TRIM_OTP_WRITE_FAILED	XTAL trim failed. Could not write the calculated value to the OTP header.
DUT_PDLL_XTAL_TRIM_FAILED	XTAL trim failed.
<b>Read value written in OTP</b>	
DUT_PDLL_OTP_XTAL_TRIM_READ_INIT	OTP XTAL trim read operation initialized.
DUT_PDLL_OTP_XTAL_TRIM_READ_START	OTP XTAL trim read operation started.
DUT_PDLL_OTP_XTAL_TRIM_READ_OK	OTP XTAL trim read operation ended successfully.
DUT_PDLL_OTP_XTAL_TRIM_READ_FAILED	OTP XTAL trim read operation failed.
<b>Read register value</b>	
DUT_PDLL_XTAL_TRIM_READ_INIT	XTAL trim value read initialized.
DUT_PDLL_XTAL_TRIM_READ_START	XTAL trim value read started.
DUT_PDLL_XTAL_TRIM_READ_OK	XTAL trim value read success.
DUT_PDLL_XTAL_TRIM_READ_FAILED	XTAL trim value read failed.

**DA1458x/DA1468x Production Line Tool**

Status	Description
<b>Production test - Golden Unit</b>	
<b>Rf test</b>	
DUT_PDLL_GU_RF_RX_TEST_PASSED	Golden Unit RF RX packet test passed.
DUT_PDLL_GU_RF_RX_TEST_FAILED	Golden Unit RF RX packet test failed.
<b>DUT start packet Rx</b>	
DUT_PDLL_PKT_RX_STATS_START_INIT	RF RX packet test with statistics start initialized.
DUT_PDLL_PKT_RX_STATS_START	RF RX packet test with statistics start.
DUT_PDLL_PKT_RX_STATS_STARTED_OK	RF RX packet test with statistics started successfully.
DUT_PDLL_PKT_RX_STATS_START_FAILED	RF RX packet test with statistics started failed.
<b>DUT stop packet Rx</b>	
DUT_PDLL_PKT_RX_STATS_STOP_INIT	RF RX packet test with statistics stop initialized.
DUT_PDLL_PKT_RX_STATS_STOP_START	RF RX packet test with statistics stop.
DUT_PDLL_PKT_RX_STATS_STOPPED_OK	RF RX packet test with statistics stopped successfully.
DUT_PDLL_PKT_RX_STATS_STOP_FAILED	RF RX packet test with statistics stop failed.
<b>Production test - BLE tester</b>	
<b>Tx power measurement</b>	
DUT_BLE_TESTER_TX_PWR_PASSED	BLE tester TX power test passed.
DUT_BLE_TESTER_TX_PWR_FAILED	BLE tester TX power test failed.
<b>Tx carrier offset measure</b>	
DUT_BLE_TESTER_TX_OFFS_PASSED	BLE tester TX frequency offset test passed.
DUT_BLE_TESTER_TX_OFFS_FAILED	BLE tester TX frequency offset test failed.
<b>Tx modulation index measure</b>	
DUT_BLE_TESTER_TX_MOD_IDX_PASSED	BLE tester TX modulation index test passed.
DUT_BLE_TESTER_TX_MOD_IDX_FAILED	BLE tester TX modulation index test failed.
<b>Rx sensitivity test</b>	
DUT_BLE_TESTER_RX_TEST_PASSED	BLE tester RX sensitivity test passed.
DUT_BLE_TESTER_RX_TEST_FAILED	BLE tester RX sensitivity test failed.
<b>DUT packet transaction</b>	
DUT_PDLL_PKT_TX_START_INIT	RF packet TX initialized.
DUT_PDLL_PKT_TX_START	RF packet TX start.
DUT_PDLL_PKT_TX_STARTED_OK	RF packet TX started successfully.
DUT_PDLL_PKT_TX_STARTED_FAILED	RF packet TX failed to start.
DUT_PDLL_PKT_TX_ENDED_START	RF packet TX ended successfully.
DUT_PDLL_PKT_TX_ENDED_OK	RF packet TX end initiated.
DUT_PDLL_PKT_TX_ENDED_FAILED	RF packet TX failed to end.
<b>Production test - GPIO/LED test</b>	
DUT_PDLL_GPIO_TOGGLE_INIT	GPIO-LED test operation initialized.
DUT_PDLL_GPIO_TOGGLE_START	GPIO-LED test operation start.
DUT_PDLL_GPIO_TOGGLE_FINISHED_OK	GPIO-LED test operation completed successfully.

**DA1458x/DA1468x Production Line Tool**

Status	Description
DUT_PDLL_GPIO_TOGGLE_ERROR	GPIO-LED test operation error.
DUT_PDLL_GPIO_TOGGLE_FAILED	GPIO-LED test operation failed.
DUT_PDLL_GPIO_TOGGLE_PASSED	GPIO-LED test operation passed.
<b>Production test - Audio test</b>	
DUT_PDLL_AUDIO_TEST_START_INIT	Audio test start action initialized.
DUT_PDLL_AUDIO_TEST_START	Audio test action start.
DUT_PDLL_AUDIO_TEST_ALREADY_ACTIVE	Audio test is already active.
DUT_PDLL_AUDIO_TEST_STARTED_OK	Audio test action started successfully.
DUT_PDLL_AUDIO_TEST_START_FAILED	Audio test start action failed.
DUT_PDLL_AUDIO_TEST_STOP_INIT	Audio test stop action initialized.
DUT_PDLL_AUDIO_TEST_STOP	Audio test stop action started.
DUT_PDLL_AUDIO_TEST_STOPPED_OK	Audio test stop action completed successfully.
DUT_PDLL_AUDIO_TEST_STOP_FAILED	Audio test stop action failed.
DUT_PDLL_AUDIO_TEST_PASSED	Audio test passed.
DUT_PDLL_AUDIO_TEST_FAILED	Audio test failed.
DUT_PDLL_AUDIO_TEST_INVALID_COMMAND	Audio test invalid command.
<b>Production test - Sensor test</b>	
DUT_PDLL_SENSOR_TEST_INIT	Sensor test action initialized.
DUT_PDLL_SENSOR_TEST_START	Sensor test action start.
DUT_PDLL_SENSOR_TEST_OK	Sensor test action ended successfully.
DUT_PDLL_SENSOR_TEST_FAILED	Sensor test action failed.
DUT_PDLL_SENSOR_TEST_DATA_MATCH_OK	Sensor test action data matched.
DUT_PDLL_SENSOR_TEST_DATA_MATCH_FAILED	Sensor test action data match failure.
<b>Production test - Custom action test</b>	
DUT_PDLL_CUSTOM_ACTION_INIT	Custom test action initialized.
DUT_PDLL_CUSTOM_ACTION_START	Custom test action start.
DUT_PDLL_CUSTOM_ACTION_OK	Custom test action ended successfully.
DUT_PDLL_CUSTOM_ACTION_FAILED	Custom test action failed.
DUT_PDLL_CUSTOM_ACTION_DATA_MATCH_OK	Custom test action data matched.
DUT_PDLL_CUSTOM_ACTION_DATA_MATCH_FAILED	Custom test action data match failure.
<b>Production test - ADC calibration test</b>	
DUT_PDLL_ADC_CALIB_INIT	ADC calibration process. Initializing process.
DUT_PDLL_ADC_CALIB_VBAT_RD_START	ADC calibration process. Start reading VBAT voltage using the external voltage meter instrument.
DUT_PDLL_ADC_CALIB_VBAT_RD_OK	ADC calibration process. VBAT voltage read ended successfully.
DUT_PDLL_ADC_CALIB_VBAT_RD_FAILED	ADC calibration process. VBAT voltage read failed.
DUT_PDLL_ADC_CALIB_DUT_RD_INIT	ADC calibration process. Initialize reading device ADC samples.
DUT_PDLL_ADC_CALIB_DUT_RD_START	ADC calibration process. Start reading device ADC samples.

**DA1458x/DA1468x Production Line Tool**

Status	Description
DUT_PDLL_ADC_CALIB_DUT_RD_OK	ADC calibration process. Device ADC samples read success.
DUT_PDLL_ADC_CALIB_DUT_RD_FAILED	ADC calibration process. Device ADC samples read failed.
DUT_PDLL_ADC_CALIB_OK	ADC calibration process ended successfully.
DUT_PDLL_ADC_CALIB_FAILED	ADC calibration process failed.
<b>Production test - Scan test</b>	
DUT_PDLL_BLE_SCAN_INIT	Scan operation initialized.
DUT_PDLL_BLE_SCAN_START	Scan operation start.
DUT_PDLL_BLE_SCAN_NOT_YET_FOUND	Scan operation. DUT has not been found yet.
DUT_PDLL_BLE_SCAN_FOUND	Scan operation completed successfully. DUT was found.
DUT_PDLL_BLE_SCAN_FAILED	Scan operation failed. DUT was not found.
<b>Memory programming - Generic errors</b>	
DUT_UDLL_SUCCESS	UDLL returned success.
DUT_UDLL_ACTION_RESPONSE_ERROR	UDLL device responded with error.
DUT_UDLL_UART_RX_TIMEOUT_ERROR	UDLL UART RX timeout. Cannot communicate with the DUT or DUT is not present.
DUT_UDLL_NO_CRC_MATCH_ERROR	UDLL CRC match error.
DUT_UDLL_PROG_PARAMS_ERROR	UDLL programming parameter error.
DUT_UDLL_DEVICE_PARAMS_ERROR	UDLL device parameter error.
DUT_UDLL_UART_WRITE_ERROR	UDLL UART write returned error.
DUT_UDLL_UART_READ_ERROR	UDLL UART read returned error.
DUT_UDLL_INTERNAL_ERROR	UDLL internal error.
DUT_UDLL_COM_PORT_INIT_ERROR	UDLL COM port initialization error.
DUT_UDLL_COM_PORT_ERROR	UDLL COM port error.
DUT_UDLL_CANNOT_ALLOCATE_MEMORY	UDLL cannot allocate memory.
DUT_UDLL_READ_FILE_SIZE_ERROR	UDLL read file size error.
DUT_UDLL_CANNOT_OPEN_FW_FILE	UDLL cannot open firmware file.
DUT_UDLL_CANNOT_OPEN_IMAGE_FILE	UDLL cannot open image file.
DUT_UDLL_UART_PINS_PATCH_ERROR	UDLL cannot patch the UART pins into the firmware file.
DUT_UDLL_INVALID_DBG_PARAMS	UDLL invalid debug library (dbg_dll.dll) parameters.
DUT_UDLL_DBG_DLL_ERROR	UDLL debug library (dbg_dll.dll) access error.
<b>Firmware download</b>	
DUT_UDLL_FW_DOWNLOAD_INIT	UDLL firmware download initialized.
DUT_UDLL_FW_DOWNLOAD_STARTED	UDLL firmware download started successfully.
DUT_UDLL_FW_DOWNLOAD_RETRY	UDLL firmware download retry.
DUT_UDLL_FW_DOWNLOAD_OK	UDLL firmware downloaded successfully.
DUT_UDLL_FW_DOWNLOAD_FAILED	UDLL firmware download failed.

**DA1458x/DA1468x Production Line Tool**

Status	Description
<b>Memory programming - OTP image write</b>	
DUT_UDLL_OTP_IMG_WR_INIT	OTP image write operation initialized.
DUT_UDLL_OTP_IMG_WR_STARTED	OTP image write operation started.
DUT_UDLL_OTP_IMG_WR_OK	OTP image write operation ended successfully.
DUT_UDLL_OTP_IMG_WR_FAILED	OTP image write operation failed.
<b>Memory programming - BD address write to OTP memory</b>	
DUT_UDLL_OTP_BDA_WR_INIT	OTP BD address write operation initialized.
DUT_UDLL_OTP_BDA_WR_STARTED	OTP BD address write operation started.
DUT_UDLL_OTP_BDA_WR_OK	OTP BD address write operation ended successfully.
DUT_UDLL_OTP_BDA_WR_FAILED	OTP BD address write operation failed.
<b>Memory programming - BD address read/compare to OTP memory</b>	
DUT_UDLL_OTP_BDA_RD_INIT	OTP BD address read operation initialized.
DUT_UDLL_OTP_BDA_RD_STARTED	OTP BD address read operation started.
DUT_UDLL_OTP_BDA_RD_OK	OTP BD address read operation ended successfully.
DUT_UDLL_OTP_BDA_RD_FAILED	OTP BD address read operation failed.
DUT_UDLL_OTP_BDA_CMP_OK	OTP BD address comparison success.
DUT_UDLL_OTP_BDA_CMP_FAILED	OTP BD address comparison failed. No match.
<b>Memory programming - XTAL trim value write to OTP memory</b>	
DUT_UDLL_OTP_XTAL_TRIM_WR_INIT	OTP XTAL trim value write operation initialized.
DUT_UDLL_OTP_XTAL_TRIM_WR_STARTED	OTP XTAL trim value write operation started.
DUT_UDLL_OTP_XTAL_TRIM_WR_OK	OTP XTAL trim value write operation ended successfully.
DUT_UDLL_OTP_XTAL_TRIM_WR_FAILED	OTP XTAL trim value write operation failed.
<b>Memory programming - ADC calibration value write to OTP memory</b>	
DUT_UDLL_OTP_ADC_CALIB_WR_INIT	OTP ADC calibration value write operation initialized.
DUT_UDLL_OTP_ADC_CALIB_WR_STARTED	OTP ADC calibration value write operation started.
DUT_UDLL_OTP_ADC_CALIB_WR_OK	OTP ADC calibration value write operation ended successfully.
DUT_UDLL_OTP_ADC_CALIB_WR_FAILED	OTP ADC calibration value write operation failed.
<b>Memory programming - OTP header write</b>	
DUT_UDLL_OTP_HDR_WR_INIT	OTP header write operation initialized.
DUT_UDLL_OTP_HDR_WR_STARTED	OTP header write operation started.
DUT_UDLL_OTP_HDR_WR_OK	OTP header write operation ended successfully.
DUT_UDLL_OTP_HDR_WR_FAILED	OTP header write operation failed.
<b>Memory programming - OTP memory check-empty operation</b>	
DUT_UDLL_OTP_CHECK_EMPTY_INIT	Operation to check whether the OTP field to burn is empty initialized.
DUT_UDLL_OTP_CHECK_EMPTY_STARTED	Operation to check whether the OTP field to burn is empty started.
DUT_UDLL_OTP_CHECK_EMPTY_OK	The OTP field to burn is empty.
DUT_UDLL_OTP_CHECK_SAME_DATA_OK	The OTP field contains the same data as the ones to

**DA1458x/DA1468x Production Line Tool**

Status	Description
	burn.
DUT_UDLL_OTP_CHECK_EMPTY_FAILED	The OTP field is already burned with data.
<b>Memory programming - SPI memory erase</b>	
DUT_UDLL_SPI_ERASE_INIT	SPI erase operation initialized.
DUT_UDLL_SPI_ERASE_STARTED	SPI erase operation started.
DUT_UDLL_SPI_ERASE_OK	SPI erase operation ended successfully.
DUT_UDLL_SPI_ERASE_FAILED	SPI erase operation failed.
<b>Memory programming - SPI memory check empty</b>	
DUT_UDLL_SPI_CHECK_EMPTY_INIT	SPI check if empty operation initialized.
DUT_UDLL_SPI_CHECK_EMPTY_STARTED	SPI check if empty operation started,
DUT_UDLL_SPI_CHECK_EMPTY_OK	SPI check if empty operation ended successfully,
DUT_UDLL_SPI_CHECK_EMPTY_FAILED	SPI check if empty operation failed,
<b>Memory programming - SPI image write</b>	
DUT_UDLL_SPI_IMG_WR_INIT	SPI image write operation initialized.
DUT_UDLL_SPI_IMG_WR_STARTED	SPI image write operation started.
DUT_UDLL_SPI_IMG_WR_OK	SPI image write operation ended successfully.
DUT_UDLL_SPI_IMG_WR_FAILED	SPI image write operation failed.
<b>Memory programming - EEPROM image write</b>	
DUT_UDLL_EEPROM_IMG_WR_INIT	EEPROM image write operation initialized.
DUT_UDLL_EEPROM_IMG_WR_STARTED	EEPROM image write operation started.
DUT_UDLL_EEPROM_IMG_WR_OK	EEPROM image write operation ended successfully.
DUT_UDLL_EEPROM_IMG_WR_FAILED	EEPROM image write operation failed.
<b>Memory programming - QSPI memory erase</b>	
DUT_UDLL_QSPI_ERASE_INIT	QSPI erase operation initialized.
DUT_UDLL_QSPI_ERASE_STARTED	QSPI erase operation started.
DUT_UDLL_QSPI_ERASE_OK	QSPI erase operation ended successfully.
DUT_UDLL_QSPI_ERASE_FAILED	QSPI erase operation failed.
<b>Memory programming - QSPI memory check empty</b>	
DUT_UDLL_QSPI_CHECK_EMPTY_INIT	QSPI check if empty operation initialized.
DUT_UDLL_QSPI_CHECK_EMPTY_STARTED	QSPI check if empty operation started.
DUT_UDLL_QSPI_CHECK_EMPTY_OK	QSPI check if empty operation ended successfully.
DUT_UDLL_QSPI_CHECK_EMPTY_FAILED	QSPI check if empty operation failed.
<b>Memory programming - QSPI image write</b>	
DUT_UDLL_QSPI_IMG_WR_INIT	QSPI image write operation initialized.
DUT_UDLL_QSPI_IMG_WR_STARTED	QSPI image write operation started.
DUT_UDLL_QSPI_IMG_WR_OK	QSPI image write operation ended successfully.
DUT_UDLL_QSPI_IMG_WR_FAILED	QSPI image write operation failed.
<b>Memory programming - BD address write to QSPI memory</b>	
DUT_UDLL_QSPI_BDA_WR_INIT	QSPI BD address write operation initialized.



**DA1458x/DA1468x Production Line Tool**

Status	Description
DUT_UDLL_QSPI_BDA_WR_STARTED	QSPI BD address write operation started.
DUT_UDLL_QSPI_BDA_WR_OK	QSPI BD address write operation ended successfully.
DUT_UDLL_QSPI_BDA_WR_FAILED	QSPI BD address write operation failed.
<b>Memory programming - BD address read/compare to QSPI memory</b>	
DUT_UDLL_QSPI_BDA_RD_INIT	QSPI BD address read operation initialized.
DUT_UDLL_QSPI_BDA_RD_STARTED	QSPI BD address read operation started.
DUT_UDLL_QSPI_BDA_RD_OK	QSPI BD address read operation ended successfully.
DUT_UDLL_QSPI_BDA_RD_FAILED	QSPI BD address read operation failed.
DUT_UDLL_QSPI_BDA_CMP_OK	QSPI BD address comparison success.
DUT_UDLL_QSPI_BDA_CMP_FAILED	QSPI BD address comparison failed. No match.
<b>Memory programming - XTAL trim value write to QSPI memory</b>	
DUT_UDLL_QSPI_XTAL_TRIM_WR_INIT	QSPI XTAL trim value write operation initialized.
DUT_UDLL_QSPI_XTAL_TRIM_WR_STARTED	QSPI XTAL trim value write operation started.
DUT_UDLL_QSPI_XTAL_TRIM_WR_OK	QSPI XTAL trim value write operation ended successfully.
DUT_UDLL_QSPI_XTAL_TRIM_WR_FAILED	QSPI XTAL trim value write operation failed.
<b>Memory programming - ADC calibration value write to QSPI memory</b>	
DUT_UDLL_QSPI_ADC_CALIB_WR_INIT	QSPI ADC calibration value write operation initialized.
DUT_UDLL_QSPI_ADC_CALIB_WR_STARTED	QSPI ADC calibration value write operation started.
DUT_UDLL_QSPI_ADC_CALIB_WR_OK	QSPI ADC calibration value write operation ended successfully.
DUT_UDLL_QSPI_ADC_CALIB_WR_FAILED	QSPI ADC calibration value write operation failed.
<b>Memory programming - Custom data memory write</b>	
DUT_UDLL_MEM_DATA_WR_INIT	Custom memory data burn operation initialized.
DUT_UDLL_MEM_DATA_WR_STARTED	Custom memory data burn operation started.
DUT_UDLL_MEM_DATA_WR_OK	Custom memory data burn operation ended successfully.
DUT_UDLL_MEM_DATA_WR_FAILED	Custom memory data burn operation failed.
<b>Memory programming - memory read operation</b>	
DUT_UDLL_MEM_RD_INIT	Memory read operation initialized.
DUT_UDLL_MEM_RD_STARTED	Memory read operation started.
DUT_UDLL_MEM_RD_OK	Memory read operation ended successfully.
DUT_UDLL_MEM_RD_FAILED	Memory read operation failed.

## Appendix S Golden Unit Status Codes

Table 102 contains all the possible status codes the Golden Unit can have, followed by a brief description. The table categorizes the status based on the various states the Golden Unit may be during testing and programming the DUTs.

**Table 102: Golden Unit Status Codes**

Status	Description
<b>Generic</b>	
GU_NOT_ACTIVE	Golden Unit is not active.
GU_INTERNAL_SYSTEM_ERROR	Internal system error.
GU_COM_OPEN_OK	COM port opened successfully.
GU_COM_OPEN_FAILED	COM port failed to open
GU_PDLL_NO_ERROR	PDLL returned success.
GU_PDLL_PARAMS_ERROR	Golden Unit PDLL parameters have errors.
GU_PDLL_RX_TIMEOUT	Golden Unit did not reply on a PDLL message request. GU COM port may not be correct or it may need manual RESET.
GU_PDLL_TX_TIMEOUT	Golden Unit Tx timeout when sending a message to the device.
GU_PDLL_UNEXPECTED_EVENT	Received an unexpected message from the Golden Unit.
GU_PDLL_CANNOT_ALLOCATE_MEMORY	PDLL cannot allocate memory.
GU_PDLL_INTERNAL_ERROR	PDLL internal system error.
GU_PDLL_THREAD_CREATION_ERROR	PDLL thread creation error.
GU_PDLL_DBG_DLL_ERROR	PDLL debug library (dbg_dll.dll) access error.
GU_PDLL_INVALID_DBG_PARAMS	PDLL invalid debug library (dbg_dll.dll) parameters.
GU_PDLL_HCI_STANDARD_ERROR	Golden Unit HCI error.
<b>Golden Unit reset operation</b>	
GU_RESET_START	Golden Unit HW reset started.
GU_RESET_OK	Golden Unit HW reset OK.
GU_RESET_FAILED	Golden Unit HW reset FAILED.
<b>Golden Unit COM port handling</b>	
GU_PDLL_COM_PORT_INIT	Golden Unit COM port open initialized.
GU_PDLL_COM_PORT_START	Golden Unit COM port open started.
GU_PDLL_COM_PORT_OK	Golden Unit COM port opened OK.
GU_PDLL_COM_PORT_FAILED	Golden Unit COM port FAILED.
<b>Golden Unit firmware version</b>	
GU_PDLL_FW_VERSION_GET_START	Golden Unit PDLL firmware version acquisition started.
GU_PDLL_FW_VERSION_GET_OK	Golden Unit PDLL firmware version acquisition OK.
GU_PDLL_FW_VERSION_GET_FAILED	Golden Unit PDLL firmware version acquisition FAILED.
GU_PDLL_FW_VERSION_VALID	The Golden Unit firmware version is valid.
GU_PDLL_FW_VERSION_NOT_VALID	The Golden Unit firmware version is not valid. An upgrade may be needed.

**DA1458x/DA1468x Production Line Tool**

Status	Description
<b>Golden Unit CPLD control</b>	
GU_PDLL_RDTESTER_INIT	PLT HW tester initializing.
GU_PDLL_RDTESTER_INIT_START	PLT HW tester initialize started.
GU_PDLL_RDTESTER_INIT_OK	PLT HW tester initialized successful.
GU_PDLL_RDTESTER_INIT_FAILED	PLT HW tester initialization failed.
GU_PDLL_RDTESTER_UART_CONNECT_INIT	PLT HW tester UART connection initialized.
GU_PDLL_RDTESTER_UART_CONNECT_START	PLT HW tester UART connection started.
GU_PDLL_RDTESTER_UART_CONNECT_OK	PLT HW tester UART connected successfully.
GU_PDLL_RDTESTER_UART_CONNECT_FAILED	PLT HW tester UART connection failed.
GU_PDLL_RDTESTER_UART_LOOPBACK_INIT	PLT HW tester UART loopback process initialized.
GU_PDLL_RDTESTER_UART_LOOPBACK_START	PLT HW tester UART loopback process started.
GU_PDLL_RDTESTER_UART_LOOPBACK_OK	PLT HW tester UART loopback process success.
GU_PDLL_RDTESTER_UART_LOOPBACK_FAILED	PLT HW tester UART loopback process failed.
GU_PDLL_RDTESTER_VBAT_UART_CNTRL_INIT	PLT HW tester VBAT/UART control initialized.
GU_PDLL_RDTESTER_VBAT_UART_CNTRL_START	PLT HW tester VBAT/UART control started.
GU_PDLL_RDTESTER_VBAT_UART_CNTRL_OK	PLT HW tester VBAT/UART control success.
GU_PDLL_RDTESTER_VBAT_UART_CNTRL_FAILED	PLT HW tester VBAT/UART control failed.
GU_PDLL_RDTESTER_VPP_CNTRL_INIT	PLT HW tester VPP control initialized.
GU_PDLL_RDTESTER_VPP_CNTRL_START	PLT HW tester VPP control started.
GU_PDLL_RDTESTER_VPP_CNTRL_OK	PLT HW tester VPP control success.
GU_PDLL_RDTESTER_VPP_CNTRL_FAILED	PLT HW tester VPP control failed.
GU_PDLL_RDTESTER_RST_PULSE_INIT	PLT HW tester Reset pulse control initialized.
GU_PDLL_RDTESTER_RST_PULSE_START	PLT HW tester Reset pulse control started.
GU_PDLL_RDTESTER_RST_PULSE_OK	PLT HW tester Reset pulse control success.
GU_PDLL_RDTESTER_RST_PULSE_FAILED	PLT HW tester Reset pulse control failed.
GU_PDLL_RDTESTER_UART_PULSE_INIT	PLT HW tester XTAL trim pulse in UART TX pin initialized.
GU_PDLL_RDTESTER_UART_PULSE_START	PLT HW tester XTAL trim pulse in UART TX pin started.
GU_PDLL_RDTESTER_UART_PULSE_OK	PLT HW tester XTAL trim pulse in UART TX pin success.
GU_PDLL_RDTESTER_UART_PULSE_FAILED	PLT HW tester XTAL trim pulse in UART TX pin failed.
GU_PDLL_RDTESTER_XTAL_PULSE_INIT	PLT HW tester XTAL trim pulse in GATE pin initialized.
GU_PDLL_RDTESTER_XTAL_PULSE_START	PLT HW tester XTAL trim pulse in GATE pin started.
GU_PDLL_RDTESTER_XTAL_PULSE_OK	PLT HW tester XTAL trim pulse in GATE pin success.
GU_PDLL_RDTESTER_XTAL_PULSE_FAILED	PLT HW tester XTAL trim pulse in GATE pin failed.
GU_PDLL_RDTESTER_PULSE_WIDTH_INIT	PLT HW tester pulse width initialized.
GU_PDLL_RDTESTER_PULSE_WIDTH_START	PLT HW tester pulse width started.
GU_PDLL_RDTESTER_PULSE_WIDTH_OK	PLT HW tester pulse width success.
GU_PDLL_RDTESTER_PULSE_WIDTH_FAILED	PLT HW tester pulse width failed.
GU_PDLL_RDTESTER_VBAT_CNTRL_INIT	PLT HW tester VBAT control initialized.
GU_PDLL_RDTESTER_VBAT_CNTRL_START	PLT HW tester VBAT control started.

**DA1458x/DA1468x Production Line Tool**

Status	Description
GU_PDLL_RDTESTER_VBAT_CNTRL_OK	PLT HW tester VBAT control success.
GU_PDLL_RDTESTER_VBAT_CNTRL_FAILED	PLT HW tester VBAT control failed.
GU_PDLL_RDTESTER_INVALID_COMMAND	PLT HW tester unknown command.
<b>Golden Unit RF packet transmission for DUT RSSI RF test</b>	
GU_PDLL_PKT_TX_START_INIT	Golden Unit RF packet TX initialized.
GU_PDLL_PKT_TX_START	Golden Unit RF packet TX started.
GU_PDLL_PKT_TX_STARTED_OK	Golden Unit RF packet TX success.
GU_PDLL_PKT_TX_STARTED_FAILED	Golden Unit RF packet TX failed.
GU_PDLL_PKT_TX_ENDED_OK	Golden Unit RF packet TX ended successfully.
GU_PDLL_PKT_TX_STARTED_FAILED	Golden Unit RF packet TX ended failed.
<b>Golden Unit audio tone generation for audio testing</b>	
GU_PDLL_AUDIO_TONE_START_INIT	Golden Unit audio tone start initialized.
GU_PDLL_AUDIO_TONE_START	Golden Unit audio tone start.
GU_PDLL_AUDIO_TONE_STARTED_OK	Golden Unit audio tone started successfully.
GU_PDLL_AUDIO_TONE_START_FAILED	Golden Unit audio tone start failed.
GU_PDLL_AUDIO_TONE_STOP_INIT	Golden Unit audio tone stop initialized.
GU_PDLL_AUDIO_TONE_STOP	Golden Unit audio tone stop.
GU_PDLL_AUDIO_TONE_STOPPED_OK	Golden Unit audio tone stopped successfully.
GU_PDLL_AUDIO_TONE_STOP_FAILED	Golden Unit audio tone stop failed.
<b>Golden Unit GPIO toggling for sanity test</b>	
GU_PDLL_GPIO_TOGGLE_INIT	Golden Unit GPIO toggle operation initialized.
GU_PDLL_GPIO_TOGGLE_START	Golden Unit GPIO toggle operation start.
GU_PDLL_GPIO_TOGGLE_FINISHED_OK	Golden Unit GPIO toggle operation completed successfully.
GU_PDLL_GPIO_TOGGLE_FAILED	Golden Unit GPIO toggle operation failed.
<b>Golden Unit BLE advertising scan test</b>	
GU_PDLL_BLE_SCAN_INIT	Golden Unit scan operation initialized.
GU_PDLL_BLE_SCAN_START	Golden Unit scan operation started.
GU_PDLL_BLE_SCAN_OK	Golden Unit scan operation completed successfully.
GU_PDLL_BLE_SCAN_FAILED	Golden Unit scan operation failed.

**Revision History**

<b>Revision</b>	<b>Date</b>	<b>Description</b>
1.0	08-Jul-2015	Initial version.
1.1	18-Jan-2016	CLI part is added and Rev D. PLT Hardware
2.0	04-May-2016	Adding text and drawings
3.0	22-May-2016	Adding changes for the DA1468x
4.0	22-Dec-2016	Updated for DA1458x_DA1468x_PLT_v4.0 software release
4.1	06-Oct-2017	Updated for DA1458x_DA1468x_PLT_v4.1 software release
4.2	10-Oct-2017	Updated for DA1458x_DA1468x_PLT_v4.2 software release
4.3	03-Feb-2022	Updated logo, disclaimer, copyright.

---

**DA1458x/DA1468x Production Line Tool****Status Definitions**

<b>Status</b>	<b>Definition</b>
DRAFT	The content of this document is under review and subject to formal approval, which may result in modifications or additions.
APPROVED or unmarked	The content of this document has been approved for publication.

**RoHS Compliance**

Dialog Semiconductor's suppliers certify that its products are in compliance with the requirements of Directive 2011/65/EU of the European Parliament on the restriction of the use of certain hazardous substances in electrical and electronic equipment. RoHS certificates from our suppliers are available on request.