

# Emulation Adapter for the RH850/E2UH and E2H Groups

RTE7702012EAB00000J

User's Manual

All information contained in these materials, including products and product specifications, represents information on the product at the time of publication and is subject to change by Renesas Electronics Corp. without notice. Please review the latest information published by Renesas Electronics Corp. through various means, including the Renesas Electronics Corp. website (<http://www.renesas.com>).

## Notice

1. Descriptions of circuits, software and other related information in this document are provided only to illustrate the operation of semiconductor products and application examples. You are fully responsible for the incorporation or any other use of the circuits, software, and information in the design of your product or system. Renesas Electronics disclaims any and all liability for any losses and damages incurred by you or third parties arising from the use of these circuits, software, or information.
2. Renesas Electronics hereby expressly disclaims any warranties against and liability for infringement or any other claims involving patents, copyrights, or other intellectual property rights of third parties, by or arising from the use of Renesas Electronics products or technical information described in this document, including but not limited to, the product data, drawings, charts, programs, algorithms, and application examples.
3. No license, express, implied or otherwise, is granted hereby under any patents, copyrights or other intellectual property rights of Renesas Electronics or others.
4. You shall not alter, modify, copy, or reverse engineer any Renesas Electronics product, whether in whole or in part. Renesas Electronics disclaims any and all liability for any losses or damages incurred by you or third parties arising from such alteration, modification, copying or reverse engineering.
5. Renesas Electronics products are classified according to the following two quality grades: "Standard" and "High Quality". The intended applications for each Renesas Electronics product depends on the product's quality grade, as indicated below.  
"Standard": Computers; office equipment; communications equipment; test and measurement equipment; audio and visual equipment; home electronic appliances; machine tools; personal electronic equipment; industrial robots; etc.  
"High Quality": Transportation equipment (automobiles, trains, ships, etc.); traffic control (traffic lights); large-scale communication equipment; key financial terminal systems; safety control equipment; etc.  
Unless expressly designated as a high reliability product or a product for harsh environments in a Renesas Electronics data sheet or other Renesas Electronics document, Renesas Electronics products are not intended or authorized for use in products or systems that may pose a direct threat to human life or bodily injury (artificial life support devices or systems; surgical implantations; etc.), or may cause serious property damage (space system; undersea repeaters; nuclear power control systems; aircraft control systems; key plant systems; military equipment; etc.). Renesas Electronics disclaims any and all liability for any damages or losses incurred by you or any third parties arising from the use of any Renesas Electronics product that is inconsistent with any Renesas Electronics data sheet, user's manual or other Renesas Electronics document.
6. When using Renesas Electronics products, refer to the latest product information (data sheets, user's manuals, application notes, "General Notes for Handling and Using Semiconductor Devices" in the reliability handbook, etc.), and ensure that usage conditions are within the ranges specified by Renesas Electronics with respect to maximum ratings, operating power supply voltage range, heat dissipation characteristics, installation, etc. Renesas Electronics disclaims any and all liability for any malfunctions, failure or accident arising out of the use of Renesas Electronics products outside of such specified ranges.
7. Although Renesas Electronics endeavors to improve the quality and reliability of Renesas Electronics products, semiconductor products have specific characteristics, such as the occurrence of failure at a certain rate and malfunctions under certain use conditions. Unless designated as a high reliability product or a product for harsh environments in a Renesas Electronics data sheet or other Renesas Electronics document, Renesas Electronics products are not subject to radiation resistance design. You are responsible for implementing safety measures to guard against the possibility of bodily injury, injury or damage caused by fire, and/or danger to the public in the event of a failure or malfunction of Renesas Electronics products, such as safety design for hardware and software, including but not limited to redundancy, fire control and malfunction prevention, appropriate treatment for aging degradation or any other appropriate measures. Because the evaluation of microcomputer software alone is very difficult and impractical, you are responsible for evaluating the safety of the final products or systems manufactured by you.
8. Please contact a Renesas Electronics sales office for details as to environmental matters such as the environmental compatibility of each Renesas Electronics product. You are responsible for carefully and sufficiently investigating applicable laws and regulations that regulate the inclusion or use of controlled substances, including without limitation, the EU RoHS Directive, and using Renesas Electronics products in compliance with all these applicable laws and regulations. Renesas Electronics disclaims any and all liability for damages or losses occurring as a result of your noncompliance with applicable laws and regulations.
9. Renesas Electronics products and technologies shall not be used for or incorporated into any products or systems whose manufacture, use, or sale is prohibited under any applicable domestic or foreign laws or regulations. You shall comply with any applicable export control laws and regulations promulgated and administered by the governments of any countries asserting jurisdiction over the parties or transactions.
10. It is the responsibility of the buyer or distributor of Renesas Electronics products, or any other party who distributes, disposes of, or otherwise sells or transfers the product to a third party, to notify such third party in advance of the contents and conditions set forth in this document.
11. This document shall not be reprinted, reproduced or duplicated in any form, in whole or in part, without prior written consent of Renesas Electronics.
12. Please contact a Renesas Electronics sales office if you have any questions regarding the information contained in this document or Renesas Electronics products.

(Note 1) "Renesas Electronics" as used in this document means Renesas Electronics Corporation and also includes its directly or indirectly controlled subsidiaries.

(Note 2) "Renesas Electronics product(s)" means any product developed or manufactured by or for Renesas Electronics.

## Preface

The emulation adapter is an emulation board which is designed for use with RH850 family MCUs from Renesas Electronics Corporation.

All components that come with the emulation adapter are listed under “1.1 Package Components”. If you have any questions about the emulation adapter, contact your local distributor.

This user’s manual is mainly to describe the specifications of the emulation adapter. For the specifications of the exchange adapters, refer to appendix A, Specifications of the Exchange Adapter, in this document.

For information on emulator debuggers and related products, please see the user’s manuals, additional documents for user’s manuals, and application notes provided for the individual products. When you use an emulator from another company for debugging, be sure to read the user’s manual for the given emulator.

### Related Documents

Name of Document	Document No.
IE850A Emulator RTE0T0850AKCT00000J User’s Manual	R20UT4461E
E2 Emulator RTE0T00020KCE00000R User’s Manual	R20UT3538E
E2 Emulator, IE850A Emulator Additional Document for User’s Manual (Notes on Connection of RH850/E2x Series)	R20UT4140E

Note: The contents of the related documents listed above may be changed without prior notice. Be sure to use the latest versions of the documents, which can be downloaded from “Software and Tools” on the Renesas Web page.

<https://www.renesas.com/>

# Important

Before using this product, be sure to read this user's manual carefully.

Keep this user's manual, and refer to it when you have questions about this product.

Purpose of use of this product:

This product is for the support of the development of systems that use RH850-family MCUs from Renesas. It provides support for system development in both software and hardware.

Be sure to use this product correctly according to said purpose of use. Please avoid using this product other than for its intended purpose of use.

For those who use this product:

This product can only be used by those who have carefully read the user's manual and know how to use it.

Use of this product requires basic knowledge of electric circuits, logical circuits, and MCUs.

When using the product:

- (1) This product is a development-support unit for use in your program development and evaluation stages. When a program you have finished developing is to be incorporated in a mass-produced product, the judgment as to whether it can be put to practical use is entirely your own responsibility, and should be based on evaluation of the device on which it is installed and other experiments.
- (2) In no event shall Renesas Electronics Corp. be liable for any consequence arising from the use of this product.
- (3) Renesas Electronics Corp. strives to provide workarounds for and correct trouble with products malfunctions, with some free and some incurring charges. However, this does not necessarily mean that Renesas Electronics Corp. guarantees the provision of a workaround or correction under any circumstances.
- (4) The product covered by this document has been developed on the assumption that it will be used for program development and evaluation in laboratories. Therefore, it does not fall within the scope of applicability of the Electrical Appliance and Material Safety Law and protection against electromagnetic interference when used in Japan.
- (5) Renesas Electronics Corp. cannot predict all possible situations and possible cases of misuse that carry a potential for danger. Therefore, the warnings in this user's manual and the warning labels attached to the product do not necessarily cover all such possible situations and cases. The customer is responsible for correctly and safely using this product.
- (6) The product covered by this document has been through the process of checking conformance with the standards indicated in section 1.3, Regulatory Compliance Notices. This fact must be taken into account when the product is taken from Japan to another country.
- (7) Renesas Electronics Corp. will not assume responsibility for direct or indirect damage caused by an accidental failure or malfunction of this product.

When disposing of the product:

Penalties may be applicable for incorrect disposal of this waste, in accordance with your national legislation.

#### Usage restrictions:

The product has been developed as a means of supporting system development by users. Therefore, do not use it as an embedded device in other equipment. Also, do not use it to develop systems or equipment for use in the following fields.

- (1) Transportation and vehicular
- (2) Medical (equipment that has an involvement in human life)
- (3) Aerospace
- (4) Nuclear power control
- (5) Undersea repeaters

If you are considering the use of the product for one of the above purposes, please be sure to consult your local distributor.

#### About product changes:

We are constantly making efforts to improve the design and performance of this product. Therefore, the specification or design of this product, or this user's manual, may be changed without prior notice.

#### About rights:

- (1) We assume no responsibility for any damage or infringement on patent rights or any other rights arising from the use of any information, products or circuits presented in this user's manual.
- (2) The information or data in this user's manual does not implicitly or otherwise grant a license to patent rights or any other rights belonging to Renesas or to a third party.
- (3) This user's manual and this product are copyrighted, with all rights reserved by Renesas. This user's manual may not be copied, duplicated or reproduced, in whole or part, without prior written consent from Renesas.

#### About diagrams:

Some diagrams in this user's manual may differ from the objects they represent.

## Precautions for Safety

This chapter describes the precautions which should be taken in order to use this product safely and properly. Be sure to read and understand this chapter before using this product. Contact your local distributor if you have any questions about the precautions described here.



### WARNING

**WARNING** indicates a potentially dangerous situation that will cause death or heavy wound unless it is avoided.



### CAUTION

**CAUTION** indicates a potentially dangerous situation that will cause a slight injury or a medium-degree injury unless it is avoided.

To avoid a possible danger, the following diagrammatic symbols are used to call your attention.

△ means WARNING or CAUTION.

Example:



CAUTION AGAINST AN ELECTRIC SHOCK

⊘ means PROHIBITION.

Example:



DISASSEMBLY PROHIBITED

● means A FORCIBLE ACTION.

Example:



UNPLUG THE POWER CABLE FROM THE RECEPTACLE.

## **WARNING**

### Warnings for AC Power Supply:



Do not repair or remodel the emulator product by yourself in order to prevent danger such as an electric shock or fire and for the sake of quality assurance. For after-sale services in case of a mechanical or electrical fault, please contact your local distributor.

Always switch off the user system before connecting or disconnecting any connectors or cables. Neglecting to take this precaution may result in an electric shock or in this product emitting smoke or catching fire. Also, a user program being debugged may be destroyed.

Make sure that the connectors and cables are connected in the correct directions.

Neglect of this precaution will result in getting an electric shock or will result in this product emitting smoke or catching fire.

### Warning for Modification:



Do not modify this product. Personal injury due to electric shock may occur if the product is modified. Modifying the product will void your warranty.

### Warning for Installation:



Do not set this product in water or areas of high humidity. Make sure that the product does not get wet. Spilling water or some other liquid into the product may cause un-repairable damage.

### Warning for Use Temperature:



This product is to be used in an environment with a maximum ambient temperature of 40°C.

Care should be taken that this temperature is not exceeded.

## CAUTION

### Cautions to Be Taken for Handling This Product:



Use caution when handling this product. Be careful not to apply a mechanical shock.

Do not operate switches before removing static electricity from the operator's body. Doing so may lead to the discharge of static electricity and so damage the internal circuits. Also, do not directly touch connector pins.

When attaching and removing the cable, hold a fixture (such as a connector) to avoid pulling the cable.

### Caution to Be Taken for System Malfunctions:



If this product malfunctions because of interference like external noise, do the following to remedy the trouble.

(1) Exit the emulator debugger, and turn off the emulator and the target system.

(2) After a lapse of 10 seconds, turn on the power of this product again, then launch the emulator debugger.

### Caution to Be Taken for Disposal:



Penalties may be applicable for incorrect disposal of this waste, in accordance with your national legislation.

### European Union Regulatory Notices:



The WEEE (Waste Electrical and Electronic Equipment) regulations put responsibilities on producers for the collection and recycling or disposal of electrical and electronic waste. Return of WEEE under these regulations is applicable in the European Union only. This equipment (including all accessories) is not intended for household use. After use the equipment cannot be disposed of as household waste, and the WEEE must be treated, recycled and disposed of in an environmentally sound manner.

Renesas Electronics Europe GmbH can take back end of life equipment, register for this service at "<http://www.renesas.eu/weee>".



# Contents

Preface.....	3
Important.....	4
Precautions for Safety .....	6
Contents .....	9
Terminology.....	10
1. Outline.....	11
1.1 Package Components .....	11
1.2 Product Specifications.....	12
1.3 Regulatory Compliance Notices .....	13
2. Names and Functions of Hardware.....	15
2.1 Emulation Adapter (RTE7702012EAB00000J).....	15
2.2 Base Board (RTE7702012EABBB000J).....	20
2.3 34-Pin to 14-Pin Conversion Adapter (RTE0T00020KCA30000J).....	25
2.4 Power-Supply Cable .....	26
2.5 Demounting Lever .....	27
3. System Configuration and Setup .....	28
3.1 System Configuration as a Simple Evaluation Board .....	28
3.2 System Configuration as an Emulation Board .....	33
4. Notes .....	39
4.1 Setting Option Bytes .....	39
4.2 Notes on Differences between the Actual Device and the Emulation Adapter.....	39
5. Characteristics of Target Interface.....	41
6. Maintenance and Warranty .....	42
6.1 Maintenance.....	42
6.2 Warranty .....	42
6.3 Repair Provisions.....	42
6.4 How to Request Repairs.....	43
Appendix A Specifications of the Exchange Adapter .....	44
Revision History .....	50

# Terminology

Some specific words used in this user's manual are defined below.

## Target device

This means the device to be emulated or debugged.

## Debug chip

This means the device that emulates the operation of the target device and implements debugging facilities such as tracing.

## Aurora tracing

Aurora is a high-speed communications protocol from Xilinx Inc. The debug chip is capable of using Aurora as a trace interface.

## Target system

This means the user-created system which is to be debugged. This includes both hardware and software created by the user.

## Emulation adapter

This is a board which emulates the device to be debugged. A debug chip is mounted on the board.

## Base board

This board is for operating the emulation adapter as a stand-alone unit.

## Exchange adapter

This is a board that exchanges the connections of the emulation adapter to suit the package of the target device.

## 1. Outline

This product is an emulation adapter for the RH850/E2UH and E2H groups of MCUs from Renesas Electronics Corporation. Using this product with the separately sold exchange adapter enables emulation of the target device.

Features:

- This product includes a debug chip (R7F702Z10AADB) for the RH850/E2UH and E2H groups.
- The combination of the emulation adapter connected to the base board included in the package is usable as a simple evaluation board.
- Using the emulation adapter with the exchange adapter allows connection to the target system and enables emulation of the target device.
- Connecting an emulator which supports Aurora tracing, such as the IE850A emulator (type name: RTE0T0850AKCT00000J) from Renesas, enables debugging.
- Using the attached 34-pin to 14-pin conversion connector enables connecting the emulation adapter to on-chip debugging emulators and flash programmers, such as the E2 emulator (type name: RTE0T00020KCE00000R) from Renesas.
- The emulation adapter can operate as a stand-alone unit, i.e. without connection to an emulator.

### 1.1 Package Components

The package of this product consists of the following items. After you have unpacked the box, check if your emulation adapter contains all of these items.

**Table 1-1 Package Components for the Emulation Adapter**

Item	Quantity
Emulation adapter: RTE7702012EAB00000J	1
Base board: RTE7702012EABBB000J	1
34-pin to 14-pin conversion adapter: RTE0T00020KCA30000J	1
Power-supply cable	1
Demounting lever	1
Jumper blocks for pin headers	5

## 1.2 Product Specifications

Table 1-2 lists the specifications of this product.

**Table 1-2 Product Specifications**

Item	Specification
Device to be emulated	468-pin BGA: RH850/E2UH 468-pin BGA: RH850/E2H 373-pin BGA: RH850/E2H
Power supply for the emulation adapter	4.5 V min., 5.0 V typ., 5.5 V max.
External dimension	Emulation adapter: 47 mm x 51 mm Base board: 100 mm x 120 mm
Weight	Emulation adapter: 22 g Base board: 79 g
Operating temperature	0 to 40°C (no condensation)
Storage temperature	-15 to 60°C (no condensation)
EMC	EU: EN55032 Class A, EN55024 USA: FCC part 15 Class A

### 1.3 Regulatory Compliance Notices

- European Union regulatory notices

This product complies with the following EU Directives. (These directives are only valid in the European Union.)

#### CE Certifications:

This product complies with the following European EMC standards.

- EMC Directive (2014/30/EU)

EN 55032 Class A

---

**WARNING:** This is a Class A product. This equipment can cause radio frequency noise when used in the residential area. In such cases, the user/operator of the equipment may be required to take appropriate countermeasures under his responsibility.

---

EN 55024

#### Information for traceability:

- Authorised representative & Manufacturer

Name: Renesas Electronics Corporation

Address: TOYOSU FORESIA, 3-2-24, Toyosu, Koto-ku, Tokyo, 135-0061, Japan

- Person responsible for placing on the market

Name: Renesas Electronics Europe GmbH

Address: Arcadiastrasse 10, 40472 Dusseldorf, Germany

- Trademark and Type name

Trademark: Renesas

Product name: RH850/E2x-FCC2 Emulation adapter + Base board

Type name: RTE7702012EAB00000J

#### Environmental Compliance and Certifications:

- Waste Electrical and Electronic Equipment (WEEE) Directive 2012/19/EU

- United States Regulatory notices on Electromagnetic compatibility

This product complies with the following EMC regulation. (This is only valid in the United States.)

**FCC Certifications:**

This equipment has been tested and found to comply with the limits for a Class A digital device, pursuant to Part 15 of the FCC Rules. These limits are designed to provide reasonable protection against harmful interference when the equipment is operated in a commercial environment. This equipment generates, uses, and can radiate radio frequency energy and, if not installed and used in accordance with the instruction manual, may cause harmful interference to radio communications. Operation of this equipment in a residential area is likely to cause harmful interference in which case the user will be required to correct the interference at his own expense.

This device complies with Part 15 of the FCC Rules. Operation is subject to the following two conditions: (1) this device may not cause harmful interference, and (2) this device must accept any interference received, including interference that may cause undesired operation.

---

**CAUTION:** Changes or modifications not expressly approved by the party responsible for compliance could void the user's authority to operate the equipment.

---

## 2. Names and Functions of Hardware

This chapter describes the names and functions of each part of the emulation adapter and of the other items included with it. You can avoid damaging the product and affecting the system by reading this chapter with reference to the actual hardware.

Chapter 3 shows a list of the settings of hardware according to the system configuration (type of usage).

### 2.1 Emulation Adapter (RTE7702012EAB0000J)

An emulation adapter is an emulation board on which the debug chip is mounted. Using the emulation adapter with the exchange adapter allows connection to the target system. The emulation adapter can also be used as a simple evaluation board in combination with the attached base board.

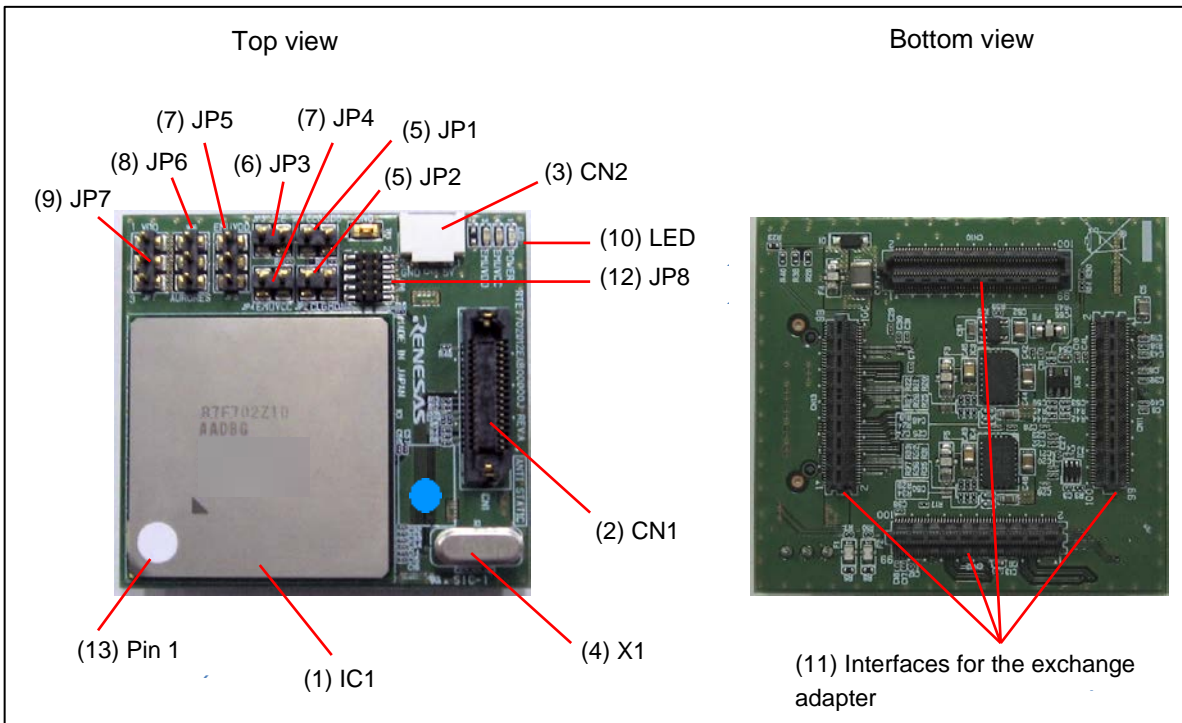

Figure 2-1 Names of the Parts of the Emulation Adapter (RTE7702012EAB0000J)

#### (1) Debug chip: IC1

IC1 is the debug chip (R7F702Z10AADB8G), which can emulate target devices of the RH850/E2UH and E2H groups.

**(2) Connector for external tracing: CN1**

CN1 is a connector for connection to emulators which support Aurora tracing, such as the IE850A emulator (type name: RTE0T0850AKCT00000J) from Renesas.

CN1 is a 34-pin connector from SAMTEC, the type name of which is ASP-137973-01. The table below lists the pin assignments.

Read the user's manual for the emulator you will be using and connect the emulator with this connector.



**Table 2-1 Pin Assignments of the Connector for External Tracing**

Signal Name	Pin No.	Pin No.	Signal Name
TODP0	1	2	TVCC (VCC)
TODN0	3	4	TCK
GND	5	6	TMS
TODP1	7	8	TDI
TODN1	9	10	TDO
GND	11	12	TRST
TODP2	13	14	MD0
TODN2	15	16	EVTI
GND	17	18	EVTO
TODP3	19	20	MD1
TODN3	21	22	RESET
GND	23	24	GND
MSYNZ	25	26	CICREFP
(WDTDIS)	27	28	CICREFN
GND	29	30	GND
(BREQ)	31	32	DRDY
(BGNT)	33	34	RESOUT

**(3) Power-supply connector: CN2**

CN2 is connected to the power-supply cable that comes with this product or that comes with the IE850A. When a base board is connected and emulation RAM (ERAM) or external tracing (Aurora tracing) is used, be sure to connect the power-supply cable to CN2 and supply +5 V.

When disconnecting the power-supply cable from the emulation adapter, press the tabs on both sides of the CN1 connector of the power-supply cable to unlock the connector.

 <b>CAUTION</b>	
Applied voltage:	
	Make sure that the voltage applied to CN2 is within the specified range (4.5 V to 5.5 V). An applied voltage out of the range may cause the emulation adapter to emit smoke or catch fire or otherwise be damaged.





Unlocking the connector:



Do not press the tabs for unlocking the connector too hard as this may lead to them being stuck in this position. Take care on this point.

#### (4) Clock socket: X1

X1 is the socket for the main oscillator. A 40-MHz oscillator is mounted upon the board as shipped.

Taking the oscillation characteristics into consideration, an oscillator on the target system is not used; the oscillator in this socket is used instead. Change the oscillator in the socket if this is required.

#### (5) Jumper blocks: JP2 (CLGMD1) and JP1 (CLGMD0)

JP2 (CLGMD1)	JP1 (CLGMD0)	Specification
Open-circuit (default)	Open-circuit (default)	400-MHz mode
Open-circuit	Short-circuit	Settings prohibited.
Short-circuit	Open-circuit	
Short-circuit	Short-circuit	

#### (6) Jumper block: JP3 (ICE)

JP3 (ICE)	Specification
Open-circuit (default)	ICE pin = low Security settings in the debug chip are enabled.
Short-circuit	ICE pin = high Security settings in the debug chip are partially disabled.

**(7) Jumper blocks: JP4 (EMUVCC) and JP5 (EMUVDD)**

JP4 (EMUVCC)	JP5 (EMUVDD)	Specification
Open-circuit	Open-circuit	Setting prohibited. EMUVCC = OFF, EMUVDD = always ON
Open-circuit	1-2 short-circuit	Setting prohibited. EMUVCC = OFF, EMUVDD = ON: Operation is with VCC.
Open-circuit	2-3 short-circuit	EMUVCC = OFF, EMUVDD = OFF This setting is enabled when neither ERAM nor external tracing (Aurora tracing) is to be used. At the same time, make JP6 (AURORES) open-circuit.
Short-circuit	Open-circuit	Setting prohibited. EMUVCC = ON, EMUVDD = always ON
<b>Short-circuit (default)</b>	<b>1-2 short-circuit (default)</b>	EMUVCC = ON, EMUVDD = ON: Operation is with VCC. This setting must be made when ERAM or external tracing (Aurora tracing) is to be used. At the same time, make 1-2 on JP6 (AURORES) short-circuit.
Short-circuit	2-3 short-circuit	Setting prohibited. EMUVCC = ON, EMUVDD = OFF

**(8) Jumper block: JP6 (AURORES)**

JP6 (AURORES)	Specification
Open-circuit	AURORES pin = low This setting is made when external tracing (Aurora tracing) is not to be used.
<b>1-2 short-circuit (default)</b>	The AURORES pin is operated by the TRST pin. When the emulator is connected, the level on the pin changes from low to high.
2-3 short-circuit	Setting prohibited. AURORES pin = high

Check that the setting is consistent with the form of operation selected by JP4 and JP5.

**(9) Jumper block: JP7 (VDD)**

JP7 (VDD)	Specification
Open-circuit	Setting prohibited.
<b>1-2 short-circuit (default)</b>	The power generated on the emulation adapter is supplied as VDD for the debug chip. This setting must be made when the emulation adapter is to be connected to the base board.
2-3 short-circuit	VDD on the target system is supplied as VDD for the debug chip. When this setting is to be used, refer to notes in section 4.2.3.

**(10) Status LEDs**

Name of LED	Specification
POWER	Illuminated: CN2 is supplying power. Not illuminated: CN2 is not supplying power.
EMUVCC	Illuminated: EMUVCC = ON Not illuminated: EMUVCC = OFF
EMUVDD	Illuminated: EMUVDD = ON Not illuminated: EMUVDD = OFF

**(11) Interfaces for the exchange adapter: CN10, CN11, CN12, and CN13**

These connectors are used to connect an exchange adapter or the base board. CN10 has a different shape from the others to prevent erroneous insertion.

**(12) Pin header: JP8**

JP8 is a pin header for the AUD-R pin.

**(13) Sticker for aligning the position of pin 1**

This mark indicates the position of pin 1 in the pad pattern for the device to be emulated on the target system.

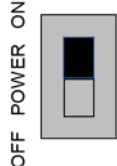
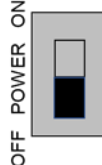

(2) Switch: SW1 (POWER SW)

SW1 (POWER SW)	Specification
<p>ON</p>  <p>SW1</p> <p>(default)</p>	<p>This switch turns on the power supply of the base board.</p> <p>Turn this switch on after connecting the emulation adapter and starting the supply of power from CN2 of the emulation adapter.</p>
<p>OFF</p>  <p>SW1</p>	<p>This switch turns off the power supply of the base board.</p>

 **CAUTION**



Operating the switch:

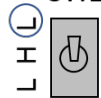
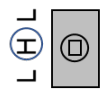
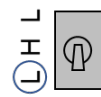

Do not operate a switch before removing static electricity from the operator's body. Doing so may lead to the discharge of static electricity and so damage the internal circuits.

(3) Switch: SW2 (RESET SW)

SW2 (RESET SW)	Specification
<p>(L)</p>  <p>SW2</p> <p>RESET</p>	<p>This position starts release from the reset state after the debug chip has been reset.</p> <p>The switch returns to the "H" position a moment after it stops being pressed.</p> <p>The state of the reset pin of the debug chip changes from "L" to "H" (pulled up).</p>
<p>H</p>  <p>SW2</p> <p>RESET</p> <p>(default)</p>	<p>Reset released state.</p> <p>The reset pin of the debug chip is in the "H" (pulled up) state.</p>
<p>L</p>  <p>SW2</p> <p>RESET</p>	<p>Reset state.</p> <p>The reset pin of the debug chip is in the "L" state.</p>

 <b>CAUTION</b>	
Operating the switch:	
	Do not operate a switch before removing static electricity from the operator's body. Doing so may lead to the discharge of static electricity and so damage the internal circuits.

**(4) Status LEDs: LED1 (3.3 V) and LED2 (5 V)**

Name of LED	Specification
LED1 (3.3 V)	Illuminated: The 3.3-V power supply on the base board is on. Not illuminated: The 3.3-V power supply on the base board is off.
LED2 (5 V)	Illuminated: The 5-V power supply on the base board is on. Not illuminated: The 5-V power supply on the base board is off.

**(5) Jumper blocks: JP1 to JP16 (selecting each of the power-supply voltages)**

The target power-supply voltages for each of these jumper blocks are listed below.

JP	Target Power-Supply Voltage
JP1	ADSVCC
JP2	ADSVRFFH
JP3	A0VCC
JP4	A1VCC
JP5	A2VCC
JP6	A3VCC
JP7	A0VREFFH
JP8	A1VREFFH
JP9	A2VREFFH
JP10	A3VREFFH
JP11	E0VCC
JP12	E1VCC
JP13	E2VCC
JP14	LVDVCC
JP15	YSVCC
JP16	VCC

Each jumper block has common specifications as shown in the following table.

JP1 to JP11	Specification
Open-circuit	The target power-supply voltage is off.
<b>1-2 short-circuit (default)</b>	5 V is supplied as the target power-supply voltage.

Each jumper block has common specifications as shown in the following table.

JP12 to JP16	Specification
Open-circuit	The target power-supply voltage is off.
<b>1-2 short-circuit (default)</b>	5 V is supplied as the target power-supply voltage.
2-3 short-circuit	3.3 V is supplied as the target power-supply voltage.

**(6) Jumper block: JP17 (MD0)**

JP17 (MD0)	Specification
<b>Open-circuit (default)</b>	MD0 pin = "L" (pulled down)
Short-circuit	MD0 pin = "H" (pulled up)

**(7) Jumper block: JP18 (MD1)**

JP18 (MD1)	Specification
<b>Open-circuit (default)</b>	MD1 pin = "L" (pulled down)
Short-circuit	MD1 pin = "H" (pulled up)

**(8) Silk-screened mark for aligning the position of pin 1**

When connecting the emulation adapter, match the position of the sticker for aligning the position of pin 1 on the emulation adapter with that of the silk-screened mark for aligning the position of pin 1 on the base board.





### 2.3 34-Pin to 14-Pin Conversion Adapter (RTE0T00020KCA30000J)

The conversion adapter is an adapter board that is used to connect an emulator with a 14-pin connector to the emulation adapter and is required for debugging in such situations.

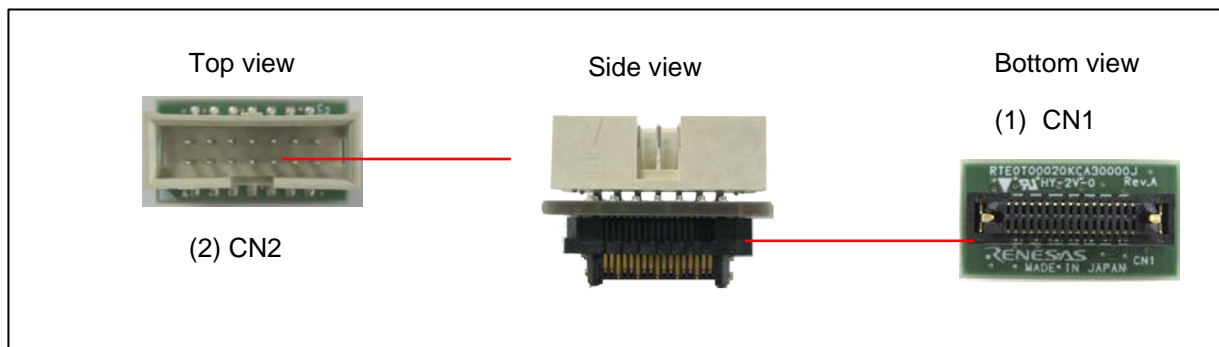

**Figure 2-4** Names of the Parts of the 34-Pin to 14-Pin Conversion Adapter (RTE0T00020KCA30000J)

#### (1) Connector: CN1 (34-pin side)

CN1 can be connected to CN1 for external tracing through the emulation adapter.

#### (2) Connector: CN2 (14-pin side)

CN2 is a 14-pin connector that is defined as a connector for the RH850 emulators. This connector can be connected to on-chip debugging emulators such as the E2 emulator (type name: RTE0T00020KCE00000R) from Renesas and flash programmers that support the 14-pin connector.

The following shows pin assignments of CN2. Read the user's manual for the emulator you will be using and connect the emulator with this connector.

**Table 2-2** Pin Assignments of the 14-Pin Connector (CN2)

Signal Name	Pin No.	Pin No.	Signal Name
TCK/LPDCLK	1	2	GND
TRST	3	4	FPMD0 (MD0)
TDO/LPDO	5	6	FPMD1 (MD1)
TDI/LPDIO	7	8	TVDD (VCC)
TMS	9	10	EVTO
DRDY/LPDCLKO	11	12	GND
RESET	13	14	GND

## 2.4 Power-Supply Cable

The power-supply cable (about 300-mm long) supplies power to the emulation adapter.

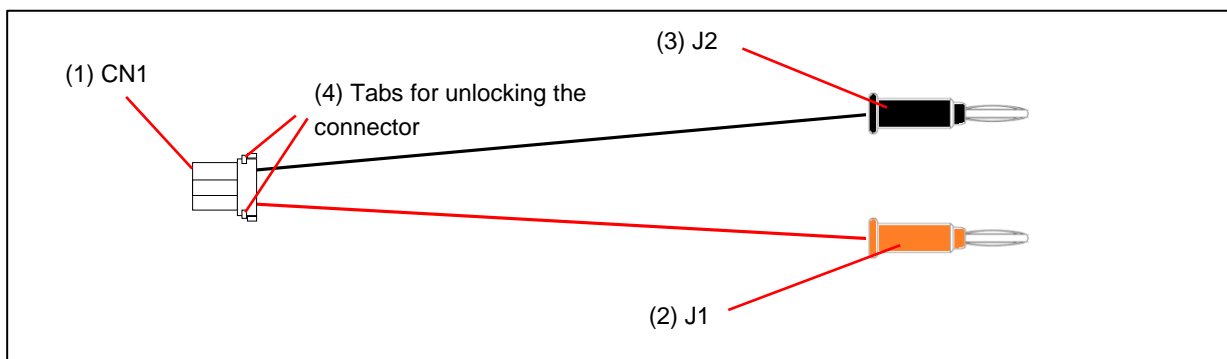

Figure 2-5 Names of the Parts of the Power-Supply Cable

### (1) Connector: CN1

CN1 is a connector (LEAR-02V-S from JST) for connection to CN2 of the emulation adapter.

### (2) Power jack: J1 (red)

Supply 5 V from a stabilized power supply.

### (3) Power jack: J2 (black)

Connect J2 to GND.

### (4) Tabs for unlocking the connector

When disconnecting the power-supply cable from the emulation adapter, press the tabs on both sides of the CN1 connector of the power-supply cable to unlock the connector.

 <b>CAUTION</b>	
Unlocking the connector:	
	Do not press the tabs for unlocking the connector too hard as this may lead to them being stuck in this position. Take care on this point.

## 2.5 Demounting Lever

The demounting lever which comes with this product is used to remove the emulation adapter from the base board or exchange adapter.

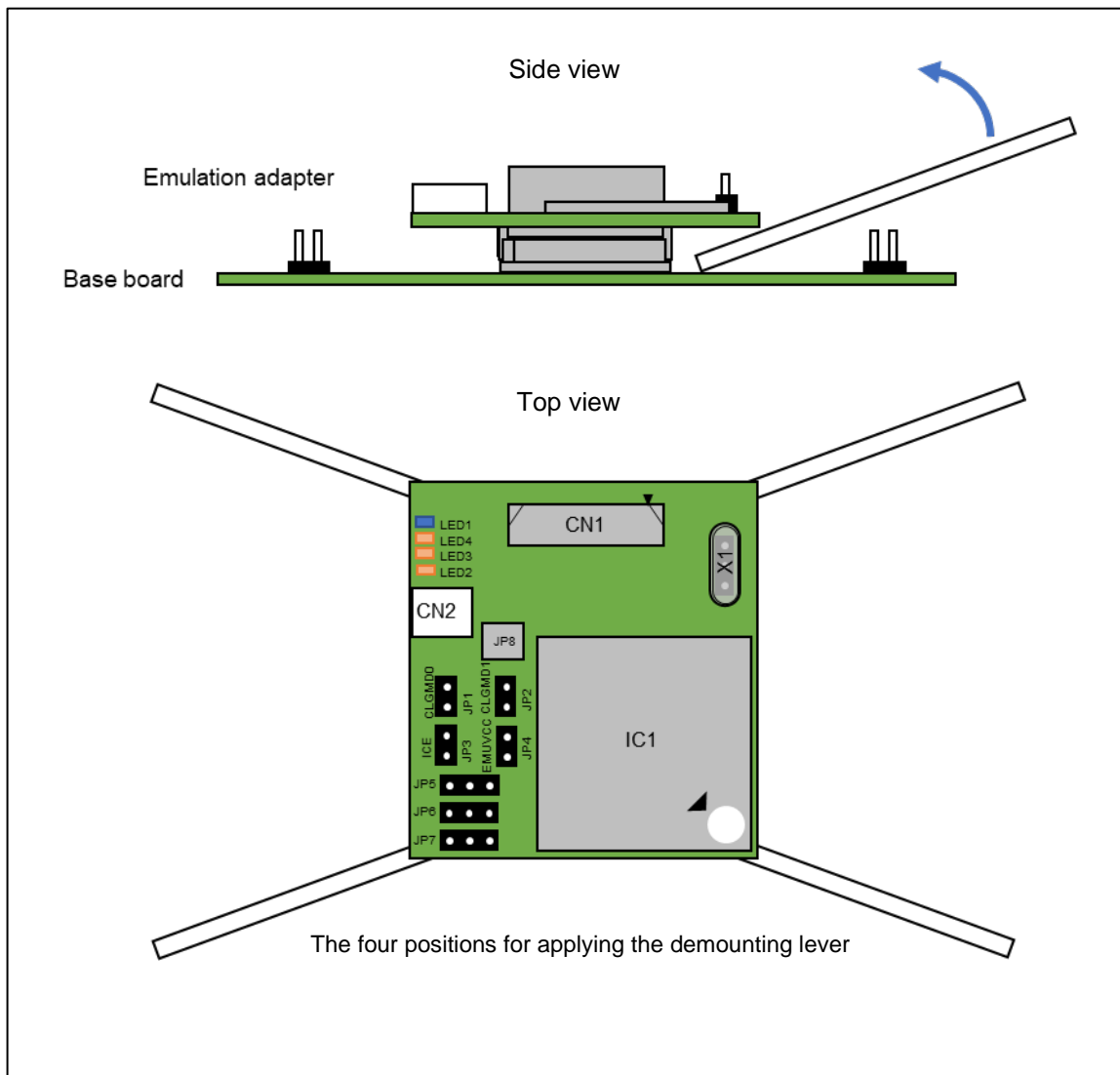



Figure 2-6 Demounting Lever

To remove the emulation adapter from the base board or exchange adapter, insert the demounting lever alternately below all four corners of the emulation adapter and gradually pull the emulation adapter out.

 <b>CAUTION</b>	
Point for caution on removing the emulation adapter:	
	When you remove the emulation adapter from the base board or exchange adapter, take care not to damage or deform peripheral components.

### 3. System Configuration and Setup

The system configurations of this emulation adapter are as follows according to your intentions in using it.

- A simple evaluation board (See section 3.1.)
- An emulation board (See section 3.2.)

#### 3.1 System Configuration as a Simple Evaluation Board

Figure 3-1 shows a system configuration when the emulation adapter is connected to the base board for use as a simple evaluation board. Connection of an emulator is not essential.

Using the pin headers on the base board enables the control and monitoring of each pin of the target device.

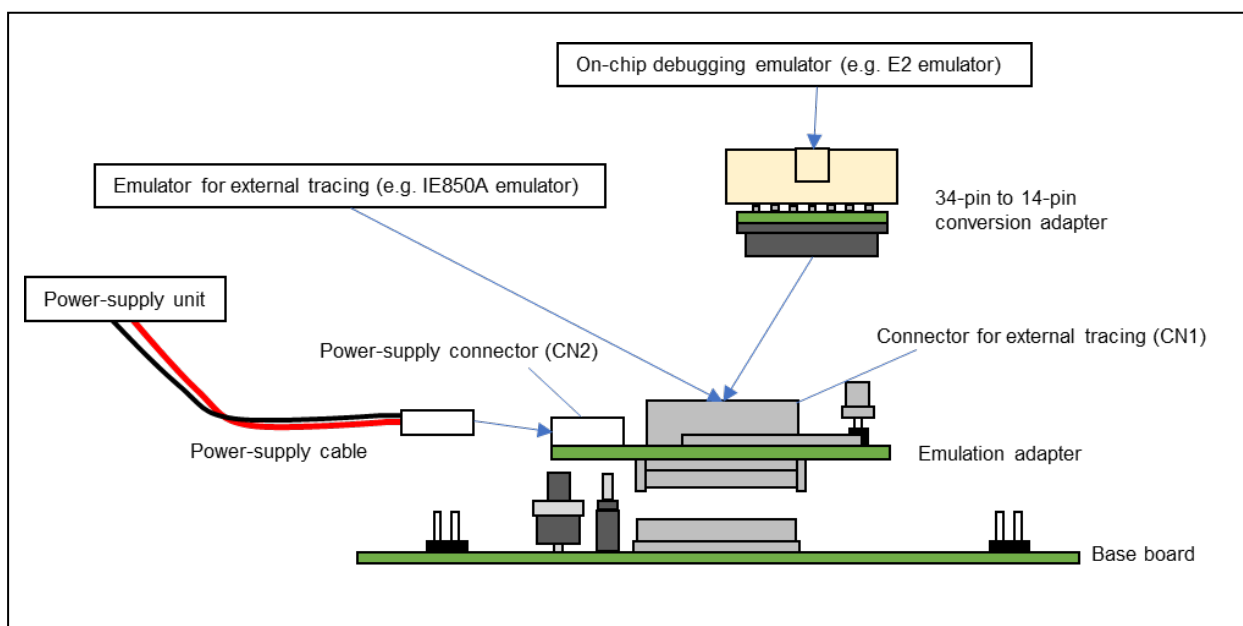

Figure 3-1 System Configuration (Simple Evaluation Board)

### 3.1.1 Settings for Use as a Simple Evaluation Board

Table 3-1 and Table 3-2 show lists of the recommended settings for this system configuration.

**Table 3-1 Settings for Use as a Simple Evaluation Board (Emulation Adapter)**

Item	Description
Debug chip: IC1	Set an option byte. Refer to section 4.1.
Connector for external tracing: CN1	When an emulator is in use: Connect the cable for the emulator or the 34-pin to 14-pin conversion adapter.
	When an emulator is not in use: Leave the connector open-circuit.
Power-supply connector: CN2	Set up a +5-V supply through the attached power-supply cable. If you are using the IE850A, power can be supplied from the power-supply cable attached to the IE850A.
Clock socket: X1	An oscillator is mounted (40 MHz at shipment). When you are evaluating the emulation adapter with a main oscillator that has a different frequency (e.g. 20 MHz), change the oscillator.
Jumper blocks: JP2 (CLGMD1) and JP1 (CLGMD0)	We recommend making JP2 and JP1 open-circuit. Refer to (5) in section 2.1.
Jumper block: JP3 (ICE)	We recommend making JP3 open-circuit. Refer to (6) in section 2.1.
Jumper blocks: JP4 (EMUVCC) and JP5 (EMUVDD)	We recommend making JP4 and 1-2 on JP5 short-circuit. Refer to (7) in section 2.1.
Jumper block: JP6 (AURORES)	We recommend making 1-2 on JP6 short-circuit. Refer to (8) in section 2.1.
Jumper block: JP7 (VDD)	Be sure to make 1-2 on JP7 short-circuit. Refer to (9) in section 2.1.
Interfaces for the exchange adapter: CN10, CN11, CN12, and CN13	Connect these connectors to the base board.

**Table 3-2 Settings for Use as a Simple Evaluation Board (Base Board)**

Item	Description
Interfaces for the exchange adapter: CN10, CN11, CN12, and CN13	Connect these connectors to the emulation adapter.
Switch: SW1 (POWER SW)	Refer to (2) in section 2.2.
Switch: SW2 (RESET SW)	Refer to (3) in section 2.2.
Jumper blocks: JP1 to JP16 (selecting each of the power-supply voltages)	The voltage of each power supply is selected according to the conditions to be evaluated or the specifications of the target device. Refer to (5) in section 2.2.
Jumper block: JP17 (MD0)	We recommend making JP17 open-circuit. Refer to (6) in section 2.2.
Jumper block: JP18 (MD1)	We recommend making JP18 open-circuit. Refer to (7) in section 2.2.

### 3.1.2 Procedure for Setting the Emulation Adapter up as a Simple Evaluation Board

This section describes the procedure for setting the emulation adapter up for use as a simple evaluation board.

#### (1) Settings on the boards

Make settings for the emulation adapter and base board according to the statements in section 3.1.1. Turn off the SW1 switch (POWER SW) on the base board and set the SW2 switch (RESET SW) for the low level.

#### (2) Connecting the power-supply cable

Connect the power-supply cable which comes with this product to the CN2 power-supply connector of the emulation adapter then connect a power-supply unit such as a stabilized power supply. Do not turn the power on.



If you are using an IE850A emulator, power can be supplied by connecting the power-supply cable attached to the IE850A.

#### (3) Connecting the emulation adapter to the base board

Connect the two boards so that the sticker and silk-screened mark for aligning the positions of pin 1 of the emulation adapter and base board are in the same position.

#### (4) Connecting the emulator (only if you are using an emulator)

Connect the emulator to the CN1 connector for external tracing from the emulation adapter. If you are using an emulator (e.g. an IE850A) that supports external tracing (Aurora tracing), directly connect the emulator cable. If you are using an emulator (e.g. an E2) that supports a 14-pin connector, connect the emulator via the 32-pin to 14-pin conversion adapter.

 <b>CAUTION</b>	
Connecting the emulator:	
	Confirm the direction with the notch on the connector and connect the emulator while taking care that the direction of insertion is correct.

#### (5) Turning on the emulator (only if you are using an emulator)



Turn on the emulator. For details, refer to the manuals for the emulator you are using.

**(6) Turning on the emulation adapter and base board and releasing a reset**

Output 5 V from the power-supply unit that is connected to the power-supply connector (CN2) of the emulation adapter and turn the switch (SW1; POWER SW) of the base board on. Then, set SW2 (RESET SW) for the high level.

Accordingly, if an emulator is not connected, the debug chip will start executing a program.

When the emulator is connected, the debug chip will be kept in the reset state before execution of a program is started by the debugger after the debugger has been launched, although this depends on the specifications of the emulator.

 <b>CAUTION</b>	
Applied voltage:	
	Make sure that the voltage applied to CN2 is within the specified range (4.5 V to 5.5 V). An applied voltage out of the range may cause the emulation adapter to emit smoke or catch fire or otherwise be damaged.

**(7) Launching the debugger (only if you are using an emulator)**

Launch the debugger to start debugging. The first time this is done, an option byte must be set according to the target device to be emulated.

### 3.1.3 Procedure for Closing a Session of Use as a Simple Evaluation Board

This section describes the procedure for closing a session of using the emulation adapter as a simple evaluation board.

#### (1) Closing the debugger (only if you are using an emulator)

Close the debugger.

#### (2) Turning off and resetting the emulation adapter and base board

Set SW2 (RESET SW) of the base board for the low level. Turn the switch (SW1; POWER SW) of the base board off. Turn off the output from the power-supply unit that is connected to the power-supply connector (CN2) of the emulation adapter.

#### (3) Turning off the emulator (only if you are using an emulator)

Turn off the emulator. For details, refer to manuals for the emulator you are using.

Take the steps below as required.

#### (4) Disconnecting the emulator (only if you are using an emulator)

Disconnect the emulator from the emulation adapter.

#### (5) Disconnecting the emulation adapter from the base board

To disconnect the emulation adapter from the base board, insert the demounting lever which comes with this product into alternate corners among the four corners between the two boards and gradually pull the emulation adapter out. Take care of the positions where you insert the demounting lever so that you do not accidentally tear off components on the boards. For details, refer to section 2.5.

#### (6) Disconnecting the power-supply cable

Disconnect the power-supply cable from the CN2 power-supply connector of the emulation adapter. When disconnecting the power-supply cable from the emulation adapter, press the tabs on both sides of the CN1 connector of the power-supply cable to unlock the connector.

### CAUTION

Unlocking the connector:



Do not press the tabs for unlocking the connector too hard as this may lead to them being stuck in this position. Take care on this point.



### 3.2 System Configuration as an Emulation Board

Figure 3-2 shows a system configuration when the emulation adapter is to be connected to the exchange adapter then connected to a target board (the base board is not used). For the specifications of the exchange adapter, refer to appendix A, Specifications of the Exchange Adapter.

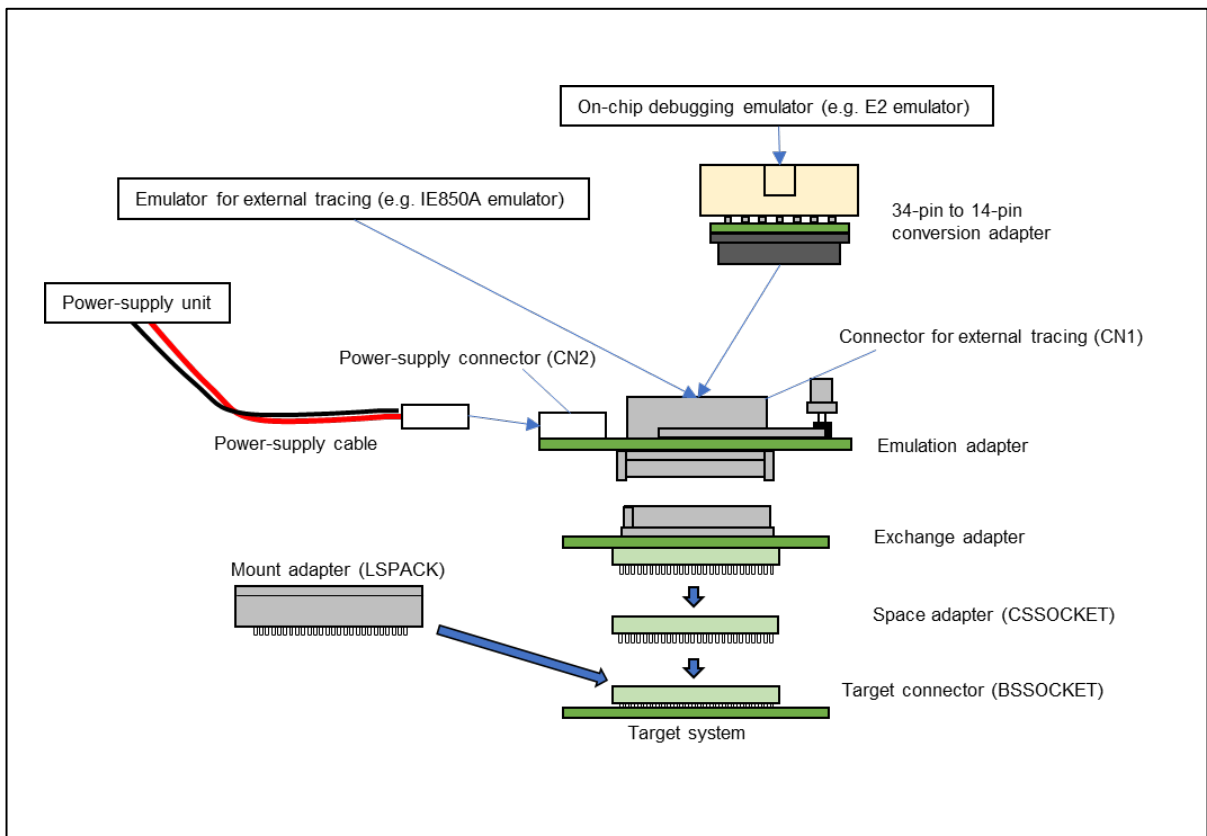

Figure 3-2 System Configuration (Emulation Board)

### 3.2.1 List of Exchange Adapters and Sockets

Table 3-3 lists the exchange adapters and sockets for the target devices. They are sold separately from this product. For the BGA packages, the BSSOCKET target connectors, CSSOCKET space adapters, and LSPACK mounting adapters can be purchased from Tokyo Eletech Corporation. The exchange adapters can be purchased from Renesas Electronics Corporation. If you particularly require details on the CSSOCKET space adapter, contact Tokyo Eletech Corporation.

**Table 3-3 Exchange Adapters and Sockets**

Package Device	Exchange Adapter	Target Connector	Space Adapter	Mount Adapter
BGA468 RH850/E2UH RH850/E2H	RTE7702012CBG468T000J	BSSOCKET468A3025RE21N	CSSOCKET468A3025RE03 CSSOCKET468A3025RE04	LSPACK468A3025RE01
BGA373 RH850/E2H	RTE7702011CBG373T000J	BSSOCKET373A2521RE21N	CSSOCKET373A2521RE03 CSSOCKET373A2521RE04	LSPACK373A2521RE01

BSSOCKET target connector (required for emulation):

This connector is for mounting on the target system.

Exchange adapter (required for emulation):

This conversion adapter is for connecting the emulation adapter to the target connector.

CSSOCKET space adapter (optional):

This adapter is used to adjust the height. It is an optional product which is available for use if the components around the target connector would otherwise touch the exchange adapter or emulation adapter.

LSPACK mount adapter (optional):

When the target device is mounted on the target connector, this adapter is required as a cover.

### 3.2.2 Settings for Use as an Emulation Board

Table 3-4 and Table 3-5 show lists of the recommended settings of the emulation adapter in this system configuration. For the settings when the power is supplied from CN2, refer to Table 3-4. If the power is not supplied from CN2, the settings in Table 3-5 are also required. When you select a configuration in which the power is not supplied from CN2, note that neither ERAM nor external tracing (Aurora tracing) is available.

**Table 3-4 Settings for Use as an Emulation Board when the Power is to be Supplied from CN2**

Item	Description
Debug chip: IC1	Set an option byte. Refer to section 4.1.
Connector for external tracing: CN1	When an emulator is in use: Connect the cable for the emulator or the 34-pin to 14-pin conversion adapter.
	When an emulator is not in use: Leave the connector open-circuit.
Power-supply connector: CN2	Set up a +5-V supply through the attached power-supply cable. If you are using the IE850A, power can be supplied from the power-supply cable attached to the IE850A.
Clock socket: X1	An oscillator is mounted (40 MHz at shipment). When you are evaluating the emulation adapter with a main oscillator that has a different frequency (e.g. 20 MHz), change the oscillator.
Jumper blocks: JP2 (CLGMD1) and JP1 (CLGMD0)	We recommend making JP2 and JP1 open-circuit. Refer to (5) in section 2.1.
Jumper block: JP3 (ICE)	We recommend making JP3 open-circuit. Refer to (6) in section 2.1.
Jumper blocks: JP4 (EMUVCC) and JP5 (EMUVDD)	We recommend making JP4 and 1-2 on JP5 short-circuit. Refer to (7) in section 2.1.
Jumper block: JP6 (AURORES)	We recommend making 1-2 on JP6 short-circuit. Refer to (8) in section 2.1.
Jumper block: JP7 (VDD)	We recommend making 1-2 on JP7 short-circuit. Refer to (9) in section 2.1.
Interfaces for the exchange adapter: CN10, CN11, CN12, and CN13	Connect these connectors to the exchange adapter.

**Table 3-5 Settings for Use as an Emulation Board when the Power is not to be Supplied from CN2**

Item	Description
Debug chip: IC1	Set an option byte. Refer to section 4.1.
Connector for external tracing: CN1	When an emulator is in use: Connect the cable for the emulator or the 34-pin to 14-pin conversion adapter.
	When an emulator is not in use: Leave the connector open-circuit.
Power-supply connector: CN2	Leave the connector open-circuit.
Clock socket: X1	An oscillator is mounted (40 MHz at shipment). When you are evaluating the emulation adapter with a main oscillator that has a different frequency (e.g. 20 MHz), change the oscillator.
Jumper blocks: JP2 (CLGMD1) and JP1 (CLGMD0)	We recommend making JP2 and JP1 open-circuit. Refer to (5) in section 2.1.
Jumper block: JP3 (ICE)	We recommend making JP3 open-circuit. Refer to (6) in section 2.1.
Jumper blocks: JP4 (EMUVCC) and JP5 (EMUVDD)	Be sure to make JP4 open-circuit and 2-3 on JP5 short-circuit. Refer to (7) in section 2.1.
Jumper block: JP6 (AURORES)	Be sure to make JP6 open-circuit. Refer to (8) in section 2.1.
Jumper block: JP7 (VDD)	Be sure to make 2-3 on JP7 short-circuit. Refer to (9) in section 2.1.
Interfaces for the exchange adapter: CN10, CN11, CN12, and CN13	Connect these connectors to the exchange adapter.

### 3.2.3 Procedure for Setting the Emulation Adapter up as an Emulation Board

This section describes the procedure for setting the emulation adapter up for use as an emulation board.

#### (1) Settings on the boards

Make settings for the emulation adapter according to the statements in section 3.2.2.

#### (2) Connecting the power-supply cable (when the power is supplied from CN2)

Connect the power-supply cable which comes with this product to the CN2 power-supply connector of the emulation adapter then connect a power-supply unit such as a stabilized power supply. Do not turn the power on.

If you are using an IE850A emulator, power can be supplied by connecting the power-supply cable attached to the IE850A.

#### (3) Connecting the emulation adapter to the exchange adapter

Connect the two boards so that the positions of pin 1 of the emulation adapter and of the exchange adapter are in the same position.

#### (4) Connecting the exchange adapter to the target system

The target connector (BSSOCKET) must be mounted on the pad pattern for the target device of the target system in advance.

After that, connect the exchange adapter to the target connector mounted on the target system.

 **CAUTION**

Connecting the exchange adapter:



Connect the exchange adapter to the target system by aligning the positions of pin 1 of the target connector and of the exchange adapter and confirming that the contact pins of the exchange adapter are not bent.

**(5) Connecting the emulator (only if you are using an emulator)**

Connect the emulator to the CN1 connector for external tracing from the emulation adapter. If you are using an emulator (e.g. an IE850A) that supports external tracing (Aurora tracing), directly connect the emulator cable. If you are using an emulator (e.g. an E2) that supports a 14-pin connector, connect the emulator via the 32-pin to 14-pin conversion adapter.

 **CAUTION**

Connecting the emulator:



Confirm the direction with the notch on the connector and connect the emulator while taking care that the direction of insertion is correct.

**(6) Turning on the emulator (only if you are using an emulator)**

Turn on the emulator. For details, refer to the manuals for the emulator you are using.

**(7) Turning on the emulation adapter**

Output 5 V from the power-supply unit that is connected to the power-supply connector (CN2) of the emulation adapter.

 **CAUTION**

Applied voltage:



Make sure that the voltage applied to CN2 is within the specified range (4.5 V to 5.5 V).

An applied voltage out of the range may cause the emulation adapter to emit smoke or catch fire or otherwise be damaged.

**(8) Turning on the target system**

Turn on the target system.

**(9) Launching the debugger (only if you are using an emulator)**

Launch the debugger to start debugging. The first time this is done, an option byte must be set according to the target device to be emulated.

### 3.2.4 Procedure for Closing a Session of Use as an Emulation Board

This section describes the procedure for closing a session of using the emulation adapter as an emulation board.

#### (1) Closing the debugger (only if you are using an emulator)

Close the debugger.

#### (2) Turning off the target system

Turn off the target system.

#### (3) Turning off the emulation adapter

Stop the 5-V output from the power-supply unit that is connected to the power-supply connector (CN2) of the emulation adapter.

#### (4) Turning off the emulator (only if you are using an emulator)

Turn off the emulator. For details, refer to manuals for the emulator you are using.

Take the steps below as required.

#### (5) Disconnecting the emulator (only if you are using an emulator)

Disconnect the emulator from the emulation adapter.

#### (6) Disconnecting the emulation adapter from the exchange adapter

To disconnect the emulation adapter from the exchange adapter, insert the demounting lever which comes with this product into alternate corners among the four corners between the two boards and gradually pull the emulation adapter out. Take care of the positions where you insert the demounting lever so that you do not accidentally tear off components on the boards. For details, refer to section 2.5.

#### (7) Disconnecting the exchange adapter from the target system

Disconnect the exchange adapter from the target system.

For details, refer to appendix A, Specification of the Exchange Adapter.

#### (8) Disconnecting the power-supply cable (when the power is supplied from CN2)

Disconnect the power-supply cable from the CN2 power-supply connector of the emulation adapter. When disconnecting the power-supply cable from the emulation adapter, press the tabs on both sides of the CN1 connector of the power-supply cable to unlock the connector.

### CAUTION

Unlocking the connector:



Do not press the tabs for unlocking the connector too hard as this may lead to them being stuck in this position. Take care on this point.

## 4. Notes

### 4.1 Setting Option Bytes

Although the specifications of the option bytes of the debug chip which is mounted on the emulation adapter are the same as those of the target device, the actual settings at the time of shipment may differ.

Specify appropriate values for the option bytes of the debug chip according to the user's manual for the target device.

In particular, the values of the following option bytes must be specified to suit the device to be emulated.

#### 4.1.1 OPBT9

OPBT9 is an option byte which only requires setting in the case of the debug chip. Set OPBT9 according to the device to be emulated before starting debugging.

Option byte OPBT9:

Address: FF32 00A4H

Default value: FFFF FFFAH (for emulation of the E2UH)

Setting value: FFFF FFF8H (for emulation of the E2H)

#### 4.1.2 OPBT3

OPBT3 defines the CPUs which are to be enabled. Since the debug chip emulates the E2UH, which has six CPUs, disable the unnecessary CPUs (set the PEx\_DISABLE to 1) through the setting of OPBT3.

## 4.2 Notes on Differences between the Actual Device and the Emulation Adapter

### 4.2.1 Current Drawn

When the emulation adapter is in use, current drawn may differ from that for the actual device. Thus, the customer should use the actual device in a final evaluation before mass production and judge the suitability of adopting the product on that basis.

### 4.2.2 Oscillator

The emulation adapter does not support clock input from an oscillator on the target system. The main clock oscillator on the emulation adapter is used as the main clock. The emulation adapter only supports the main OSC crystal resonator but not external clock input.

Proceed with final evaluation to confirm operation of the target system after mounting the actual device and while using the oscillator on the target system.

### 4.2.3 Power-Supply Voltages

The debug chip mounted on the emulation adapter basically operates with the power supplied from the target system. However, note that there are differences in the following power-supply voltages.

- EMUVDD and EMUVCC are generated on the emulation adapter.
- Whether the power-supply voltage generated on the emulation adapter or that for the target system is used for VDD is selectable by the setting of JP7 on the emulation adapter.

When you use the power supply from the target system, note that transient drops in the power-supply voltage may occur.

### 4.2.4 VSS Pins for Each Power-Supply Voltage

AxVSS, ADSVSS, and VSS are connected to a common GND in the emulation adapter.

### 4.2.5 RAMSVCL and ADSVCL Pins

Stabilizing capacitors are connected to the stabilizing capacitor connection pins (RAMSVCL and ADSVCL) on the emulation adapter. These pins are not connected on the target system.

### 4.2.6 A/D Converter

Results from the A/D converter may differ from those on the actual device because of the exchange adaptor etc. between the debug chip and the target system.

### 4.2.7 Double-Mapping Mode

The emulation adapter is not capable of emulating the double-mapping mode for the target device.



## 5. Characteristics of Target Interface

The target interface behaves as if the actual device is connected in terms of functionality. However, in terms of characteristics, the behavior of the target interface sometimes differs from the behavior when the actual device is connected. Figure 5-1 shows an equivalent circuit of this product.

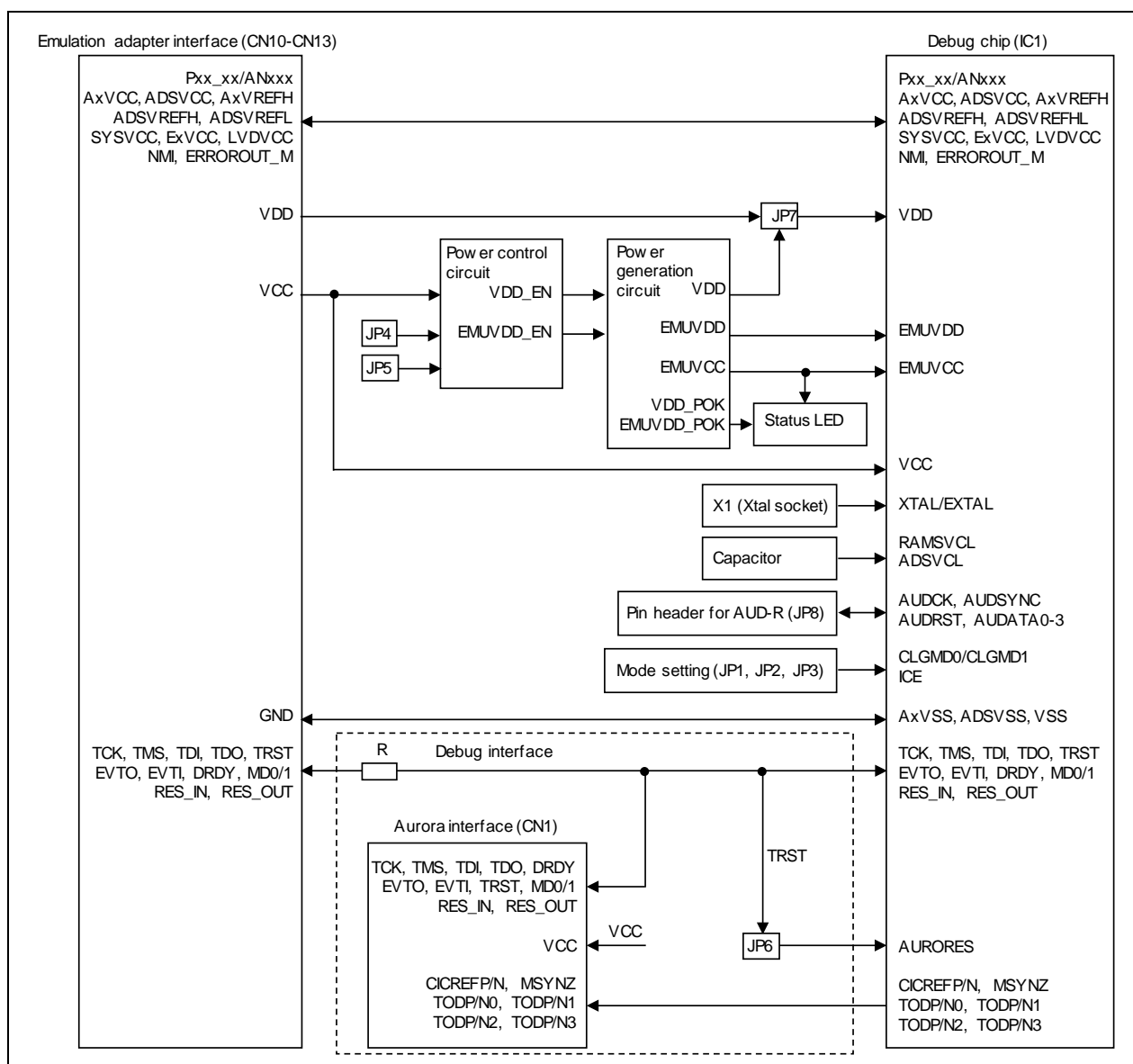

Figure 5-1 Equivalent Circuit of the Emulation Adapter

## 6. Maintenance and Warranty

This chapter covers basic maintenance, warranty information, provisions for repair and the procedures for requesting a repair. For information on the exchange adapter and socket products, refer to appendix A, Specifications of the Exchange Adapter.

### 6.1 Maintenance

- (1) If dust or dirt collects on this product, wipe it off with a dry soft cloth. Do not use thinner or other solvents because these chemicals can cause the surface coating to separate.
- (2) When you do not use this product for a long period, disconnect it from the power supply, host machine, and target system.

### 6.2 Warranty

- (1) This product comes with a one-year warranty after purchase.  
Should the product break down or be damaged while you're using it under normal conditions in accord with its user's manual, it will be repaired or replaced free of cost.
- (2) However, if the following types of failure or damage to the product occur during the term of the warranty, repairing or replacing the product will incur a cost.
  - a) Failure or damage attributable to the misuse or abuse of the product or its use under other abnormal conditions.
  - b) Failure or damage attributable to improper handling of the product after purchase, such as dropping the product while it is being transported or otherwise moved.
  - c) Failure or damage to the product caused by other pieces of equipment connected to it.
  - d) Failure or damage attributable to fire, earthquakes, thunderbolts, floods, or other natural disasters, or to abnormal voltages, etc.
  - e) Failure or damage attributable to modifications, repairs, adjustments, or other acts in relation to the product by parties other than Renesas Electronics Corp.
- (3) Consumables (e.g., sockets and adaptors) are beyond the scope of repair and replacement.

In the above cases, contact your local distributor. If you are renting the product, consult the company you are renting it from or the owner.

### 6.3 Repair Provisions

- (1) Repairs not covered by warranty  
Problems arising in products for which more than one year has elapsed since purchase are not covered by warranty.
- (2) Replacement not covered by warranty  
If your product's fault falls into any of the following categories, the fault will be corrected by replacing the entire product instead of repairing it, or you will be advised to purchase a new product, depending on the severity of the fault.
  - Faulty or broken mechanical portions
  - Flaws, separation, or rust in coated or plated portions
  - Flaws or cracks in plastic portions
  - Faults or breakage caused by improper use or unauthorized repair or modification
  - Heavily damaged electric circuits due to overvoltage, overcurrent or shorting of power supply

- Cracks in the printed circuit board or burnt-down patterns
  - A wide range of faults that make replacement less expensive than repair
  - Faults that are not locatable or identifiable
- (3) Expiration of the repair period
- We accept requests for repairs up to three years after production of a given model has ceased.
  - Repairing a given model may become impossible even during the above period if the parts required for the repairs are no longer available.
- (4) Carriage fees for sending your product to be repaired
- Carriage fees for sending your product to us for repair are at your own expense.

## 6.4 How to Request Repairs

If your product is found faulty, fill in a Repair Request Sheet downloadable from the following URL and email the sheet and send the product to your local distributor.

<http://www.renesas.com/repair>

### CAUTION

Note on Transporting the Product:



When sending your product for repair, use the packing box and cushioning material supplied with the MCU unit when it was delivered to you and specify caution in handling (handling as precision equipment). If packing of your product is not complete, it may be damaged during transportation. When you pack your product in a bag, make sure to use the conductive plastic bag supplied with the MCU unit (usually a blue bag). If you use a different bag, it may lead to further trouble with your product due to static electricity.

## Appendix A Specifications of the Exchange Adapter

### (1) Overview

An exchange adapter is an adapter board that connects the emulation adapter to the pad pattern for the target device.

The following describes the specifications of the RTE7702012CBG468T000J exchange adapter for the 468-pin BGA package and the RTE7702011CBG373T000J exchange adapter for the 373-pin BGA package.

### (2) List of Packages and Sockets

Table A-1 lists the exchange adapters and type names of sockets for the packages of the target devices. The BSSOCKET target connector, CSSOCKET space adapter, and LSPACK mount adapter can be purchased from Tokyo Eletech Corporation. If you particularly require details on the CSSOCKET space adapter, contact Tokyo Eletech Corporation.

**Table A-1 Exchange Adapters and Sockets for the Packages of the Target Devices**

Package	Exchange Adapter	Target Connector	Space Adapter	Mount Adapter
FBGA-468 0.8-mm ball pitch	RTE7702012CBG468T000J	BSSOCKET468A3025RE21N	CSSOCKET468A3025RE03 CSSOCKET468A3025RE04	LSPACK468A3025RE01
FBGA-373 0.8-mm ball pitch	RTE7702011CBG373T000J	BSSOCKET373A2521RE21N	CSSOCKET373A2521RE03 CSSOCKET373A2521RE04	LSPACK373A2521RE01

### (3) Number of insertions and removals of the connector

The connector is guaranteed for correct insertion and removal 100 times.

### (4) How to use the emulation adapter

The emulation adapter can be connected to the target system via the exchange adapter through the following procedure. Align the positions of pin 1 as shown in Figure A-1.

1. Mount the target connector (BSSOCKET) on the target system.
2. Connect the exchange adapter to the emulation adapter.
3. Connect the exchange adapter to the target connector (BSSOCKET).
  - If adjustment of the height is required, use the space adapter (CSSOCKET).
  - Confirm that the contact pins are not bent.

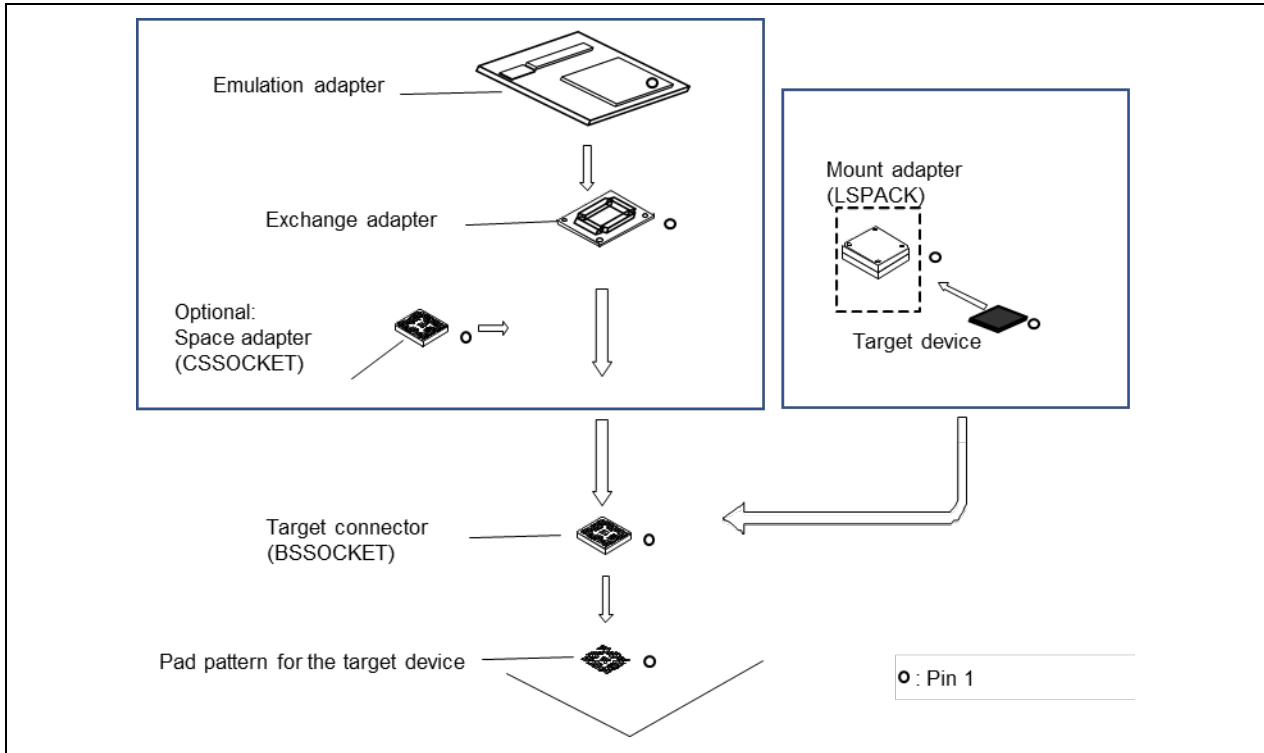

Figure A-1 Connecting the Emulation Adapter

(5) Dimensions

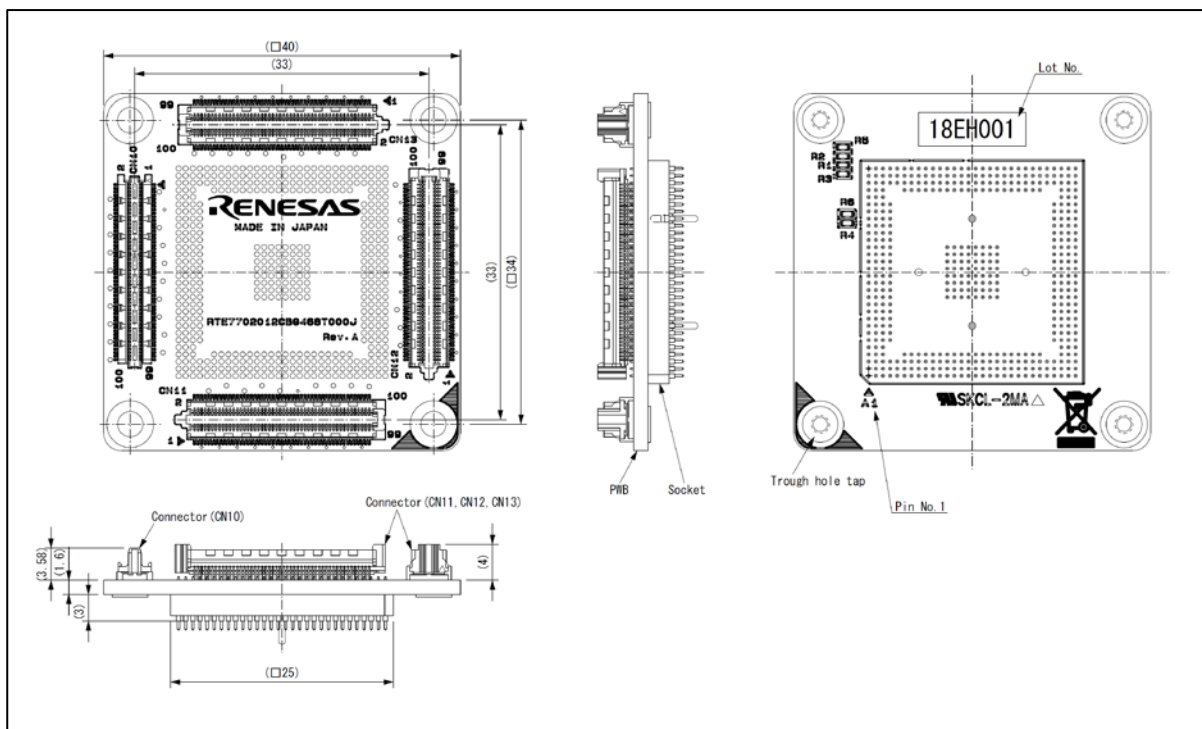

Figure A-2 Dimensions of the RTE7702012CBG468T000J (468 pins)

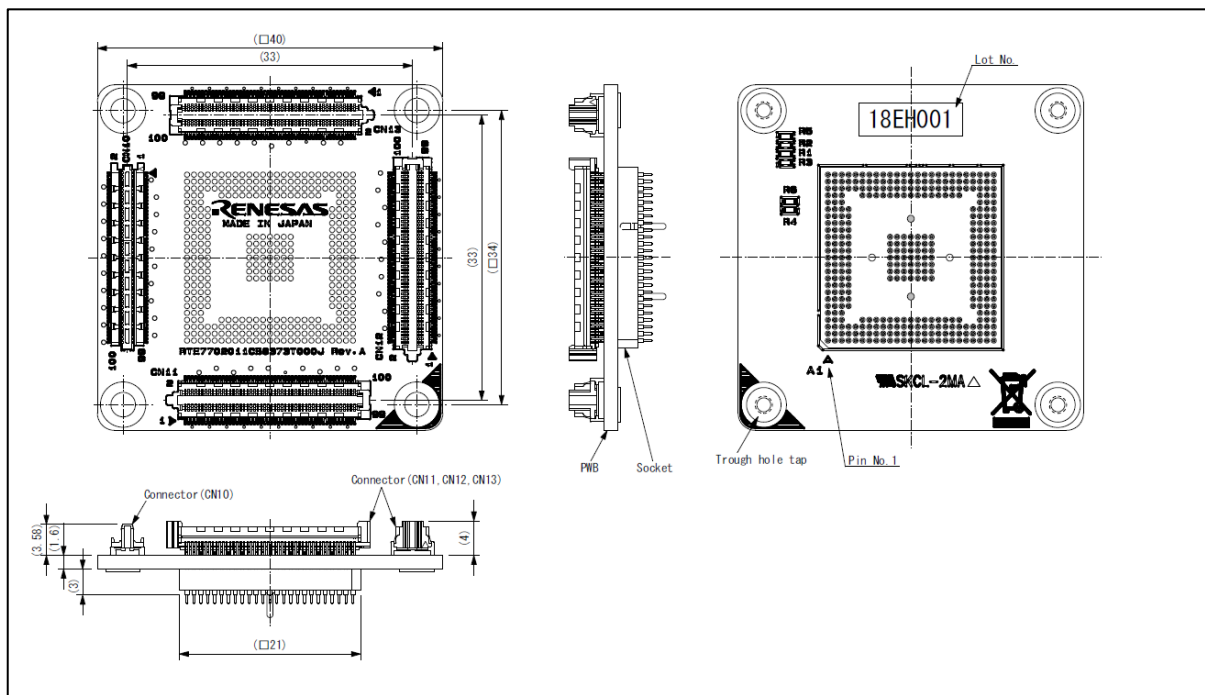

Figure A-3 Dimensions of the RTE7702011CBG373T000J (373 pins)

(6) Drawing of the assembly

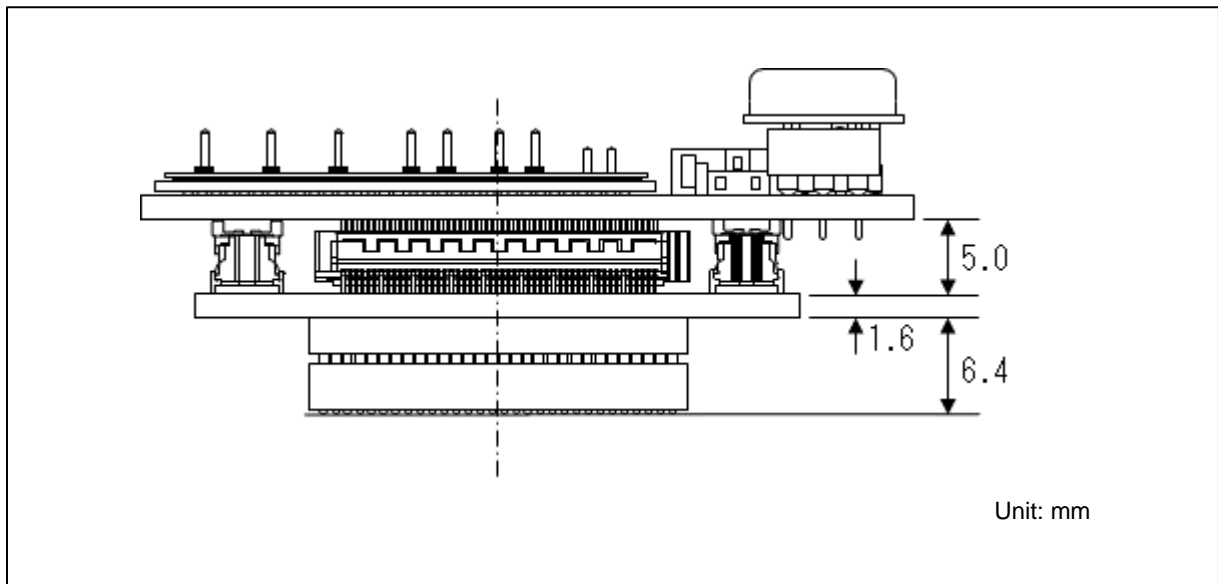

Figure A-4 Drawing of the Assembly for the RTE7702012CBG468T000J (468 pins)

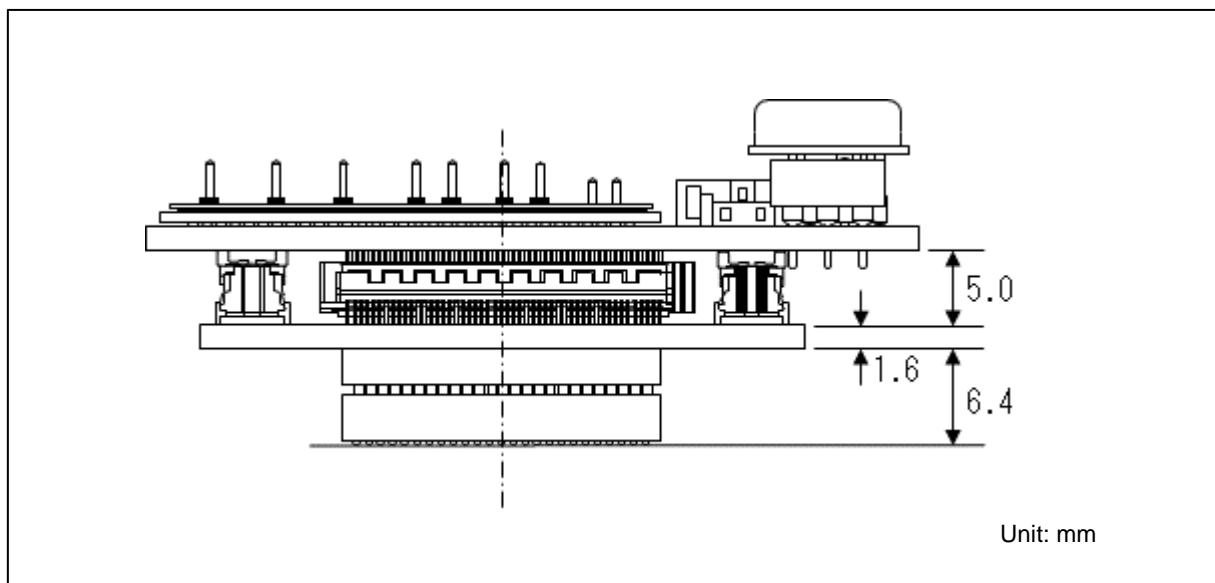

Figure A-5 Drawing of the Assembly for the RTE7702011CBG373T000J (373 pins)

(7) Characteristics of the target interface

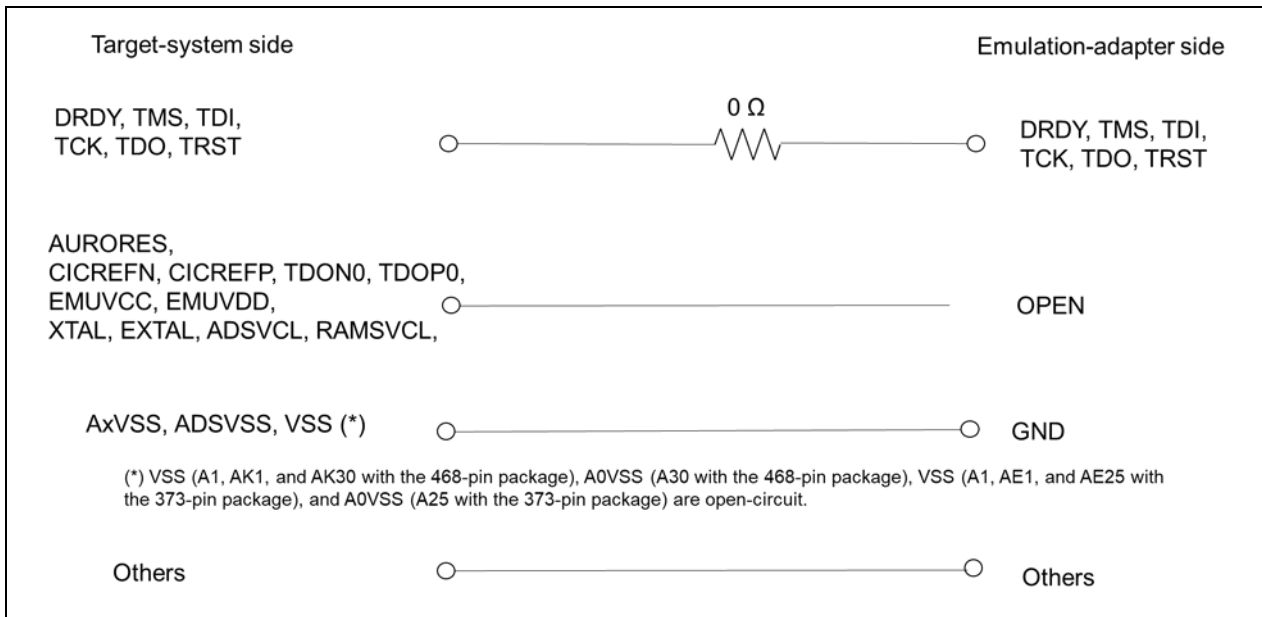

Figure A-6 Equivalent Circuit



**(8) Precautions and WEEE directive****CAUTION**

If the requirements shown in the "CAUTION" sentences are ignored, the equipment may cause personal injury or damage to the products.

**⚠ CAUTION**

## Cautions to be Taken for This Product:



- Inquiries regarding CSSOCKET used for adjusting the height of the assembly, please send an email to the address below.

Tokyo Eletech Corporation [http://www.tetc.co.jp/e\\_index.htm](http://www.tetc.co.jp/e_index.htm)

**IMPORTANT**

## Note on This Product:

- The exchange adapter is not repairable.
- Inquiries regarding the purchase of BSSOCKET, CSSOCKET, and LSPACK, please send an email to the address below.

Tokyo Eletech Corporation [http://www.tetc.co.jp/e\\_index.htm](http://www.tetc.co.jp/e_index.htm)

## Disposal Instruction (This is only valid in the European Union.):



The WEEE (Waste Electrical and Electronic Equipment) regulations put responsibilities on producers for the collection and recycling or disposal of electrical and electronic waste. Return of WEEE under these regulations is applicable in the European Union only. This equipment (including all accessories) is not intended for household use. After use the equipment cannot be disposed of as household waste, and the WEEE must be treated, recycled and disposed of in an environmentally sound manner.

Renesas Electronics Europe GmbH can take back end of life equipment, register for this service at "<http://www.renesas.eu/weee>".

All trademarks and registered trademarks are the property of their respective owners.

Revision History	Emulation Adapter for the RH850/E2UH and E2H Groups User's Manual
------------------	--

Rev.	Date	Description	
		Page	Summary
1.00	Dec 01, 2018	—	First Edition issued
1.10	Nov 01, 2019	11,15	The type name of debug chip was changed from R7F702Z10ADBG to R7F702Z10AADBG.

---

Emulation Adapter for the RH850/E2UH and E2H Groups  
User's Manual

Publication Date: Rev.1.00 Dec 01, 2018  
Rev.1.10 Nov 01, 2019

Published by:           Renesas Electronics Corporation



Renesas Electronics Corporation

<http://www.renesas.com>

**SALES OFFICES**

Refer to "<http://www.renesas.com/>" for the latest and detailed information.

**Renesas Electronics Corporation**  
TOYOSU FORESIA, 3-2-24 Toyosu, Koto-ku, Tokyo 135-0061, Japan

**Renesas Electronics America Inc.**  
1001 Murphy Ranch Road, Milpitas, CA 95035, U.S.A.  
Tel: +1-408-432-8888, Fax: +1-408-434-5351

**Renesas Electronics Canada Limited**  
9251 Yonge Street, Suite 8309 Richmond Hill, Ontario Canada L4C 9T3  
Tel: +1-905-237-2004

**Renesas Electronics Europe Limited**  
Dukes Meadow, Millboard Road, Bourne End, Buckinghamshire, SL8 5FH, U.K  
Tel: +44-1628-651-700

**Renesas Electronics Europe GmbH**  
Arcadiastrasse 10, 40472 Düsseldorf, Germany  
Tel: +49-211-6503-0, Fax: +49-211-6503-1327

**Renesas Electronics (China) Co., Ltd.**  
Room 1709 Quantum Plaza, No.27 ZhichunLu, Haidian District, Beijing, 100191 P. R. China  
Tel: +86-10-8235-1155, Fax: +86-10-8235-7679

**Renesas Electronics (Shanghai) Co., Ltd.**  
Unit 301, Tower A, Central Towers, 555 Langao Road, Putuo District, Shanghai, 200333 P. R. China  
Tel: +86-21-2226-0888, Fax: +86-21-2226-0999

**Renesas Electronics Hong Kong Limited**  
Unit 1601-1611, 16/F., Tower 2, Grand Century Place, 193 Prince Edward Road West, Mongkok, Kowloon, Hong Kong  
Tel: +852-2265-6688, Fax: +852 2886-9022

**Renesas Electronics Taiwan Co., Ltd.**  
13F, No. 363, Fu Shing North Road, Taipei 10543, Taiwan  
Tel: +886-2-8175-9600, Fax: +886 2-8175-9670

**Renesas Electronics Singapore Pte. Ltd.**  
80 Bendemeer Road, Unit #06-02 Hyflux Innovation Centre, Singapore 339949  
Tel: +65-6213-0200, Fax: +65-6213-0300

**Renesas Electronics Malaysia Sdn.Bhd.**  
Unit 1207, Block B, Menara Amcorp, Amcorp Trade Centre, No. 18, Jln Persiaran Barat, 46050 Petaling Jaya, Selangor Darul Ehsan, Malaysia  
Tel: +60-3-7955-9390, Fax: +60-3-7955-9510

**Renesas Electronics India Pvt. Ltd.**  
No.77C, 100 Feet Road, HAL 2nd Stage, Indiranagar, Bangalore 560 038, India  
Tel: +91-80-67208700, Fax: +91-80-67208777

**Renesas Electronics Korea Co., Ltd.**  
17F, KAMCO Yangjae Tower, 262, Gangnam-daero, Gangnam-gu, Seoul, 06265 Korea  
Tel: +82-2-558-3737, Fax: +82-2-558-5338

# Emulation Adapter for the RH850/E2UH and E2H Groups

RTE7702012EAB00000J

User's Manual



Renesas Electronics Corporation

R20UT4460EJ0110