

ISL6726EVAL1Z

Current Mode Active Clamp Forward with SR for Medium Power Applications

AN1628
Rev 1.00
December 20, 2012

Description

The ISL6726EVAL1Z board is a 48V input to 5V output DC/DC converter that can output current up to 40A. This application note includes the test setup, test report, schematics, layout, and bill of materials (BOM).

The ISL6726EVAL1Z board uses the ISL6726, an advanced current mode PWM controller, to implement control of an Active Clamp Forward. The circuit operates at fixed frequency with peak current control mode. To get high efficiency, the converter adopts a synchronous rectifier to replace the diode rectifier.

Figures 1 and 2 show top and bottom views of the ISL6726EVAL1Z board. Actual size is 40x60x16mm.

Applications

- Telecom and Datacom Power
- AC/DC Power Supplies
- DC Transformers
- Bus Converters

Key Features

- Precision Duty Cycle and Dead-Time Control
- 180 μ A Start-up Current
- Adjustable Average and Peak Current Limit Protection
- Programmable Oscillator Frequency Up to 1MHz
- Bi-directional Synchronization with 180° Out-of-Phase
- Adjustable Soft-Start, Soft-Stop
- Selectable Minimum Duty Cycle Clamp for Synchronous Rectifier Applications
- Programmable Slope Compensation
- Supports N-Channel and P-Channel Active Clamp FETs
- Programmable Undervoltage Lock-out
- Input Voltage Dependent Duty Cycle Clamp
- 35ns Control to Output Propagation Delay
- Internal Over-Temperature Protection



FIGURE 1. TOP VIEW OF ISL6726EVAL1Z
(ACTUAL SIZE: 40x60x16mm)

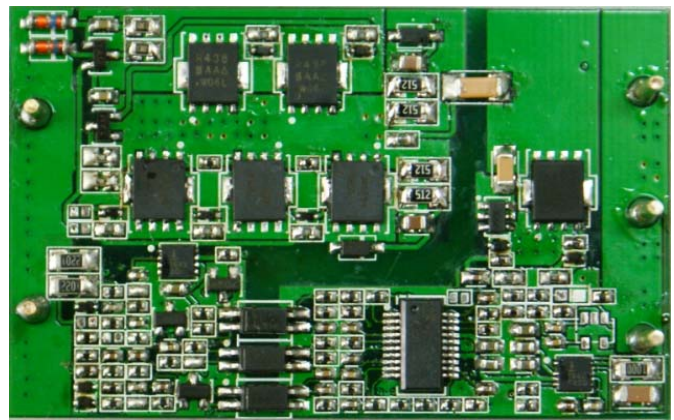

FIGURE 2. BOTTOM VIEW OF ISL6726EVAL1Z
(ACTUAL SIZE: 40x60x16mm)

Design Specifications

Design specifications for the ISL6726EVAL1Z board are shown in Table 1.

TABLE 1. ISL6726EVAL1Z DESIGN SPECIFICATIONS

CHARACTERISTICS	CONDITIONS	MIN	TYP	MAX	UNITS
Frequency			220		kHz
Input Voltage		36		75	V
Output Voltage			5		V
Output Current		0		40	A
Efficiency			92		%
Load Regulation	$V_{IN} = 48V$		70		mV
Line Regulation	$I_O = 40A$		30		mV
Ripple and Noise	$I_O = 40A$		200		mV
Start-up Time	$I_O = 40A$		40		ms
Dynamic (without additional capacitor)	25% - 50% - 25% 50% - 75% - 50% 0.2A/ μ s		\pm 650		mV
OCP	Value	$V_{IN} = 48V$	44		A
	Hiccup delay time		1600		ms
OTP	Value	$V_{IN} = 48V$	105		$^{\circ}C$
	Hysteresis		20		$^{\circ}C$
Input UVP	Value	$I_O = 40A$	31		V
	Hysteresis		2		V
Output OVP	Value	$I_O = 40A$	6.1		V
EN	Negative logical signal	-0.2	0	0.2	V
Output Capacitor	$I_O = 40A$	0		2200	μ F

Test Setup

Table 2 gives the pin descriptions for the ISL6726EVAL1Z board, and Figure 3 shows the pin diagram.

TABLE 2. ISL6726EVAL1Z PIN DESCRIPTIONS

PIN	SYMBOL	DESCRIPTION
P1	VIN	Input Voltage Positive
P2	VIN-RTN	Input Voltage Negative
P3	EN	Enable (Negative Logical)
P4	VOUT-RTN	Output Voltage Negative
P5	VOUT	Output Voltage Positive

NOTES:

1. Enable Logic: EN pin must be connected to VIN-RTN before input power is applied.
2. Input Voltage: Input voltage is 36V to 75V. Voltage applied to converter cannot be higher than 75V.
3. Output Load: Load must be connected to VOUT and VOUT-RTN pins. Maximum output current is 40A.
4. Cooling: Converter needs forced air cooling; recommended air speed is 3m/s at full load.

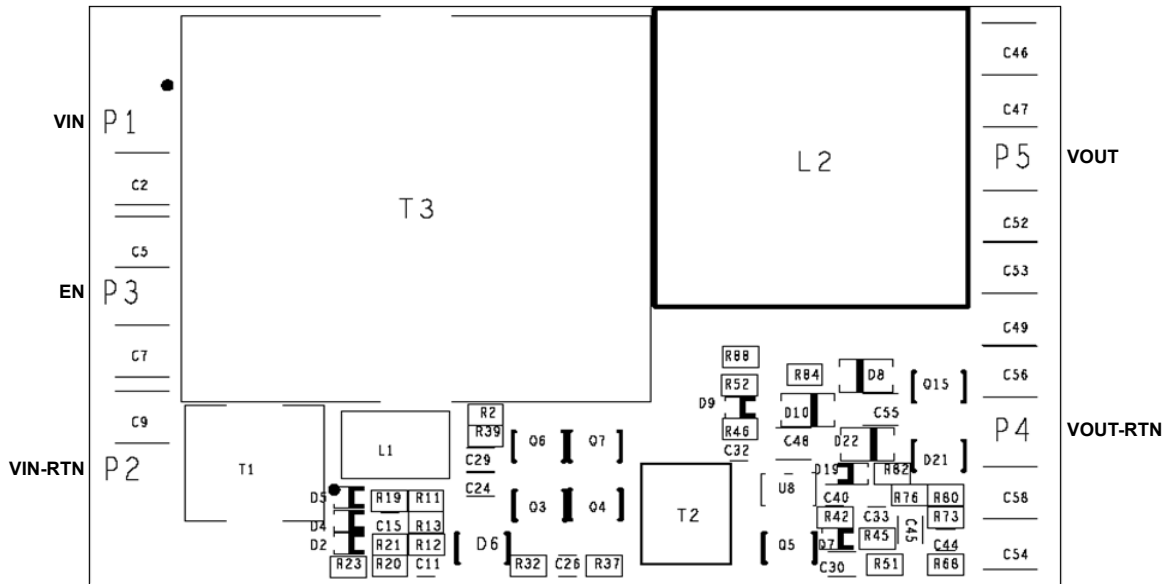
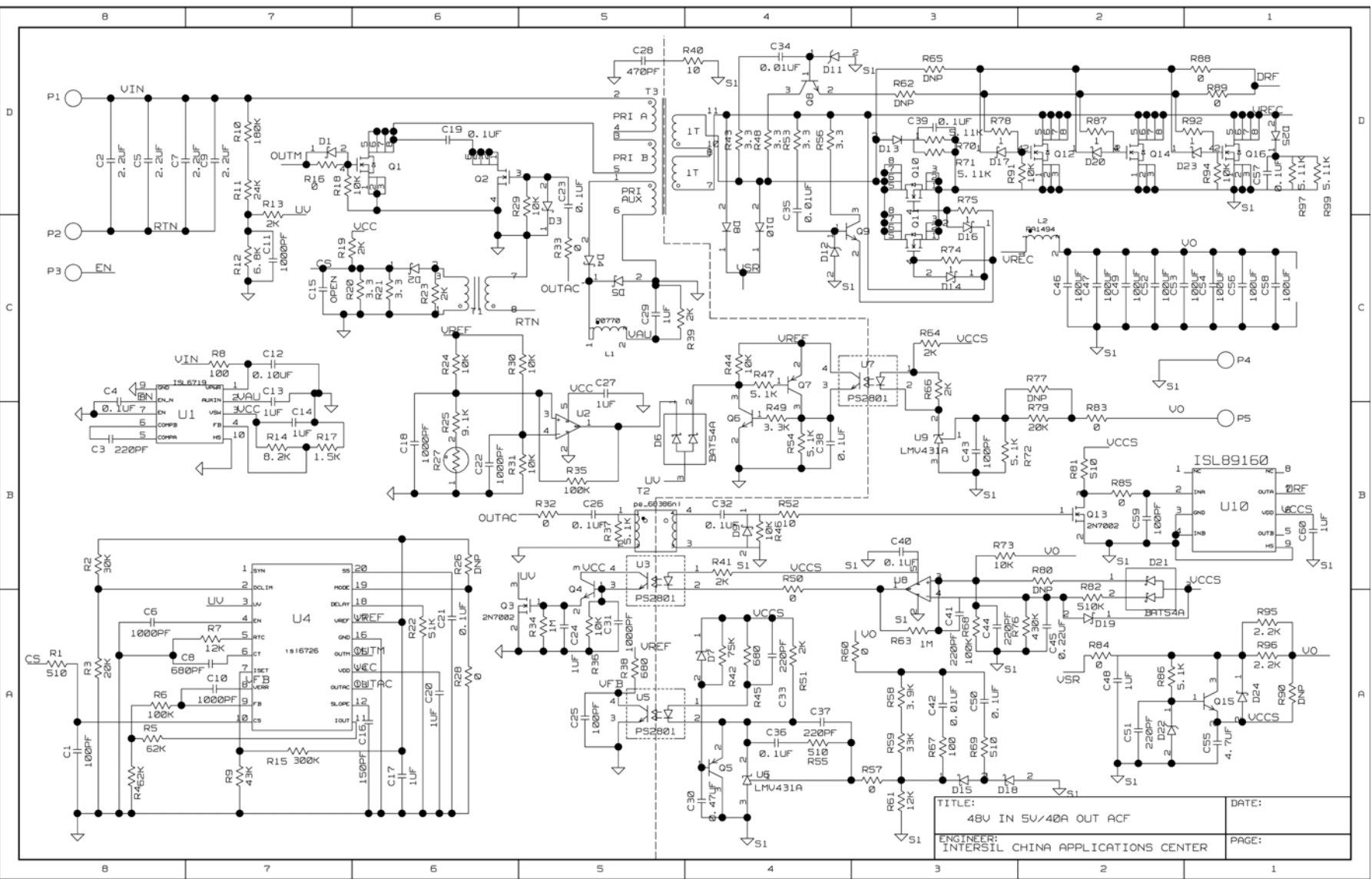

FIGURE 3. ISL6726EVAL1Z PIN DIAGRAM

ISL6726EVAL1Z Schematic



Silkscreens

Figures 4 and 5 show silkscreen images of the ISL6726EVAL1Z board top and bottom views.

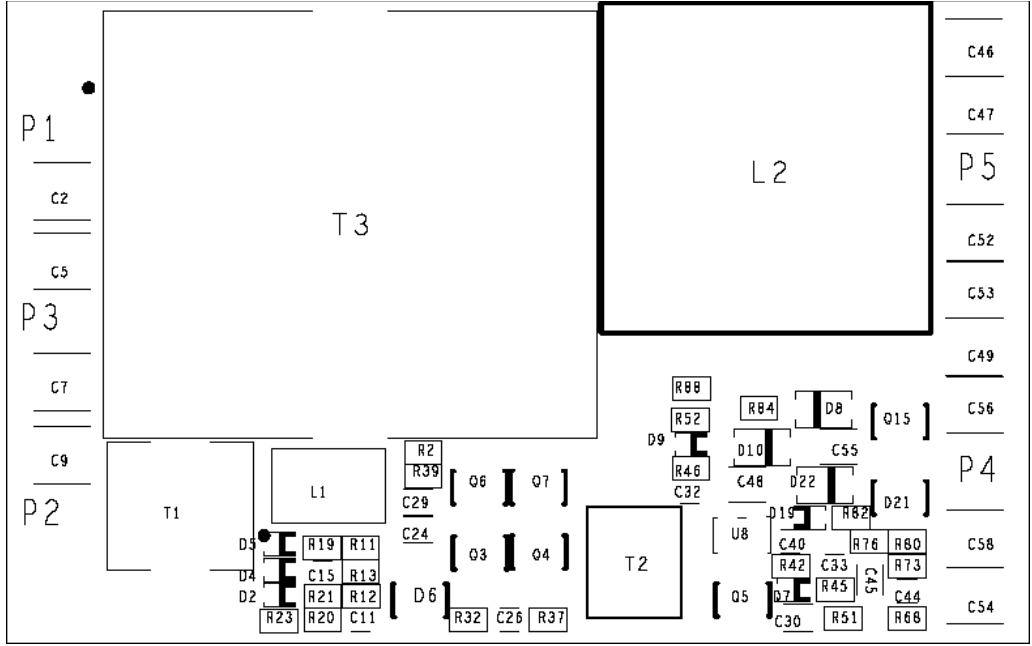

FIGURE 4. ISL6726EVAL1Z TOP VIEW

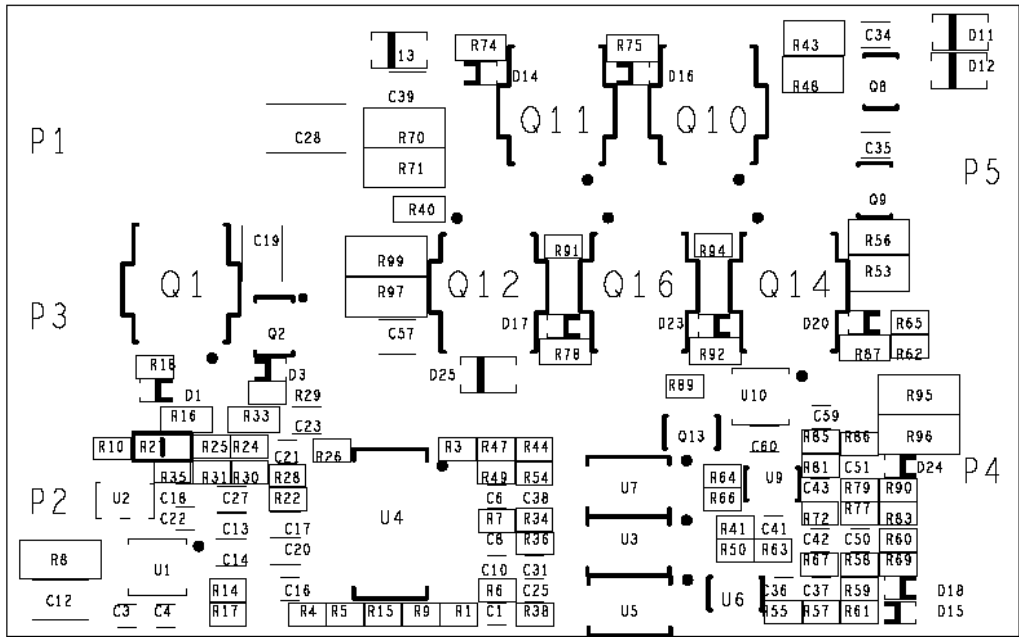

FIGURE 5. ISL6726EVAL1Z BOTTOM VIEW

Bill of Materials

PART NUMBER	REF DES	QTY	VALUE	MANUFACTURER
LMV431	U6, U9	2		NATIONAL SEMI
2N7002	Q3, Q13	2		ZETEX
BAT54A	D6, D21	2		ZETEX
BC857	Q7, Q5	2	PNP	Philips
BC847	Q4, Q6, Q8, Q9, Q15	5	NPN	Philips
P0770.224NL	L1	1	220μH	PULSE
PA1294.910NL	L2	1	0.91μH	PULSE
ISL6719	U1	1		INTERSIL
ISL6726	U4	1		INTERSIL
12103C225KAT2A	C2, C5, C7, C9	4	2.2μF/100V	AVX
1808N471K202N	C28	1	470pF/2kV	NOVACAP
1N4148W-V	D8, D10, D13, D25	4		VISHAY
76C100P	P1-P5	5		GENERIC
BZT52C7V5	D22	1		DIODES
BZT52C18	D11,D12,	2		DIODES
C1005C0G1H221J	C3, C37, C41, C44, C51	6	220pF	TDK
C1608X7R1C105K	C13, C14, C27, C29, C60, C17, C20, C24	8	1μF	TDK
C1608X7R1C474K	C30	1	0.47μF	TDK
C3216X7R2E104K	C19	1	0.1μF	TDK
BAS516	D1-D5, D7, D9, D14-D20, D23, D24	16		DIODES
EL5111	U2, U8	2		INTERSIL
ERTJ1VR682J	R27	1	6.8k	PANASONIC
GRM31CR72A104KW03L	C12	1	0.10UF	MuRata
H1044-00101-50V5	C1, C25, C43, C59	4	100pF	GENERIC
H1044-00102-50V10	C6, C10, C11, C18, C22, C31	6	1000pF	GENERIC
H1044-00103-16V10	C42	1	0.01μF	GENERIC
H1044-00104-16V10	C4, C21, C26, C32, C36, C38, C40, C50, C23	9	0.1μF	GENERIC
H1044-00151-50V5	C16	1	150pF	GENERIC
H1044-00681-50V10	C8	1	680pF	GENERIC
H1044-OPEN	C15, C33	2	OPEN	GENERIC
H1045-00103-50V10	C34, C35	2	0.01μF	GENERIC
H1045-00224-16V10	C45	1	0.22μF	GENERIC
H1046-00104-100V10	C39, C57	2	0.1μF	GENERIC
H1046-00105-50V8020	C48	1	1μF	GENERIC
H1046-00475-10V20	C55	1	4.7μF	GENERIC
H1082-00107-6R3V20	C46, C47, C49, C52-C54, C56, C58	8	100μF	GENERIC
H2510-003R3-1/16W5	R20, R21, R52	2	3.3	GENERIC
H2510-00R00-1/16W	R28, R32, R50, R57, R60, R83-R85, R88, R89	10	0	GENERIC
H2510-01000-1/16W1	R67	1	100	GENERIC

Bill of Materials (Continued)

PART NUMBER	REF DES	QTY	VALUE	MANUFACTURER
H2510-01002-1/16W5	R18, R24, R29-R31, R36, R44, R46, R73, R91, R94	11	10k	GENERIC
H2510-01003-1/16W1	R6, R35, R68	3	100k	GENERIC
H2510-01004-1/16W1	R34, R63	2	1M	GENERIC
H2510-01202-1/16W1	R7, R61	2	12k	GENERIC
H2510-01501-1/16W1	R17	1	1.5k	GENERIC
H2510-01803-1/16W5	R10	1	180k	GENERIC
H2510-02001-1/16W5	R13, R19, R23, R39, R41, R51, R64, R66	8	2k	GENERIC
H2510-02002-1/16W5	R3, R79	2	20k	GENERIC
H2510-02402-1/16W5	R11	1	24k	GENERIC
H2510-03002-1/16W1	R2	1	30k	GENERIC
H2510-03003-1/16W5	R15	1	300k	GENERIC
H2510-03301-1/16W5	R49	1	3.3k	GENERIC
H2510-03302-1/16W1	R59	1	33k	GENERIC
H2510-03901-1/16W5	R58	1	3.9k	GENERIC
H2510-04302-1/16W1	R9	1	43k	GENERIC
H2510-04303-1/16W1	R76	1	430k	GENERIC
H2510-05100-1/16W1	R1, R55, R69, R81	4	510	GENERIC
H2510-05101-1/16W1	R37, R47, R54, R72, R86	5	5.1k	GENERIC
H2510-05102-1/16W5	R22	1	51k	GENERIC
H2510-05103-1/16W1	R82	1	510k	GENERIC
H2510-06202-1/16W1	R4, R5	2	62k	GENERIC
H2510-06800-1/16W5	R38, R45	2	680	GENERIC
H2510-06801-1/16W5	R12	1	6.8k	GENERIC
H2510-07502-1/16W5	R42	1	75k	GENERIC
H2510-08201-1/16W1	R14	1	8.2k	GENERIC
H2510-09101-1/16W1	R25	1	9.1k	GENERIC
H2510-DNP-DNP-1	R26, R62, R65, R77, R80, R90	6	DNP	GENERIC
H2511-00010-1/10W1	R74, R75, R78, R87, R92	5	1	GENERIC
H2511-00100-1/16W1	R40	1	10	GENERIC
H2511-00R00-1/16W1	R16, R33	2	1	GENERIC
H2512-003R3-1/10W1	R43, R48, R53, R56	4	3.6	GENERIC
H2513-01000-1/8W1	R8	1	100	GENERIC
H2513-02201-1/8W1	R95, R96	2	2.2k	GENERIC
H2513-05111-1/8W1	R70, R71, R97, R99	4	5.1k	GENERIC
PA2001NL	T2	1		PULSE
PG1019NL	T3	1		PULSE
PA1005.050	T1	1		PULSE
PS2801-1-A	U3, U5, U7	3		NEC
SI7738	Q1	1		VISHAY

Bill of Materials (Continued)

PART NUMBER	REF DES	QTY	VALUE	MANUFACTURER
SIR438DP	Q10, Q11	2		VISHAY
NTMFS4852N	Q12, Q14, Q16	3		ONSEMI
Si3437DV	Q2	1		VISHAY
ISL89160	U10	1		INTERSIL
TOTAL		218		

Test Results

Provided here are reports for the following tests of the ISL6726EVAL1Z board: efficiency, load regulation, start-up and shut-down, capacitive load start-up and shut-down (with 2200 μ F extra capacitor), protection function, ripple and noise, and dynamic response.

Efficiency Test

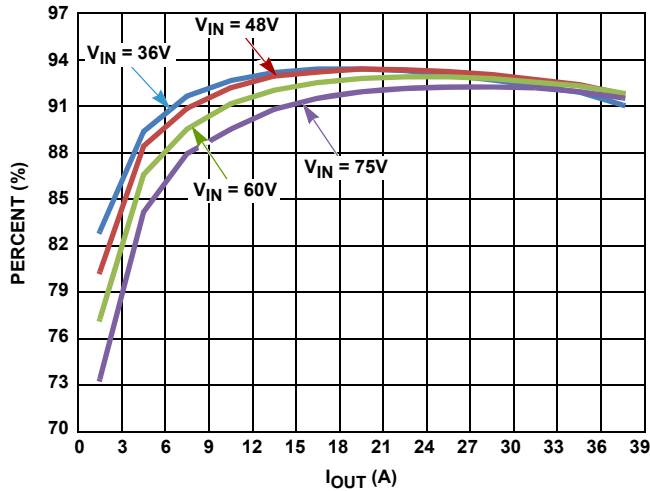

FIGURE 6. MAXIMUM EFFICIENCY ~93.4% @ 48V/21A, OR 36V/20A

TABLE 3. EFFICIENCY AT $V_{IN} = 36V$

V_{IN} (V)	I_{IN} (A)	PIN (W)	V_O (V)	I_O (A)	P_O (W)	η
36.070	0.505	18.2154	5.0243	3.006	15.1066	0.82993
36.054	0.941	33.9268	5.0235	6.036	30.3218	0.89374
36.038	1.374	49.5162	5.0270	9.029	45.3888	0.91664
36.025	1.806	65.0612	5.0243	12.000	60.2916	0.92669
36.012	2.234	80.4508	5.0140	14.952	74.9693	0.93187
35.998	2.681	96.5106	5.0110	17.990	90.1479	0.93407
35.984	3.312	112.702	5.007	21.025	105.272	0.93408
35.970	3.587	129.024	5.006	24.051	120.399	0.93315
35.955	4.046	145.474	5.005	27.039	135.330	0.93027
35.940	4.510	162.089	5.0013	30.048	150.279	0.92714
35.925	4.979	178.871	4.998	33.045	165.159	0.92334
35.909	5.455	195.884	4.996	36.036	180.036	0.91910
35.888	6.106	219.132	4.990	40.000	199.600	0.91087

TABLE 4. EFFICIENCY AT $V_{IN} = 48V$

V_{IN} (V)	I_{IN} (A)	PIN (W)	V_O (V)	I_O (A)	P_O (W)	η
48.070	0.392	18.8434	5.0362	3.0057	15.1373	0.80332
48.060	0.714	34.3148	5.0395	6.0210	30.3428	0.88425
48.048	1.039	49.9219	5.0320	9.0150	45.3635	0.90869
48.039	1.359	65.2850	5.0260	11.975	60.1864	0.92190
48.029	1.690	81.1690	5.0240	15.018	75.4504	0.92955
48.020	2.022	97.0964	5.0230	18.020	90.5145	0.93221
48.010	2.355	113.064	5.0190	21.041	105.605	0.93403
48.001	2.690	129.120	5.0134	24.046	120.552	0.93364
47.990	3.028	145.314	5.0083	27.054	135.495	0.93243
47.980	3.369	161.645	5.0036	30.058	150.398	0.93043
47.970	3.715	178.209	4.9985	33.060	165.250	0.92729
47.959	4.064	194.905	4.9930	36.067	180.083	0.92395
47.945	4.538	217.574	4.9850	40.065	199.724	0.91796

TABLE 5. EFFICIENCY AT $V_{IN} = 60V$

V_{IN} (V)	I_{IN} (A)	PIN (W)	V_O (V)	I_O (A)	P_O (W)	η
60.069	0.326	19.5825	5.0410	3.001	15.1321	0.77273
60.061	0.583	35.0156	5.0470	6.007	30.3199	0.86590
60.051	0.845	50.7431	5.0400	9.015	45.4356	0.89540
60.043	1.106	66.4076	5.0360	12.020	60.5327	0.91153
60.036	1.370	82.2493	5.0385	15.024	75.6984	0.92035
60.028	1.635	98.1458	5.0365	18.031	90.8131	0.92529
60.021	1.901	114.100	5.0336	21.037	105.892	0.92806
60.013	2.169	130.168	5.0291	24.046	120.930	0.92903
60.006	2.438	146.295	5.0238	27.054	135.914	0.92904
59.997	2.709	162.532	5.0178	30.058	150.825	0.92797
59.989	2.983	178.947	5.0100	33.060	165.631	0.92558
59.981	3.259	195.478	5.0040	36.065	180.469	0.92322
59.970	3.635	217.991	4.9970	40.065	200.205	0.91841

TABLE 6. EFFICIENCY AT $V_{IN} = 75V$

V_{IN} (V)	I_{IN} (A)	P_{IN} (W)	V_O (V)	I_O (A)	P_O (W)	η
75.069	0.275	20.6440	5.0437	3.003	15.1498	0.73386
75.063	0.480	36.0302	5.0479	6.007	30.3253	0.84166
75.056	0.689	51.7136	5.0445	9.015	45.4762	0.87939
75.046	0.902	67.6915	5.0415	12.020	60.5988	0.89522
75.041	1.111	83.3706	5.0390	15.022	75.6959	0.90794
75.034	1.323	99.2700	5.0380	18.033	90.8503	0.91518
75.028	1.536	115.243	5.0360	21.041	105.962	0.91947
75.022	1.751	131.364	5.0330	24.052	121.054	0.92152
75.016	1.967	147.556	5.0310	27.052	136.099	0.92235
75.009	2.184	163.820	5.0280	30.058	151.132	0.92255
75.003	2.403	180.232	5.0259	33.061	166.161	0.92193
74.996	2.626	196.939	5.0210	36.065	181.082	0.91948
74.987	2.927	219.487	5.0150	40.061	200.906	0.91534

Load Regulation Test

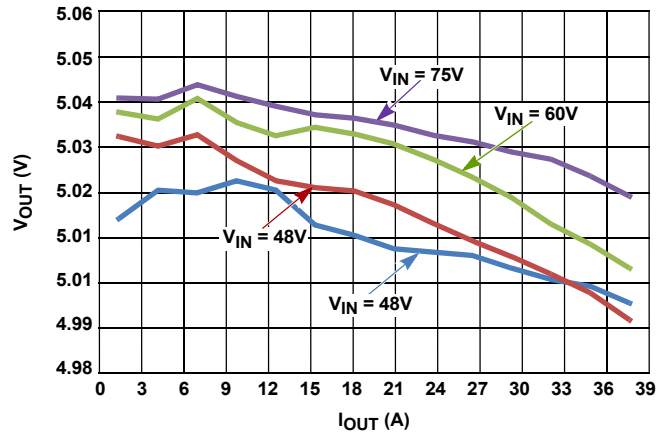

Start-Up and Shut-Down Test

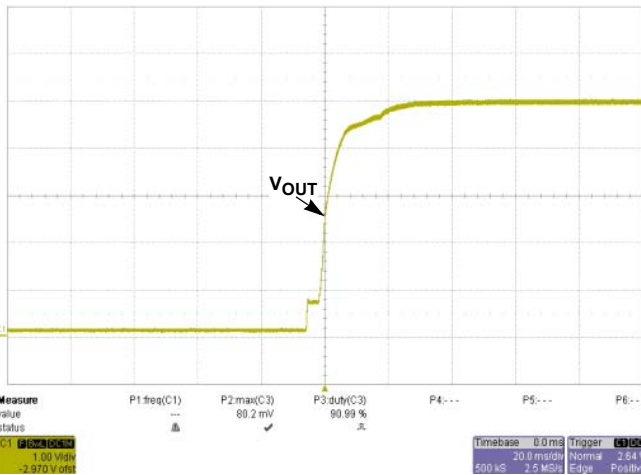

FIGURE 7. START-UP (30ms) AT $V_{IN} = 36V$ @ $I_O = 0A$

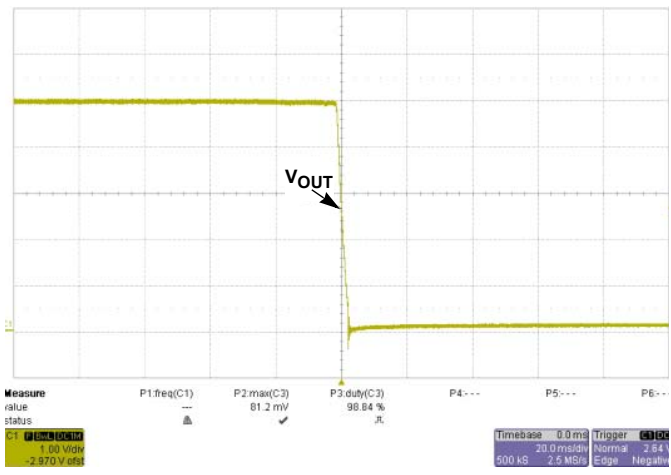

FIGURE 8. SHUT-DOWN AT $V_{IN} = 36V$ @ $I_O = 0A$

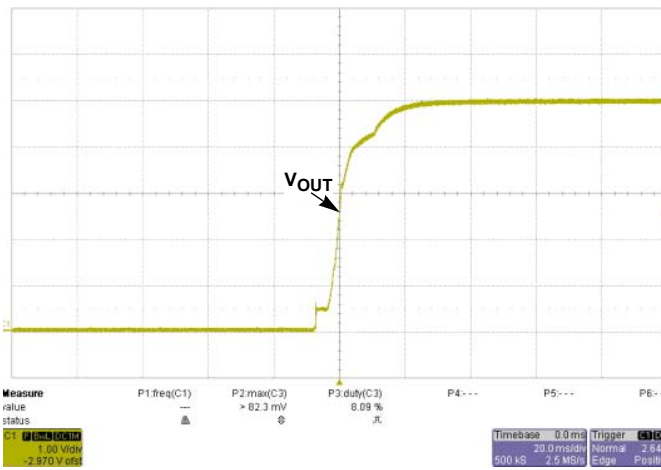

FIGURE 9. START-UP (30ms) AT $V_{IN} = 36V$ @ $I_O = 40A$

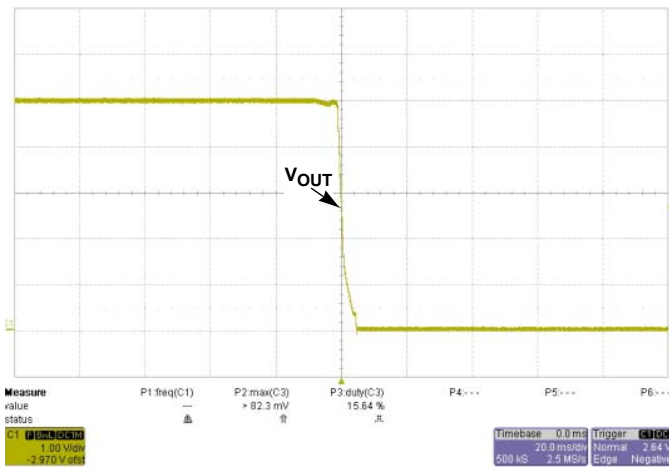

FIGURE 10. SHUT-DOWN AT $V_{IN} = 36V$ @ $I_O = 40A$

Start-Up and Shut-Down Test (Continued)

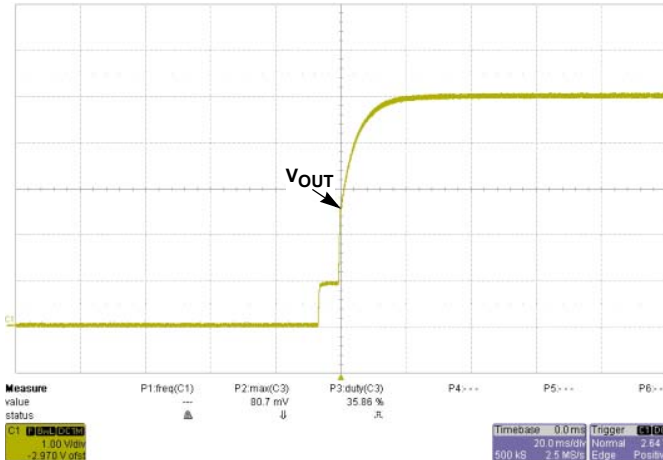

FIGURE 11. START-UP (30ms) AT $V_{IN} = 48V @ I_O = 0A$

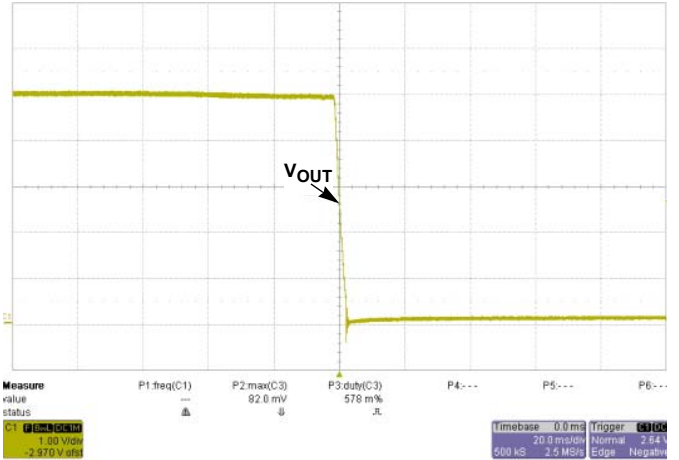

FIGURE 12. SHUT-DOWN AT $V_{IN} = 48V @ I_O = 0A$

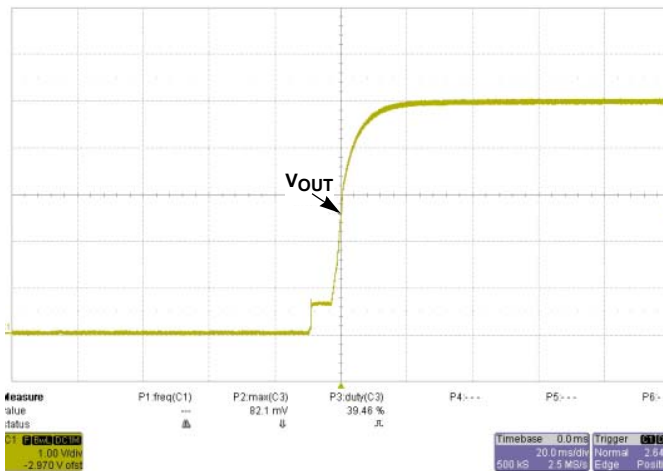

FIGURE 13. START-UP (30ms) AT $V_{IN} = 48V @ I_O = 40A$

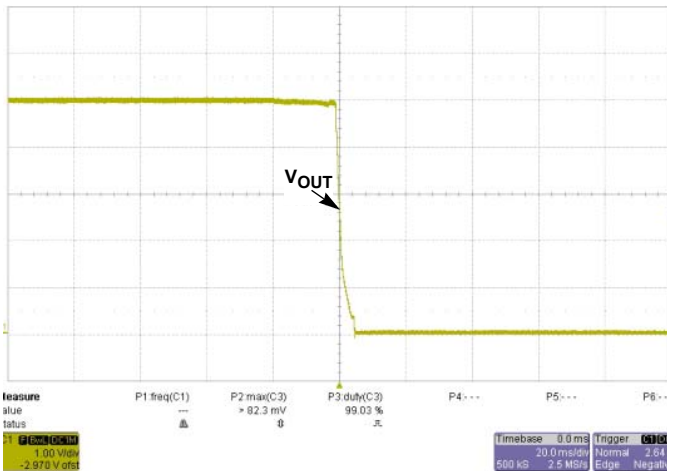

FIGURE 14. SHUT-DOWN AT $V_{IN} = 48V @ I_O = 40A$

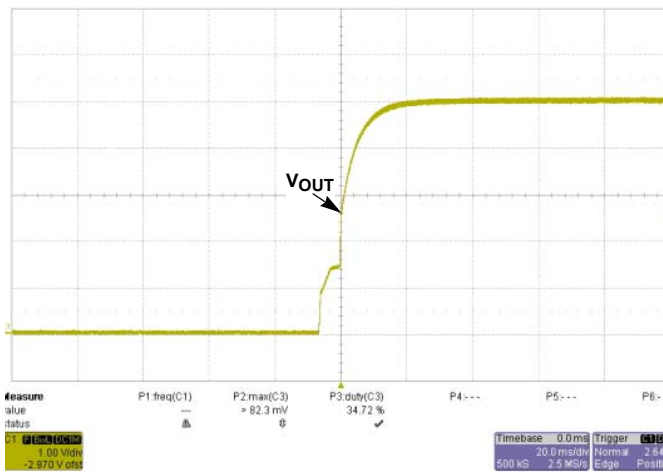

FIGURE 15. START-UP (30ms) AT $V_{IN} = 75V @ I_O = 0A$

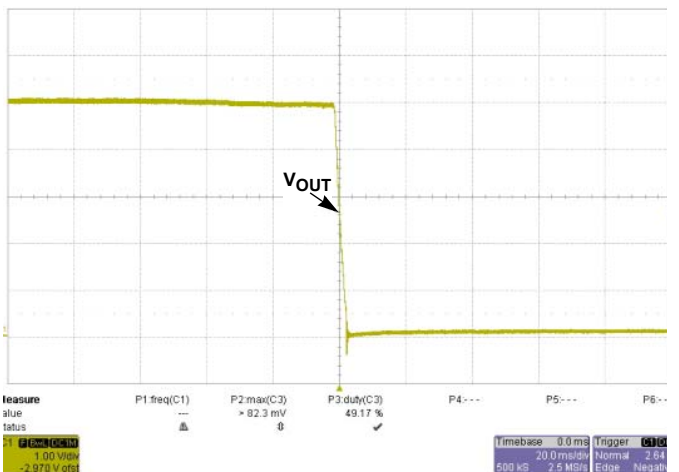

FIGURE 16. SHUT-DOWN AT $V_{IN} = 75V @ I_O = 0A$

Start-Up and Shut-Down Test (Continued)

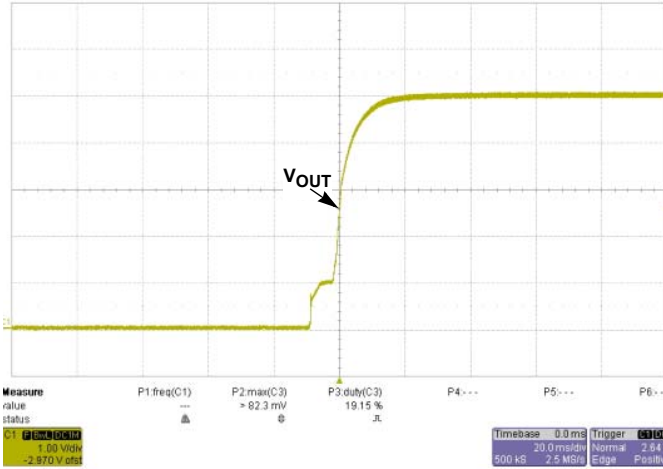

FIGURE 17. START-UP (30ms) AT $V_{IN} = 75V @ I_O = 40A$

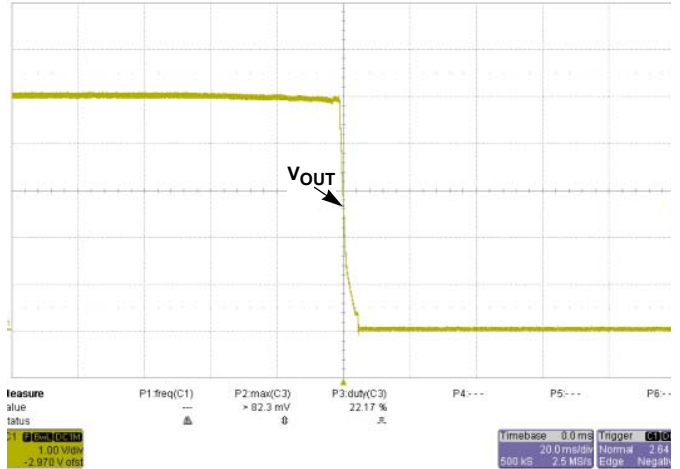

FIGURE 18. SHUT-DOWN AT $V_{IN} = 75V @ I_O = 40A$

Captive Load Start-Up and Shut-Down Test (with 2200µF Extra Capacitor)

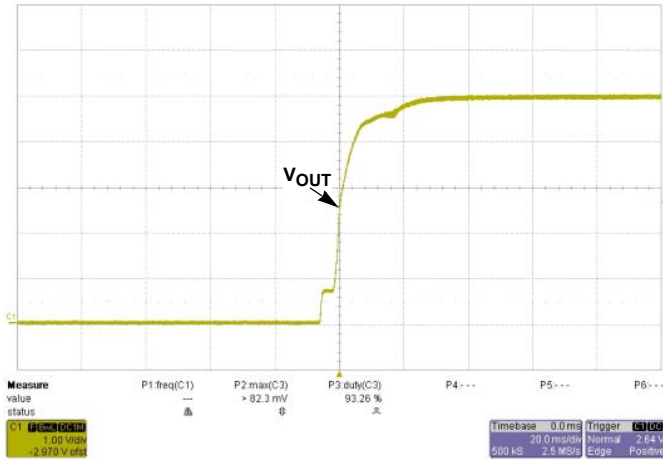

FIGURE 19. START-UP AT $V_{IN} = 36V @ I_O = 0A$

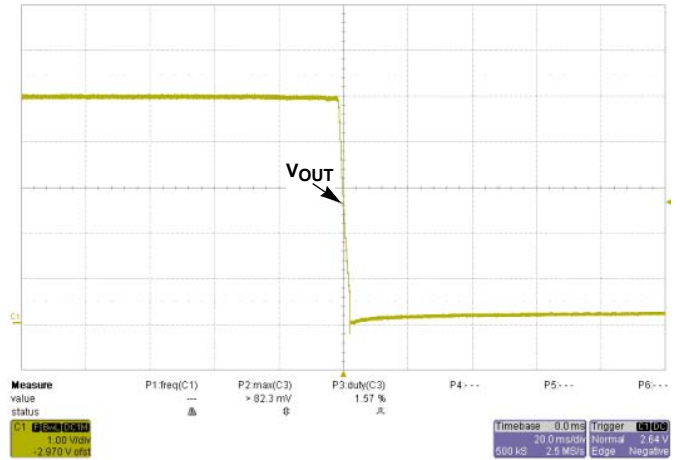

FIGURE 20. SHUT-DOWN AT $V_{IN} = 36V @ I_O = 0A$

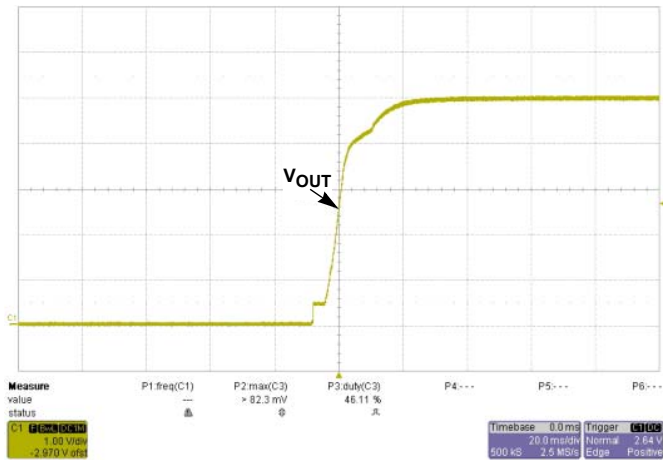

FIGURE 21. START-UP AT $V_{IN} = 36V @ I_O = 40A$

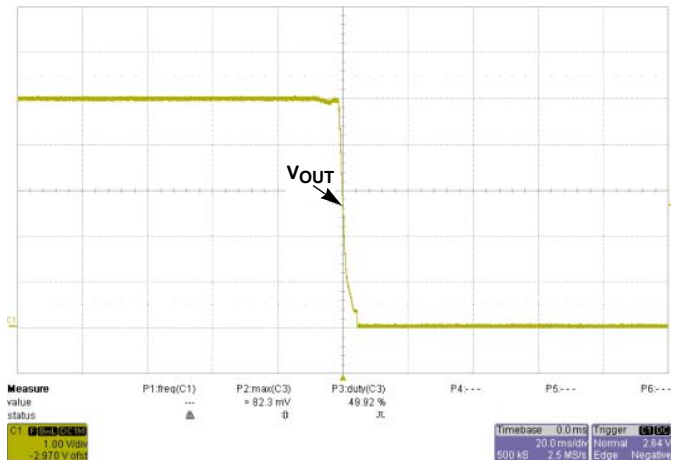

FIGURE 22. SHUT-DOWN AT $V_{IN} = 36V @ I_O = 40A$

Captive Load Start-Up and Shut-Down Test (with 2200µF Extra Capacitor) (Continued)

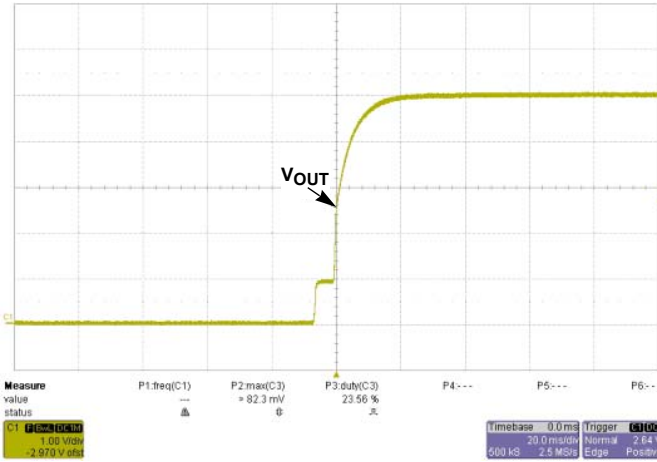

FIGURE 23. START-UP AT $V_{IN} = 48V @ I_O = 0A$

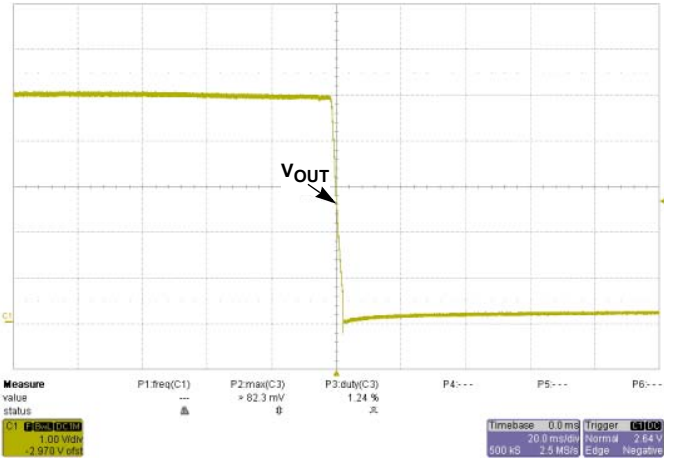

FIGURE 24. SHUT-DOWN AT $V_{IN} = 48V @ I_O = 0A$

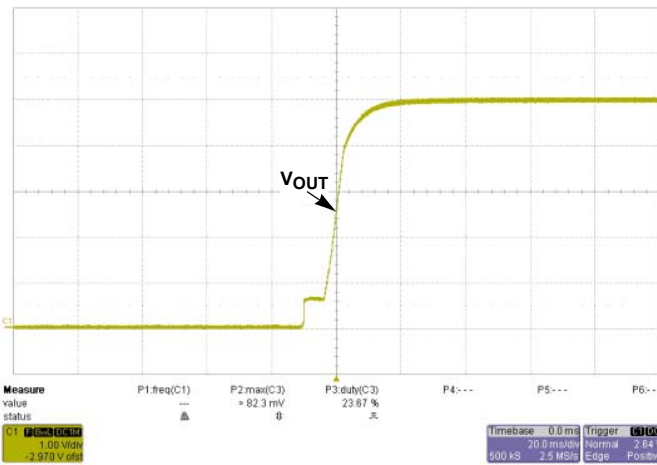

FIGURE 25. START-UP AT $V_{IN} = 48V @ I_O = 40A$

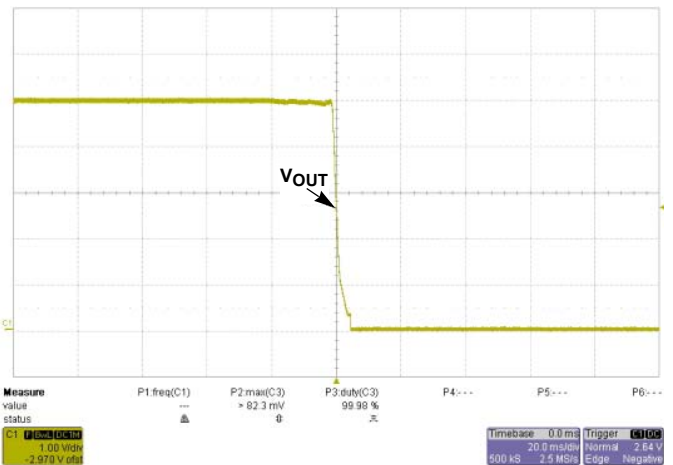

FIGURE 26. SHUT-DOWN AT $V_{IN} = 48V @ I_O = 40A$

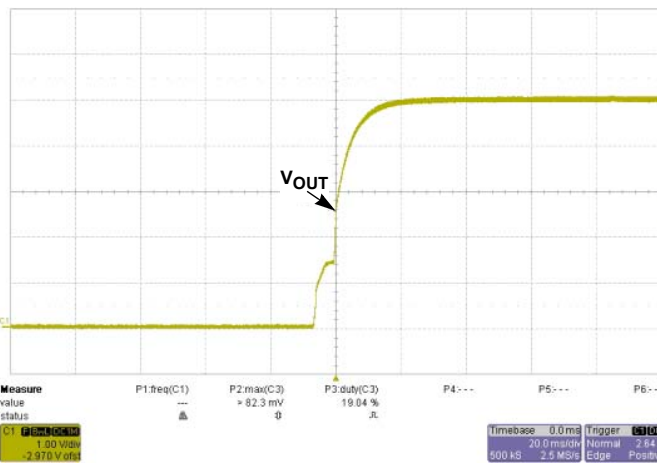

FIGURE 27. START-UP AT $V_{IN} = 75V @ I_O = 0A$

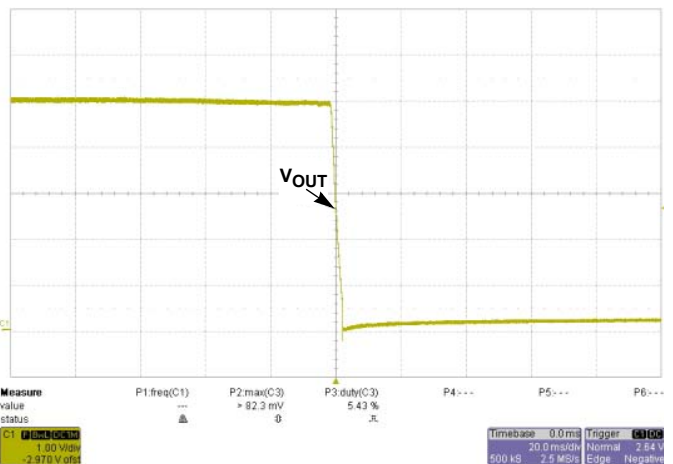

FIGURE 28. SHUT-DOWN AT $V_{IN} = 75V @ I_O = 0A$

Captive Load Start-Up and Shut-Down Test (with 2200µF Extra Capacitor) (Continued)

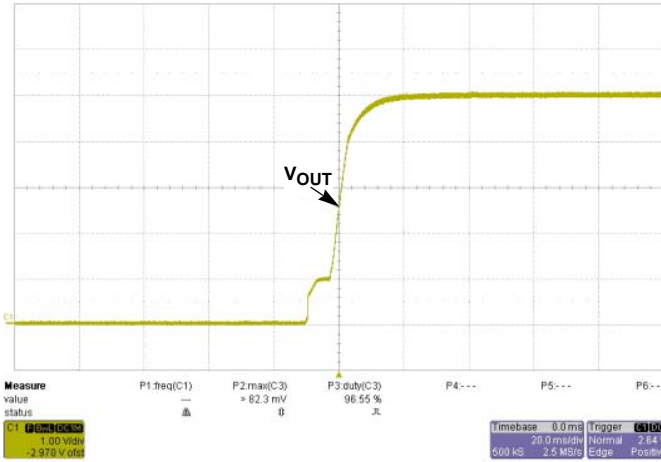

FIGURE 29. START-UP AT $V_{IN} = 75V @ I_O = 40A$

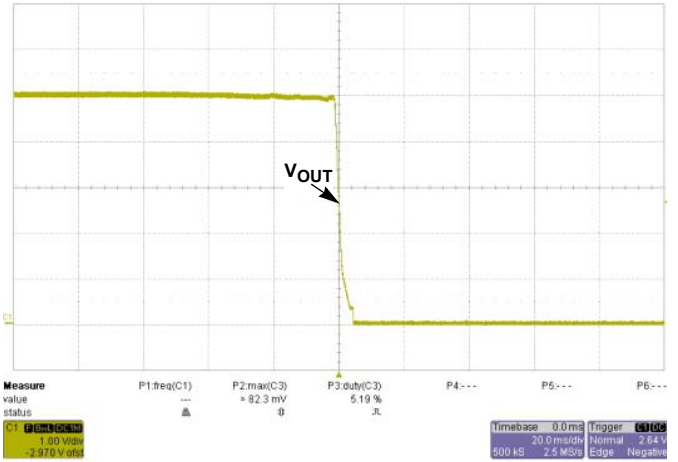

FIGURE 30. SHUT-DOWN AT $V_{IN} = 75V @ I_O = 40A$

Protection Function Test

INPUT UV PROTECTION

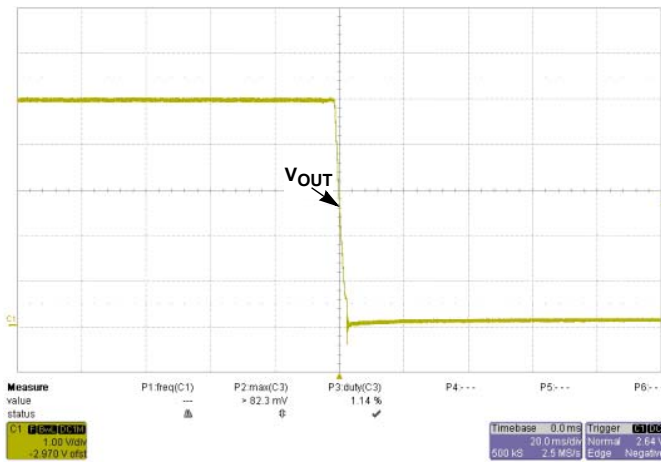

FIGURE 31. UVP @ 30.7V, $I_O = 0A$

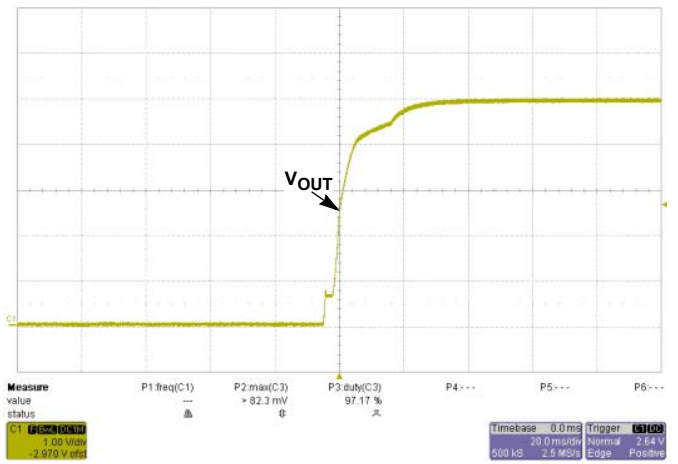

FIGURE 32. RECOVERY @ 33.1V, $I_O = 0A$

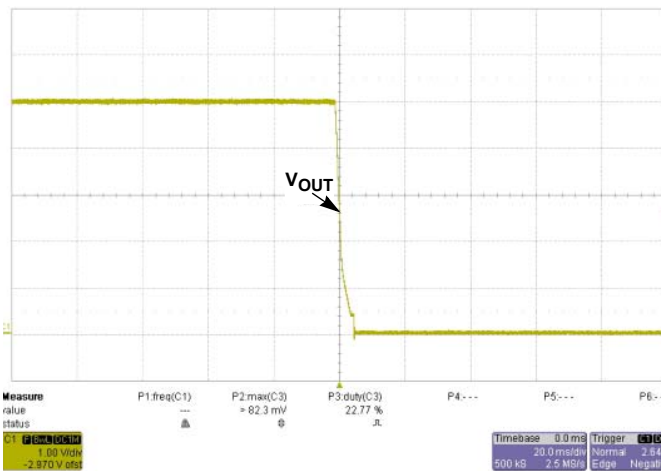

FIGURE 33. UVP @ 30.9V, $I_O = 40A$

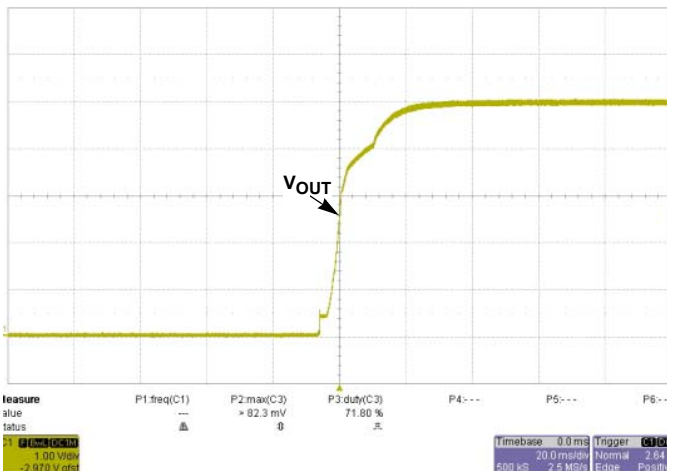

FIGURE 34. RECOVERY @ 33V, $I_O = 40A$

Protection Function Test (Continued)

OUTPUT OV PROTECTION POINT @ $V_O = 6.1V \pm 4.5\%$

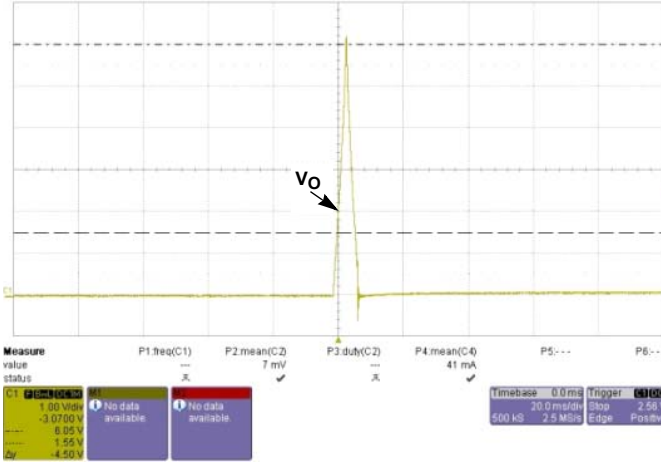

FIGURE 35. OVP @ $V_{IN} = 36V, I_O = 0A$

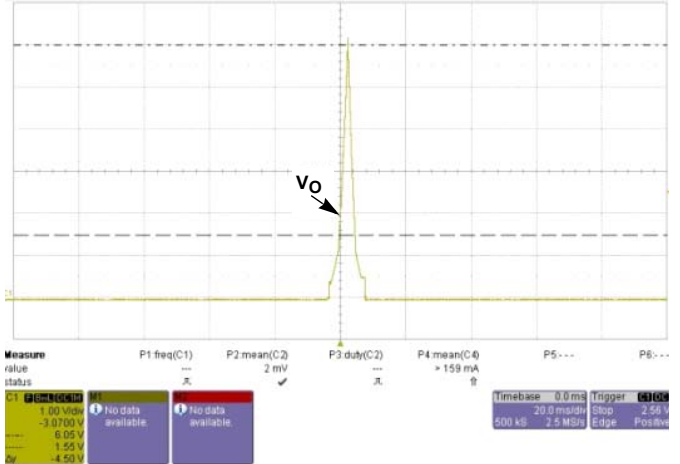

FIGURE 36. OVP @ $V_{IN} = 36V, I_O = 40A$

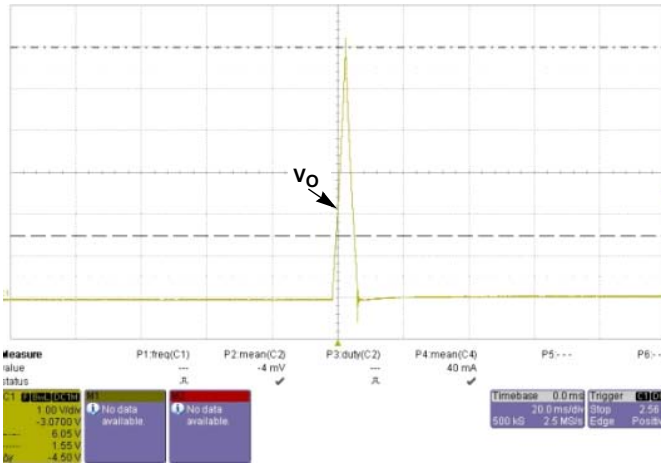

FIGURE 37. OVP @ $V_{IN} = 48V, I_O = 0A$

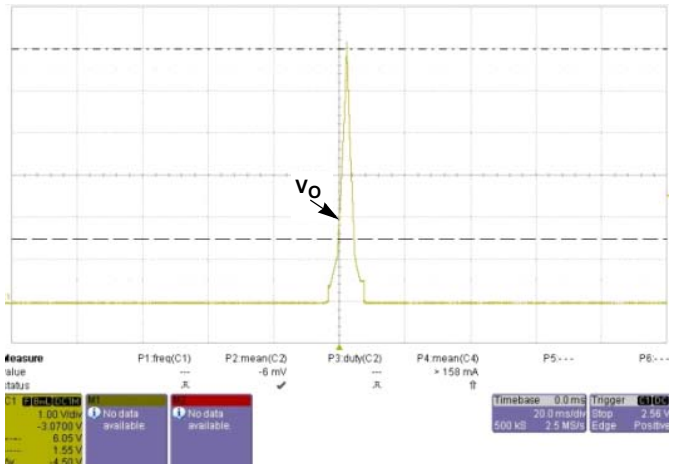

FIGURE 38. OVP @ $V_{IN} = 48V, I_O = 40A$

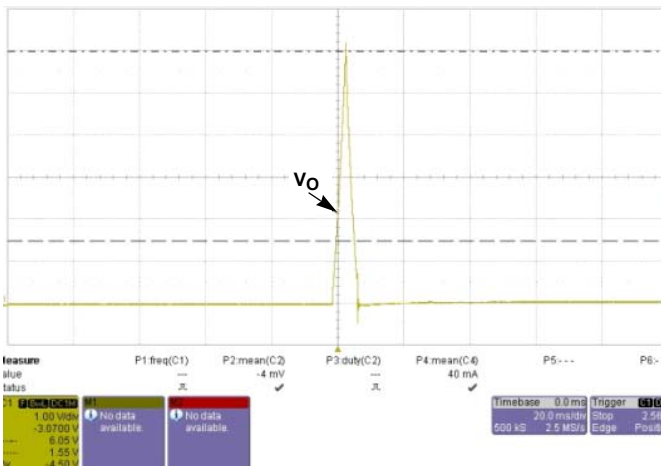

FIGURE 39. OVP @ $V_{IN} = 75V, I_O = 0A$

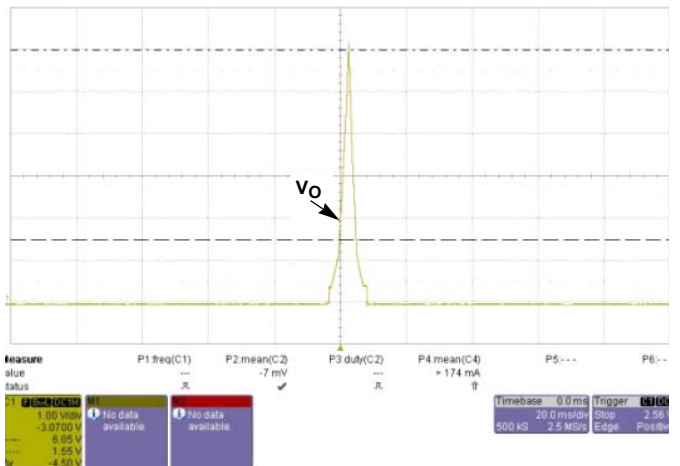

FIGURE 40. OVP @ $V_{IN} = 75V, I_O = 40A$

Protection Function Test (Continued)

OCP POINT @ $I_O = 44A \pm 5\%$

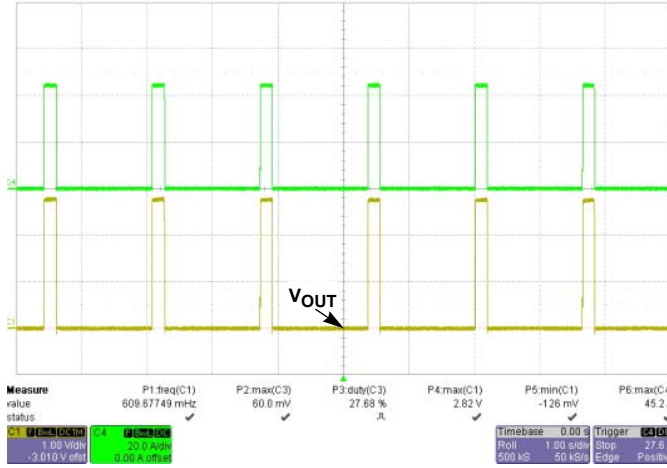

FIGURE 41. OCP = 45.2A @ $V_{IN} = 36V$ (LOAD MODE = CR; YELLOW = V_O , GREEN = I_O)

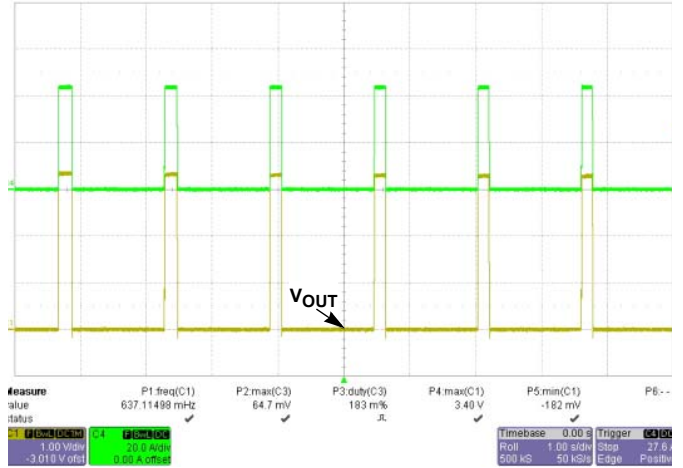

FIGURE 42. OCP = 44.6A @ $V_{IN} = 48V$ (LOAD MODE = CR; YELLOW = V_O , GREEN = I_O)

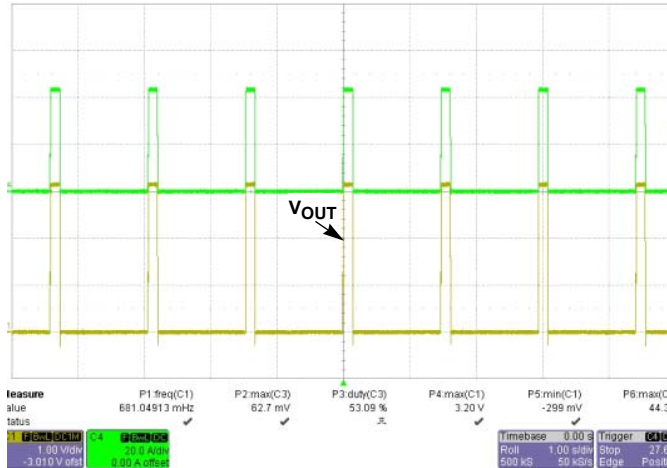

FIGURE 43. OCP = 44.3A @ $V_{IN} = 75V$ (LOAD MODE = CR; YELLOW = V_O , GREEN = I_O)

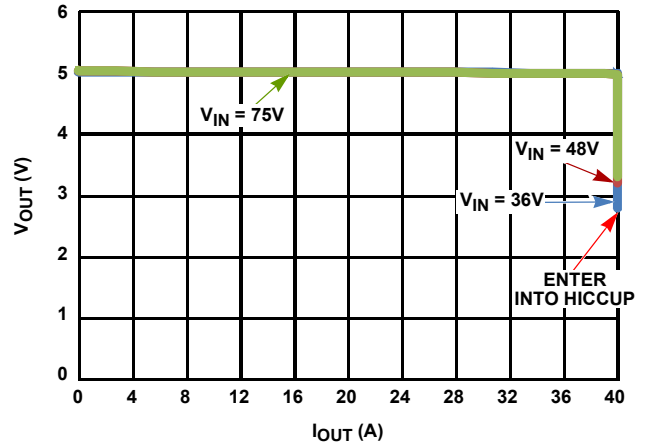

FIGURE 44. OCP CHARACTERISTICS

Protection Function Test (Continued)

SHORT TEST

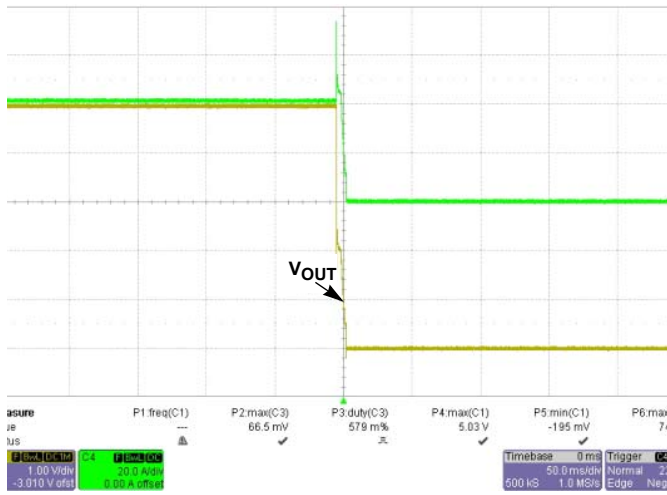

FIGURE 45. I_O OVERSHOOT, SHORT @ $V_{IN} = 36V$, $I_O = 40A$

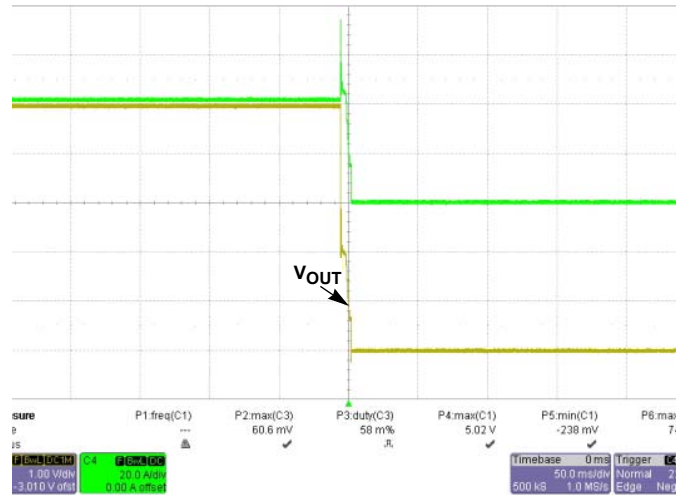

FIGURE 46. I_O OVERSHOOT, SHORT @ $V_{IN} = 48V$, $I_O = 40A$

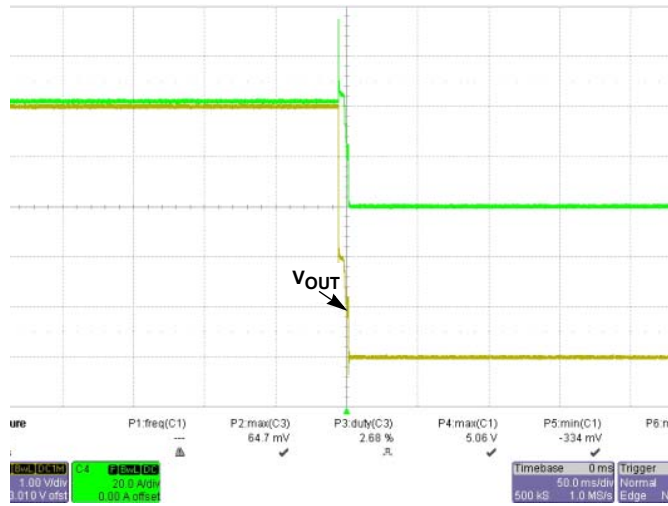

FIGURE 47. I_O OVERSHOOT, SHORT @ $V_{IN} = 75V$, $I_O = 40A$

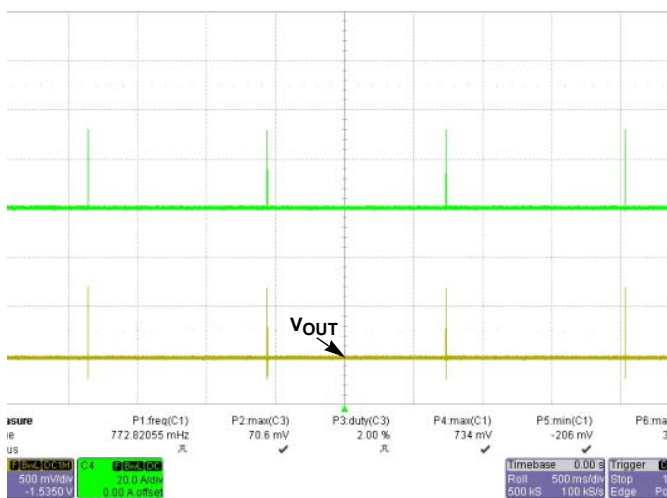

FIGURE 48. START-UP @ OUTPUT TERMINAL SHORT, $V_{IN} = 48V$

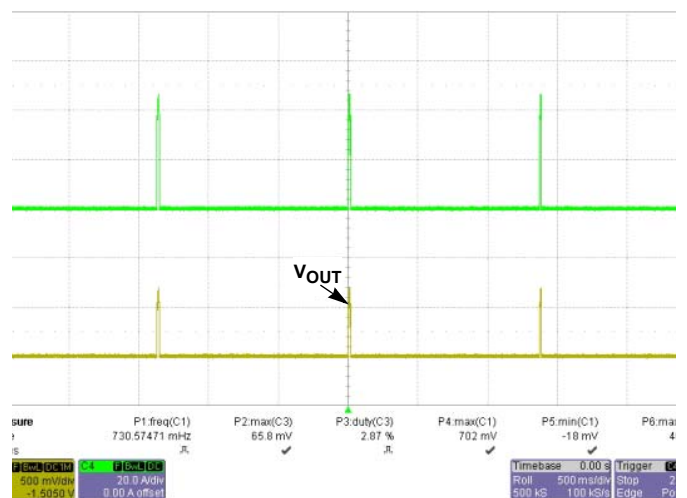

FIGURE 49. START-UP @ OUTPUT TERMINAL SHORT, $V_{IN} = 75V$

Ripple and Noise Test

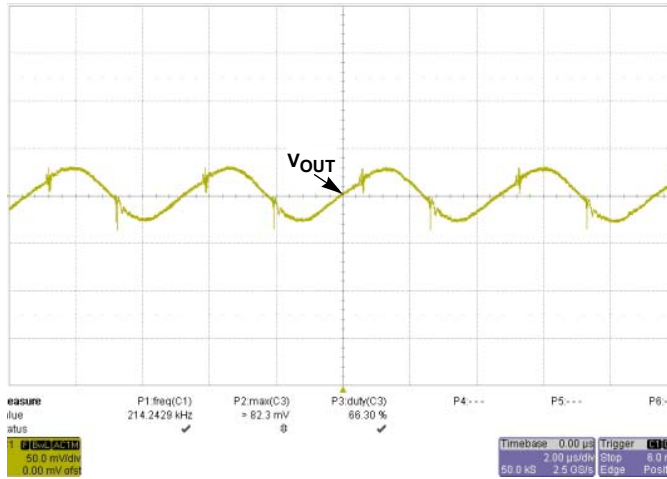

FIGURE 50. PEAK-TO-PEAK = 64mV @ $V_{IN} = 36V$, $I_O = 0A$

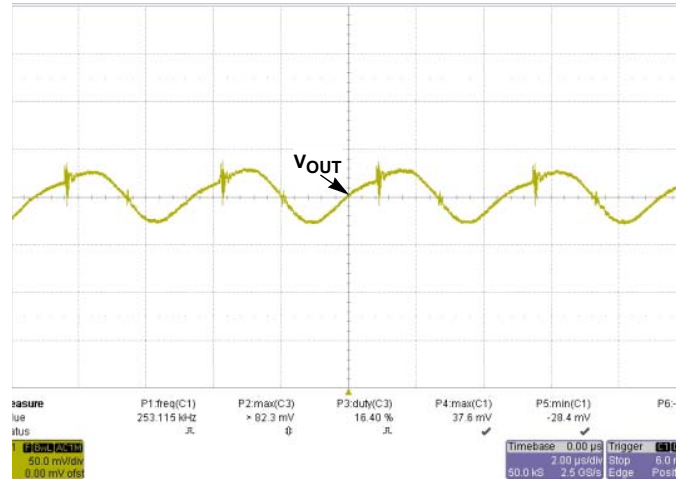

FIGURE 51. PEAK-TO-PEAK = 66mV @ $V_{IN} = 36V$, $I_O = 40A$

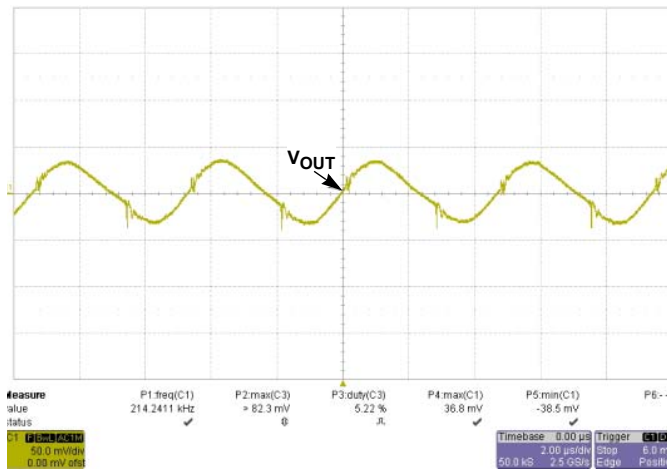

FIGURE 52. PEAK-TO-PEAK = 75.3mV @ $V_{IN} = 48V$, $I_O = 0A$

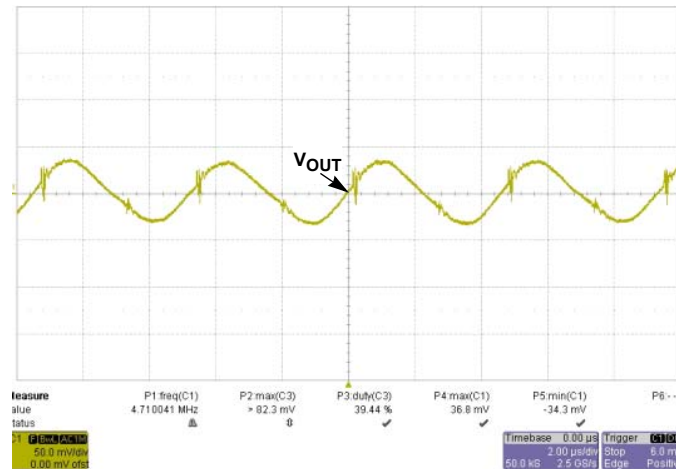

FIGURE 53. PEAK-TO-PEAK = 77mV @ $V_{IN} = 48V$, $I_O = 40A$

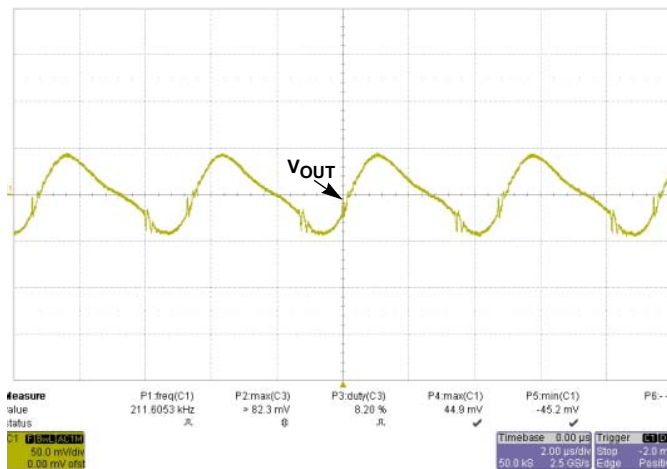

FIGURE 54. PEAK-TO-PEAK = 90mV @ $V_{IN} = 75V$, $I_O = 0A$

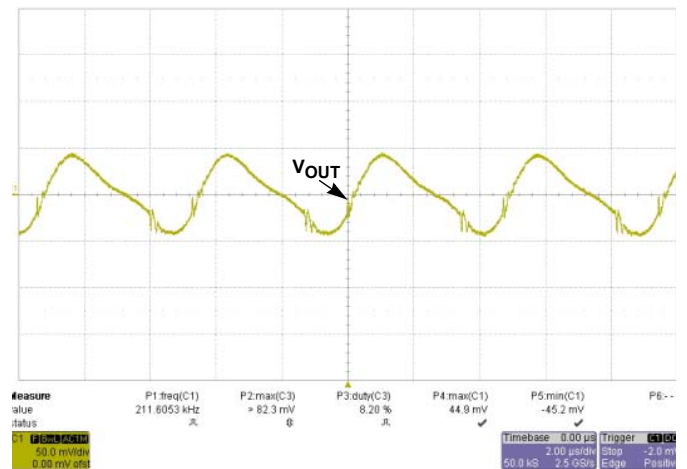

FIGURE 55. PEAK-TO-PEAK = 93mV @ $V_{IN} = 75V$, $I_O = 40A$

Dynamic Response Test

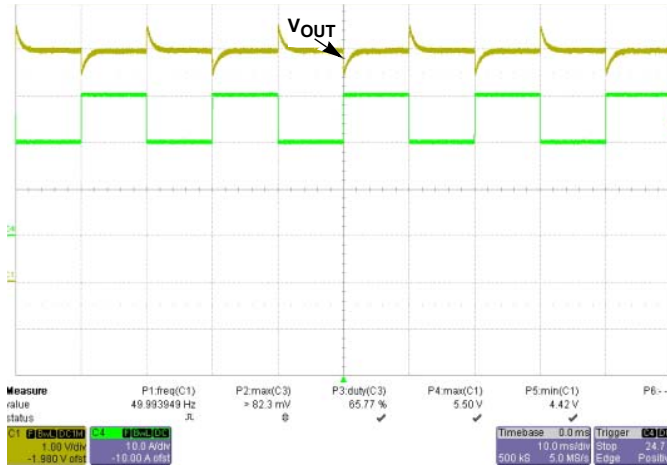

FIGURE 56. ±530mV @ 75%-50%-75% LOAD, 0.2A/μs, V_{IN} = 36V (YELLOW = V_O, GREEN = I_O)

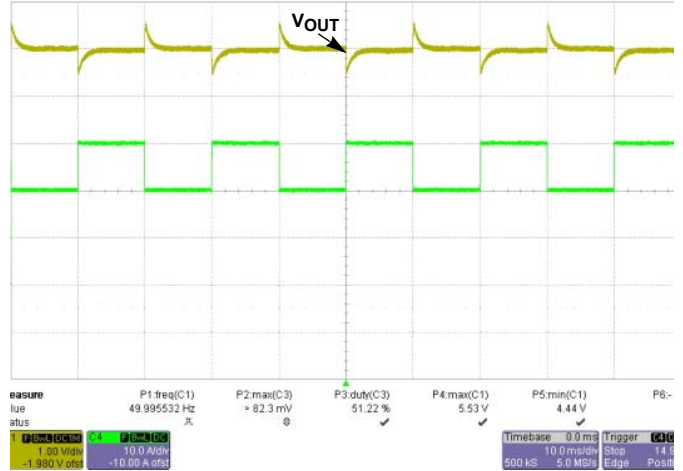

FIGURE 57. ±530mV @ 25%-50%-25% LOAD, 0.2A/μs, V_{IN} = 36V (YELLOW = V_O, GREEN = I_O)

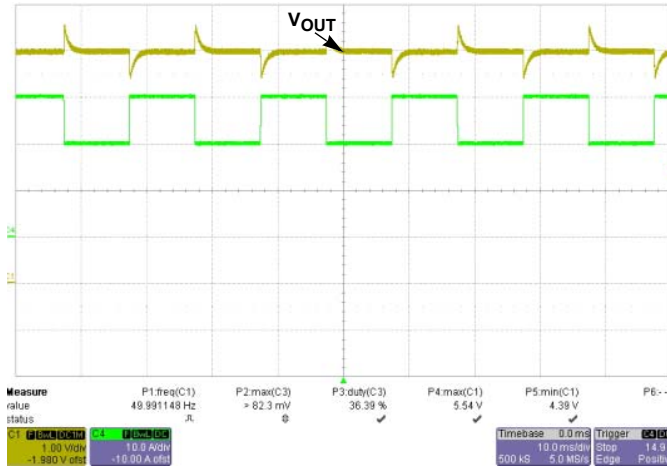

FIGURE 58. ±540mV @ 75%-50%-75% LOAD, 0.2A/μs, V_{IN} = 48V (YELLOW = V_O, GREEN = I_O)

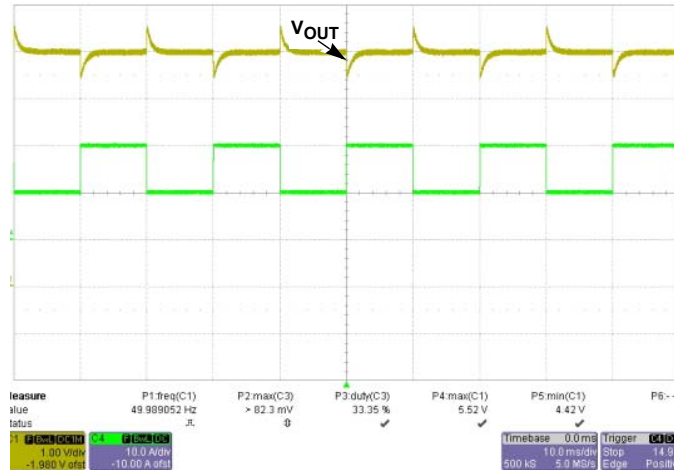

FIGURE 59. ±540mV @ 25%-50%-25% LOAD, 0.2A/μs, V_{IN} = 48V (YELLOW = V_O, GREEN = I_O)

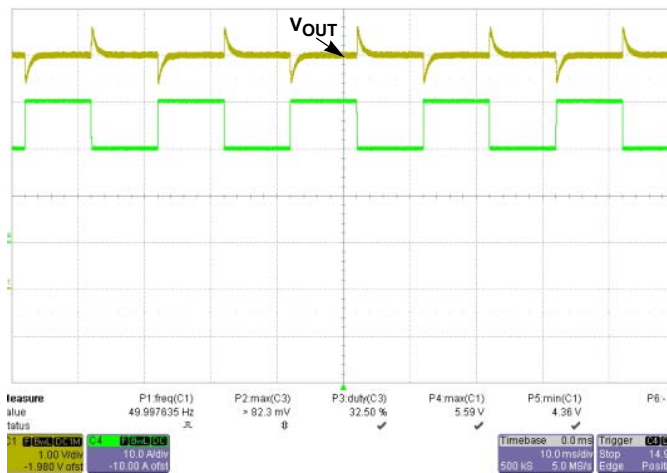

FIGURE 60. ±600mV @ 75%-50%-75% LOAD, 0.2A/μs, V_{IN} = 75V (YELLOW = V_O, GREEN = I_O)

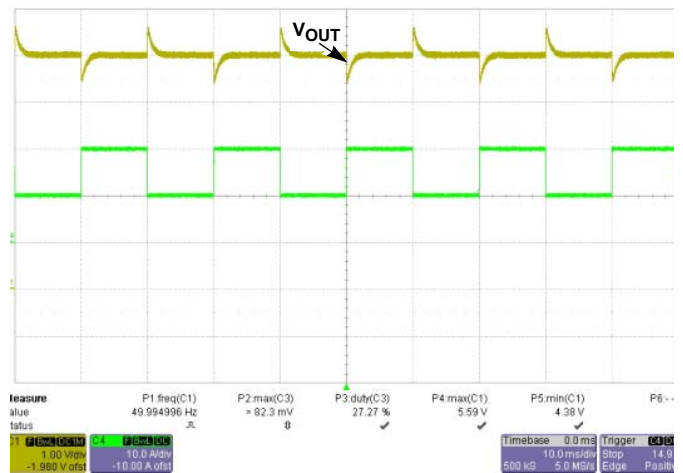

FIGURE 61. ±600mV @ 25%-50%-25% LOAD, 0.2A/μs, V_{IN} = 75V (YELLOW = V_O, GREEN = I_O)

Notice

1. Descriptions of circuits, software and other related information in this document are provided only to illustrate the operation of semiconductor products and application examples. You are fully responsible for the incorporation or any other use of the circuits, software, and information in the design of your product or system. Renesas Electronics disclaims any and all liability for any losses and damages incurred by you or third parties arising from the use of these circuits, software, or information.
2. Renesas Electronics hereby expressly disclaims any warranties against and liability for infringement or any other claims involving patents, copyrights, or other intellectual property rights of third parties, by or arising from the use of Renesas Electronics products or technical information described in this document, including but not limited to, the product data, drawings, charts, programs, algorithms, and application examples.
3. No license, express, implied or otherwise, is granted hereby under any patents, copyrights or other intellectual property rights of Renesas Electronics or others.
4. You shall not alter, modify, copy, or reverse engineer any Renesas Electronics product, whether in whole or in part. Renesas Electronics disclaims any and all liability for any losses or damages incurred by you or third parties arising from such alteration, modification, copying or reverse engineering.
5. Renesas Electronics products are classified according to the following two quality grades: "Standard" and "High Quality". The intended applications for each Renesas Electronics product depends on the product's quality grade, as indicated below.
"Standard": Computers; office equipment; communications equipment; test and measurement equipment; audio and visual equipment; home electronic appliances; machine tools; personal electronic equipment; industrial robots; etc.
"High Quality": Transportation equipment (automobiles, trains, ships, etc.); traffic control (traffic lights); large-scale communication equipment; key financial terminal systems; safety control equipment; etc.
Unless expressly designated as a high reliability product or a product for harsh environments in a Renesas Electronics data sheet or other Renesas Electronics document, Renesas Electronics products are not intended or authorized for use in products or systems that may pose a direct threat to human life or bodily injury (artificial life support devices or systems; surgical implantations; etc.), or may cause serious property damage (space system; undersea repeaters; nuclear power control systems; aircraft control systems; key plant systems; military equipment; etc.). Renesas Electronics disclaims any and all liability for any damages or losses incurred by you or any third parties arising from the use of any Renesas Electronics product that is inconsistent with any Renesas Electronics data sheet, user's manual or other Renesas Electronics document.
6. When using Renesas Electronics products, refer to the latest product information (data sheets, user's manuals, application notes, "General Notes for Handling and Using Semiconductor Devices" in the reliability handbook, etc.), and ensure that usage conditions are within the ranges specified by Renesas Electronics with respect to maximum ratings, operating power supply voltage range, heat dissipation characteristics, installation, etc. Renesas Electronics disclaims any and all liability for any malfunctions, failure or accident arising out of the use of Renesas Electronics products outside of such specified ranges.
7. Although Renesas Electronics endeavors to improve the quality and reliability of Renesas Electronics products, semiconductor products have specific characteristics, such as the occurrence of failure at a certain rate and malfunctions under certain use conditions. Unless designated as a high reliability product or a product for harsh environments in a Renesas Electronics data sheet or other Renesas Electronics document, Renesas Electronics products are not subject to radiation resistance design. You are responsible for implementing safety measures to guard against the possibility of bodily injury, injury or damage caused by fire, and/or danger to the public in the event of a failure or malfunction of Renesas Electronics products, such as safety design for hardware and software, including but not limited to redundancy, fire control and malfunction prevention, appropriate treatment for aging degradation or any other appropriate measures. Because the evaluation of microcomputer software alone is very difficult and impractical, you are responsible for evaluating the safety of the final products or systems manufactured by you.
8. Please contact a Renesas Electronics sales office for details as to environmental matters such as the environmental compatibility of each Renesas Electronics product. You are responsible for carefully and sufficiently investigating applicable laws and regulations that regulate the inclusion or use of controlled substances, including without limitation, the EU RoHS Directive, and using Renesas Electronics products in compliance with all these applicable laws and regulations. Renesas Electronics disclaims any and all liability for damages or losses occurring as a result of your noncompliance with applicable laws and regulations.
9. Renesas Electronics products and technologies shall not be used for or incorporated into any products or systems whose manufacture, use, or sale is prohibited under any applicable domestic or foreign laws or regulations. You shall comply with any applicable export control laws and regulations promulgated and administered by the governments of any countries asserting jurisdiction over the parties or transactions.
10. It is the responsibility of the buyer or distributor of Renesas Electronics products, or any other party who distributes, disposes of, or otherwise sells or transfers the product to a third party, to notify such third party in advance of the contents and conditions set forth in this document.
11. This document shall not be reprinted, reproduced or duplicated in any form, in whole or in part, without prior written consent of Renesas Electronics.
12. Please contact a Renesas Electronics sales office if you have any questions regarding the information contained in this document or Renesas Electronics products.
(Note 1) "Renesas Electronics" as used in this document means Renesas Electronics Corporation and also includes its directly or indirectly controlled subsidiaries.
(Note 2) "Renesas Electronics product(s)" means any product developed or manufactured by or for Renesas Electronics.

(Rev.4.0-1 November 2017)



SALES OFFICES

Renesas Electronics Corporation

<http://www.renesas.com>

Refer to "<http://www.renesas.com/>" for the latest and detailed information.

Renesas Electronics America Inc.
1001 Murphy Ranch Road, Milpitas, CA 95035, U.S.A.
Tel: +1-408-432-8888, Fax: +1-408-434-5351

Renesas Electronics Canada Limited
9251 Yonge Street, Suite 8309 Richmond Hill, Ontario Canada L4C 9T3
Tel: +1-905-237-2004

Renesas Electronics Europe Limited
Dukes Meadow, Millboard Road, Bourne End, Buckinghamshire, SL8 5FH, U.K.
Tel: +44-1628-651-700, Fax: +44-1628-651-804

Renesas Electronics Europe GmbH
Arcadiastrasse 10, 40472 Düsseldorf, Germany
Tel: +49-211-6503-0, Fax: +49-211-6503-1327

Renesas Electronics (China) Co., Ltd.
Room 1709 Quantum Plaza, No.27 ZhichunLu, Haidian District, Beijing, 100191 P. R. China
Tel: +86-10-8235-1155, Fax: +86-10-8235-7679

Renesas Electronics (Shanghai) Co., Ltd.
Unit 301, Tower A, Central Towers, 555 Langao Road, Putuo District, Shanghai, 200333 P. R. China
Tel: +86-21-2226-0888, Fax: +86-21-2226-0999

Renesas Electronics Hong Kong Limited
Unit 1601-1611, 16/F., Tower 2, Grand Century Place, 193 Prince Edward Road West, Mongkok, Kowloon, Hong Kong
Tel: +852-2265-6688, Fax: +852-2886-9022

Renesas Electronics Taiwan Co., Ltd.
13F, No. 363, Fu Shing North Road, Taipei 10543, Taiwan
Tel: +886-2-8175-9600, Fax: +886-2-8175-9670

Renesas Electronics Singapore Pte. Ltd.
80 Bendemeer Road, Unit #06-02 Hyflux Innovation Centre, Singapore 339949
Tel: +65-6213-0200, Fax: +65-6213-0300

Renesas Electronics Malaysia Sdn.Bhd.
Unit 1207, Block B, Menara Amcorp, Amcorp Trade Centre, No. 18, Jln Persiaran Barat, 46050 Petaling Jaya, Selangor Darul Ehsan, Malaysia
Tel: +60-3-7955-9390, Fax: +60-3-7955-9510

Renesas Electronics India Pvt. Ltd.
No.777C, 100 Feet Road, HAL 2nd Stage, Indiranagar, Bangalore 560 038, India
Tel: +91-80-67208700, Fax: +91-80-67208777

Renesas Electronics Korea Co., Ltd.
17F, KAMCO Yangjae Tower, 262, Gangnam-daero, Gangnam-gu, Seoul, 06265 Korea
Tel: +82-2-558-3737, Fax: +82-2-558-5338