

ISL68201-99125DEMO1Z

Demonstration Board

UG086
Rev.2.00
Nov 28, 2017

The [ISL68201](#) is a single-phase synchronous buck PWM controller featuring Intersil's proprietary R4™ Technology, which has extremely fast transient performance, accurately regulated frequency control, and all internal compensation. The ISL68201 supports a wide 4.5V to 24V input voltage range and a wide 0.5V to 5.5V output range. It includes programmable functions and telemetries for easy use and high system flexibility using the SMBus, PMBus, or I²C interface. Refer to the [ISL68201](#) datasheet for more details.

The [ISL99125B](#) is a DrMOS power stage compatible with Intersil's 5V PWM controllers, such as the ISL6398, ISL637x, ISL633x, ISL636x, ISL9585x, and ISL68201. They use a DCR sensing network and associated thermal compensation. Light-load efficiency is supported through a dedicated FCCM control pin. A thermally enhanced 3.5x5 QFN 24 Ld package allows minimal overall PCB real estate.

The ISL68201-99125DEMO1Z is a 6-layer board demonstrating a compact 13mmx13mm 16A synchronous buck converter. The board can be used to evaluate transient performance, fault protections, DC/AC regulations, PMBus programming, power sequencing, margining, and other features.

The PMBus dongle (ZLUSBEVAL3Z USB-to-PMBus adapter) and USB cable are included in the demonstration kit. Intersil's PowerNavigator™ evaluation software can be installed from Intersil's website and be used to evaluate the full PMBus functionality of the part using a PC running Microsoft Windows.

Related Literature

- For a full list of related documents, visit our website
 - [ISL68201](#) product page
 - [ISL99125B](#) product page
- Intersil's [PowerNavigator](#) User Guide

Key Features

- 16A synchronous buck converter with PMBus control
- On-board transient load with adjustable di/dt
- Configurable through resistor pins
- Cascadable PMBus connectors
- Integrated LDOs for a single rail solution
- Enable switch and power-good indicator
- All ceramics solution with SP capacitor footprint option

Target Specifications

- V_{IN} = 4.75V to 14.5V
- V_{OUT} = 3.3V/16A full load
- f_{SW} = 500kHz
- Peak efficiency:
 - 94.4% at 9A/3.3V_{OUT}/12V_{IN}/500kHz
 - 97.1% at 6A/3.3V_{OUT}/5V_{IN}/400kHz
- Output regulation: 3.3V ±0.5%
- I/O capacitor rating: C_{IN} - 16V; C_{OUT} - 6.3V
- Compact size: 13mmx13mm
- With or without PMBus, SMBus, and I²C capability

Ordering Information

PART NUMBER	DESCRIPTION
ISL68201-99125DEMO1Z	ISL68201-99125 Demonstration Board (Items shipped: Demonstration board, dongle, and USB cable)

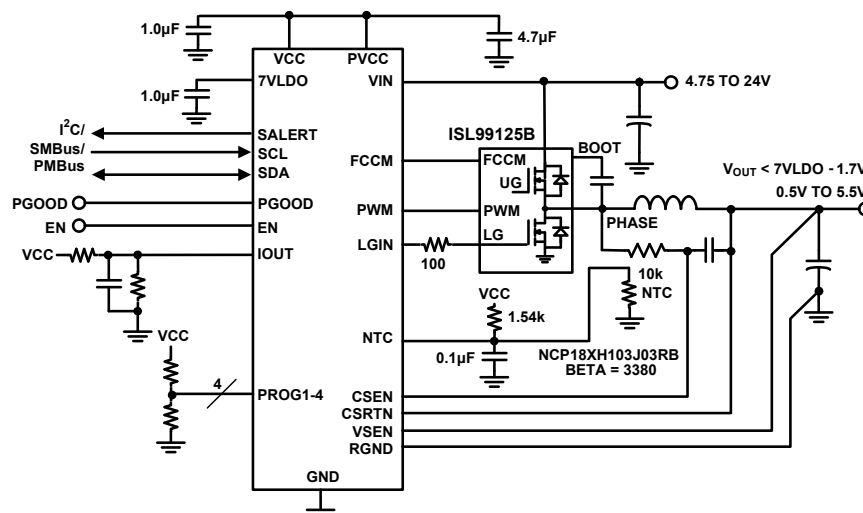

FIGURE 1. ISL68201-99125DEMO1Z SIMPLIFIED SCHEMATIC



FIGURE 2. DEMONSTRATION BOARD TOP VIEW



FIGURE 3. DEMONSTRATION BOARD BOTTOM VIEW

Demonstration Board Description

The ISL68201-99125DEMO1Z provides all circuitry required to demonstrate the key features of the ISL68201. A majority of the features of the ISL68201 are available on this demonstration board, such as optimal transient response with Intersil's R4 Modulator, 8-bit programmable boot voltage levels, selectable switching frequency in continuous conduction mode, power-good monitor for soft-start and fault detection, over-temperature protection, output overcurrent and short-circuit protection, and output overvoltage protection.

[Figure 1 on page 1](#) shows a simplified schematic diagram of the ISL68201-99125DEMO1Z board. [Figure 6 on page 7](#) shows the detailed 16A buck solution schematics, while [Figure 7 on page 8](#) shows the I/O connectors, auxiliary circuits and on-board transient circuits. [Figures 8 through 33](#) show typical performance data and [Figures 34 through 41](#) show the PCB board layout. The default programming pins setting is shown in the lower left corner of [Figure 6](#), and the Bill of Materials (BOM) is included for reference beginning on [page 9](#).

The ISL68201-99125DEMO1Z board can run by itself without a serial bus communication. The operational configuration is fully programmable using the programming pins (PROG1-4).

The ISL68201 however, uses the PMBus/SMBus/I²C protocol and provides the flexibility for digital power management and performance optimization before finalizing the hardware configuration on the programming pins.

The buck regulator in the ISL68201-99125DEMO1Z board is a single input rail design, that is, everything is biased by the input supply (typically 12V). The resistor divider on the EN pin (R₄ and R₁₂) can set the input supply undervoltage protection level and its hysteresis. The "ENABLE" switch is a hardware operational control. Alternately, the serial bus ON_OFF_CONFIG and OPERATION commands can be used for software operational control.

Furthermore, an on-board transient load, as shown in [Figure 4 on page 3](#), with di/dt and load step amplitude is controlled by a function generator. Because this auxiliary circuit draws more than 10mA of current, the jumper on JP4 should be removed for accurate efficiency measurement.

Intersil's PowerNavigator evaluation software is compatible with Windows operating systems and can be used to evaluate the serial bus functionality of the ISL68201. The software and user guide can be found at <http://www.intersil.com/powernavigator>.

Quick Start Guide

Standalone Operation

1. Set the ENABLE switch to the "OFF" position.
2. Connect a power supply (off) to input connectors (J4-VIN and J3-GND).
3. Set the input power supply voltage level (no more than 15V) and current limiting (no more than 1A for 0A load).
4. Turn the power supply on.
5. Set the ENABLE switch to the "ON" position.
6. Increase the power supply current limit enough to support more than the full load.
7. Apply load to the output connectors (J1-VOUT and J2-SGND).
8. Monitor the operation using an oscilloscope.

PMBus Operation

1. Connect the supplied dongle to J8.
2. Connect the USB cable from the computer to the dongle.
3. After the input supply powers up, open the PowerNavigator evaluation software.
4. Select the detected ISL68201 device (Address - 7Fh) and follow the instructions in the PowerNavigator user guide.
5. Monitor and configure the board using PMBus commands in the evaluation software.

Configuration

The default programming pins setting of the ISL68201-99125DEMO1Z board can be found at the resistor reader table on the lower left corner of [“ISL68201-99125DEMO1Z Schematics” on page 7](#) or read back using the [PowerNavigator](#) software. Each PMBus command can be loaded or programmed using PowerNavigator. Note that the ISL68201 does not have NVM to store the operational configuration; however, it can be set by the resistor programming pins (PROG1-4) or programmed by the serial bus master before powering up. If a serial bus master is available in the system, the ISL68201-based rail can be fully controlled using software for the power-up/power-down sequencing and operational configuration without a soldering iron.

Load Transient

The on-board transient load can be controlled by a function generator, whose inputs are connected to FG_DRIVE2 and FG_GND2. The function generator's output is terminated by R₄₂ at the input terminal, and its amplitude and dv/dt set the load amplitude and di/dt on the 50mΩ load (R_{LT1}/R_{LT2}). The transient load can be monitored with a scope probe on TP15. Note that the duty cycle of applied load should be less than 10% duty cycle with <10ms pulse width to keep the average power of R_{LT1}/R_{LT2} less than its power rating.

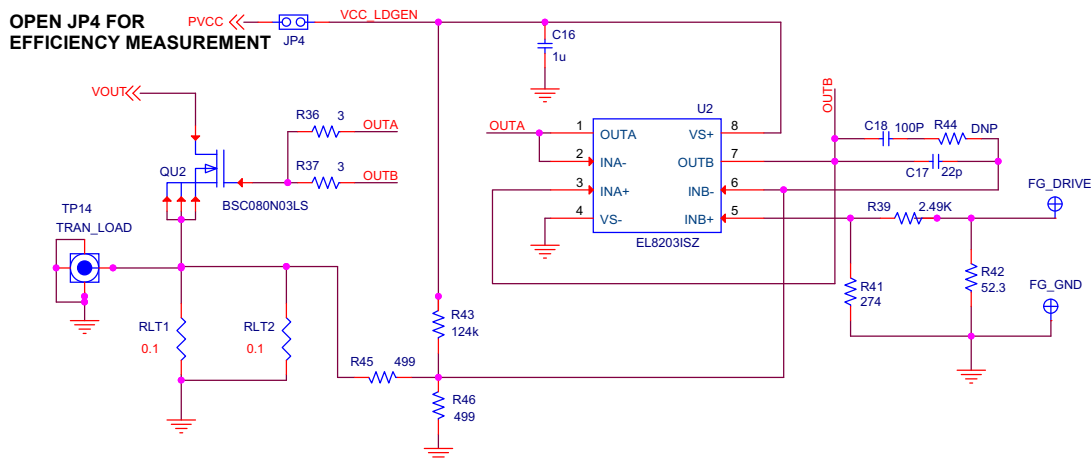

FIGURE 4. ON-BOARD LOAD TRANSIENT

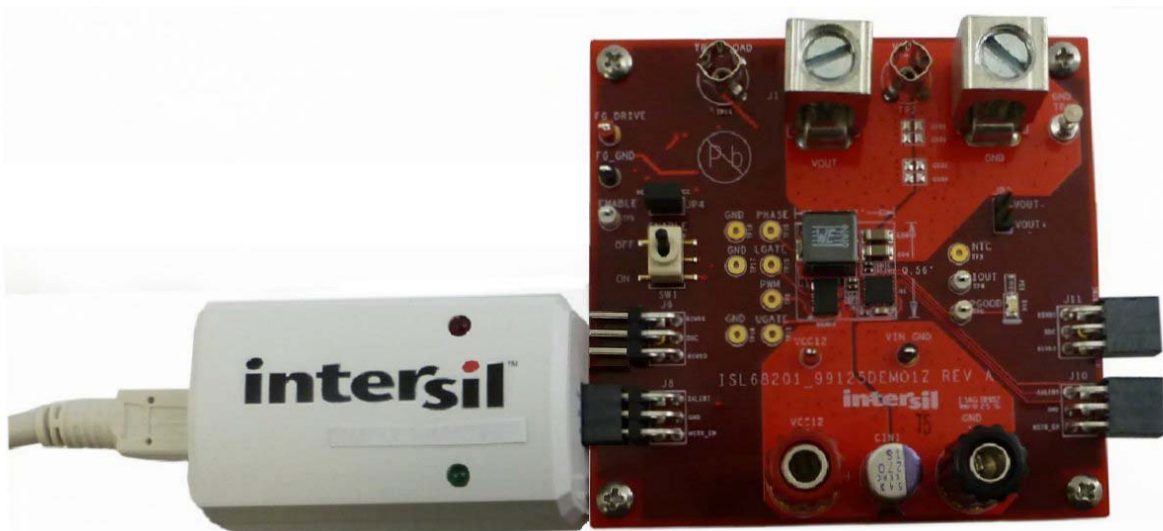

FIGURE 5. ISL68201-99125DEMO1Z DEMONSTRATION KIT SETUP

Design Modifications

Any modifications to the design will require new L/DCR matching for a different inductor, a divider on the PROG pins for a different operational configuration, R_{SEN1} for OCP, an I_{OUT} network for accurate digital I_{OUT}, a higher input capacitor rating to support higher than 16V input, and a higher output capacitor rating to support higher than 4V output. Refer to the [ISL68201](#) datasheet and [PowerNavigator](#) software for proper design modifications including L/DCR matching, thermal compensation, OCP, and digital I_{OUT} fine tuning.

Three examples are provided in [Table 1](#), showing the recommended design modifications to accommodate the

application cases with 5V and 3.3V output voltages. Some fine-tuning might be needed depending upon the rework and final layout design.

For the 5V input voltage applications with $4.5V < V_{IN} < 5.5V$ requirement, the “VIN”, “VCC”, “PVCC” and “7VLD0” pins should be shorted together to connect with the input supply for optimal performance. R₁₂ should be removed as well.

Note that all devices in the same bus should set different addresses for unique identification and proper communication. JP2, 3, 9 and 10 connectors are designed to cascade many Intersil's solutions for easy communication and system evaluation before system integration and design.

TABLE 1. DESIGN EXAMPLES

REFERENCE DESIGNATOR	5.0V AT 16A	3.3V AT 30A	1.0V AT 20A	COMMENTS
L1	No change	470nH, 0.165mΩ Vendor: Würth Electronic; Part Number: 744309047	220nH, 0.29mΩ Vendor: Würth Electronic; Part Number: 744307022	Reduce output ripple current; higher voltage output typically needs higher inductance.
CO5, CO6, CO8, CO9	No change		220µF/X5R/4V/1206 Vendor: Murata; Part Number: GRM31CR60G227ME11	Increase C _{OUT} rating to support higher V _{OUT} . Also capacitance of ceramic capacitors decreases with increased output voltage.
PROG1 (DC)	DFh	BFh	80h	Set correct V _{BOOT} = V _{OUT}
R ₃	147k, 1%	No change	75k, 1%	
PROG2 (DD)	A0h	BFh	BFh	Set different PMBus addresses as needed TCOMP = 15 PFM disabled
R ₅	105k, 1%	DNP	DNP	
R ₆	DNP	105k, 1%	105k, 1%	
PROG3 (DE)	0Dh	0Dh	0Dh	Set A _V = 42 for 1.0V f _{SW} = 500kHz OCP = Retry 25kHz clamp disabled
R ₈	No change	No change	19.6k, 1%	
R ₉	No change	No change	20k, 1%	
PROG4 (DF)	08h	08h	00h	Set RR = 200k for 1.0V SS = 1.25mV/µs AVMLTI = 1x
R ₁₀	No change	No change	10k, 1%	
R ₁₁	No change	No change	DNP	
CC1	No change	1.0µF	No change	L/DCR matching
R _{P1}	No change	3.57k, 1%	9.09k, 1%	
R _{SEN1}	No change	62, 1%	75, 1%	Set OCP
R ₁₃	No change	15k, 1%	9.53k, 1%	Set I _{OUT} to 1A/1A slope
R ₁₄	TBD	TBD	TBD	Pull-up value depends upon final layout design.

NOTE: Some fine-tuning might be needed depending upon the rework and final layout design.

Design and Layout Considerations

To ensure a first pass design, the schematics design must be done correctly and the board must be carefully laid out.

As a general rule, power layers should be close together, either on the top or bottom of the board, with the weak analog or logic signal layers on the opposite side of the board or internal layers. The ground-plane layer should be in between power layers and the signal layers to provide shielding. Often, the layer below the top and the layer above the bottom should be the ground layers.

DC/DC converters have two sets of components: the power components and the small signal components. The power components are the most critical because they switch large amounts of energy. The small signal components connect to sensitive nodes or supply critical bypassing current and signal coupling.

The power components should be placed first. These include MOSFETs, input and output capacitors, and the inductor. Keeping the distance between the power train and the control IC short helps keep the gate drive traces short. These drive signals include the LGATE, UGATE, GND, PHASE, and BOOT.

When placing MOSFETs, try to keep the source of the upper MOSFETs and the drain of the lower MOSFETs as close as thermally possible. Input high frequency capacitors should be placed close to the drain of the upper MOSFETs and the source of the lower MOSFETs. Place the output inductor and output capacitors between the MOSFETs and the load. High frequency output decoupling capacitors (ceramic) should be placed as close as possible to the decoupling target, making use of the shortest connection paths to any internal planes. Place the components in such a way that the area under the IC has fewer noise traces with high dv/dt and di/dt , such as gate signals, phase node signals, and VIN plane.

[Tables 2](#) and [3](#) provide a design and layout checklist that a designer should pay attention to.

TABLE 2. DESIGN AND LAYOUT CHECKLIST

PIN NAME	NOISE SENSITIVITY	DESCRIPTION
EN	Yes	There is an internal 1 μ s filter. Decoupling the capacitor is NOT needed. However, if needed, use a low time constant one to avoid too large a shutdown delay.
VIN	Yes	Place a 16V+ X7R 1 μ F in close proximity to the VIN pin and the system ground plane.
7VLDO	Yes	Place a 10V+ X7R 1 μ F in close proximity to the 7VLDO pin and the system ground plane.
VCC	Yes	Place a X7R 1 μ F in close proximity to the VCC pin and the system ground plane.

TABLE 2. DESIGN AND LAYOUT CHECKLIST (Continued)

PIN NAME	NOISE SENSITIVITY	DESCRIPTION
SCL, SDA	Yes	50kHz to 1.25MHz signal when the SMBus, PMBus, or I ² C is sending commands. Pairing up with SALERT and routing carefully back to the SMBus, PMBus, or I ² C master. 20 mils spacing within SDA, SALERT, and SCL; and more than 30 mils to all other signals. Refer to the SMBus, PMBus, or I ² C design guidelines and place proper terminated (pull-up) resistance for impedance matching. Tie them to GND when not used.
SALERT	No	Open-drain and high dv/dt pin during transitions. Route it in the middle of SDA and SCL. Tie it to GND when not used.
PGOOD	No	Open-drain pin. Tie it to ground when not used.
RGND, VSEN	Yes	Differential pair routed to the remote sensing points with sufficient decoupling ceramics capacitors and not across or go above/under any switching nodes (BOOT, PHASE, UGATE, LGATE) or planes (VIN, PHASE, VOUT) even though they are not in the same layer. At least 20 mils spacing from other traces. DO NOT share the same trace with CSRTN.
CSRTN	Yes	Connect to the output rail side of the output inductor or current sensing resistor pin with a series resistor in close proximity to the pin. The series resistor sets the current gain and should be within 40 Ω and 3.5k Ω . Decoupling ($\sim 0.1\mu$ F/X7R) on the output end (not the pin) is optional and might be required for long sense traces or challenging layouts.
CSEN	Yes	Connect to the phase node side of the output inductor or current sensing resistor pin with L/DCR or ESL/R _{SEN} matching network in close proximity to the CSEN and CSRTN pins. Differentially routing back to the controller with at least 20 mils spacing from other traces. Should NOT cross or go above/under the switching nodes [BOOT, PHASE, UGATE, LGATE] and power planes (VIN, PHASE, VOUT) even though they are not in the same layer.
NTC	Yes	Place NTC 10k (Murata, NCP15XH103J03RC, $\beta = 3380$) in close proximity to the output inductor's output rail, not close to MOSFET side; the return trace should be 20 mils away from other traces. Place 1.54k Ω pull-up and decoupling capacitor (typically 0.1 μ F) in close proximity to the controller. The pull-up resistor should be exactly tied to the same point as the VCC pin, not through an RC filter. If not used, connect this pin to VCC.
IOUT	Yes	Scale R so that the IOUT pin voltage is 2.5V at 63.875A load. Place R and C in general proximity to the controller. The time constant of RC should be sufficient as an averaging function for the digital I _{OUT} . An external pull-up resistor to VCC is recommended to cancel I _{OUT} offset at 0A load.

TABLE 2. DESIGN AND LAYOUT CHECKLIST (Continued)

PIN NAME	NOISE SENSITIVITY	DESCRIPTION
PROG1-4	No	A resistor divider must be referenced to the VCC pin and the system ground. They can be placed anywhere. DO NOT use decoupling capacitors on these pins.
GND	Yes	Directly connect to low noise area of the system ground. The GND PAD should use at least four vias. Separate analog ground and power ground with a 0Ω resistor is NOT recommended.
FCCM	No	DO NOT make it across or under external components of the controller. Keep it at least 20 mils away from sensitive nodes.
PWM	No	DO NOT make it across or under external components of the controller. Keep it at least 20 mils away from any other traces.
LGIN	No	Keep it at least 20 mils away from sensitive nodes. A series 100Ω resistor to low-side gate signal is required for noise attenuation.
PVCC	Yes	Place an X7R 4.7μF in proximity to the PVCC pin and the system ground plane.

TABLE 3. TOP LAYOUT TIPS

NUMBER	DESCRIPTION
1	The layer next to the controller (top or bottom) should be a ground layer. Separate analog ground and power ground with a 0Ω resistor is highly NOT recommended. Directly connect GND PAD to low noise area of the system ground with at least four vias.
2	Never place the controller and its external components above or under VIN plane or any switching nodes.
3	Never share CSRTN and VSEN on the same trace.
4	Place the input rail decoupling ceramic capacitors closely to the high-side FET. Never use only one via and a trace connect. The input rail decoupling ceramics capacitors must connect to VIN and GND planes.
5	Place all decoupling capacitors in close proximity to the controller and the system ground plane.
6	Connect remote sense (VSEN and RGND) to the load and ceramic decoupling capacitors nodes; never run this pair below or above switching noise plane.
7	Always double check critical component pinouts and their respective footprints.

ISL68201-99125DEMO1Z Schematics (Continued)

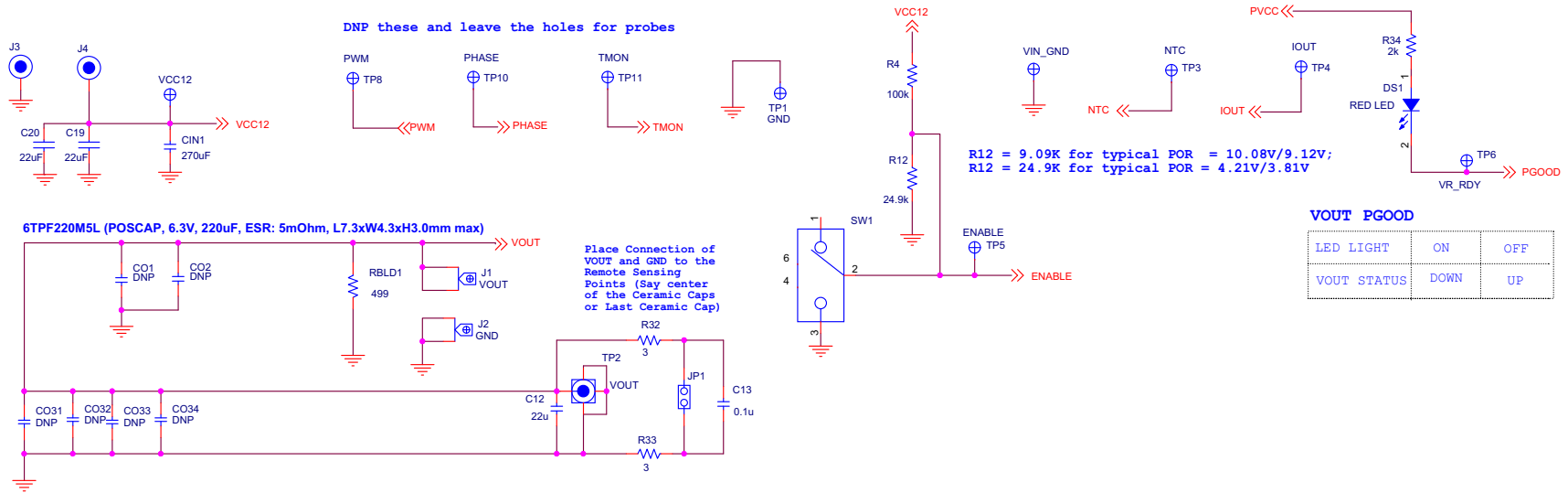

BOARD TO BOARD INTERFACE

ON LEFT OF BOARD (MALE)

ON RIGHT OF BOARD (FEMALE)

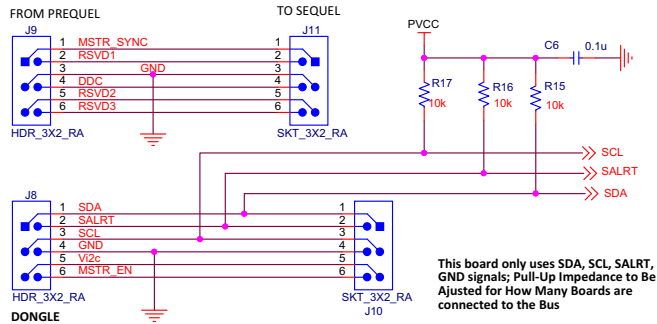

On-Board Load Transient Open Jumper for Efficiency Measurement

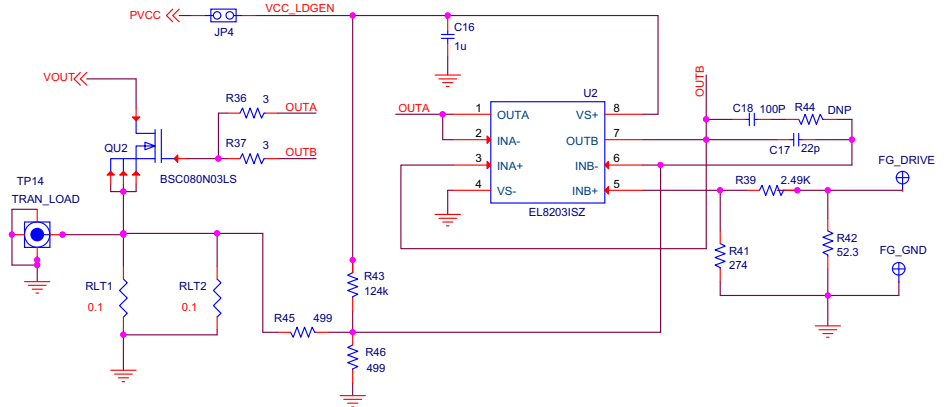

FIGURE 7. I/O CONNECTORS, AUXILIARY CIRCUITS AND ON-BOARD TRANSIENT LOAD SCHEMATICS (2 OF 2)

Bill of Materials

QTY	REFERENCE DESIGNATOR	DESCRIPTION	PCB FOOTPRINT	MANUFACTURER	PART NUMBER
1	U1	R4 Wrapper	QFN24_157X157_197_EPC	Intersil	ISL68201IRZ-REVD
1	DrMOS	25A DrMOS PWR MODULE	QFN_32P_5x5	Intersil	ISL99125BDRZ-T
1	CIN1	270µF/16V/8x9/10mΩ	CAPR_315X275_150_P	Sanyo	16SEPC270MX
1	C1	4.7µF/6.3V/X5R	SM0603	Venkel	C0603X5R6R3-475KNE
3	C2, C3, C4	1.0µF/25V/X5R	SM0402	TDK	C1005X5R1C105K050BC
1	C5	22nF/25V/X7R	SM0402	Venkel	C0402X7R250-223KNE
1	C6	0.1µF/16V/X7R	SM0603	Murata	GRM39X7R104K016AD
3	CB1, CV1, CNTC1	0.1µF/16V/X5R	SM0402	Venkel	GRM155R61A104KA01D
4	C10, C11, C19, C20	22µF/16V/X5R	SM0805	Venkel	C0805X5R160-226KNE
4	CO5, CO6, CO8, CO9	100µF/6.3V/X5R	SM1206	Murata	GRM21BR60J107ME11
1	L1	680nH, 1.72mΩ	ind_we_744302010	Würth Electronics	744307022
1	R2	75kΩ, 1%	SM0402	Venkel	CR0402-16W-7502FT
1	R4	100kΩ, 1%	SM0603	Venkel	CR0603-10W-1003FT
1	R5	105kΩ, 1%	SM0402	Venkel	CR0402-16W-1053FT
1	R8	19.6kΩ, 1%	SM0402	Panasonic	ERJ2REKF1962V
1	R9	20kΩ, 1%	SM0402	Vishay/Dale	CRCW040220K0FKED
1	R10	10kΩ, 1%	SM0402	Panasonic	ERJ-2RKF1002X
3	R15, R16, R17	10kΩ, 1%	SM0603	Venkel	CR0603-10W-1002FT
1	R12	24.9kΩ, 1%	SM0603	Yageo	RC0603FR-0724K9L
1	R13	9.53kΩ, 1%	SM0402	Venkel	CR0402-16W-9531FT
1	R21	1kΩ, 1%	SM0402	Venkel	CR0402-16W-102JT
1	RBLD1	499Ω, 1%	SM0603	Venkel	CR0603-10W-4990FT
1	RNTC1	10kΩ NTC, 5%, β = 3380	SM0402	Murata	NCP15XH103J03RC
1	RP1	9.09kΩ, 1%	SM0402	Venkel	CR0402-16W-9091FT
1	RSEN1	75Ω, 1%	SM0402	Panasonic	ERJ-2RKF75R0X
1	RTM1	1.54kΩ, 1%	SM0402	Panasonic	ERJ-2RKF1541X
DEMONSTRATION BOARD SPECIFIC AUXILIARY PARTS BILL OF MATERIALS					
1	U2	Dual Amp/500MHz/5V	SOIC8	Intersil	EL8203ISZ
1	QU2	8mΩ N-MOSFET	LPAK	Infineon	BSC080N03LS G
1	DS1	LED/RED/0805/CLEAR	SM0805	Würth Elektronik	150080RS75000
1	SW1	Enable Switch	GT11SC	C&K Division	GT11MSCBE
1	C12	22µF/6.3V/X5R	SM0603	Venkel	GRM21BR60J226ME39L
1	C13	0.1µF/16V/X7R	SM0603	Murata	GRM39X7R104K016AD
1	C16	1.0µF/25V/X5R	SM0402	TDK	C1005X5R1C105K050BC
1	C17	22pF/50V/C0G	SM0603	Venkel	C0603C0G500-220JNE
1	C18	100pF/50V/C0G	SM0603	Panasonic	ECJ-1VC1H101J
2	J1, J2	Screw Terminal	B2C-PCB	International Hydraulics Inc	B2C-PCB
1	J3	Female Banana Jack, Black	111-07xx-001	Johnson Components	111-0703-001

Bill of Materials (Continued)

QTY	REFERENCE DESIGNATOR	DESCRIPTION	PCB FOOTPRINT	MANUFACTURER	PART NUMBER
1	J4	Female Banana Jack, Red	111-07xx-001	Johnson Components	111-0702-001
2	J8, J9	CONN-HEADER, 2x3, BRKAWY, 2.54mm, TIN	CONN6	Samtec	TSW-103-08-T-D-RA
2	J10, J11	CONN-SOCKET STRIP, TH, 2x3, 2.54mm, TIN	CONN6	Samtec	SSQ-103-02-T-D-RA
2	JP1, JP4	2-pin 0.1" spacing Jumper	CONN2	Berg/FCI	69190-202HLF
1	TP1	Probe Ground	TP-150C100P-RTP	Keystone	1514-2
2	TP2, TP14	Probe Jack	TEK131-4353-00	Tektronix	131-4353-00
4	TP3, TP4, TP5, TP6	Test Point	MTP500x	Keystone	5002
2	VCC12, FG_DRIVE	Test Point RED	MTP500x	Keystone	5000
2	VIN_GND, FG_GND	Test Point BLACK	MTP500x	Keystone	5001
4	R32, R33, R36, R37	3 Ω , 1%	SM0603	Venkel	CR0603-10W-03R0FT
1	R34	2k Ω , 1%	SM0603	KOA	RK73H1JTDD2001F
1	R39	2.49k Ω , 1%	SM0603	KOA	RK73H1JTDD2491F
1	R42	52.3 Ω , 1%	SM0603	Panasonic	ERJ-3EKF52R3V
1	R41	274 Ω , 1%	SM0603	Venkel	CR0603-10W-2740FT
1	R43	124k Ω , 1%	SM0603	Yageo	9C06031A1243FKHFT
2	R45, R46	499 Ω , 1%	SM0603	Venkel	CR0603-10W-4990FT
2	RLT1, RLT2	0.1 Ω , 1%	SM2512	CTS Resistor	73L7R10J

Performance Data

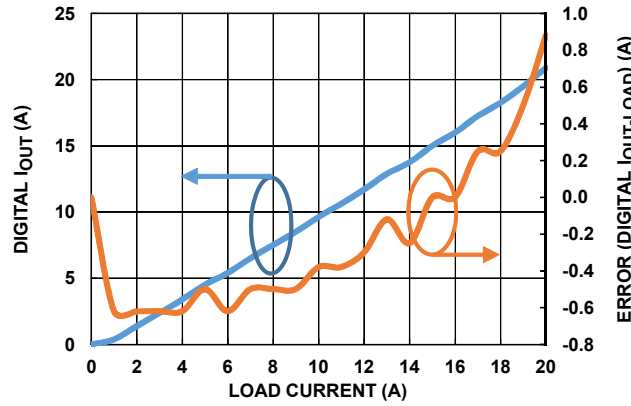

FIGURE 8. TYPICAL DIGITAL OUTPUT CURRENT

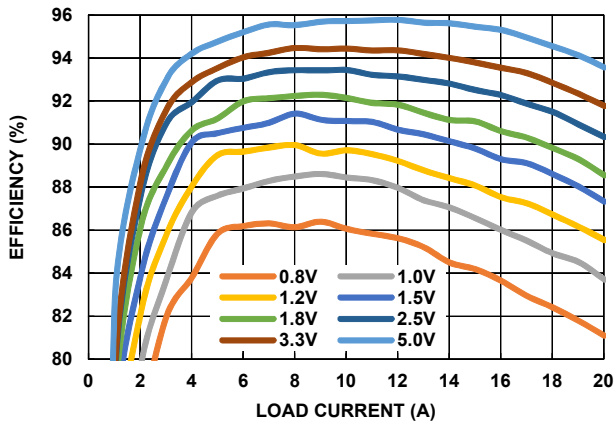

FIGURE 9. EFFICIENCY, $V_{IN} = 12V$, $f_{SW} = 400kHz$

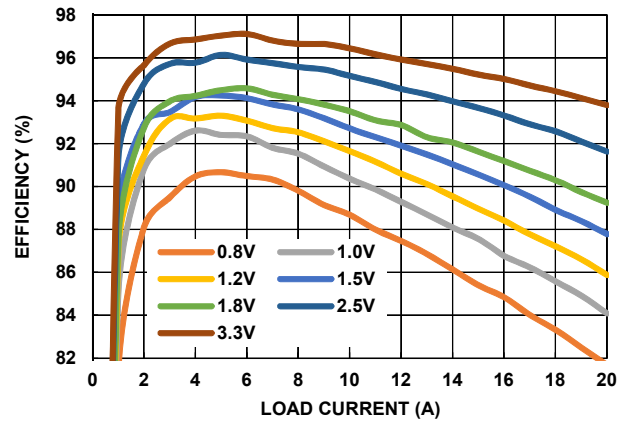

FIGURE 10. EFFICIENCY, $V_{IN} = 5V$, $f_{SW} = 400kHz$

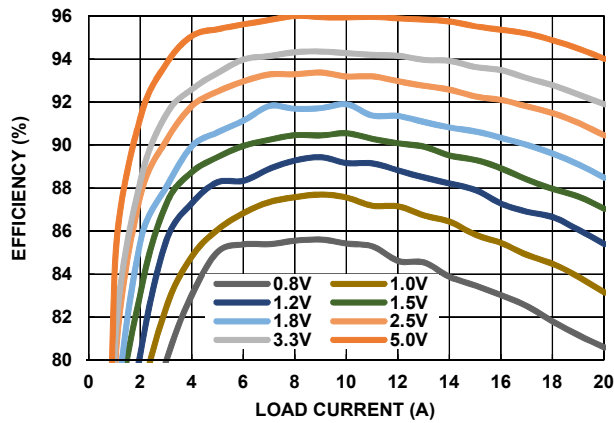

FIGURE 11. EFFICIENCY, $V_{IN} = 12V$, $f_{SW} = 500kHz$

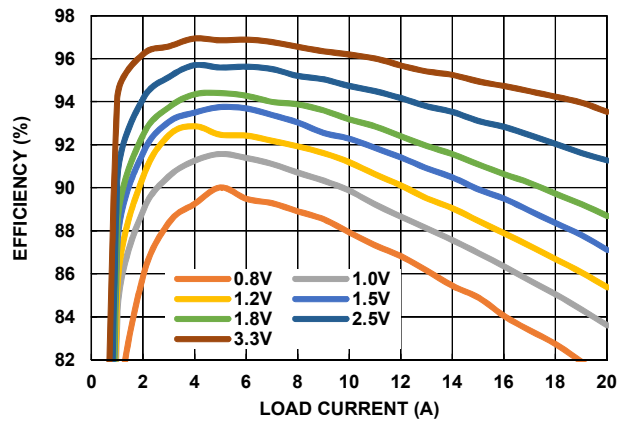

FIGURE 12. EFFICIENCY, $V_{IN} = 5V$, $f_{SW} = 500kHz$

Performance Data (Continued)

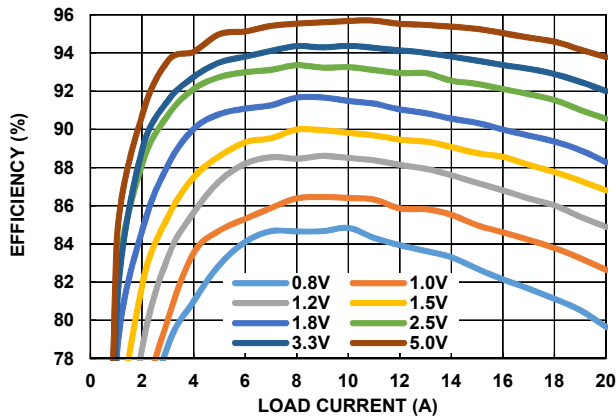

FIGURE 13. EFFICIENCY, $V_{IN} = 12V$, $f_{SW} = 600kHz$

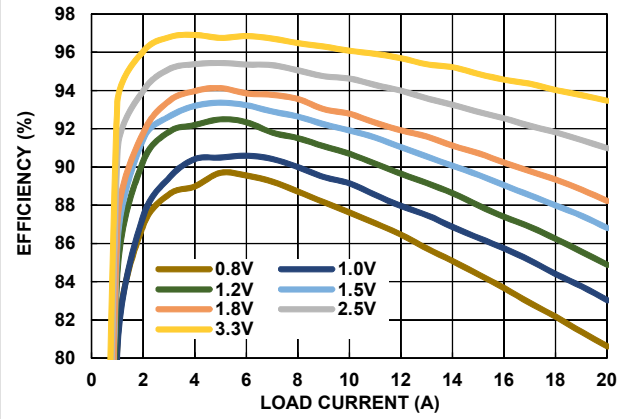

FIGURE 14. EFFICIENCY, $V_{IN} = 5V$, $f_{SW} = 600kHz$

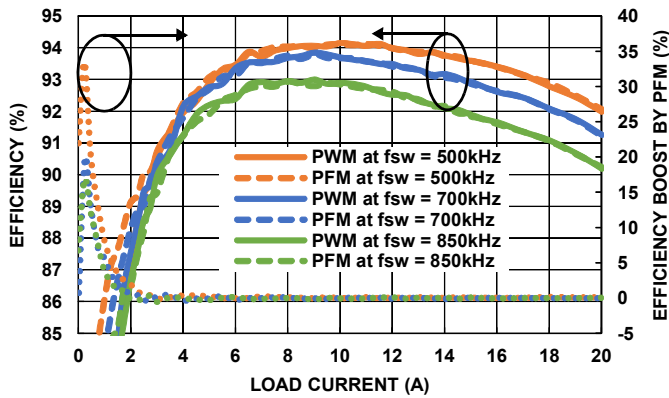

FIGURE 15. EFFICIENCY COMPARISON OF PWM MODE AND PFM ENABLED MODE, $V_{IN} = 12V$, $V_{OUT} = 3.3V$

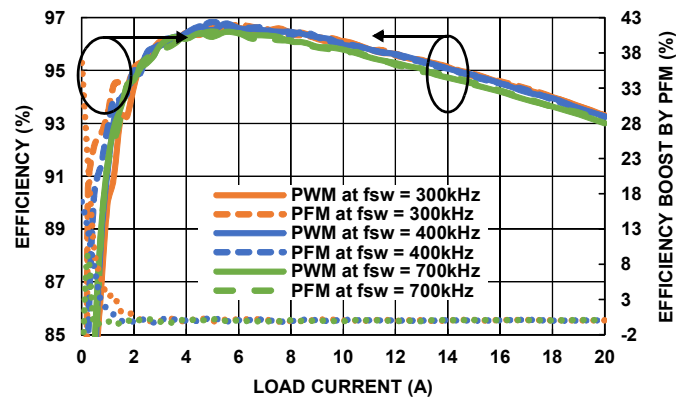

FIGURE 16. EFFICIENCY COMPARISON OF PWM MODE AND PFM ENABLED MODE, $V_{IN} = 5V$, $V_{OUT} = 3.3V$

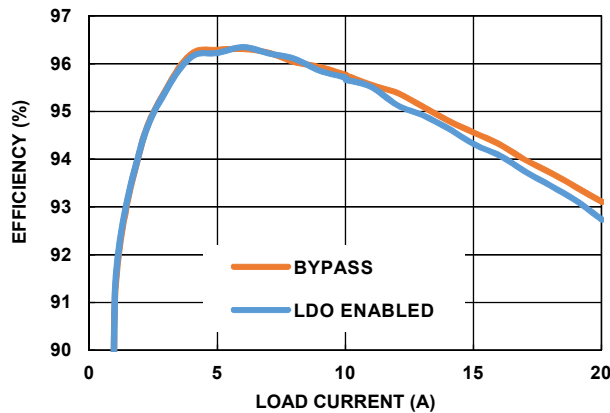

FIGURE 17. EFFICIENCY COMPARISON OF LDO ENABLED AND BYPASSED, $V_{IN} = 5V$, $V_{OUT} = 3.3V$, $f_{SW} = 500kHz$

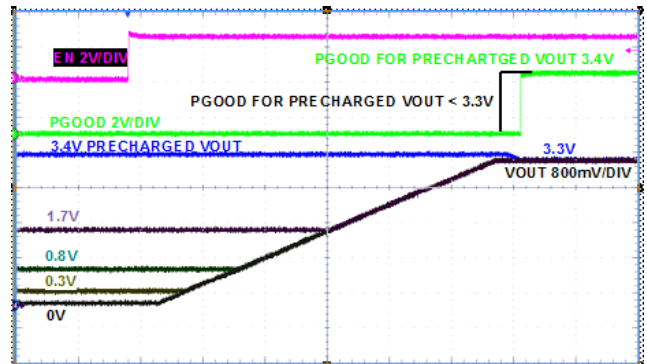

FIGURE 18. POWER-UP WITH/WITHOUT PRECHARGED LOAD

Performance Data (Continued)

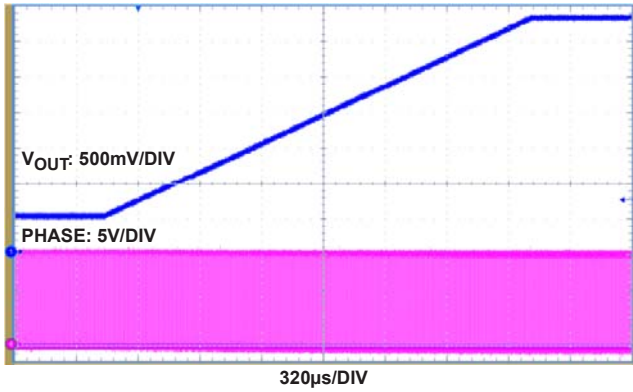

FIGURE 19. V_{OUT} RAMP-UP FROM 0.5V TO 3.3V IN PWM MODE)

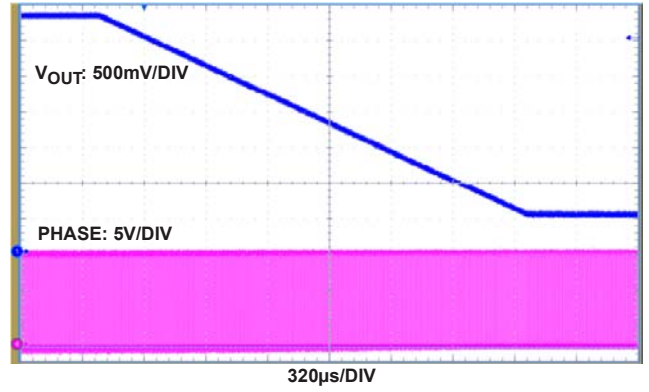

FIGURE 20. V_{OUT} RAMP-DOWN FROM 3.3V TO 0.5V IN PWM MODE)

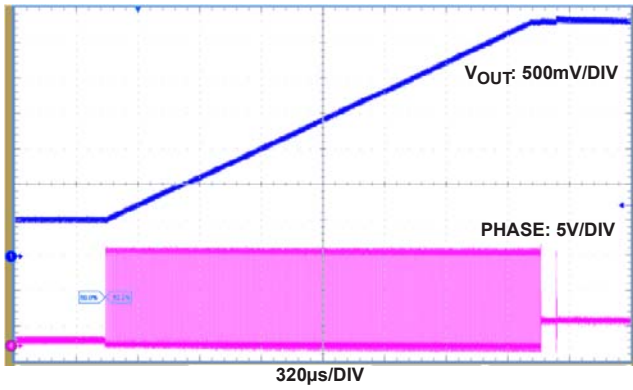

FIGURE 21. V_{OUT} RAMP-UP FROM 0.5V TO 3.3V IN PFM MODE

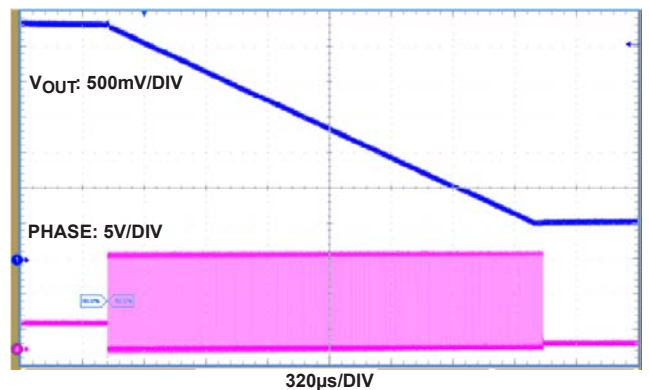

FIGURE 22. V_{OUT} RAMP-DOWN FROM 3.3V TO 0.5V IN PFM MODE)

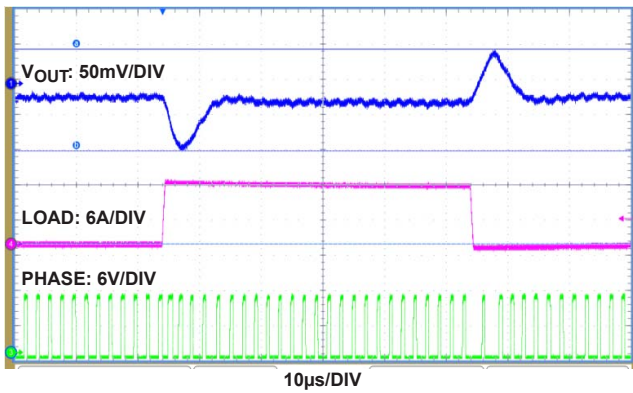

FIGURE 23. STEP RESPONSE AT PWM MODE, $V_{OUT} = 3.3V$, $f_{SW} = 500kHz$, LOAD: 0.25A TO 10.25A AT 25A/ μs)

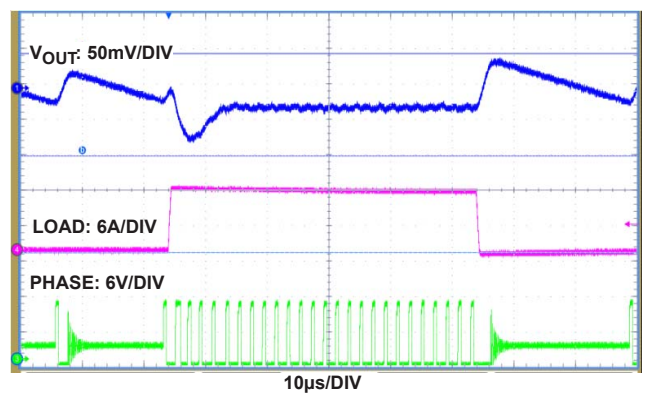

FIGURE 24. STEP RESPONSE AT PFM ENABLED MODE, $V_{OUT} = 3.3V$, $f_{SW} = 500kHz$, LOAD: 0.25A TO 10.25A AT 25A/ μs)

Performance Data (Continued)

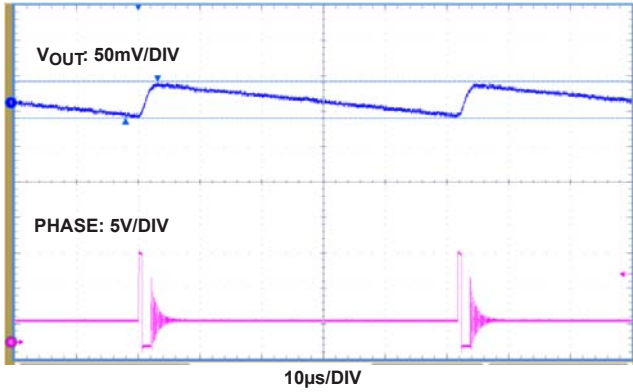

FIGURE 25. V_{OUT} RIPPLE IN PFM MODE ($V_{OUT} = 3.3V$, $f_{SW} = 500kHz$, $LOAD = 0A$)

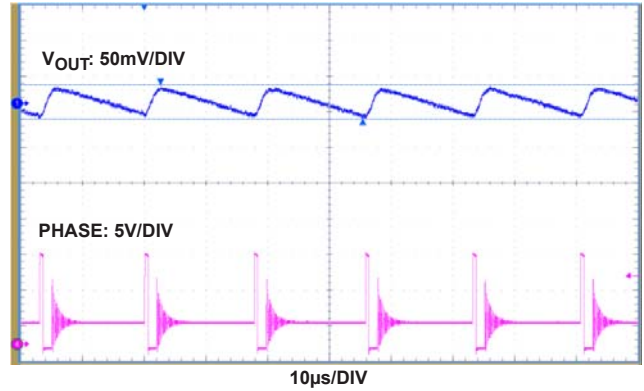

TABLE 4. V_{OUT} RIPPLE IN PFM MODE ($V_{OUT} = 3.3V$, $f_{SW} = 500kHz$, $LOAD = 0.25A$)

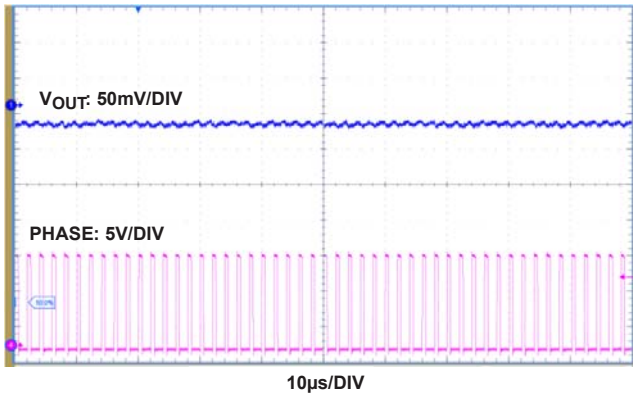

FIGURE 26. V_{OUT} RIPPLE IN PFM MODE ($V_{OUT} = 3.3V$, $f_{SW} = 500kHz$, $LOAD = 5A$)

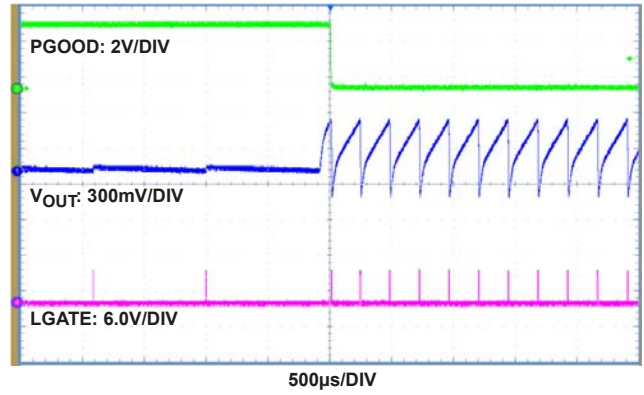

FIGURE 27. OVERVOLTAGE PROTECTION

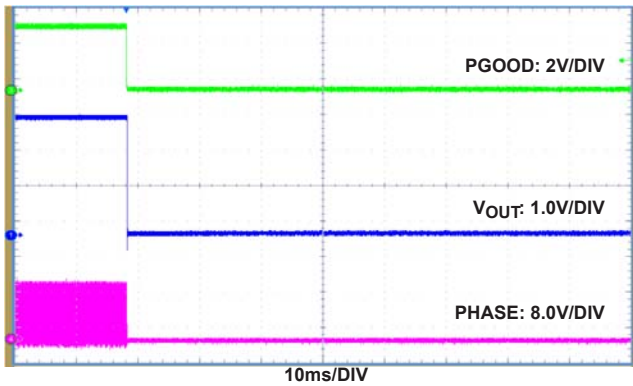

FIGURE 28. OVERCURRENT AND SHORT-CIRCUIT PROTECTION IN LATCH MODE

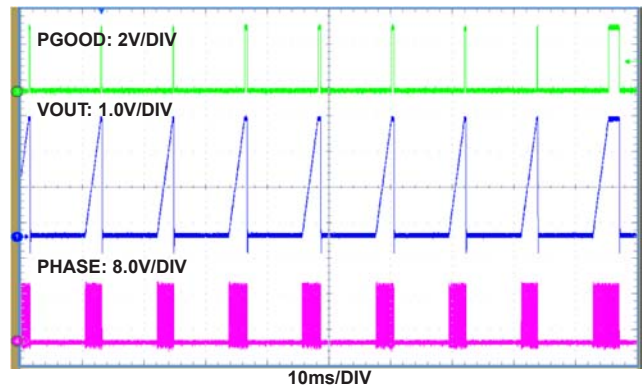

FIGURE 29. OVERCURRENT AND SHORT-CIRCUIT PROTECTION IN RETRY MODE

Performance Data (Continued)

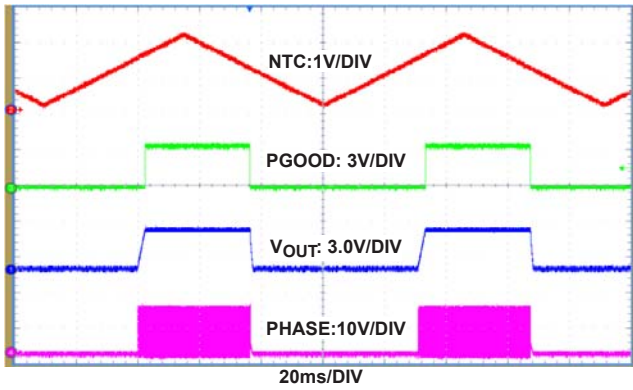
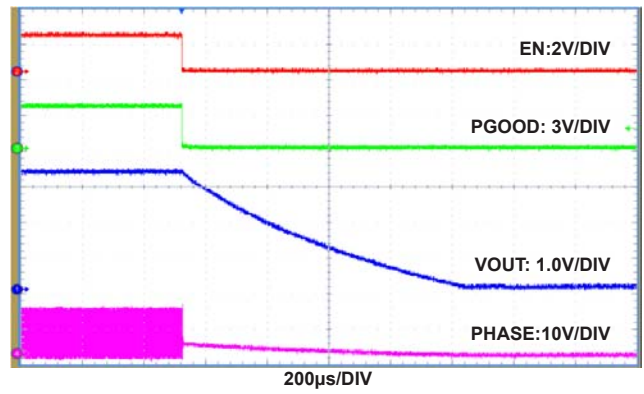
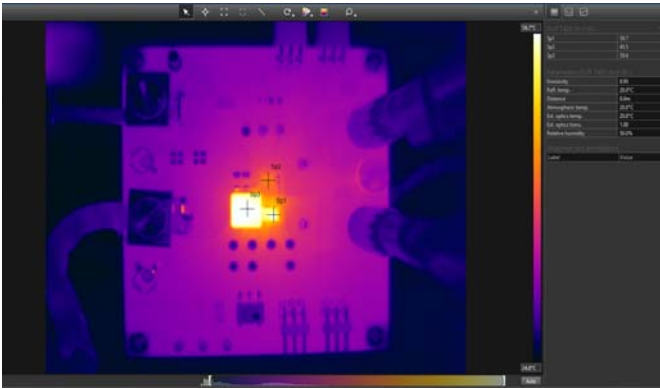

FIGURE 30. OVER-TEMPERATURE PROTECTION AT 1A LOAD



**FIGURE 31. POWER-DOWN AT $V_{OUT} = 3.3V$, 1A LOAD
(CH1-VOUT, CH2-EN, CH3-PGOOD, CH4-PHASE)**



**FIGURE 32. THERMAL IMAGE OF DEMO BOARD AT 16A LOAD
(ISL99125B (Sp1): 59.7 °C; INDUCTOR (Sp3): 59.6 °C;
ISL68201 (Sp2): 45.5 °C; AMBIENT: 20 °C; STILL AIR)**

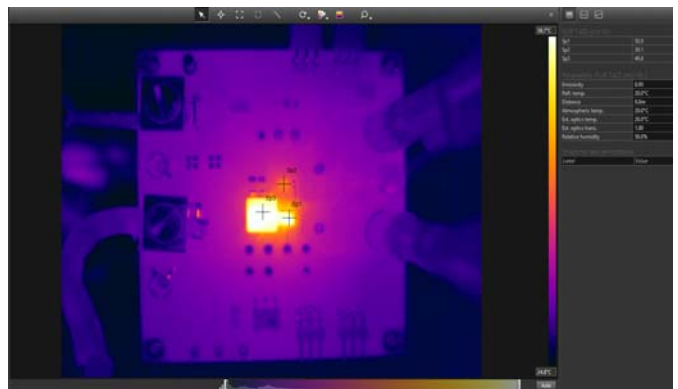

**FIGURE 33. THERMAL IMAGE OF DEMO BOARD AT 16A LOAD
(ISL99125B (Sp1): 50.9 °C; INDUCTOR (Sp3): 49.8 °C;
ISL68201 (Sp2): 39.1 °C; AMBIENT: 20 °C; 400 LFM)**

ISL68201-99125DEMO1Z Board Layout

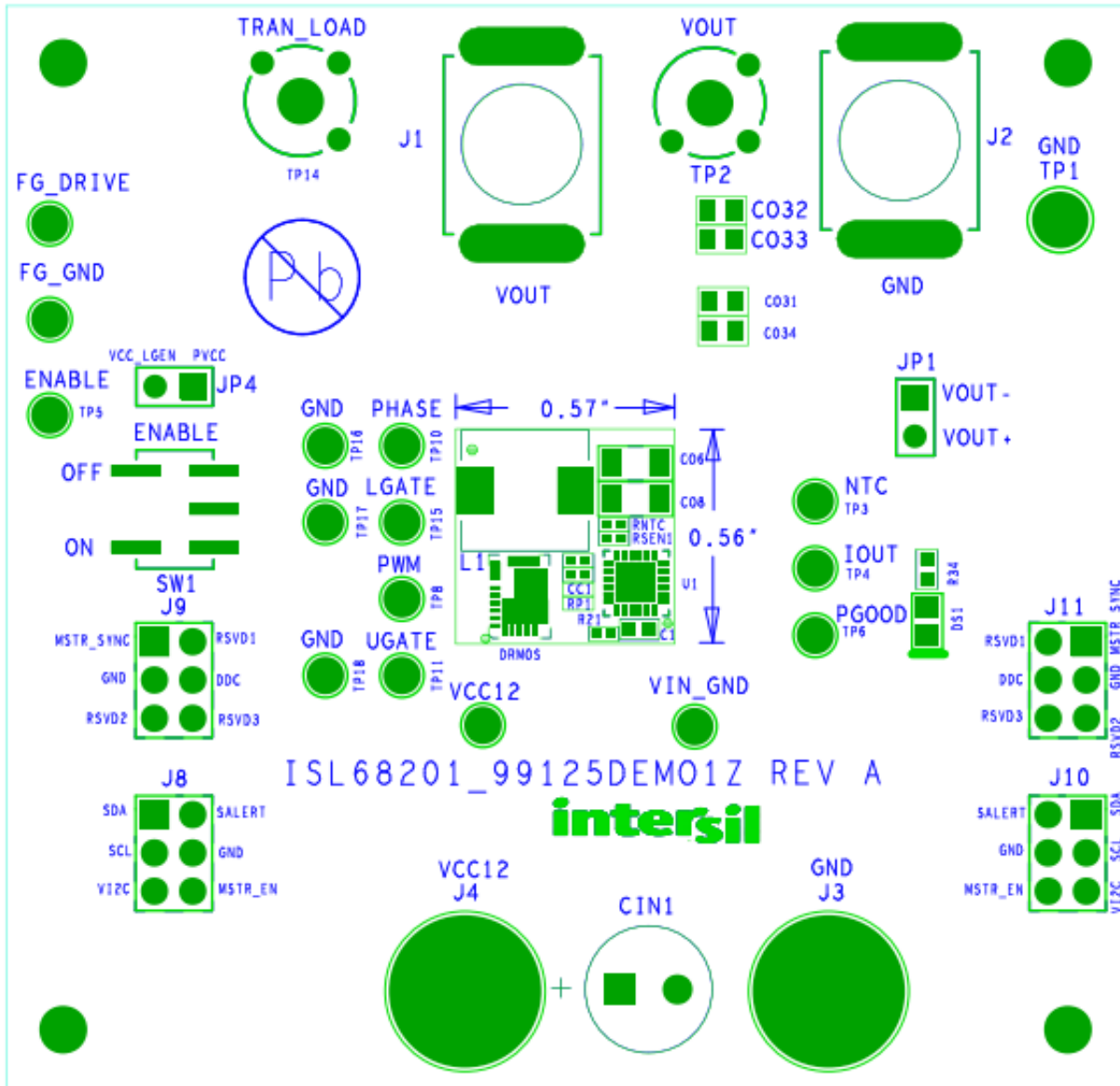

FIGURE 34. PCB - TOP ASSEMBLY

ISL68201-99125DEMO1Z Board Layout (Continued)

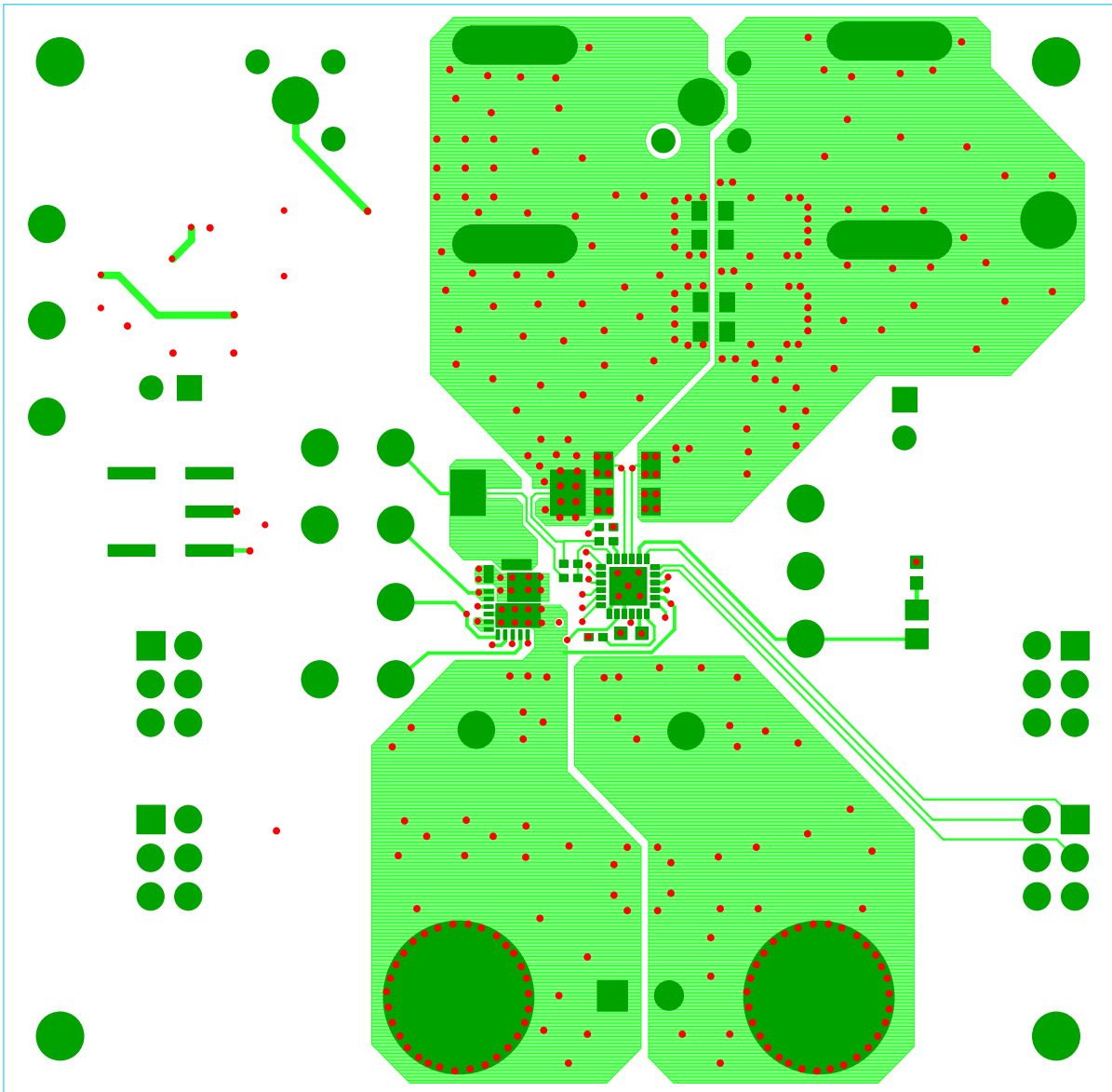

FIGURE 35. PCB - TOP LAYER (TOP VIEW)

ISL68201-99125DEMO1Z Board Layout (Continued)

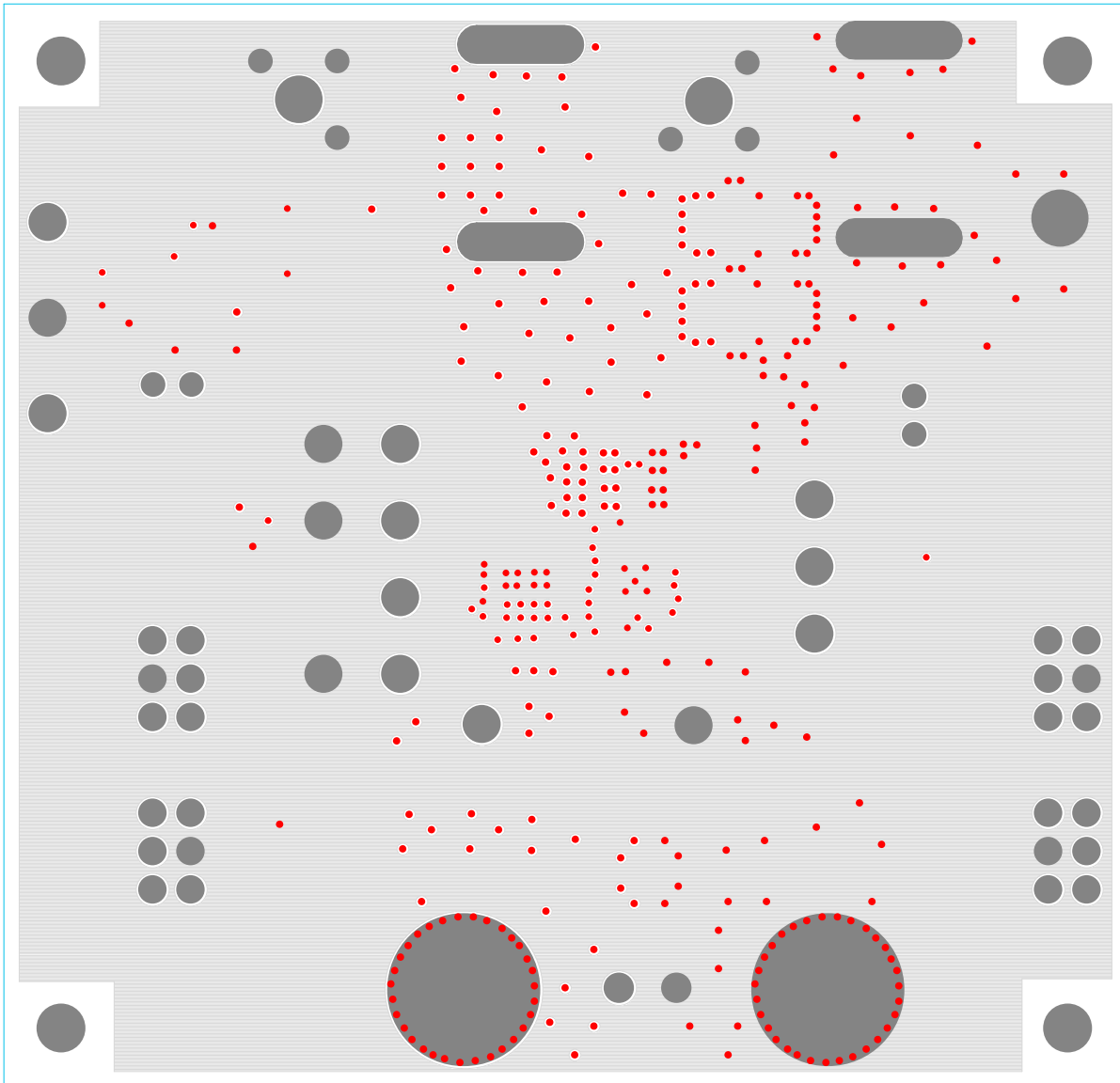

FIGURE 36. PCB - INNER LAYER 2 (TOP VIEW)

ISL68201-99125DEMO1Z Board Layout (Continued)

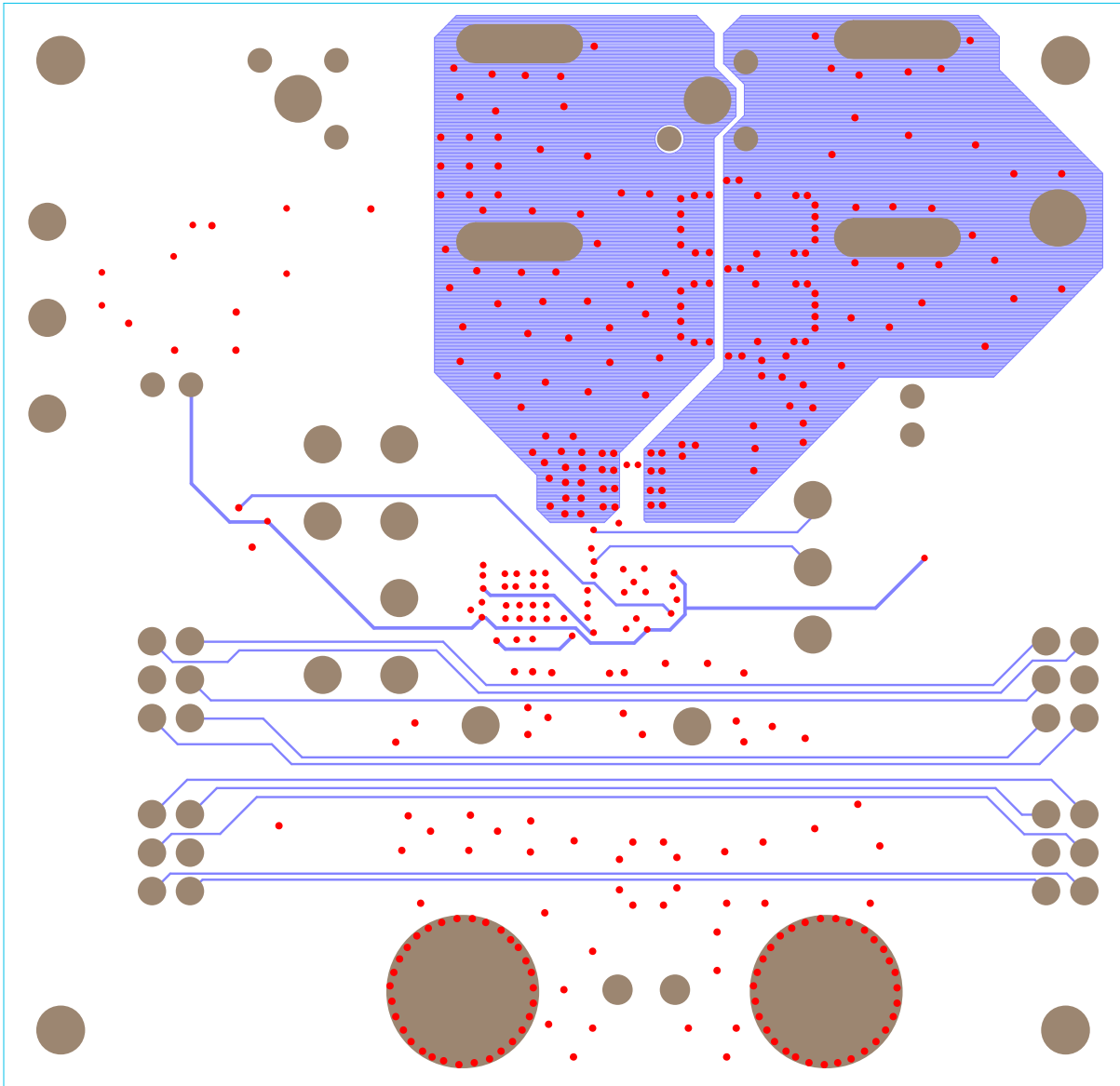

FIGURE 37. PCB - INNER LAYER 3 (TOP VIEW)

ISL68201-99125DEMO1Z Board Layout (Continued)

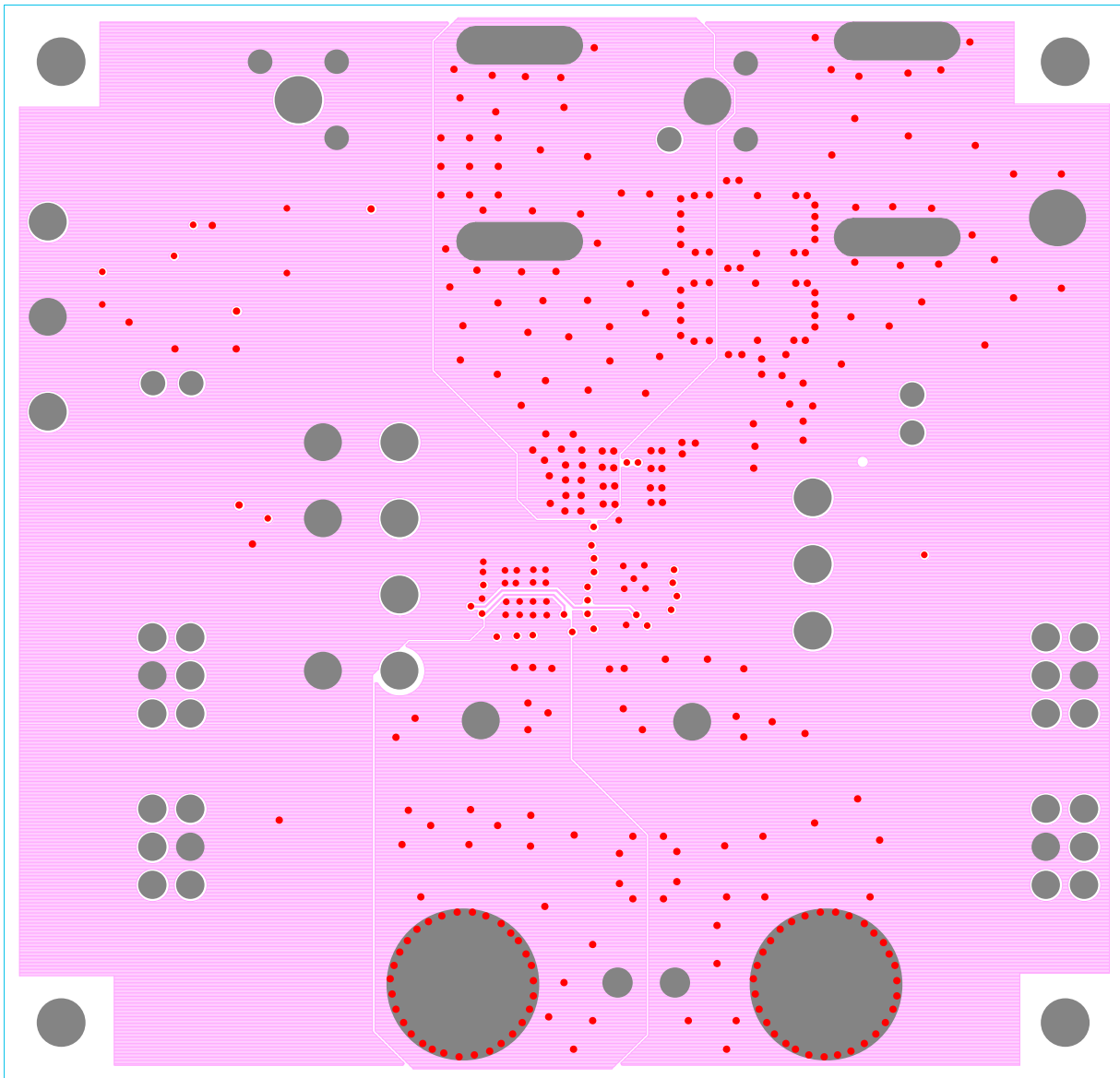

FIGURE 38. PCB - INNER LAYER 4 (TOP VIEW)

ISL68201-99125DEMO1Z Board Layout (Continued)

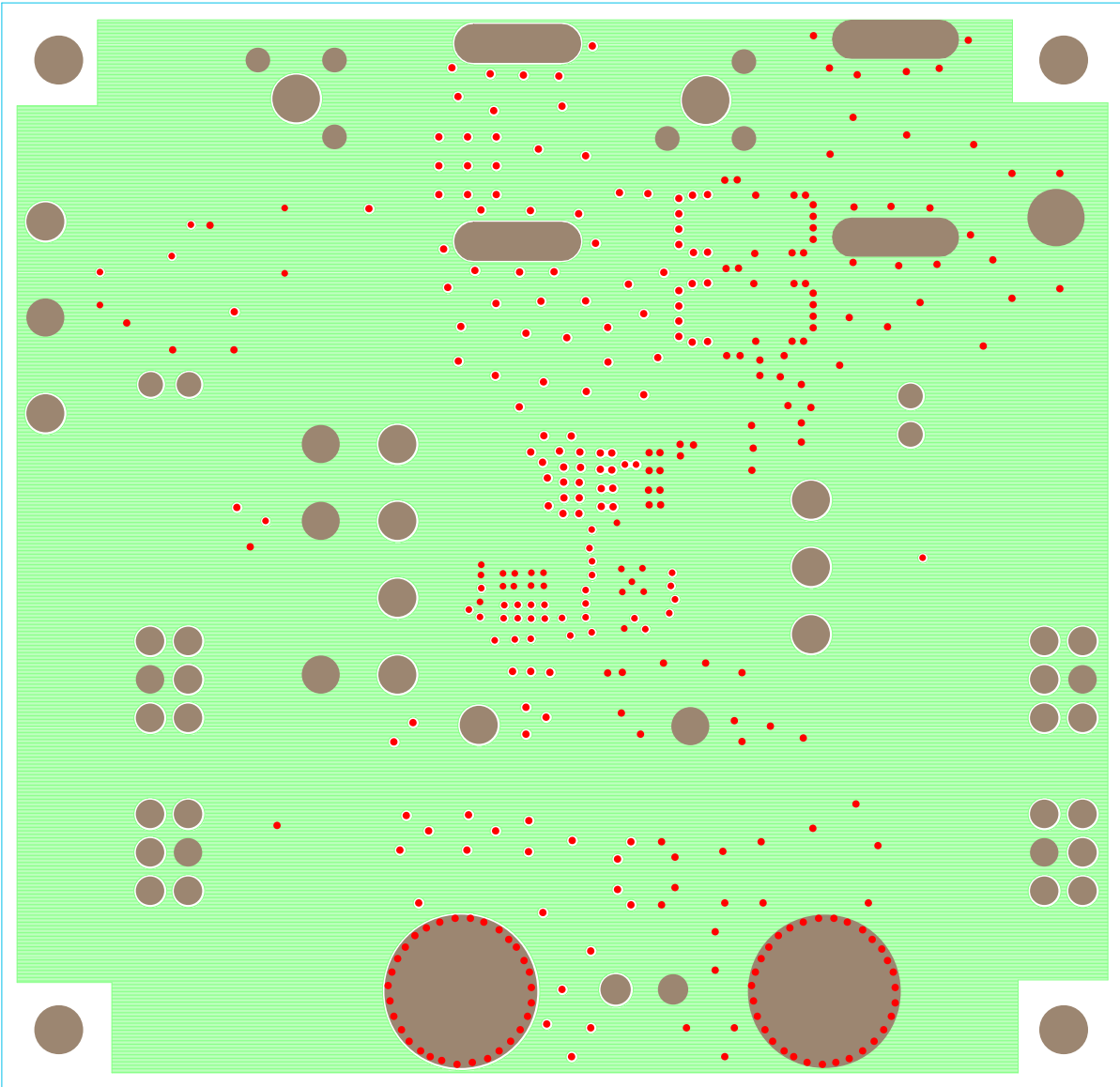

FIGURE 39. PCB - INNER LAYER 5 (TOP VIEW)

ISL68201-99125DEMO1Z Board Layout (Continued)

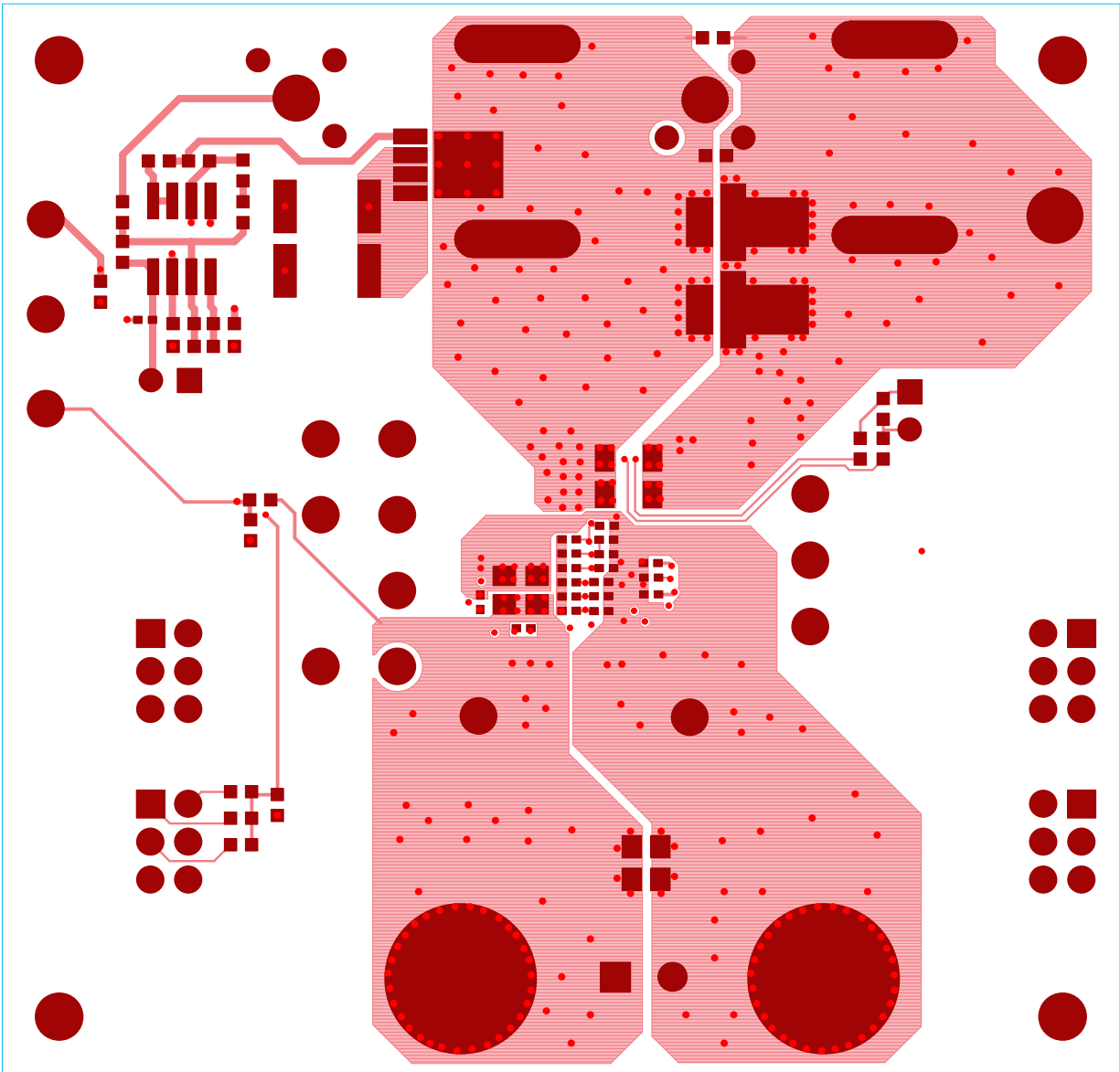

FIGURE 40. PCB - BOTTOM LAYER (TOP VIEW)

ISL68201-99125DEMO1Z Board Layout (Continued)

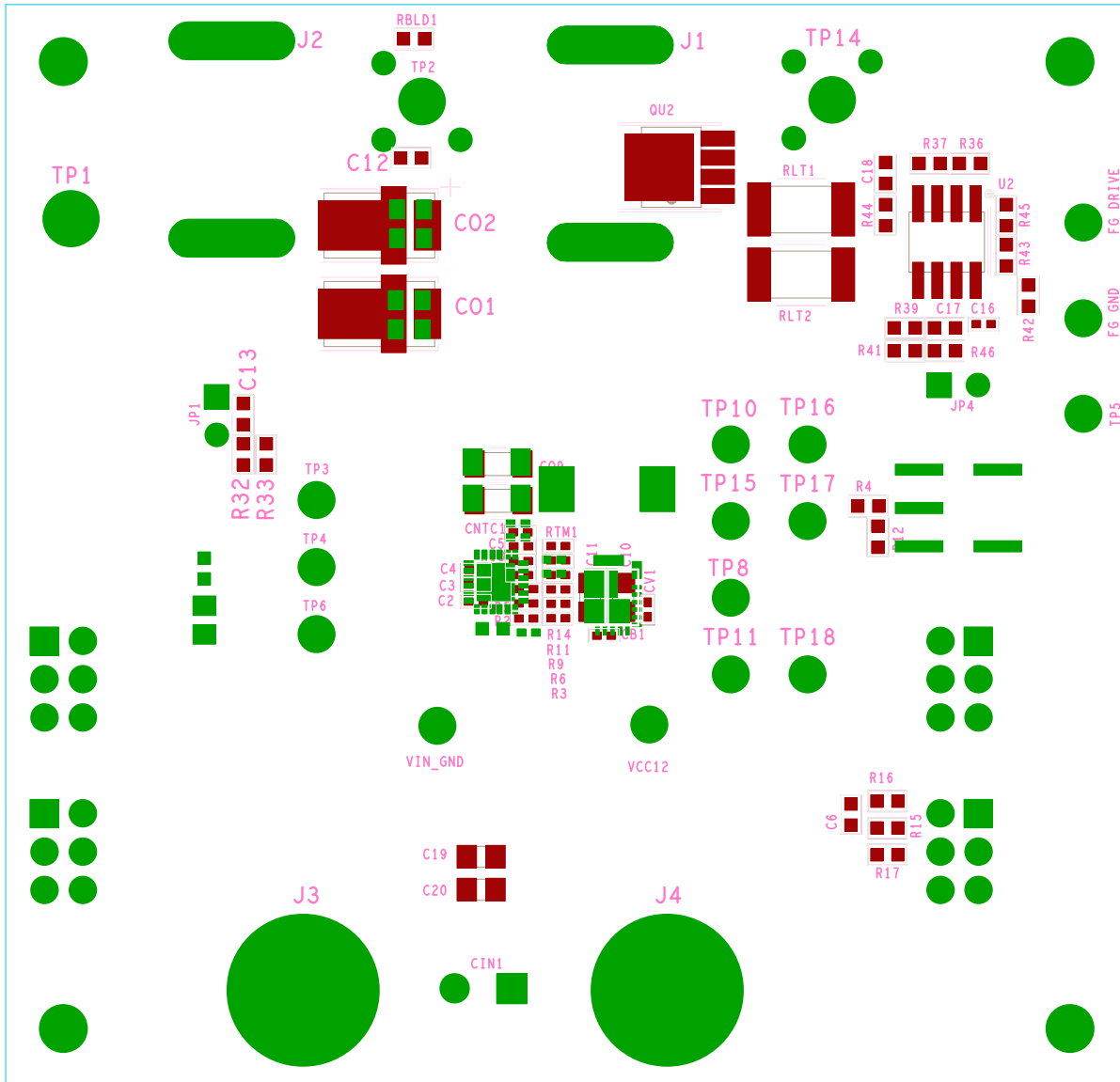

FIGURE 41. PCB - BOTTOM ASSEMBLY (BOTTOM VIEW)

© Copyright Intersil Americas LLC 2016-2017. All Rights Reserved.
 All trademarks and registered trademarks are the property of their respective owners.

Intersil Corporation reserves the right to make changes in circuit design, software and/or specifications at any time without notice. Accordingly, the reader is cautioned to verify that the document is current before proceeding.

For information regarding Intersil Corporation and its products, see www.intersil.com