

ISL70002SEHDEMO1Z

User's Manual: Demonstration Board

High Reliability

ISL70002SEHDEMO1Z

Demonstration Board

UG166
Rev.0.00
May 24, 2018

1. Overview

The ISL70002SEHDEMO1Z demonstration board shows the [ISL70002SEH](#) in a dual current sharing configuration to 38A of output current.

1.1 Key Features

- Ease of use
- Critical monitor points
- Commercial version of NASA outgassing compliant power inductor

1.2 Specifications

- $V_{IN} = 3V$ to $5.5V$
- $V_{OUT} = 0.95V$
- Minimum current limit = 43A
- Switching frequency = 500kHz

1.3 Ordering Information

Part Number	Description
ISL70002SEHDEMO1Z	ISL70002SEH dual high current demonstration board

1.4 Related Literature

For a full list of related documents, visit our website

- [ISL70002SEH](#) product page

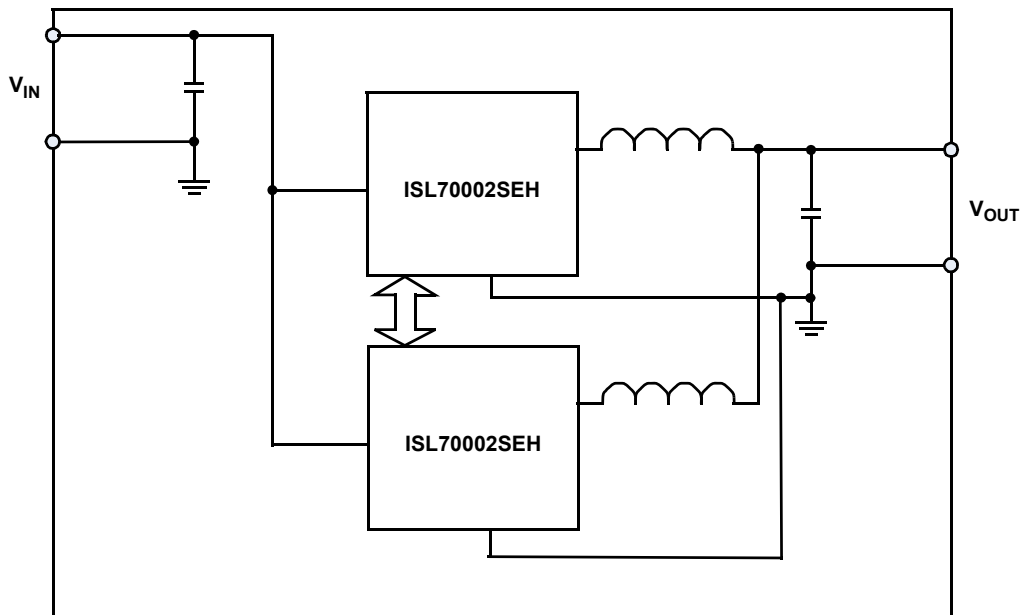

Figure 1. ISL70002SEHDEMO1Z Block Diagram

2. Functional Description

The ISL70002SEHDEMO1Z provides a 0.95V output from a 3V to 5.5V input with an output current load up to 38A. The two ISL70002SEH devices on board are in a current sharing configuration. They are set to enable upon V_{IN} being applied and PORSEL pulled low. Switching typically starts at a V_{IN} of 2.8V.

2.1 Operating Range

Although rated across the full military ambient temperature range, factors that influence the operational envelope include input and output voltages, switching frequency, output current, and die temperature.

The ISL70002SEHDEMO1Z is default configured to provide an output voltage of 0.95V, with a 500kHz switching frequency. To change the output voltage, R_{20} in the output voltage divider has to be changed. As guidance, the output voltage range is adjustable from ~0.65V to ~80% of the input voltage. These are not hard stops on the operating envelope as the constraint is set by the minimum on and off time and influenced by temperature and current loading.

2.2 Quick Start Guide

The ISL70002SEHDEMO1Z is simple to use with a minimum of steps listed below to observe operation:

- (1) Connect a suitable power supply to the VIN connector, set the supply between 3V and 5.5V. Account for voltage drop to ensure adequate bias is applied at full load. Test points are provided to measure closer to the IC PVIN, inductor output and ground pins.
- (2) Connect an electronic or resistive load to the output. Configure the output current loading to not exceed 40A.
- (3) Turn-on the input voltage, confirm the output voltage is 0.95V
- (4) Three probe jacks are provided to observe the two LX nodes switching out of sync with each other, and for the output voltage.

The information displayed in the [Typical Performance Curves](#) starting on page 11 was gathered on the ISL70002SEHDEMO1Z. Modifications were made for some of the testing and thus cannot be replicated without additional effort. Modifications were limited to the addition of circuit access points and or component changes.

The case temperature efficiency data in [Figures 15, 16, and 31](#) through [43](#) was taken with the board immersed in a turbulent liquid environment to control the package temperature. Efficiency curves are at the noted case temperatures (T_C).

The inductors used are the Coilcraft XAL1580-102MEB, a commercial version of the AE619PYA102MSZ (1 μ H, 1m Ω , 73A), a NASA outgassing compliant power inductor. Oversized current is advisable for this application and it is a readily available standard product.

3. PCB Layout Guidelines

Printed Circuit Board (PCB) layout is very important in high frequency switching converter design. The resulting current transitions from one power device to another can cause voltage spikes across the interconnecting impedances and parasitic circuit elements. These voltage spikes can degrade efficiency, radiate noise into the circuit, and lead to device overvoltage stress. Careful component layout and PCB design minimizes these voltage spikes. The following guidelines can mitigate those effects:

- Use an eight layer PCB with 2oz (70 μ m) copper on all layers.
- Two layers should be dedicated for ground plane.
- Top and bottom layers should be used primarily for signals, but can also be used to increase the V_{IN} , V_{OUT} , and ground planes as required.
- Connect all AGND, DGND, and PGNDx pins directly to the ground plane. Connect all PVINx pins directly to the VIN portion of the power plane.
- Locate ceramic bypass capacitors as close as possible to the switcher. Prioritize the placement of the bypass capacitors on the pins of in the order shown: PVINx, REF, AVDD, DVDD, SS, EN, PGOOD.
- Locate the output voltage resistive divider and the compensation as close as possible to the FB and VERR pins of the IC. The top leg of the divider should connect directly to the load and the bottom leg of the resistive divider should connect directly to AGND. The junction of the resistive divider should connect directly to the FB pin.
- Use a small island of copper to connect the LXx pins of U1 to the inductor, L1, to minimize the routing capacitance that degrades efficiency. Separate the island from ground and power planes as much as is reasonably possible with inner layer voiding and shape spacing.
- Keep all signal traces as short as possible.
- Optimize load regulation by reducing noise from the power and digital grounds into the analog ground by splitting ground into three planes; analog, digital, and power. Bypass or ground pins accordingly to their design preferred ground plane. Independently tie each of the analog and digital grounds to power ground through a single trace in a low noise area of the layout.

3.1 Heatsink Mounting Guidelines

The R64.C package has a heatsink mounted on the underside of the package and is the recommended package for the high current (>12A per IC) application. Follow these JESD-51x series guidelines to mount the package:

- Place a thermal land on the PCB under the heatsink.
- The land should be approximately 1mm larger per side than the 10.16x10.16mm heatsink.
- Place an array of thermal vias below the thermal land.
- Via array size: $7 \times 4 = 49$ thermal vias placed under each device.
- Vias should drop to and contact as much metal area on other layers as feasible to provide the best thermal path.

3.2 Schottky Diode Clamp and RC Snubber

Place a Schottky diode clamp at the LX node to GND as close as possible to the IC when the output current is 18A or greater per IC. A diode rated for an average forward current of 3A at the maximum operating temperature is adequate.

The diode, by shunting current at the switching transient edges, reduces the Si die temperature approximately 22% at an output current level of 18A.

It is imperative that adequate thermal relief in the hardware design is implemented, because at an output current level of 22A the Si temperature is >135°C with the diode clamp in place at ambient room temperature.

A small series R-C snubber connected from the LXx pins to the PGNDx pins may be used to damp high-frequency ringing on the LXx pins.

3.3 ISL70002SEHDEMO1Z Demonstration Board

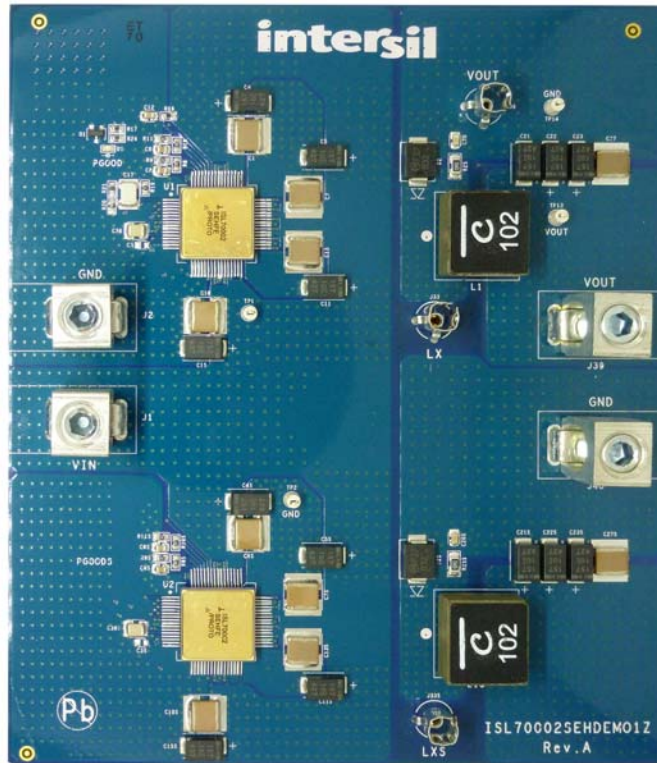

Figure 2. ISL70002SEHDEMO1Z Demonstration Board (Top)

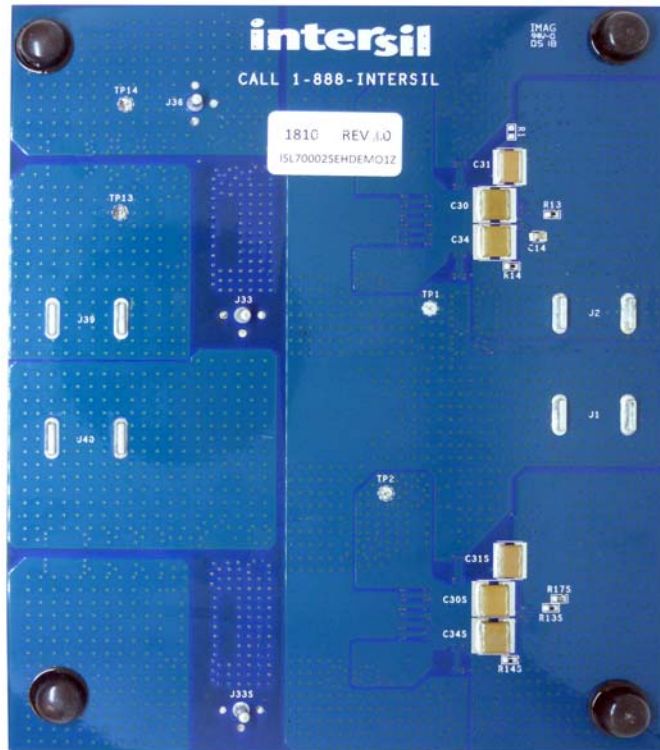

Figure 3. ISL70002SEHDEMO1Z Demonstration Board (Bottom)

3.4 ISL70002SEHDEMO1Z Circuit Schematic

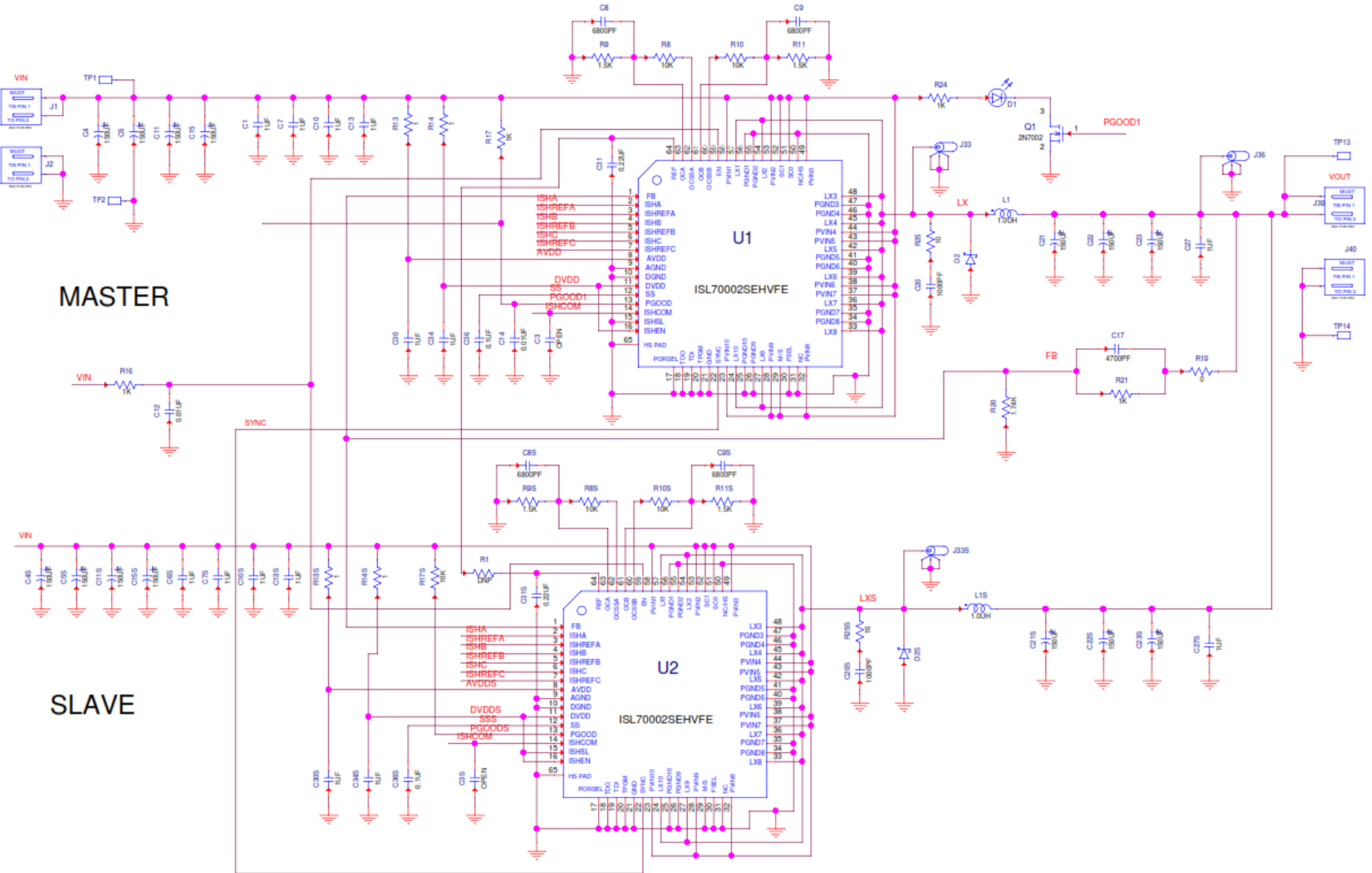

Figure 4. ISL70002SEHDEMO1Z Schematic

3.5 Bill of Materials

Qty	Reference Designator	Description	Manufacturer	Manufacturer Part Number
2	U1, U2	18A SYNCHRONOUS BUCK REGULATOR w/HeatSink	Renesas	ISL70002SEHVFE
2	L1, L1S	1 μ H, 1m Ω , 73A, commercial version of NASA Outgassing Compliant Power Inductor	Coilcraft	XAL1580-102MEB
2	D2, D2S	3A 20V SCHOTTKY POWER RECTIFIER	ON-SEMI	MBRS320T3
2	C20, C20S	Ceramic Chip Cap	KEMET	C0805C102K2RAC
2	C12, C14	Ceramic Chip Cap	KEMET	C0805C103K2RAC
4	C8, C9, C8S, C9S	Multilayer Cap	KEMET	C0805C682K2RAC
2	C36, C36S	Ceramic Chip Cap	KEMET	C1210C104K2RAC
1	C17	Multilayer Cap	KEMET	C1812C472F2GAC
2	C31, C31S	Ceramic Chip Cap	KEMET	C1825C224K2RAC
14	C1, C7, C10, C13, C27, C30, C34, C6S, C7S, C10S, C13S, C27S, C30S, C34S	Multilayer Cap	KEMET	C2225C105K2RAC
2	C3, C3S	Multilayer Cap	GENERIC	H1045-OPEN
5	R8, R10, R8S, R10S, R17S	Metal Film Chip Resistor	GENERIC	H2505-01002-1/16WR1
1	R19	Thick Film Chip Resistor	GENERIC	H2511-00R00-1/16W1
1	R24	Thick Film Chip Resistor	GENERIC	H2511-01001-1/16W1
1	R20	Thick Film Chip Resistor	GENERIC	H2511-01741-1/16W1
1	D1	AllnGaP Green	LITEON	LTST-C190KGKT
1	R16	Metal Film Chip Resistor	ROHM	MCR03EZPFX1001
2	R17, R21	Thick Film Chip Resistor	State of the Art	S0603CA1001BEB
4	R9, R11, R9S, R11S	25ppm Thin Film Chip Resistor	State of the Art	S0603CA1501BEZ
4	R13, R14, R13S, R14S	100ppm Thick Film Chip Resistor	State of the Art	S0603CPZ1R00F10
2	R25, R25S	100ppm Thick Film Chip Resistor	State of the Art	S1206CPZ10R0F10
14	C4, C5, C11, C15, C21-C23, C4S, C5S, C11S, C15S, C21S-C23S	High Capacitance Ultra-Low ESR Tantalum SMD Cap	KEMET	T530D157M010ATE006
1	R1	Metal Film Chip Resistor (Do Not Populate)	GENERIC	H2505-DNP-DNP-R1
3	J33, J36, J33S	Scope Probe Test Point PCB Mount	TEKTRONIX	131-4353-00
1	Q1	N-Channel EMF Effect Transistor	FAIRCHILD	2N7002
4	TP1, TP2, TP13, TP14	Miniature White Test Point .100 Pad .040 Through hole	KEYSTONE	5002
4	J1, J2, J39, J40	Single - Hex Screw - .140in PCB depth Screw Down Large Wire Type Power Terminal	IHI Connectors	B2C-PCB-HEX

3.6 Board Layout

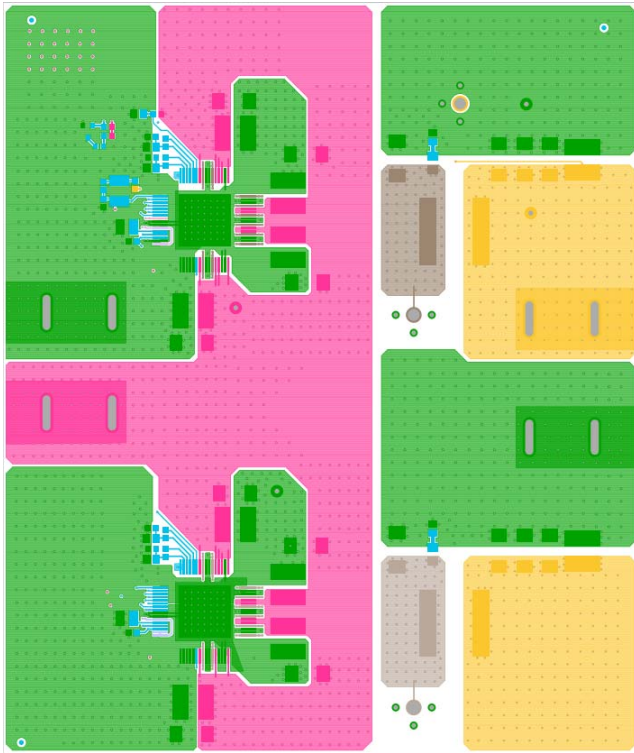

Figure 5. Top Layer

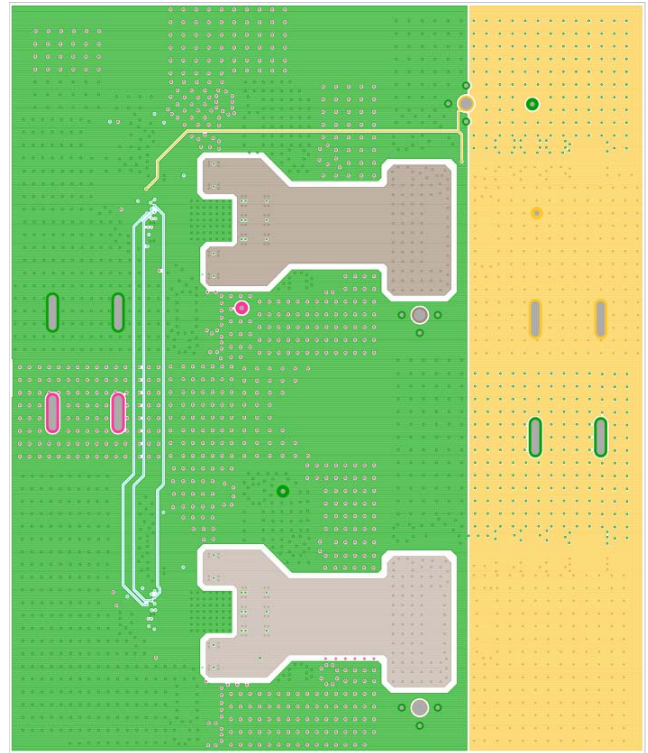

Figure 6. Layer 2

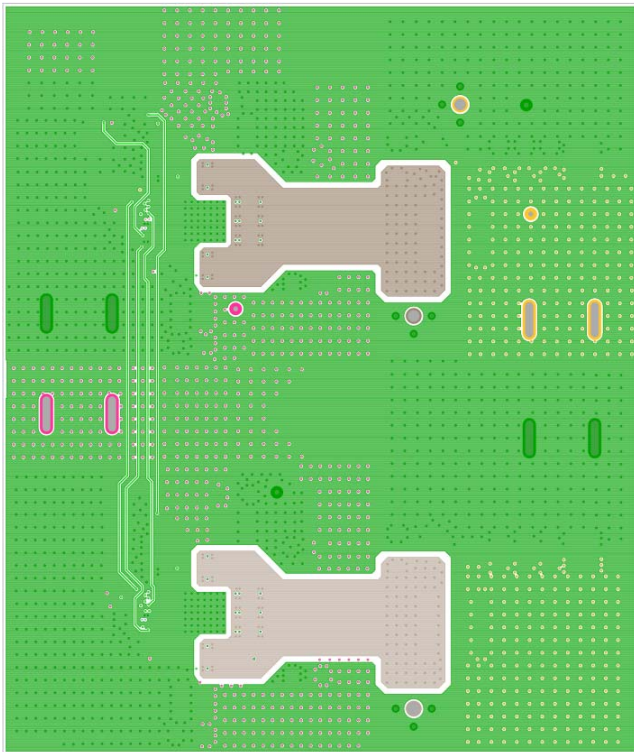

Figure 7. Layer 3

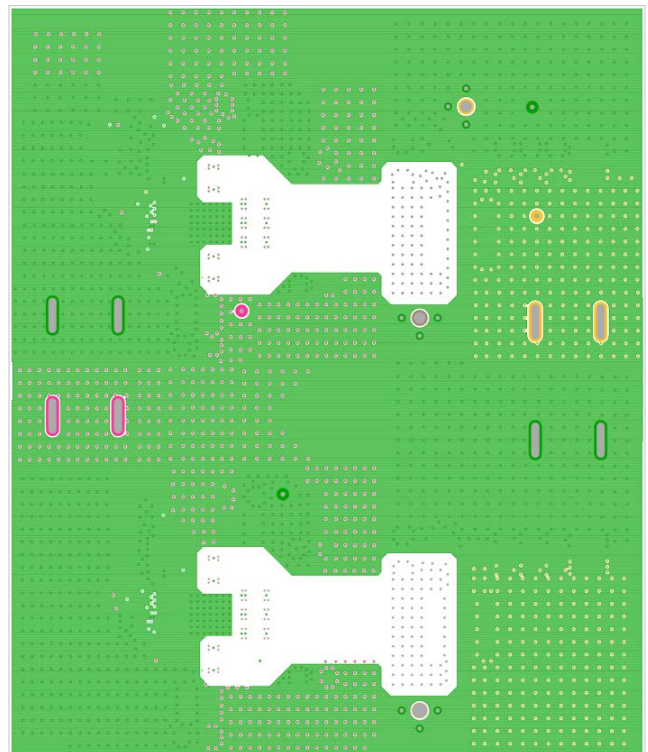

Figure 8. Layer 4

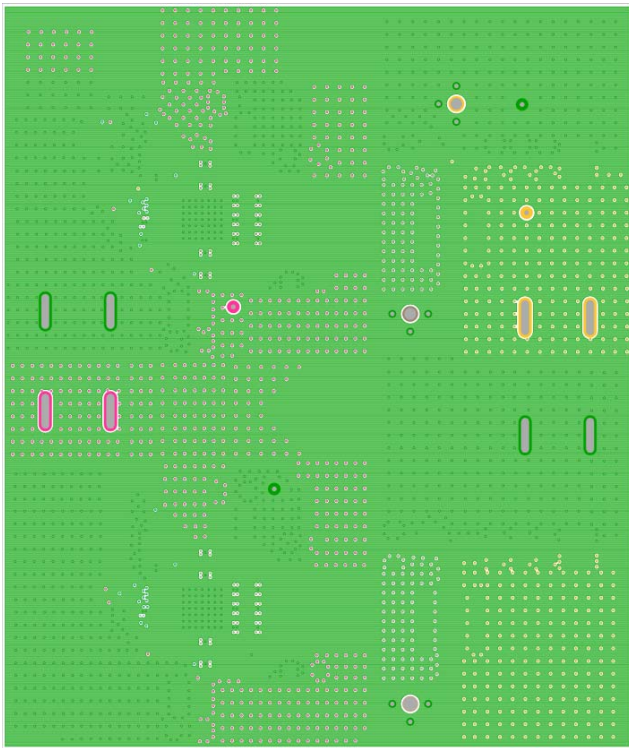

Figure 9. Layer 5

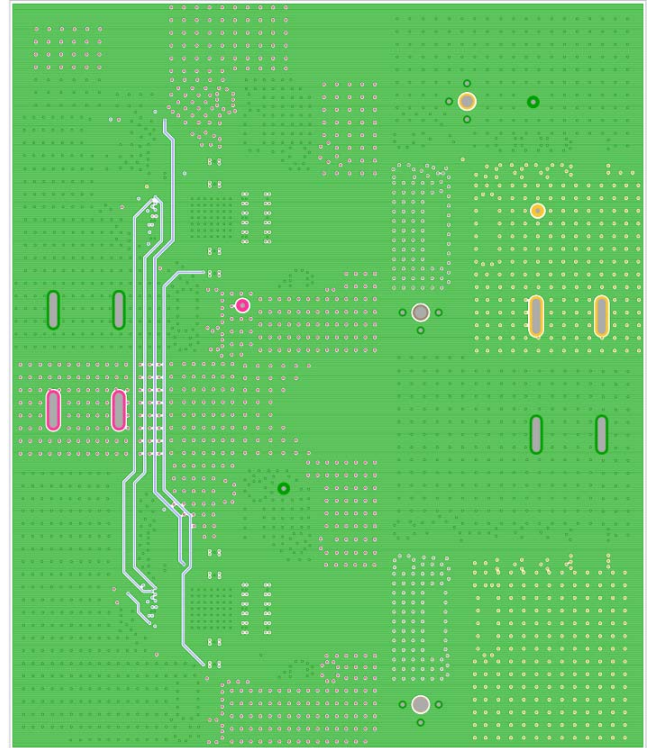

Figure 10. Layer 6

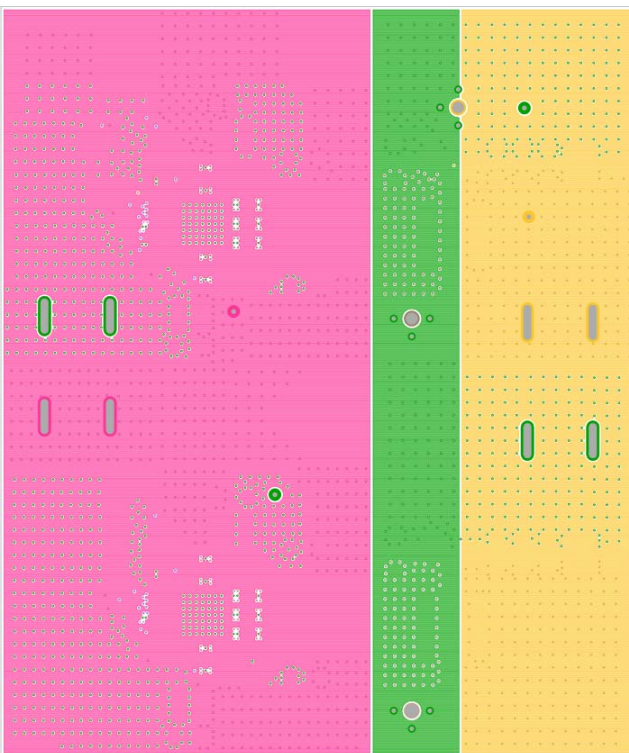

Figure 11. Layer 7

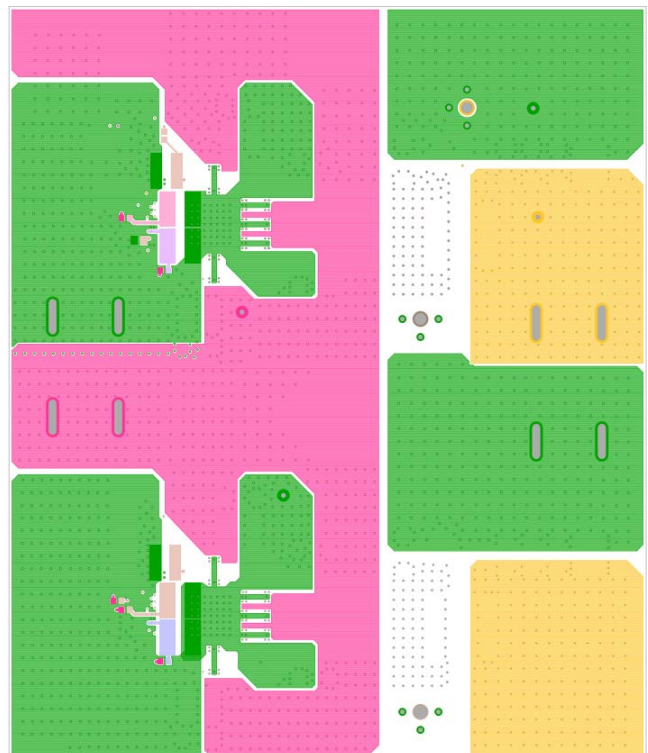

Figure 12. Bottom Layer

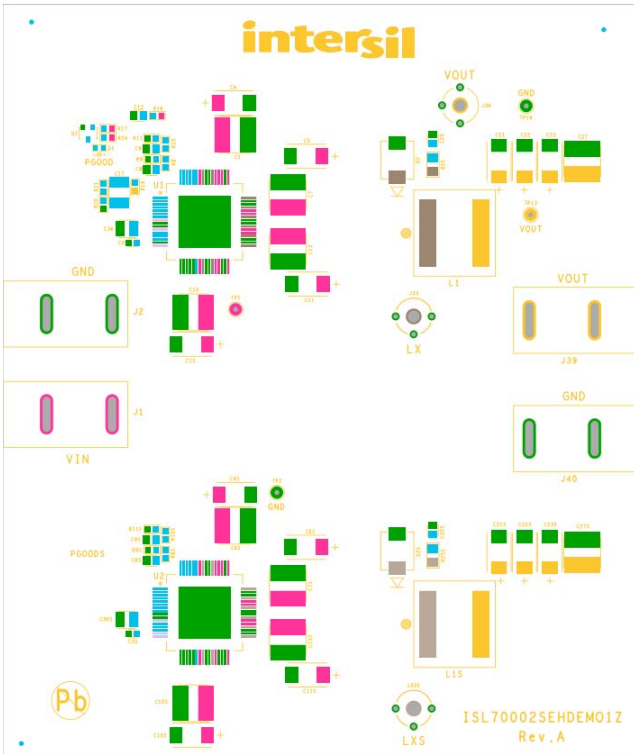

Figure 13. Top Silkscreen

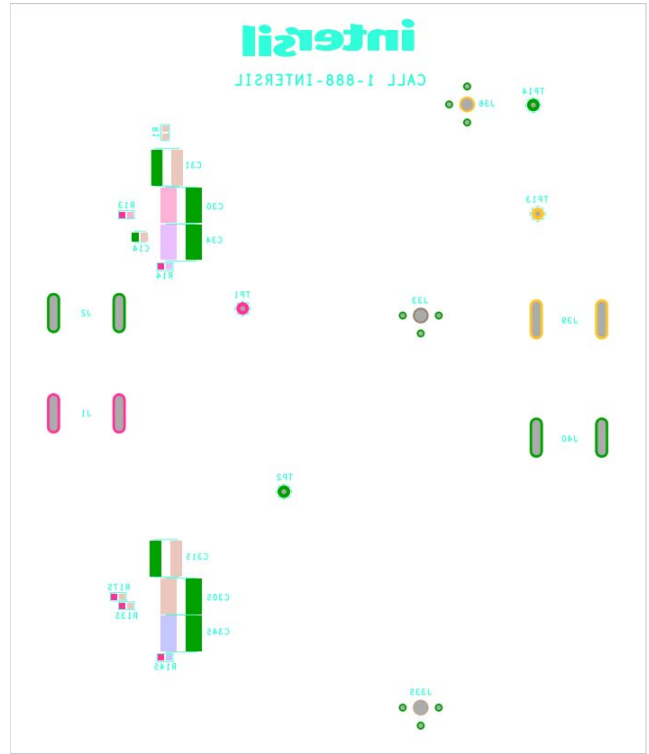

Figure 14. Bottom Silkscreen

4. Typical Performance Curves

Unless noted: $V_{IN} = 3.3V$, $V_{OUT} = 0.95V$, $f_{SW} = 500kHz$, $T_A = +25^\circ C$. Efficiency curves are at the noted case temperatures (T_C)

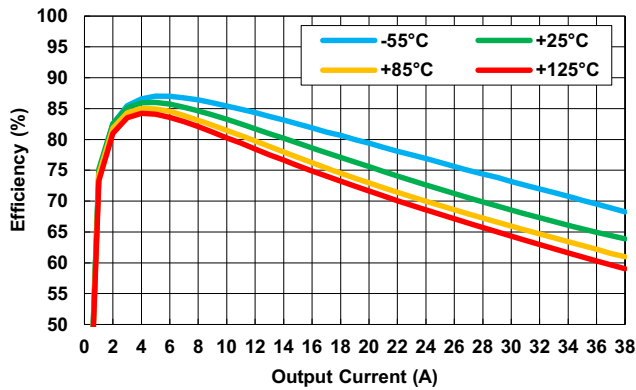

Figure 15. $V_{IN} = 3.3V$ Over-Temperature Efficiency

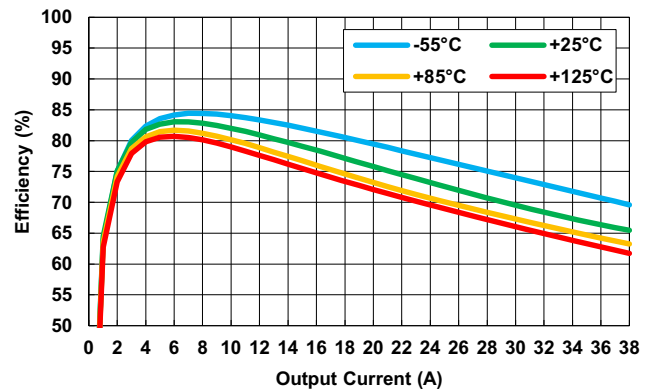

Figure 16. $V_{IN} = 5V$ Over-Temperature Efficiency

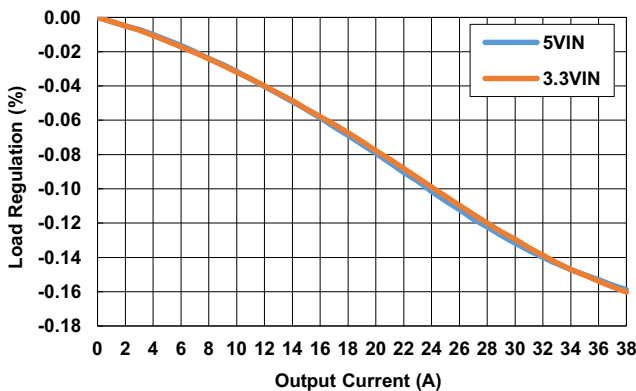

Figure 17. Load Regulation

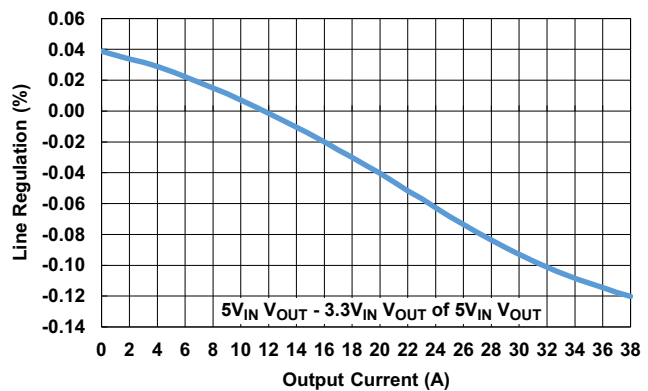

Figure 18. DC Line Regulation

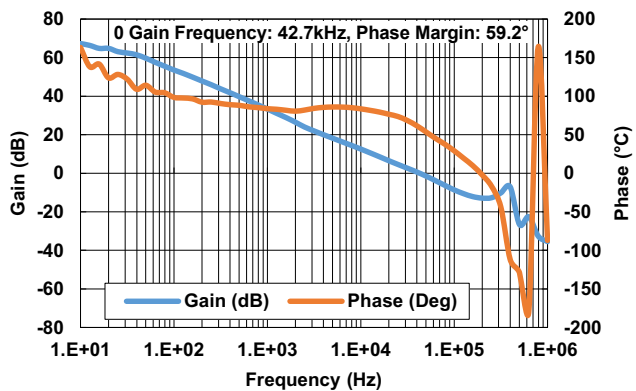

Figure 19. $3.3V_{IN}$ Gain/Phase Bode Plot

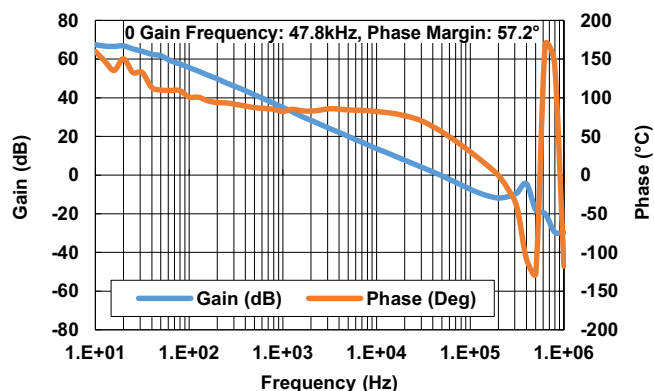

Figure 20. $5V_{IN}$ Gain/Phase Bode Plot

Unless noted: $V_{IN} = 3.3V$, $V_{OUT} = 0.95V$, $f_{SW} = 500kHz$, $T_A = +25^\circ C$. Efficiency curves are at the noted case temperatures (T_C) (Continued)

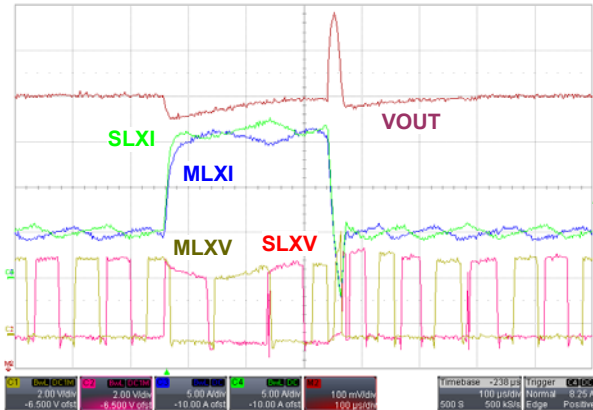

Figure 21. 3.3V_{IN} Output Voltage Regulation with 10A to 30A Transient

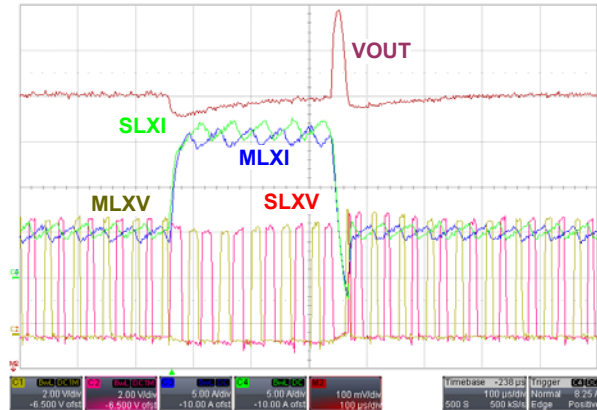

Figure 22. 5V_{IN} Output Voltage Regulation with 10A to 30A Transient

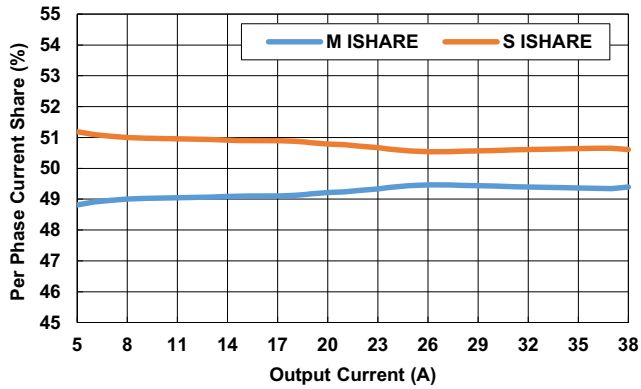

Figure 23. Current Share Over Output Current

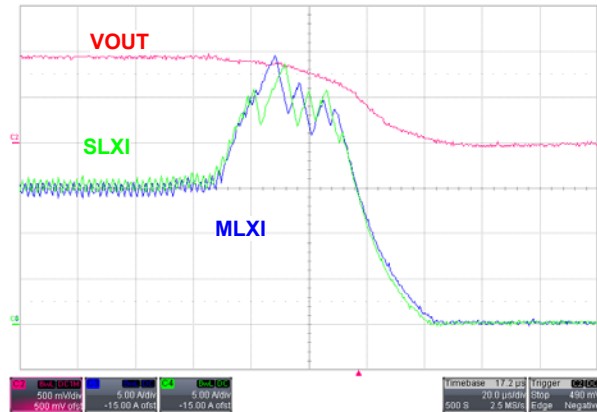

Figure 24. Overcurrent Response

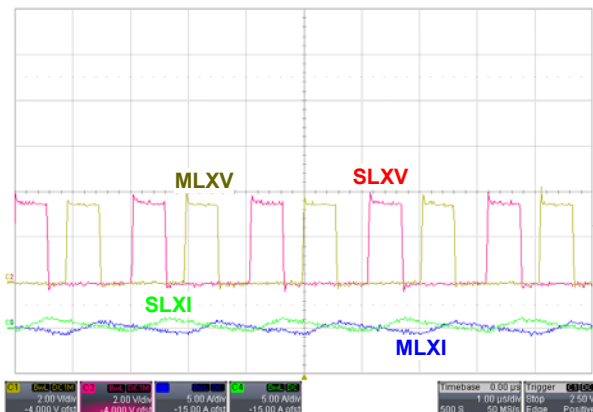

Figure 25. 0 Load LX and Current Ripple Detail

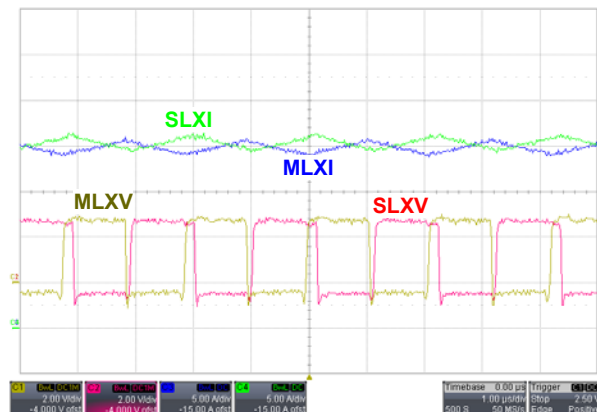

Figure 26. Full Load LX and Current Ripple Detail

Unless noted: $V_{IN} = 3.3V$, $V_{OUT} = 0.95V$, $f_{SW} = 500kHz$, $T_A = +25^\circ C$. Efficiency curves are at the noted case temperatures (T_C) (Continued)

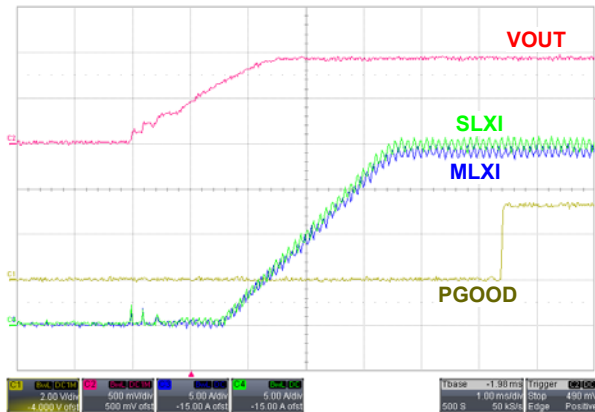

Figure 27. Current Share During Turn-on into 38A

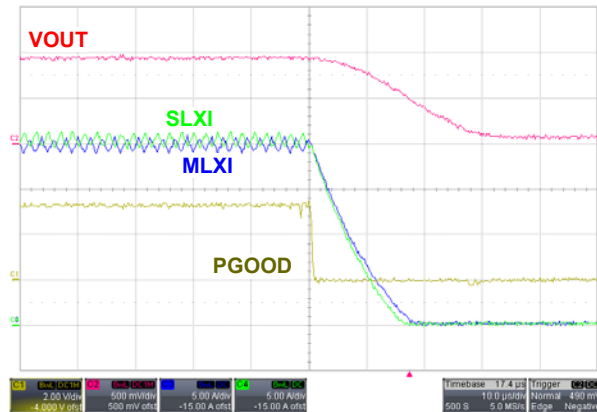

Figure 28. Current Share During Turn-off

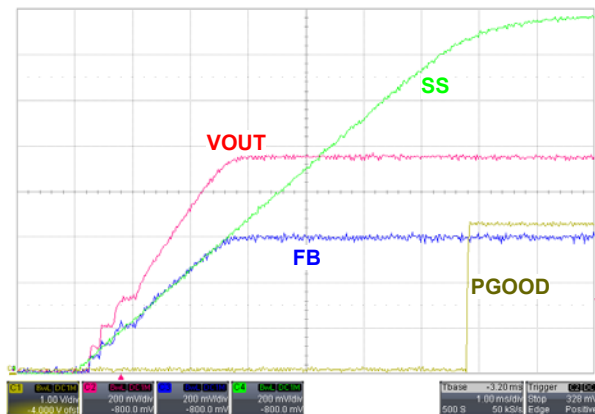

Figure 29. Turn-on Soft-Start Detail

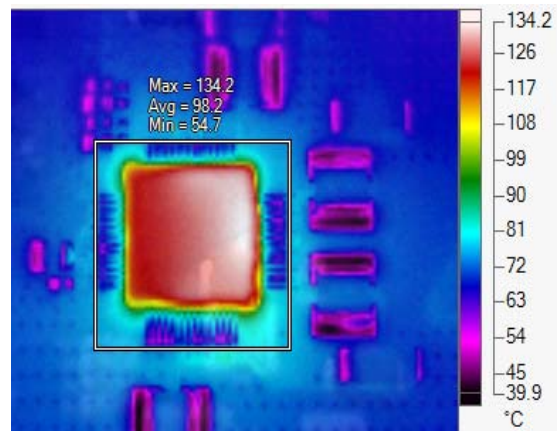

Figure 30. Case Temperature at 20A

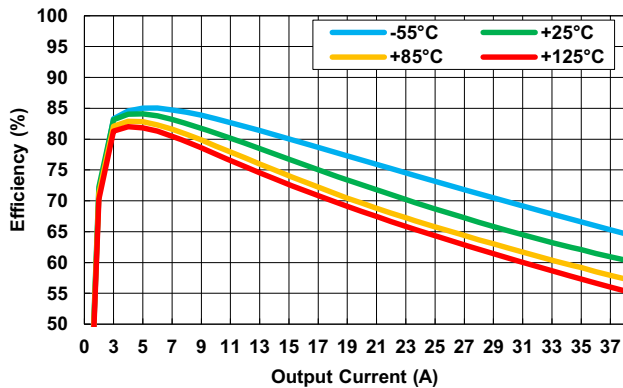

Figure 31. 3.3V to 0.8V Over-Temperature Efficiency

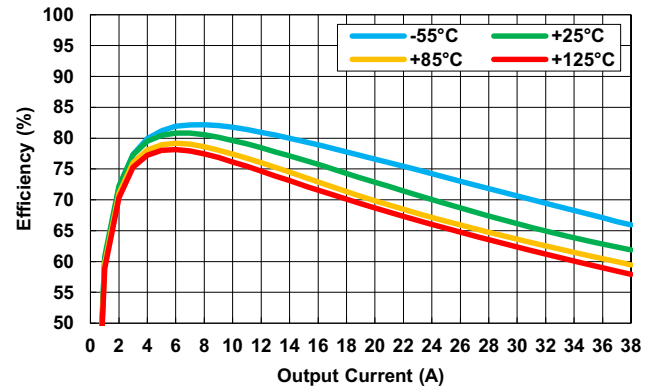

Figure 32. 5V to 0.8V Over-Temperature Efficiency

Unless noted: $V_{IN} = 3.3V$, $V_{OUT} = 0.95V$, $f_{SW} = 500kHz$, $T_A = +25^\circ C$. Efficiency curves are at the noted case temperatures (T_C) (Continued)

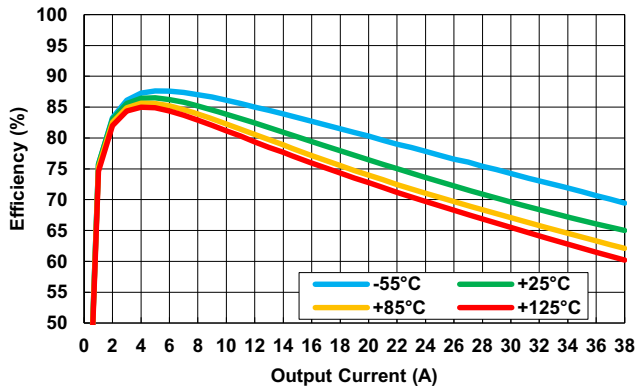

Figure 33. 3.3V to 1V Over-Temperature Efficiency

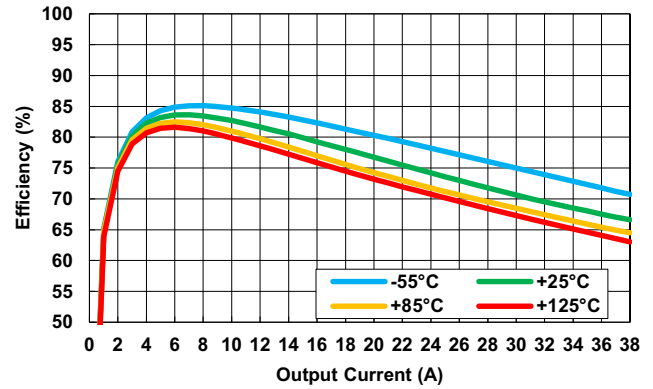

Figure 34. 5V to 1V Over-Temperature Efficiency

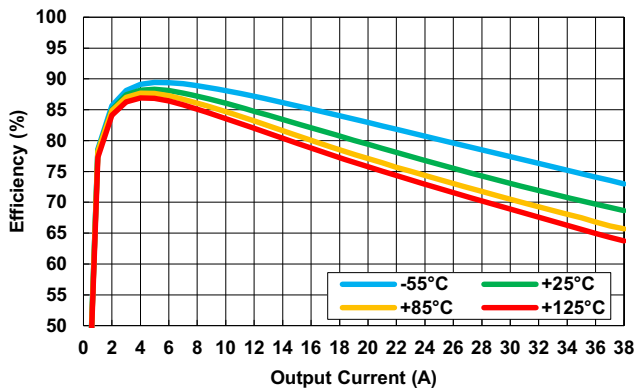

Figure 35. 3.3V to 1.2V Over-Temperature Efficiency

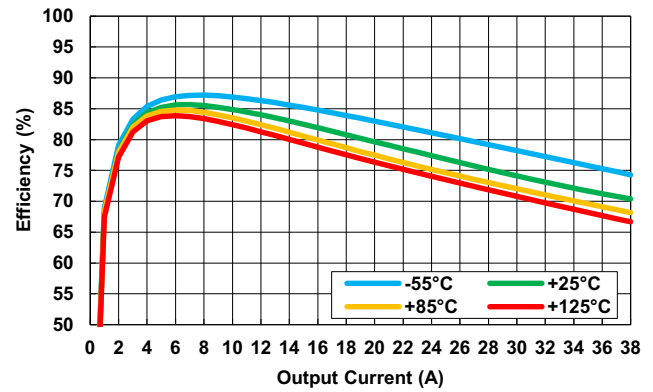

Figure 36. 5V to 1.2V Over-Temperature Efficiency

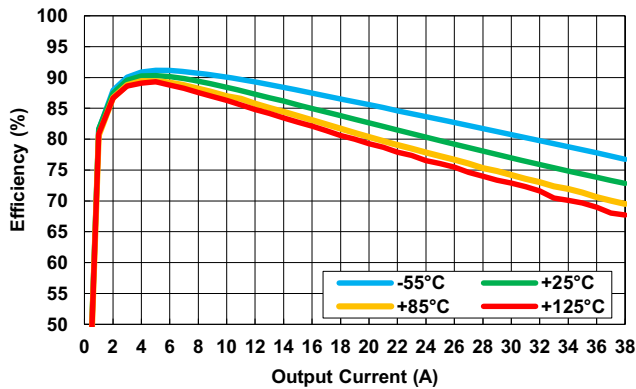

Figure 37. 3.3V to 1.5V Over-Temperature Efficiency

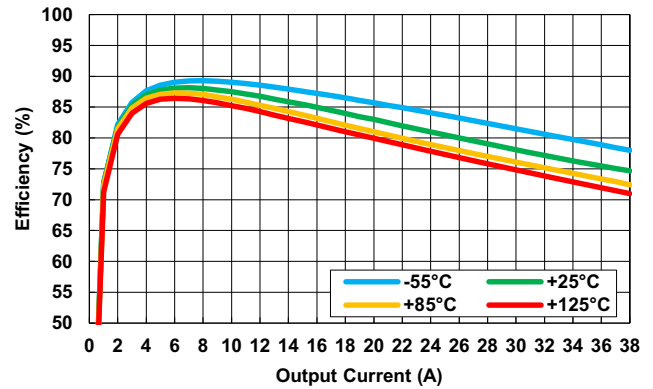

Figure 38. 5V to 1.5V Over-Temperature Efficiency

Unless noted: $V_{IN} = 3.3V$, $V_{OUT} = 0.95V$, $f_{SW} = 500kHz$, $T_A = +25^\circ C$. Efficiency curves are at the noted case temperatures (T_C) (Continued)

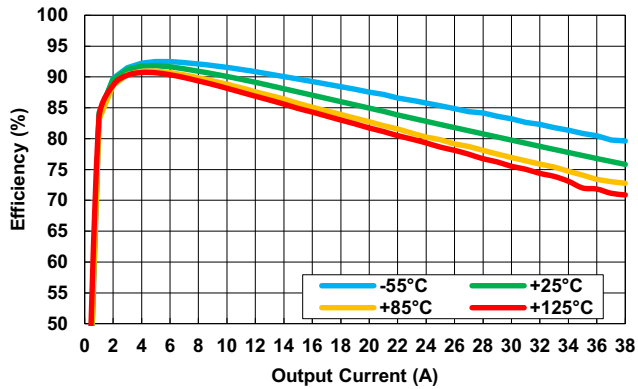

Figure 39. 3.3V to 1.8V Over-Temperature Efficiency

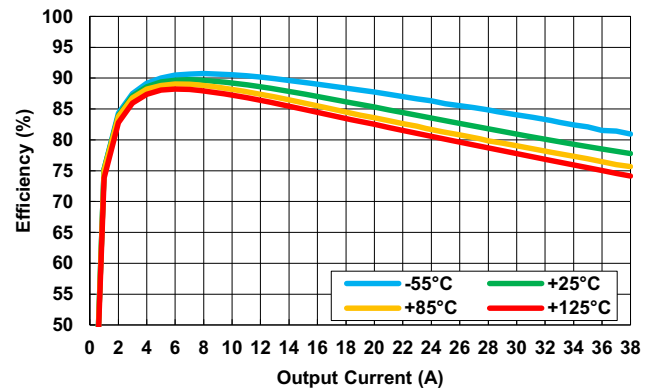

Figure 40. 5V to 1.8V Over-Temperature Efficiency

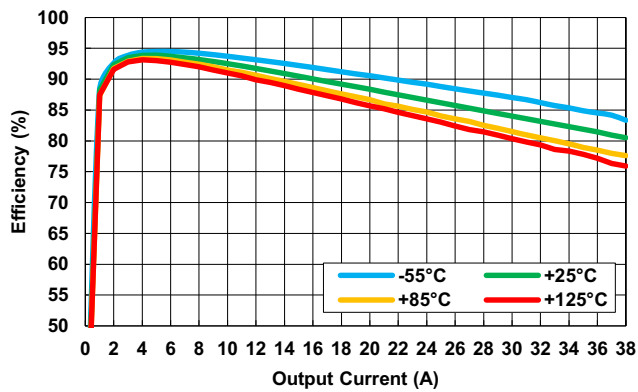

Figure 41. 3.3V to 2.5V Over-Temperature Efficiency

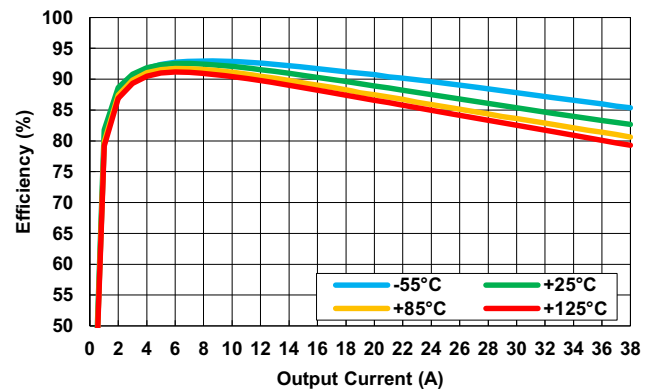

Figure 42. 5V to 2.5V Over-Temperature Efficiency

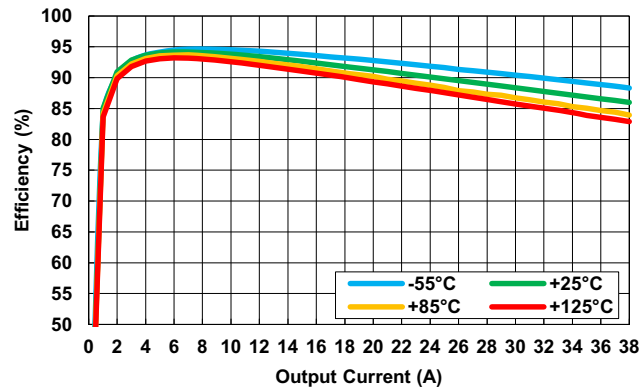

Figure 43. 5V to 3.3V Over-Temperature Efficiency

5. Revision History

Rev.	Date	Description
0.00	May 24, 2018	Initial release

Notice

1. Descriptions of circuits, software and other related information in this document are provided only to illustrate the operation of semiconductor products and application examples. You are fully responsible for the incorporation or any other use of the circuits, software, and information in the design of your product or system. Renesas Electronics disclaims any and all liability for any losses and damages incurred by you or third parties arising from the use of these circuits, software, or information.
2. Renesas Electronics hereby expressly disclaims any warranties against and liability for infringement or any other claims involving patents, copyrights, or other intellectual property rights of third parties, by or arising from the use of Renesas Electronics products or technical information described in this document, including but not limited to, the product data, drawings, charts, programs, algorithms, and application examples.
3. No license, express, implied or otherwise, is granted hereby under any patents, copyrights or other intellectual property rights of Renesas Electronics or others.
4. You shall not alter, modify, copy, or reverse engineer any Renesas Electronics product, whether in whole or in part. Renesas Electronics disclaims any and all liability for any losses or damages incurred by you or third parties arising from such alteration, modification, copying or reverse engineering.
5. Renesas Electronics products are classified according to the following two quality grades: "Standard" and "High Quality". The intended applications for each Renesas Electronics product depends on the product's quality grade, as indicated below.
"Standard": Computers; office equipment; communications equipment; test and measurement equipment; audio and visual equipment; home electronic appliances; machine tools; personal electronic equipment; industrial robots; etc.
"High Quality": Transportation equipment (automobiles, trains, ships, etc.); traffic control (traffic lights); large-scale communication equipment; key financial terminal systems; safety control equipment; etc.
Unless expressly designated as a high reliability product or a product for harsh environments in a Renesas Electronics data sheet or other Renesas Electronics document, Renesas Electronics products are not intended or authorized for use in products or systems that may pose a direct threat to human life or bodily injury (artificial life support devices or systems; surgical implantations; etc.), or may cause serious property damage (space system; undersea repeaters; nuclear power control systems; aircraft control systems; key plant systems; military equipment; etc.). Renesas Electronics disclaims any and all liability for any damages or losses incurred by you or any third parties arising from the use of any Renesas Electronics product that is inconsistent with any Renesas Electronics data sheet, user's manual or other Renesas Electronics document.
6. When using Renesas Electronics products, refer to the latest product information (data sheets, user's manuals, application notes, "General Notes for Handling and Using Semiconductor Devices" in the reliability handbook, etc.), and ensure that usage conditions are within the ranges specified by Renesas Electronics with respect to maximum ratings, operating power supply voltage range, heat dissipation characteristics, installation, etc. Renesas Electronics disclaims any and all liability for any malfunctions, failure or accident arising out of the use of Renesas Electronics products outside of such specified ranges.
7. Although Renesas Electronics endeavors to improve the quality and reliability of Renesas Electronics products, semiconductor products have specific characteristics, such as the occurrence of failure at a certain rate and malfunctions under certain use conditions. Unless designated as a high reliability product or a product for harsh environments in a Renesas Electronics data sheet or other Renesas Electronics document, Renesas Electronics products are not subject to radiation resistance design. You are responsible for implementing safety measures to guard against the possibility of bodily injury, injury or damage caused by fire, and/or danger to the public in the event of a failure or malfunction of Renesas Electronics products, such as safety design for hardware and software, including but not limited to redundancy, fire control and malfunction prevention, appropriate treatment for aging degradation or any other appropriate measures. Because the evaluation of microcomputer software alone is very difficult and impractical, you are responsible for evaluating the safety of the final products or systems manufactured by you.
8. Please contact a Renesas Electronics sales office for details as to environmental matters such as the environmental compatibility of each Renesas Electronics product. You are responsible for carefully and sufficiently investigating applicable laws and regulations that regulate the inclusion or use of controlled substances, including without limitation, the EU RoHS Directive, and using Renesas Electronics products in compliance with all these applicable laws and regulations. Renesas Electronics disclaims any and all liability for damages or losses occurring as a result of your noncompliance with applicable laws and regulations.
9. Renesas Electronics products and technologies shall not be used for or incorporated into any products or systems whose manufacture, use, or sale is prohibited under any applicable domestic or foreign laws or regulations. You shall comply with any applicable export control laws and regulations promulgated and administered by the governments of any countries asserting jurisdiction over the parties or transactions.
10. It is the responsibility of the buyer or distributor of Renesas Electronics products, or any other party who distributes, disposes of, or otherwise sells or transfers the product to a third party, to notify such third party in advance of the contents and conditions set forth in this document.
11. This document shall not be reprinted, reproduced or duplicated in any form, in whole or in part, without prior written consent of Renesas Electronics.
12. Please contact a Renesas Electronics sales office if you have any questions regarding the information contained in this document or Renesas Electronics products.
(Note 1) "Renesas Electronics" as used in this document means Renesas Electronics Corporation and also includes its directly or indirectly controlled subsidiaries.
(Note 2) "Renesas Electronics product(s)" means any product developed or manufactured by or for Renesas Electronics.

(Rev.4.0-1 November 2017)



SALES OFFICES

Renesas Electronics Corporation

<http://www.renesas.com>

Refer to "<http://www.renesas.com/>" for the latest and detailed information.

Renesas Electronics America Inc.

1001 Murphy Ranch Road, Milpitas, CA 95035, U.S.A.
Tel: +1-408-432-8888, Fax: +1-408-434-5351

Renesas Electronics Canada Limited

9251 Yonge Street, Suite 8309 Richmond Hill, Ontario Canada L4C 9T3
Tel: +1-905-237-2004

Renesas Electronics Europe Limited

Dukes Meadow, Millboard Road, Bourne End, Buckinghamshire, SL8 5FH, U.K
Tel: +44-1628-651-700, Fax: +44-1628-651-804

Renesas Electronics Europe GmbH

Arcadiastrasse 10, 40472 Düsseldorf, Germany
Tel: +49-211-6503-0, Fax: +49-211-6503-1327

Renesas Electronics (China) Co., Ltd.

Room 1709 Quantum Plaza, No.27 ZhichunLu, Haidian District, Beijing, 100191 P. R. China
Tel: +86-10-8235-1155, Fax: +86-10-8235-7679

Renesas Electronics (Shanghai) Co., Ltd.

Unit 301, Tower A, Central Towers, 555 Langao Road, Putuo District, Shanghai, 200333 P. R. China
Tel: +86-21-2226-0888, Fax: +86-21-2226-0999

Renesas Electronics Hong Kong Limited

Unit 1601-1611, 16/F., Tower 2, Grand Century Place, 193 Prince Edward Road West, Mongkok, Kowloon, Hong Kong
Tel: +852-2265-6688, Fax: +852 2886-9022

Renesas Electronics Taiwan Co., Ltd.

13F, No. 363, Fu Shing North Road, Taipei 10543, Taiwan
Tel: +886-2-8175-9600, Fax: +886 2-8175-9670

Renesas Electronics Singapore Pte. Ltd.

80 Bendemeer Road, Unit #06-02 Hyflux Innovation Centre, Singapore 339949
Tel: +65-6213-0200, Fax: +65-6213-0300

Renesas Electronics Malaysia Sdn.Bhd.

Unit 1207, Block B, Menara Amcorp, Amcorp Trade Centre, No. 18, Jln Persiaran Barat, 46050 Petaling Jaya, Selangor Darul Ehsan, Malaysia
Tel: +60-3-7955-9390, Fax: +60-3-7955-9510

Renesas Electronics India Pvt. Ltd.

No.777C, 100 Feet Road, HAL 2nd Stage, Indiranagar, Bangalore 560 038, India
Tel: +91-80-67208700, Fax: +91-80-67208777

Renesas Electronics Korea Co., Ltd.

17F, KAMCO Yangjae Tower, 262, Gangnam-daero, Gangnam-gu, Seoul, 06265 Korea
Tel: +82-2-558-3737, Fax: +82-2-558-5338

ISL70002SEHDEMO1Z

intersil[™]