

ISL71001MEVAL1Z

Evaluation Board

UG103
Rev.0.00
Feb 24, 2017

Description

The ISL71001MEVAL1Z evaluation board (shown in [Figure 4](#)) features the [ISL71001M](#).

The ISL71001M is a plastic packaged, radiation tolerant, high efficiency, monolithic synchronous buck regulator with integrated MOSFETs. This single-chip power solution operates over an input voltage range of 3V to 5.5V and provides a tightly regulated output voltage that is externally adjustable from 0.8V to ~85% of the input voltage.

Specifications

The ISL71001MEVAL1Z evaluation board is designed for ease of evaluation. The current rating of the ISL71001MEVAL1Z is 6A. The electrical ratings of ISL71001MEVAL1Z are shown in [Table 1](#).

TABLE 1. ELECTRICAL RATINGS

PARAMETER	RATING
Input Voltage	3V to 5.5V
Switching Frequency	1MHz
Output Voltage	1.2V
Output Current	6A rated
OCP Set Point	Typical 11A at ambient room temperature

Key Features

- Easy to use design
- 95% efficiency for 5V V_{IN} to 3.3V V_{OUT}
- Demonstrating lightweight plastic package POL
- External frequency sync input
- PGOOD indicator
- OCP, OVP, UVP protection

Related Literature

- For a full list of related documents, visit our website - [ISL71001M](#) product page

Ordering Information

PART NUMBER	DESCRIPTION
ISL71001MEVAL1Z	Radiation tolerant synchronous buck controller evaluation platform

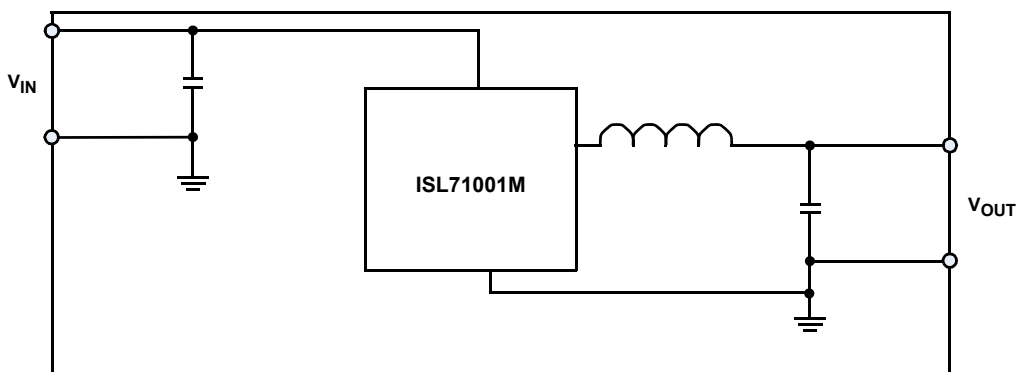

FIGURE 1. ISL71001MEVAL1Z BLOCK DIAGRAM

Recommended Testing Equipment

The following materials are recommended to perform testing:

- 0V to 6V power supply with at least 5A source current capability
- Electronic or resistive load capable of sinking 10A current
- Digital Multimeters (DMMs)
- 100MHz quad-trace oscilloscope

Quick Test Guide

1. Ensure that the circuit is correctly connected to the supply and electronic loads prior to applying any power. Refer to [Figure 3 on page 3](#) for proper setup.
2. Turn on the power supply.
3. Adjust the input voltage, V_{IN} , within the specified range and observe output voltage. The output voltage variation should be within 1%.
4. Adjust the load current within the specified range and observe output voltage. The output voltage variation should be within 1%.
5. Use an oscilloscope to observe output voltage ripple and phase node ringing. For accurate measurement, refer to [Figure 2](#) for ideal output voltage ripple test setup.

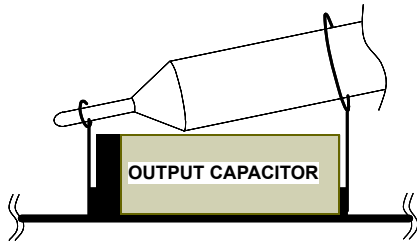

FIGURE 2. IDEAL PROBE SETUP TO MEASURE OUTPUT RIPPLE AND LX NODE RINGING

Functional Description

The ISL71001MEVAL1Z is an easy to use high-efficiency evaluation platform.

As shown in [Figure 3 on page 3](#), 3V to 5.5V V_{IN} is supplied to J2 (+) and J3 (-). The regulated 1.2V output on J16 (+) and J17 (-) is rated to supply up to 6A to the load.

Operating Range

The input voltage range is from 3V to 5.5V. The rated output load current is 6A across the entire operational voltage and -55°C to $+125^{\circ}\text{C}$ temperature envelope with the OCP point set a typical of 11A at room temperature ambient conditions.

Evaluating the Other Output Voltages

The ISL71001MEVAL1Z output is preset to 1.2V, however, the output can be adjusted from 0.8V to ~85% of the input voltage, using the adjustable resistor, R_{17} , and the J13 jumper installed. Remove J12 for adjustment.

If a hardwired output voltage is required, then programming resistor R_9 will depend on the desired output voltage of the regulator as shown in [Equation 1](#) as the value of the feedback resistor, R_{12} is set at 1k Ω .

$$R_9 = R_{12} \left(\frac{0.6}{V_{OUT} - 0.6} \right) \quad (\text{EQ. 1})$$

[Table 2](#) shows the component selection that should be used for the respective V_{OUT} of 1.8V, 2.5V, and 3.3V.

TABLE 2. EXTERNAL COMPONENT SELECTION

V_{OUT} (V)	R_9 (Ω)
1.8	499
2.5	316
3.3	221

PCB Layout Guidelines

PCB design is critical to high-frequency switching regulator performance. Careful attention to layout requirements is necessary for successful implementation of any DC/DC converter. The ISL71001M switches at a high frequency and therefore, the switching times are short. At these switching frequencies, even the shortest trace has significant impedance.

Transition speed of the current from the upper FET devices to the lower FET devices causes voltage spikes across the interconnecting impedances and parasitic circuit elements. These voltage spikes can degrade efficiency, generate EMI, and increase ringing.

Careful component selection and proper PC board layout minimizes the magnitude of these voltage spikes and undesirable voltage drops. A multilayer printed circuit board is recommended.

PCB Plane Allocation

A minimum of four layers of two ounce copper is recommended. Layers 1 and 4 should be used primarily for input and output power, signals, components, and ground as required. Layers 2 and 3 should be dedicated ground planes with the LX isolation void.

LX Connection

Use a small island of copper to connect the LXx pins of the IC to the output inductor on layers. Void the copper on Layer 2 adjacent to the island to minimize capacitive coupling to the power and ground planes.

Keep all other signal traces as short as possible.

PCB Component Placement

Components should be placed as close as possible to the IC to minimize stray inductance and resistance. Prioritize the placement of bypass capacitors on the pins of the IC in the order shown: VREF, AVDD, DVDDD, PVINx (high-frequency capacitors), EN, PGOOD, and PVINx (bulk capacitors).

Locate the output feedback voltage resistor divider as close as possible to the FB pin of the IC. The top leg of the divider should connect directly to the inductor output with a Kelvin trace and the bottom leg of the divider should connect directly to AGND. AGND should be connected to the power ground closest to an output capacitor using a Kelvin trace. The midpoint junction of the resistive divider should connect directly to the FB pin.

A small series R-C snubber connected from the LXx pins to the PGNDx pins may be used to damp high-frequency ringing on the LXx pins if desired.

The ISL71001MEVAL1Z, for purposes of characterization and evaluation, has four individual C_{OUT} bulk capacitors, three 47 μ F ceramic, and one 150 μ F Tantalum. These can be reconfigured by removal or replacement with the evaluators preference.

The ISL71001MEVAL1Z performance illustrated in this document is with all C_{OUT} capacitors installed.

The ISL71001MEVAL1Z output inductor provided, L1, is not optimized for any single operating point but is generally adequate for the purposes of the characterization and evaluation. See the [ISL71001M](#) datasheet for more details on component selection.

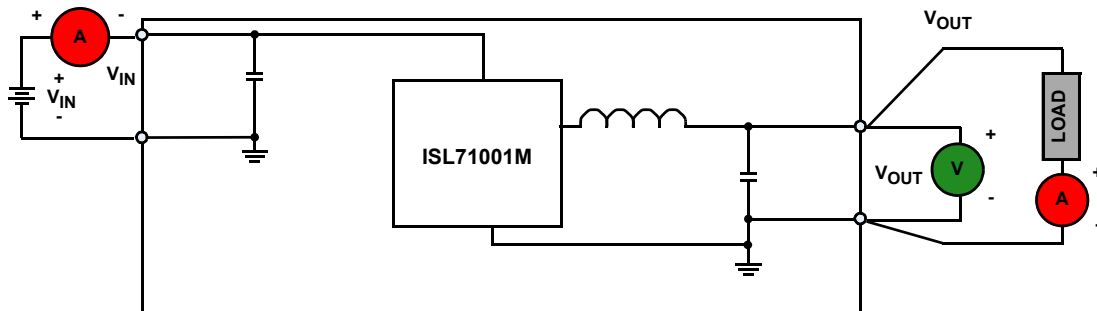

FIGURE 3. TEST SETUP



FIGURE 4. ISL71001MEVAL1Z TOP SIDE

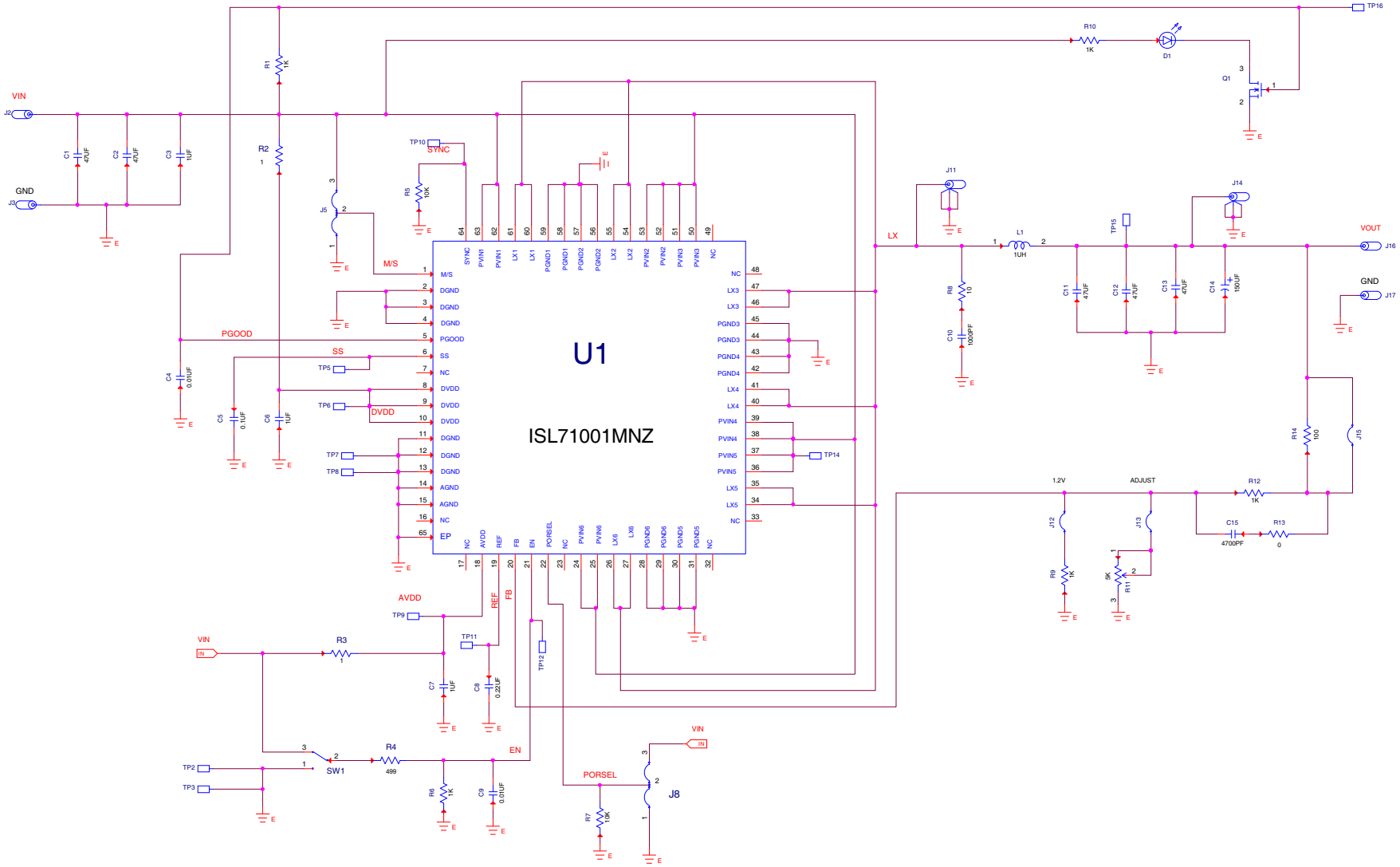

FIGURE 5. ISL71001MEVAL1Z SCHEMATIC

Schematic

ISL71001MEVAL1Z Bill of Materials

MANUFACTURER PART	QTY	REFERENCE DESIGNATOR	DESCRIPTION	MANUFACTURER
ISL71001MNZ	1	U1	6A Radiation Tolerant Sync Buck Regulator	INTERSIL
T530D157M010ATE006	1	C14	150 μ F, 6m Ω ESR Conductive Polymer Capacitor	KEMET
CDRH127/LD-1R0NC	1	L1	1 μ H Power Inductor	SUMIDA
GRM188R71A105KA61D	3	C3, C6, C7	1 μ F Multilayer Cap	MURATA
GRM32ER71A476KE15L	5	C1, C2, C11-C13	47 μ F Ceramic Chip Cap	MURATA
H1045-00102-16V10	1	C10	Multilayer Cap	GENERIC
H1045-00103-16V10	2	C4, C9	Multilayer Cap	GENERIC
H1045-00104-16V10	1	C5	Multilayer Cap	GENERIC
H1045-00224-16V10	1	C8	Multilayer Cap	GENERIC
H1045-00472-50V10	1	C15	Multilayer Cap	GENERIC
H2511-00010-1/16W1	2	R2,R3	Thick Film Chip Resistor	GENERIC
H2511-00R00-1/16W1	1	R13	Thick Film Chip Resistor	GENERIC
H2511-01000-1/16W1	1	R14	Thick Film Chip Resistor	GENERIC
H2511-01001-1/16W1	5	R1, R6, R9, R10, R12	Thick Film Chip Resistor	GENERIC
H2511-01002-1/16W1	2	R5, R7	Thick Film Chip Resistor	GENERIC
H2511-04990-1/16W1	1	R4	Thick Film Chip Resistor	GENERIC
H2513-00100-1/8W1	1	R8	Thick Film Chip Resistor	GENERIC
131-4353-00	2	J11, J14	Scope Probe Test Point PCB Mount	TEKTRONIX
3296W-1-502	1	R11	Trimmer Potentiometer	BOURNS
575-4	4	J2, J3, J16, J17	Solder Mount Banana Plug	KEYSTONE

ISL71001MEVAL1Z PCB Layout

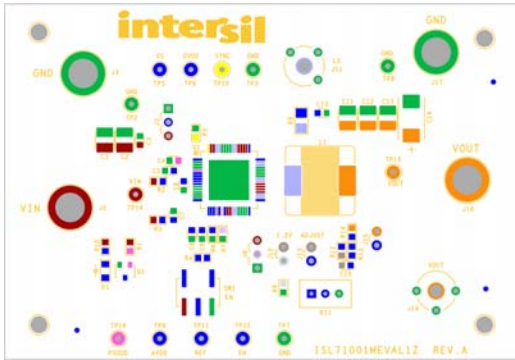

FIGURE 6. SILKSCREEN TOP

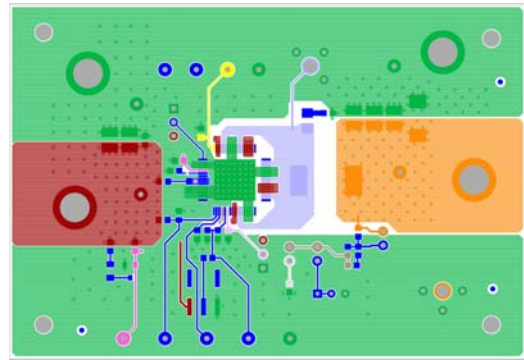

FIGURE 7. TOP LAYER

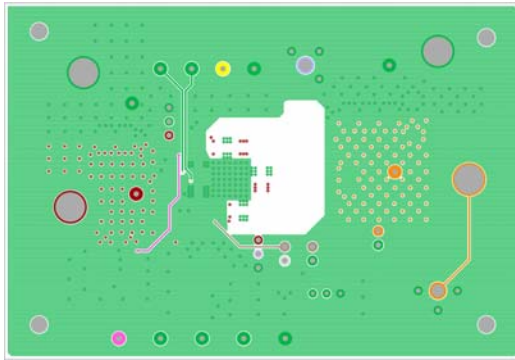

FIGURE 8. SECOND LAYER

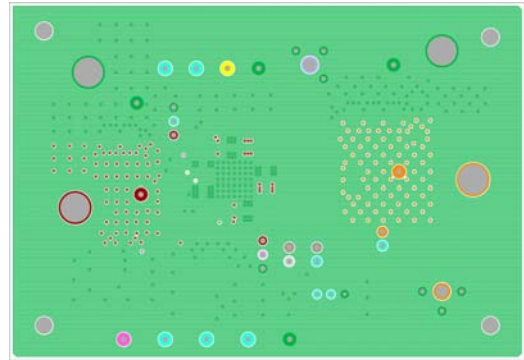

FIGURE 9. THIRD LAYER

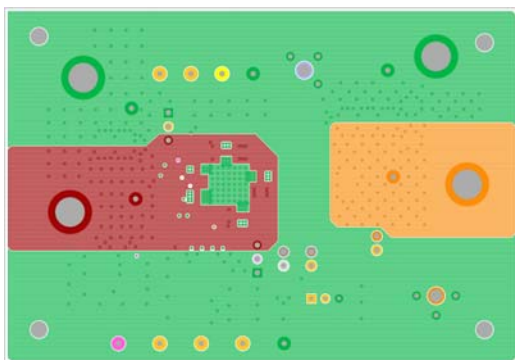

FIGURE 10. BOTTOM LAYER

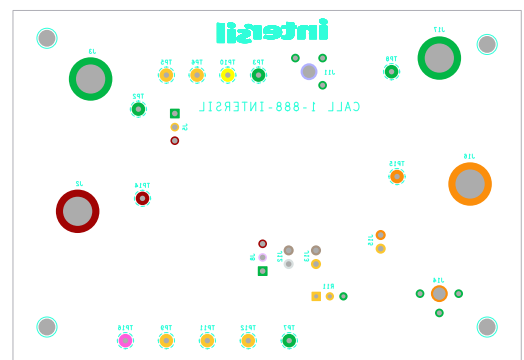

FIGURE 11. SILKSCREEN BOTTOM

© Copyright Intersil Americas LLC 2017. All Rights Reserved.
All trademarks and registered trademarks are the property of their respective owners.

Intersil Corporation reserves the right to make changes in circuit design, software and/or specifications at any time without notice. Accordingly, the reader is cautioned to verify that the document is current before proceeding.

For information regarding Intersil Corporation and its products, see www.intersil.com

Typical Evaluation Board Performance Curves $V_{IN} = 5V, V_{OUT} = 1.2V, T_A = 25^\circ C$, unless otherwise noted.

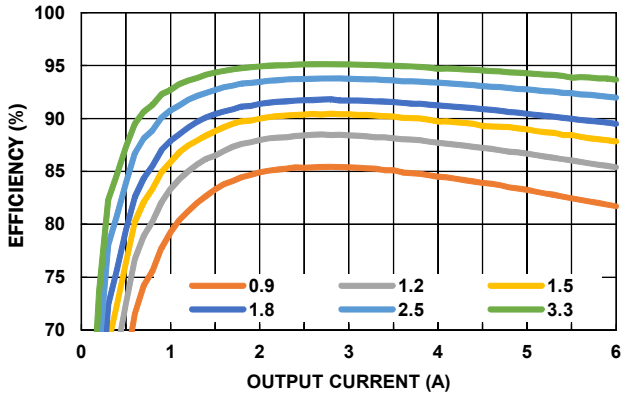

FIGURE 12. 5V V_{IN} EFFICIENCY FOR MULTIPLE V_{OUT} LEVELS

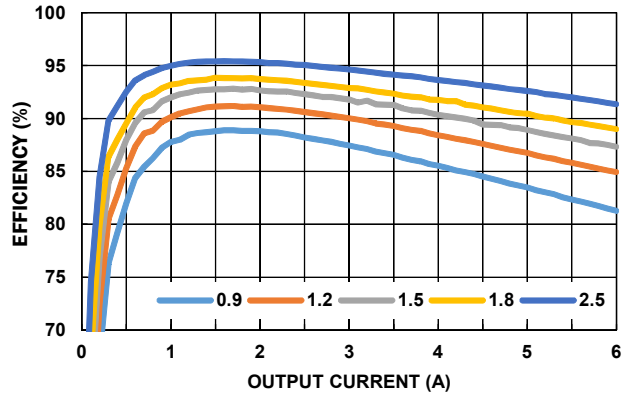

FIGURE 13. 3.3V V_{IN} EFFICIENCY FOR MULTIPLE V_{OUT} LEVELS

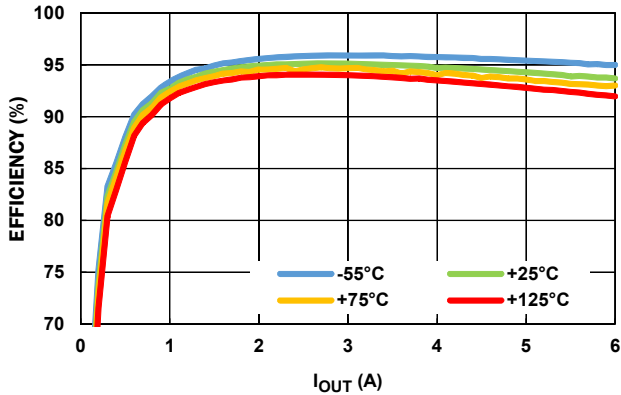

FIGURE 14. 5V V_{IN} EFFICIENCY, 3.3V V_{OUT} OVER TEMPERATURE

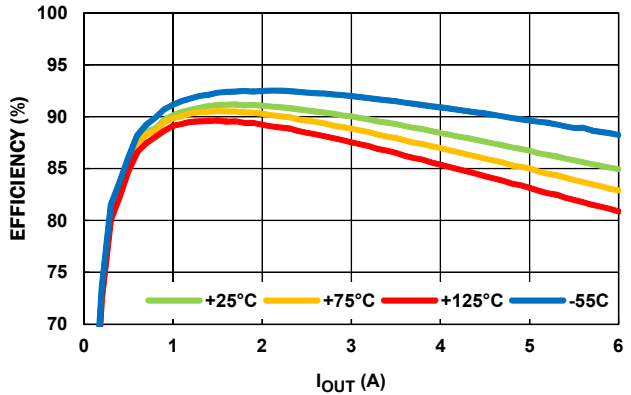

FIGURE 15. 3.3V V_{IN} EFFICIENCY, 1.2V V_{OUT} OVER TEMPERATURE

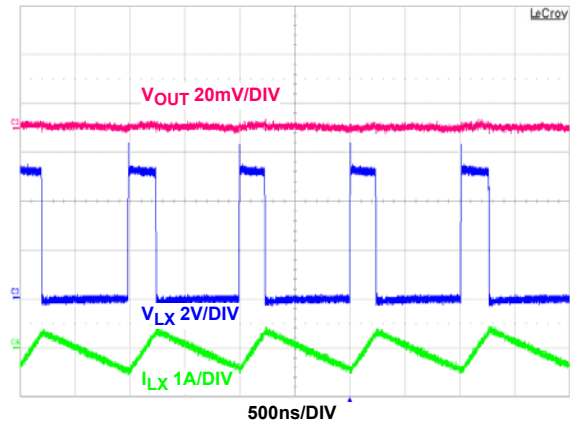

FIGURE 16. LX, V_{OUT} , AND INDUCTOR CURRENT WAVEFORMS, $I_O = 0A$

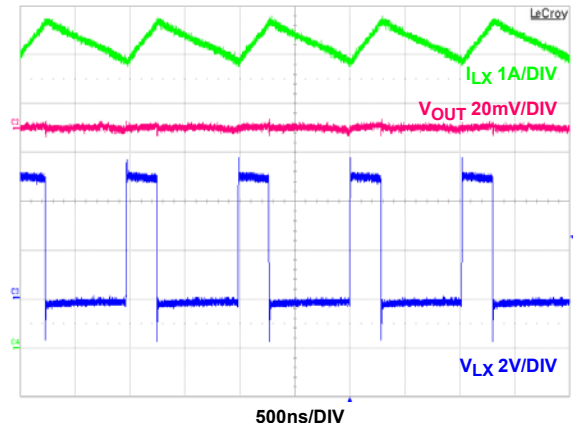

FIGURE 17. LX, V_{OUT} , AND INDUCTOR CURRENT WAVEFORMS, $I_O = 6A$

Typical Evaluation Board Performance Curves

$V_{IN} = 5V, V_{OUT} = 1.2V, T_A = 25^\circ C$, unless otherwise noted. (Continued)

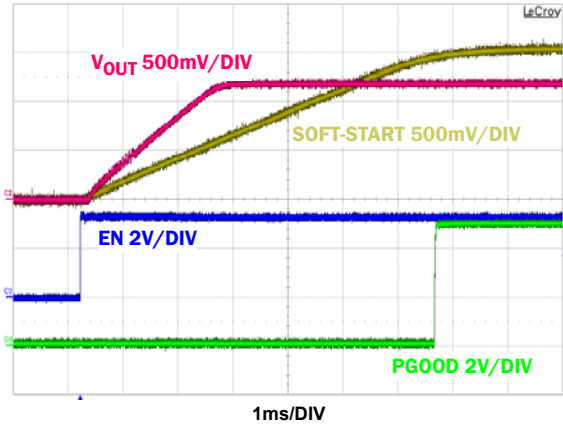

FIGURE 18. ENABLED START-UP WAVEFORMS

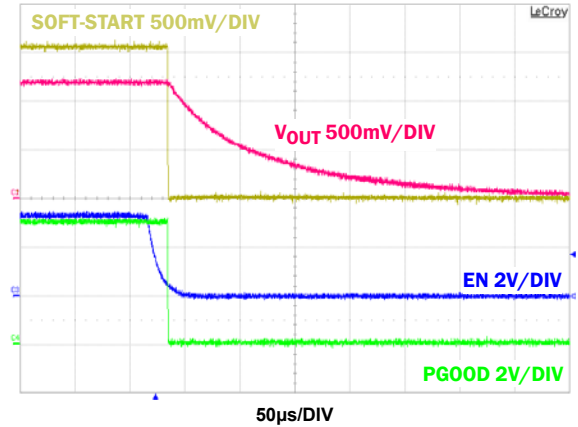

FIGURE 19. DISABLED TURN OFF WAVEFORMS

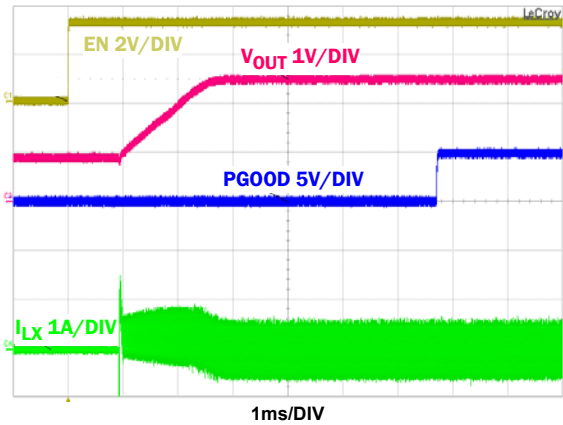

FIGURE 20. 0.5V PREBIASED START-UP TO 2.5V V_{OUT} WAVEFORMS $I_0 = 0A$

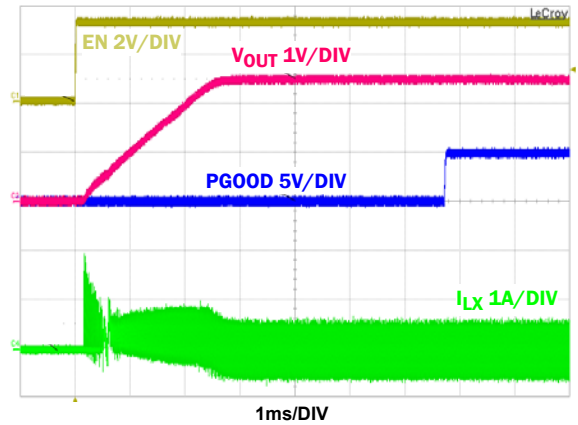

FIGURE 21. START-UP TO 2.5V V_{OUT} WAVEFORMS $I_0 = 0A$

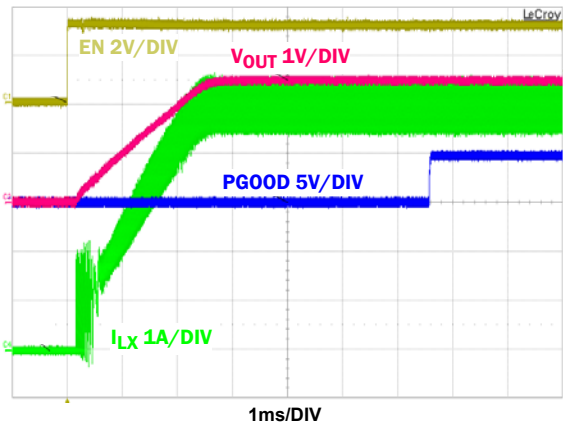

FIGURE 22. START-UP TO 2.5V V_{OUT} WAVEFORMS $I_0 = 5A$

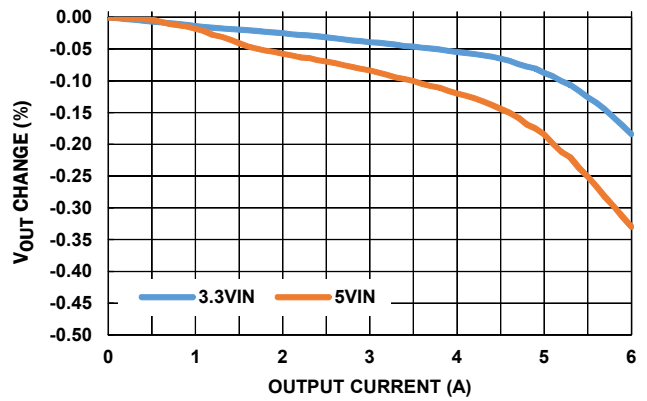

FIGURE 23. V_{IN} LOAD AND D.C. LINE REGULATION 1.2V V_{OUT}

Typical Evaluation Board Performance Curves $V_{IN} = 5V, V_{OUT} = 1.2V, T_A = 25^\circ C$, unless otherwise noted. (Continued)

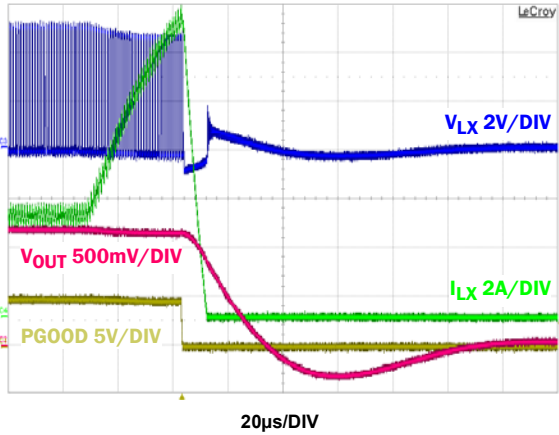

FIGURE 24. INTO OVERCURRENT WAVEFORMS

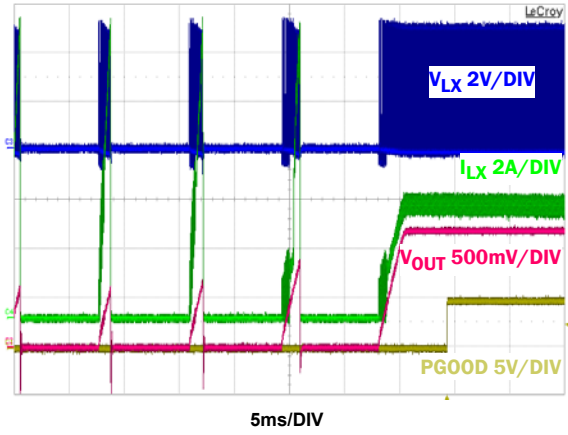

FIGURE 25. OUT OF OVERCURRENT RECOVERY WAVEFORMS

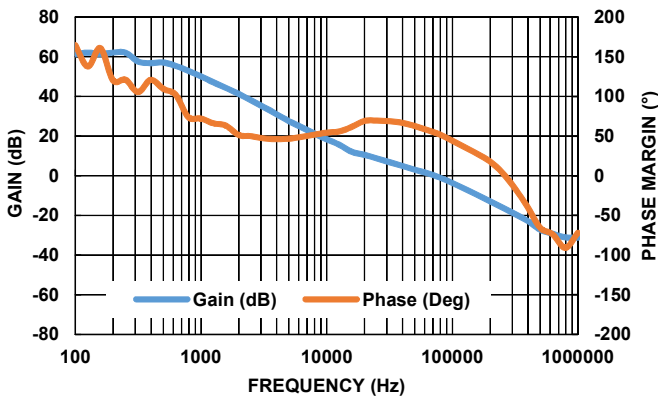

FIGURE 26. GAIN PHASE GRAPH

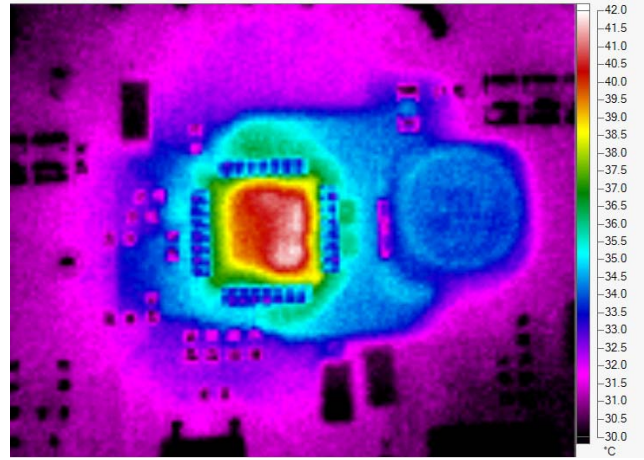

FIGURE 27. ISL71001M THERMAL IMAGE WITH 6A LOAD, MAXIMUM TEMPERATURE = +42°C

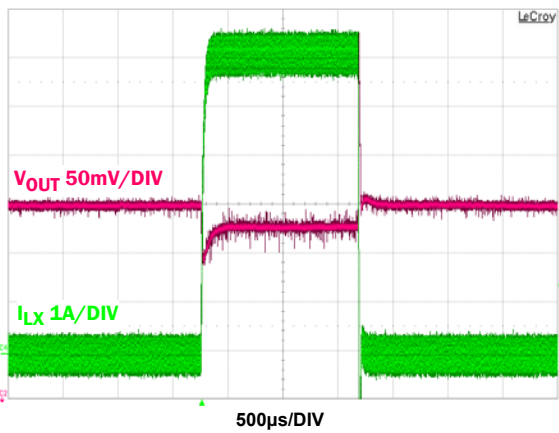

FIGURE 28. LOAD TRANSIENT 0 TO 6A

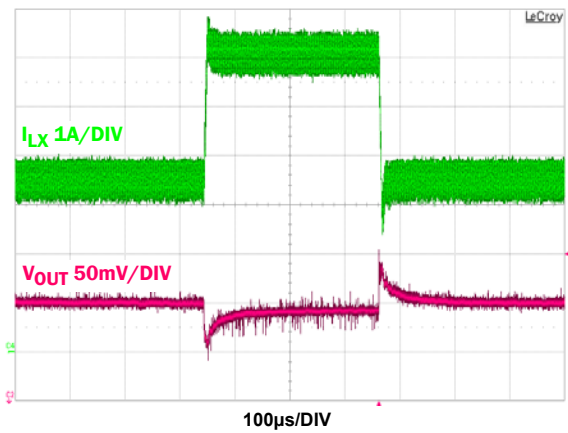

FIGURE 29. LOAD TRANSIENT 3.5A TO 6A