

ISL71043MEVAL1Z

Evaluation Board

The ISL71043MEVAL1Z evaluation platform is designed to evaluate the ISL71043M and ISL71040M in a flyback power supply configuration.

The ISL71043M is a radiation tolerant drop-in replacement for the popular 28C4x and 18C4x PWM controllers suitable for a wide range of power conversion applications including boost, flyback, and isolated output configurations. This evaluation board is a flyback power supply. The board features up to 13.2V V_{DD} operation, low operating current, 90 μ A typical start-up current, adjustable operating frequency to 1MHz, and high peak current drive capability with 50ns rise and fall times.

The ISL71040M is a low-side driver designed to drive enhancement mode Gallium Nitride (GaN) FETs in isolated topologies and boost type configurations. The ISL71040M operates with a supply voltage from 4.5V to 13.2V and has inverting (INB) and non-inverting (IN) inputs to satisfy requirements for both inverting and non-inverting gate drives with a single device. The ISL71040M has a 4.5V gate drive voltage (V_{DRV}) that is generated using an internal regulator, which prevents the gate voltage from exceeding the maximum gate-source rating of enhancement mode GaN FETs. The gate drive voltage also features an Undervoltage Lockout (UVLO) protection that ignores the inputs (IN and INB) and keeps OUTL turned on, ensuring that the GaN FET is in an OFF state when V_{DRV} is below the UVLO threshold. The ISL71040M inputs can withstand voltages up to 14.7V regardless of the V_{DD} voltage, which allows the ISL71040M inputs to be connected directly to most PWM controllers. The split outputs of the ISL71040M offer the flexibility to independently adjust the turn-on and turn-off speeds by adding additional impedance to the turn-on and turn-off paths.

Key Features

- 24W flyback power supply
- Option to power the ISL71043M and ISL71040M using the auxiliary winding on a flyback transformer or separate power supply
- V_{OUT} within 1% of 12V with 0A to 2A load step
- Tight line/load regulation: 0.003%/0.16%

Specifications

- Wide V_{IN} range single: 22V to 36V
- Wide V_{DD} range single: 7.5V to 13.2V
- I_{OUT} range: 0A to 2A

Ordering Information

Part Number	Description
ISL71043MEVAL1Z	Flyback Power Supply

Related Literature

For a full list of related documents, visit our website:

- [ISL71043M](#) and [ISL71040M](#) device pages

1. Functional Description

The ISL71043MEVAL1Z is a flyback power supply that takes an input voltage between 22V and 36V and outputs 12V with a max load capability of 2A.

1.1 Operating Range

The ISL71043M offers a wide operating supply range of 8V to 13.2V. The ISL71040M accepts a V_{DD} range of 4.5V to 13.2V. The gate drive voltage for the ISL70023SEH is generated by the ISL71040M from an internal linear regulator to keep the gate-to-source voltage below the absolute maximum VGS level of 6V.

1.2 Quick Start Guide

1. Choose how VDD for the ISL71043M and ISL71040M is provided:
 - a. Short Pins 1-2 on JP₁ to provide 12V VDD from an external power supply using BA₃ and BA₄.
 - b. Short Pins 2-3 on JP₁ to power the ICs from the auxiliary winding from the transformer.
2. Apply 28V to the VIN input (BA₁ and BA₂).
3. Power up VIN and VDD.
4. The 12V regulated output is on BA₅ and BA₆.
5. Monitor the VGS voltage using TP₂ and TP₃ with a short-to-ground loop connection on a scope probe.
6. Monitor the VDS voltage using TP₁₃ and TP₃ with a short-to-ground loop connection on a scope probe.
7. Use SP2 to monitor the current on the primary side.

1.3 Undervoltage Lockout (UVLO)

The ISL71043M UVLO follows a fairly standard implementation where it does not allow any operation until a valid VDD is cleared. The rising UVLO edge on the ISL71043M is 9V (maximum), while the falling edge is assured to trigger by 8V (minimum).

The ISL71040M UVLO monitors the gate drive voltage as opposed to V_{DD} . Until VDRV passes an acceptable level, the output is held low and the inputs are ignored, which is done due to GaN's low turn-on threshold (compared to MOSFETs). When $VDRV < \sim 1V$, an internal 500Ω resistor connected between OUTL and ground helps keep the gate voltage close to ground. When $\sim 1.2V < VDRV < UV$, OUTL is actively driven low while ignoring the logic inputs, and OUTH is in a high impedance state. The low state has the same current sinking capacity as during normal operation ensuring that the driven FETs are held off. The FETs are held off even if there is a switching voltage on the drains that can inject charge into the gates from the Miller capacitance.

When $VDRV > UVLO$, the ISL71040M waits for the next rising edge on INB or falling edge on IN before the output starts to follow the inputs. This additional check can prevent runt pulses from being generated because the first pulse is always a controlled pulse from the PWM regulator. When the UCVLO is cleared, the outputs now respond to the logic inputs. In the non-inverting operation (PWM signal applied to IN pin), the output is in-phase with the input. In the inverting operation (PWM signal applied to INB pin), the output is out-phase with the input.

For the negative transition of VDRV through the UV lockout voltage, when $VDRV < \sim 3.7V_{DC}$ the OUTL is active low and OUTH is high impedance regardless of the input logic states.

1.4 VDD Power Supply

The ISL71043MEVAL1Z provides the ability to choose how to power the VDD of the ISL71043M and ISL71040M. Using JP₁, you can choose to short Pins 2-3 to use the auxiliary winding of the transformer or short Pins 1-2 to use an external power supply.

2. General PCB Layout Guidelines

The AC performance of the ISL71040M depends significantly on the design of the Printed Circuit Board (PCB). The following layout design guidelines are recommended to achieve optimum performance:

- Place the driver as close as possible to the driven power FET.
- Understand where the switching power currents flow. The high amplitude di/dt currents of the driven power FET induce significant voltage transients on the associated traces.
- Keep power loops as short as possible by paralleling the source and return traces.
- Use planes where practical; they are usually more effective than parallel traces.
- Avoid paralleling high amplitude di/dt traces with low level signal lines. High di/dt induces currents and consequently, noise voltages in the low level signal lines.
- When practical, minimize impedances in low level signal circuits. The noise, magnetically induced on a 10k Ω resistor, is 10 times larger than the noise on a 1k Ω resistor.
- Be aware of magnetic fields emanating from transformers and inductors. Gaps in the magnetic cores of these structures are especially bad for emitting flux.
- If you must have traces close to magnetic devices, align the traces so that they are parallel to the flux lines to minimize coupling.
- The use of low inductance components such as chip resistors and chip capacitors is highly recommended
- Use decoupling capacitors to reduce the influence of parasitic inductance in the VDRV, VDD, and GND leads. To be effective, these capacitors must also have the shortest possible conduction paths. If vias are used, connect several paralleled vias to reduce the inductance of the vias.
- It may be necessary to add resistance to dampen resonating parasitic circuits, especially on OUTH. If an external gate resistor is unacceptable, then the layout must be improved to minimize lead inductance.
- Keep high dv/dt nodes away from low level circuits. Guard banding can be used to shunt away dv/dt injected currents from sensitive circuits, which is especially true for control circuits that source the input signals to the ISL71040M.
- Avoid having a signal ground plane under a high amplitude dv/dt circuit, which injects di/dt currents into the signal ground paths.
- Calculate power dissipation and voltage drop for the power traces. Many PCB/CAD programs have built in tools for trace resistance calculation.
- Large power components (such as power FETs, electrolytic caps, and power resistors) have internal parasitic inductance that cannot be eliminated., which must be accounted for in the PCB layout and circuit design.
- If you simulate your circuits, consider including parasitic components, especially parasitic inductance.
- The GaN FETs have a separate substrate connection that is internally tied to the source pin. Source and substrate should be at the same potential. Limit the inductance in the OUTH/L to Gate trace by keeping it as short and thick as possible.

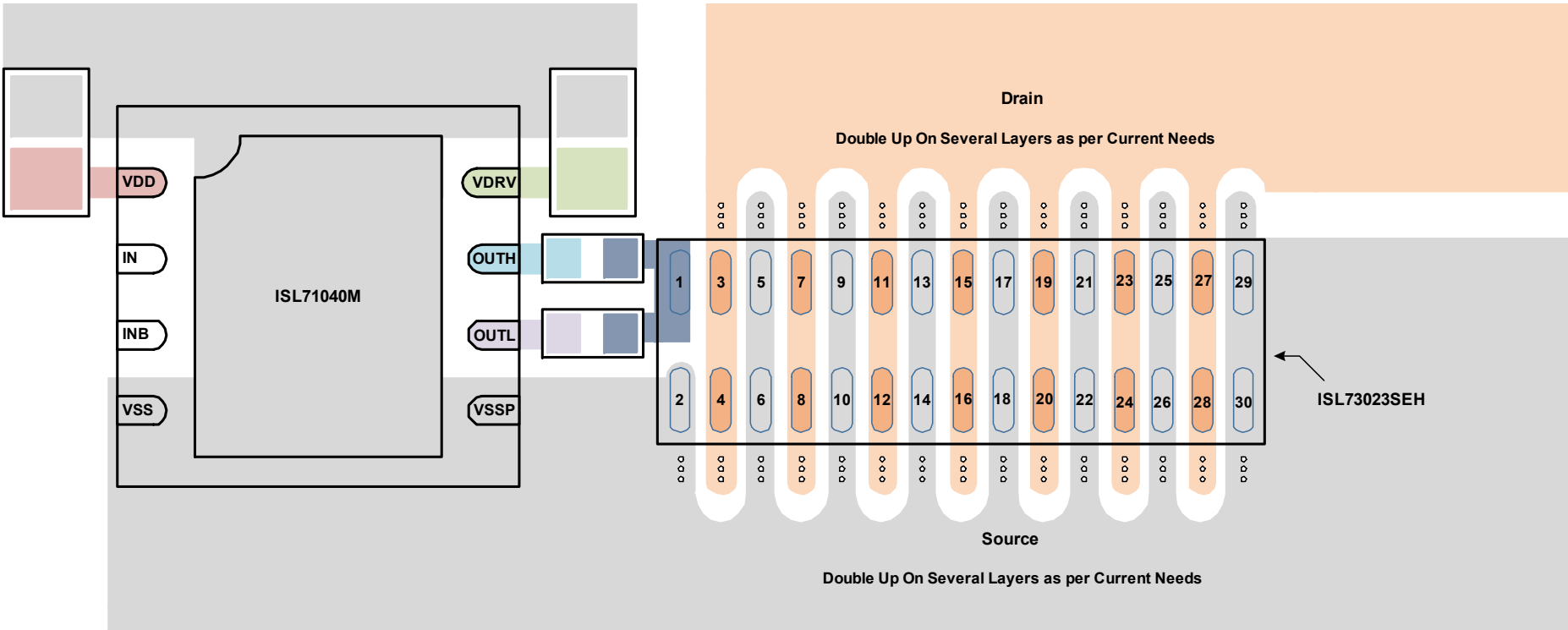

Figure 1. PCB Layout Recommendation

2.1 ISL71043MEVAL1Z Evaluation Board

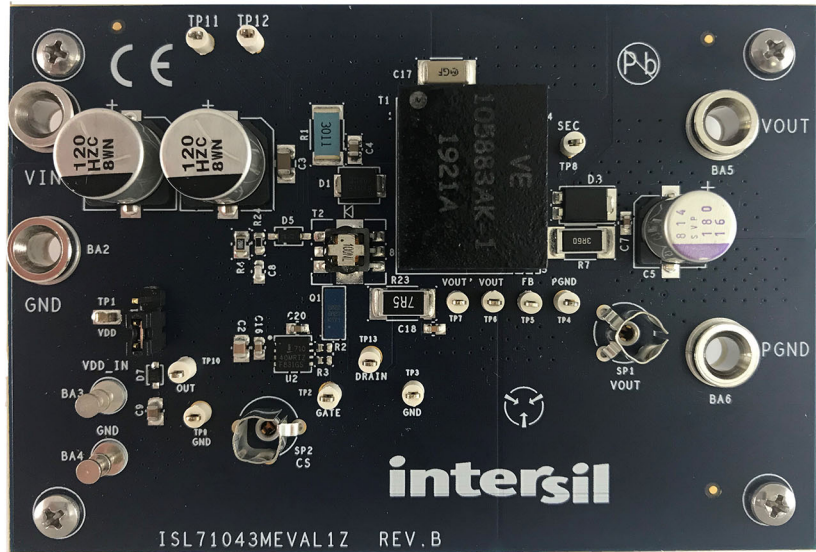

Figure 2. ISL71043MEVAL1Z Evaluation Board, Top View

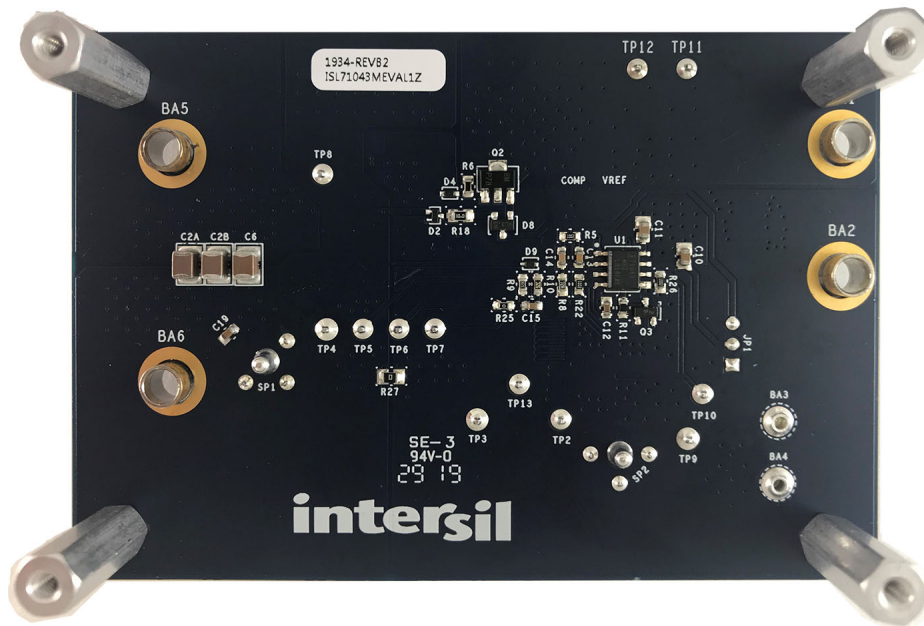

Figure 3. ISL71043MEVAL1Z Evaluation Board, Bottom View

2.2 ISL71043MEVAL1Z Schematic Diagram

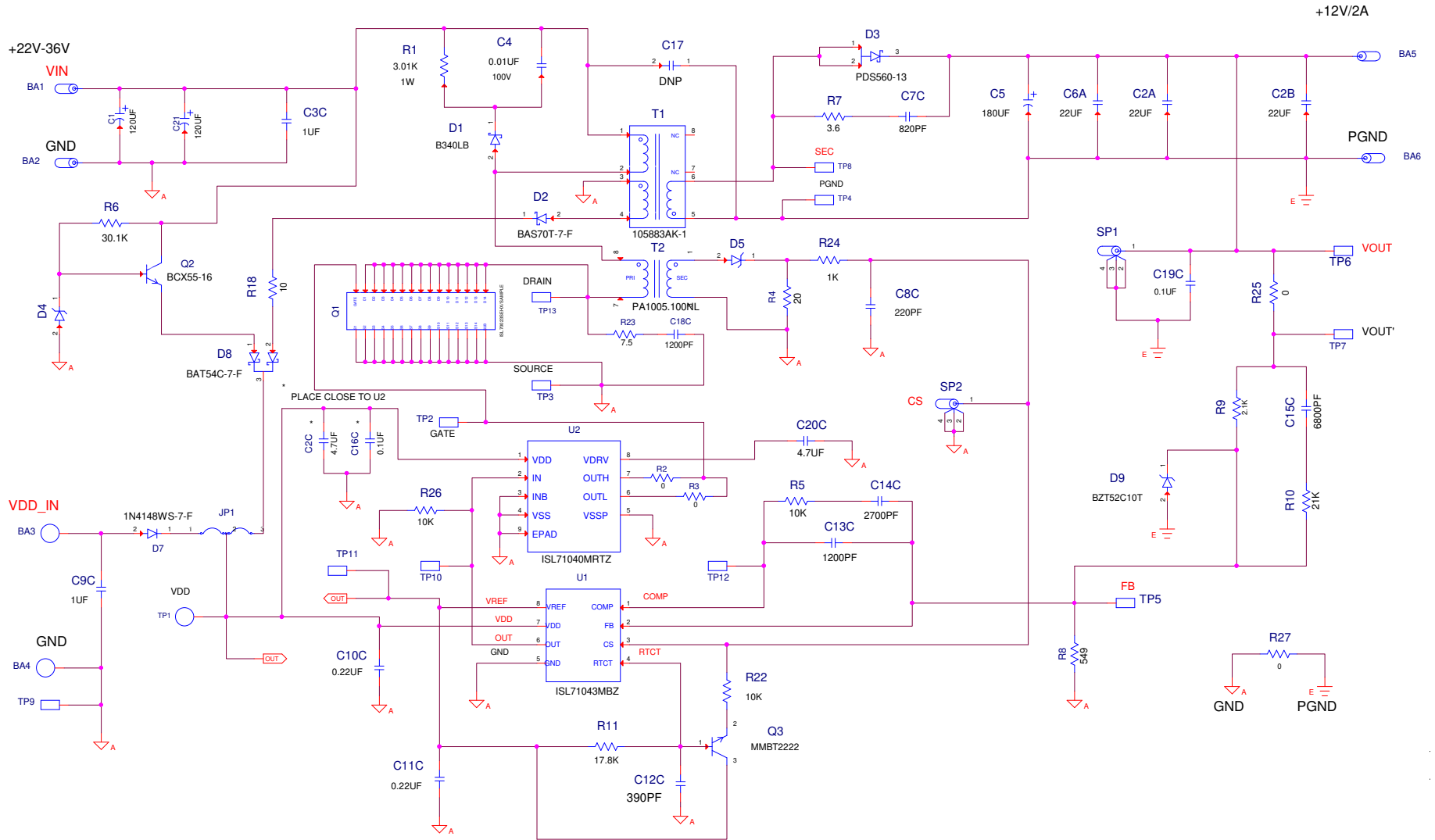

Figure 4. ISL71043MEVAL1Z Schematic

2.3 Bill of Materials

Qty	Reference Designator	Description	Manufacturer	Manufacturer Part
1		PWB-PCB, ISL71043MEVAL1Z, REVB, ROHS	Imagineering Inc	ISL71043MEVAL1ZREVBPCB
1	C2	CAP-AEC-Q200, SMD, 0805, 4.7µF, 25V, 10%, X7R, ROHS	TDK	CGA4J1X7R1E475K125AC
2	C16, C19	CAP, SMD, 0603, 0.1µF, 50V, 10%, X7R, ROHS	AVX	06035C104KAT2A
2	C13, C18	CAP, SMD, 0603, 1200pF, 50V, 10%, X7R, ROHS	Panasonic	ECJ-1VB1H122K
1	C8	CAP, SMD, 0603, 220pF, 50V, 5%, C0G, ROHS	Venkel	C0603COG500-221JNE
1	C14	CAP, SMD, 0603, 2700pF, 50V, 10%, X7R, ROHS	Panasonic	ECJ-1VB1H272K
1	C12	CAP, SMD, 0603, 390pF, 50V, 5%, NP0, ROHS	Panasonic	ECJ-1VC1H391J
1	C20	CAP, SMD, 0603, 4.7µF, 10V, 10%, X5R, ROHS	Venkel	C0603X5R100-475KNE
1	C15	CAP, SMD, 0603, 6800PF, 50V, 10%, X7R, ROHS	AVX	06035C682KAT9A
1	C7	CAP, SMD, 0603, 820pF, 50V, 10%, X7R, ROHS	Kemet	C0603C821K5RACTU
1	C4	CAP, SMD, 0805, 0.01µF, 100V, 10%, X7R, ROHS	Panasonic	ECJ-2VB2A103K
1	C9	CAP, SMD, 0805, 1.0µF, 25V, 10%, X5R, ROHS	AVX	08053C105KAT2A
2	C10, C11	CAP, SMD, 0805, 0.22µF, 25V, 10%, X7R, ROHS	Panasonic	Default
1	C3	CAP, SMD, 1206, 1µF, 50V, 10%, X7R, ROHS	Venkel	C1206X7R500-105KNE
3	C6, C2A, C2B	CAP, SMD, 1210, 22µF, 16V, 10%, X7R, ROHS	Murata	GRM32ER71C226KE18L
1	C5	CAP-OSCON, SMD, 8.3mm, 180µF, 16V, 20%, ROHS	Sanyo	16SVP180M
2	C1, C21	CAP-AEC-Q200, SMD, 10.3mm, 120µF, 50V, 20%, 28mOhm, ROHS	Panasonic	EEH-ZC1H121P
1	C17	CAP-X1, Y2, SMD, 2211, 1500pF, 250V, 10%, X7R, ROHS	Murata	GA352QR7GF152KW01L
2	SP1, SP2	CONN-SCOPE PROBE TEST PT, COMPACT, PCB MNT, ROHS	Tektronix	131-4353-00
2	BA3, BA4	CONN-TURRET, TERMINAL POST, TH, ROHS	Keystone	1514-2
12	TP2-TP13	CONN-MINI TEST POINT, VERTICAL, WHITE, ROHS	Keystone	5002
1	TP1	CONN-MINI TEST POINT, SMD, 0.105x0.040, ROHS	Keystone	5015
4	BA1, BA2, BA5, BA6	CONN-JACK, MINI BANANA, 0.175 PLUG, NICKEL/BRASS, ROHS	Keystone	575-4
1	JP1	CONN-HEADER, 1x3, BREAKAWY 1x36, 2.54mm, ROHS	Berg/FCI	68000-236HLF
1	D7	DIODE-RECTIFIER, SMD, SOD-323, 2P, 75V, 150mA, ROHS	Diodes Inc.	1N4148WS-7-F
1	D1	DIODE-SCHOTTKY, SMD, SMB, 2P, 40V, 3A LOW VF, ROHS	Diodes Inc.	B340LB-13-F

Qty	Reference Designator	Description	Manufacturer	Manufacturer Part
1	D2	DIODE-SCHOTTKY, SMD, SOT-523, 70V, 70mA, ROHS	Micro Commercial Co.	BAS70T-TP
1	D8	DIODE-RECTIFIER, SMD, SOT23, 30V, 200mA, DUAL DIODE, ROHS		
2	D4, D9	DIODE-ZENER, SMD, SOD-523, 10V, 150mW, ROHS	Diodes, Inc.	BZT52C10T-7
1	D5	DIODE-ZENER, SMD, SOD-123, 15V, 500mW, ROHS	Diodes, Inc.	BZT52C15-7-F
1	D3	DIODE-RECTIFIER, SMD, POWER DI5, 3P, 60V, 5A, ROHS	Diodes Inc.	PDS560-13
1	U1	IC-CURRENT MODE PWM, 8P, SOIC, 8.4V, ROHS	Renesas Electronics America	ISL71043MBZ
1	Q1	IC-DIE SAMPLE, RAD HARD 100V GAN FET	Renesas Electronics	ISL73023SEHX/SAMPLE
1	Q2	TRANSISTOR, NPN, SMD, SOT-89, 4P, 60V, 1A, ROHS	Diodes, Inc.	BCX55-16
1	Q3	TRANSISTOR, NPN, 3LD, SOT23, 40V, 600mA, ROHS		
2	R2, R3	RES, SMD, 0402, 0Ω, 1/16W, 5%, TF, ROHS	Venkel	CR0402-16W-00T
1	R25	RES, SMD, 0603, 0Ω, 1/10W, TF, ROHS	Venkel	CR0603-10W-000T
1	R24	RES, SMD, 0603, 1k, 1/10W, 1%, TF, ROHS	Panasonic	ERJ-3EKF1001V
3	R5, R22, R26	RES, SMD, 0603, 10k, 1/10W, 1%, TF, ROHS	Venkel	CR0603-10W-1002FT
1	R11	RES, SMD, 0603, 17.8k, 1/10W, 1%, TF, ROHS	Panasonic	ERJ-3EKF1782V
1	R9	RES, SMD, 0603, 2.1k, 1/10W, 1%, TF, ROHS	Yageo	9C06031A2101FKHFT
1	R10	RES, SMD, 0603, 21k, 1/10W, 1%, TF, ROHS	Venkel	CR0603-10W-2102FT
1	R8	RES, SMD, 0603, 549Ω, 1/10W, 1%, TF, ROHS	Venkel	CR0603-10W-5490FT
1	R18	RES, SMD, 0805, 10Ω, 1/8W, 1%, TF, ROHS	Venkel	CR0805-8W-10R0FT
1	R4	RES, SMD, 0805, 20Ω, 1/8W, 1%, TF, ROHS	KOA	RK73H2AT20R0F
1	R27	RES, SMD, 0805, 0Ω, 1/8W, TF, ROHS	Yageo	RC0805JR-070RL
1	R23	RES, SMD, 2512, 7.5Ω, 1W, 1%, TF, ROHS	Panasonic	ERJ-1TRQF7R5U
1	R6	RES-AEC-Q200, SMD, 0603, 30.1k, 1/10W, 0.1%, ThinFilm, ROHS	Susumu	RG1608P-3012-B-T5
1	R1	RES-AEC-Q200, SMD, 2512, 3.01k, 1W, 1%, TF, 100ppm, ROHS	KOA	RK73H3ATTE3011F
1	R7	RES-AEC-Q200, SMD, 2512, 3.6Ω, 1W, 1%, TF, 400ppm, ROHS	Stackpole	RMCF2512FT3R60
1	T2	TRANSFORMERURR.SENSE, SMD, 8x7, 6P, 20A, 1:1RATIO, ROHS	Pulse	PA1005.100NL
4	Four corners	SCREW, 4-40x1/4in, PHILLIPS, PANHEAD, STAINLESS, ROHS	Building Fasteners	PMSSS 440 0025 PH

Qty	Reference Designator	Description	Manufacturer	Manufacturer Part
4	Four corners	STANDOFF, 4-40x3/4in, F/F, HEX, ALUMINUM, 0.25 OD, ROHS	Keystone	2204
1	T1	TRANSFORMER-FLYBACK, 3.3μH, 5%, 500KHz, SMD, 8P, 0.8x0.650in, ROHS	Vanguard Electronics	105883AK-1
1	U2	IC-GaN FET Driver, MIL TEMPL.8LD, 4x4, TDFN, RoHS	Renesas	ISL71040MRTZ

2.4 Board Layout

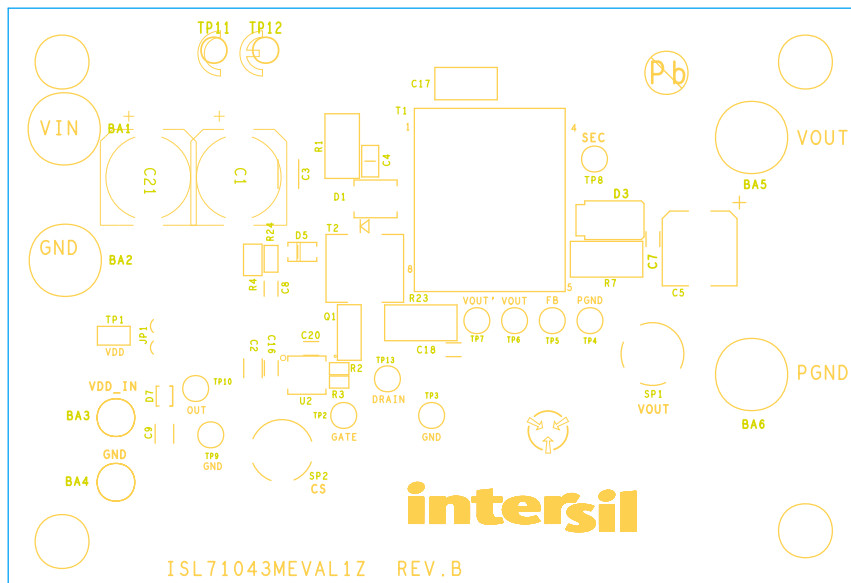

Figure 5. Top Silkscreen

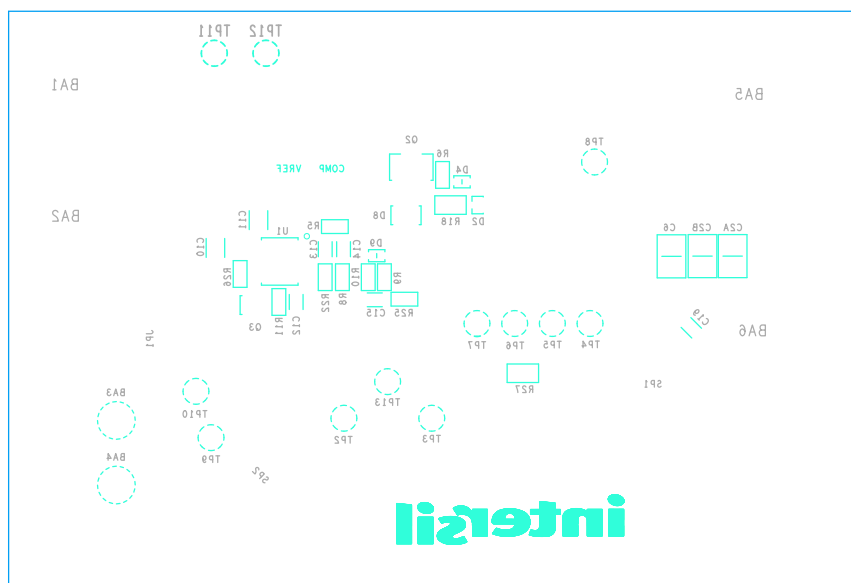

Figure 6. Bottom Silkscreen

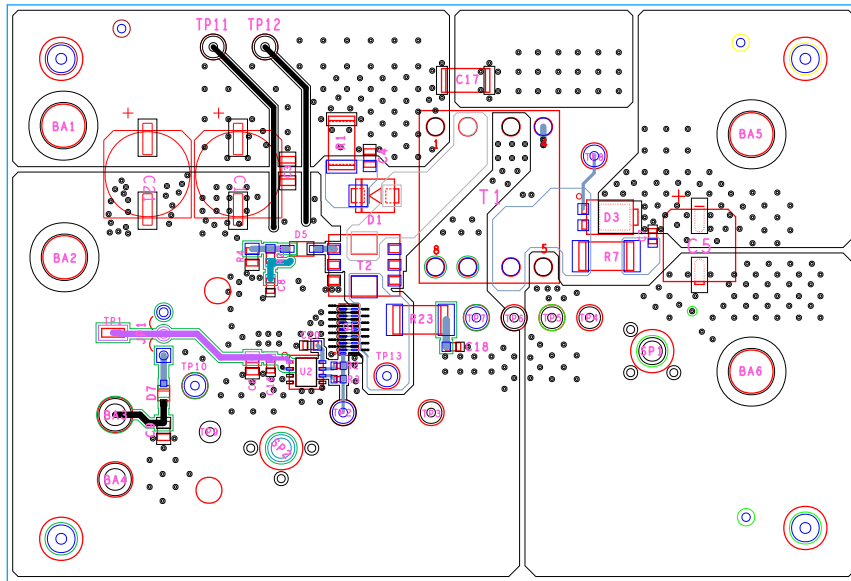

Figure 7. Top Layer

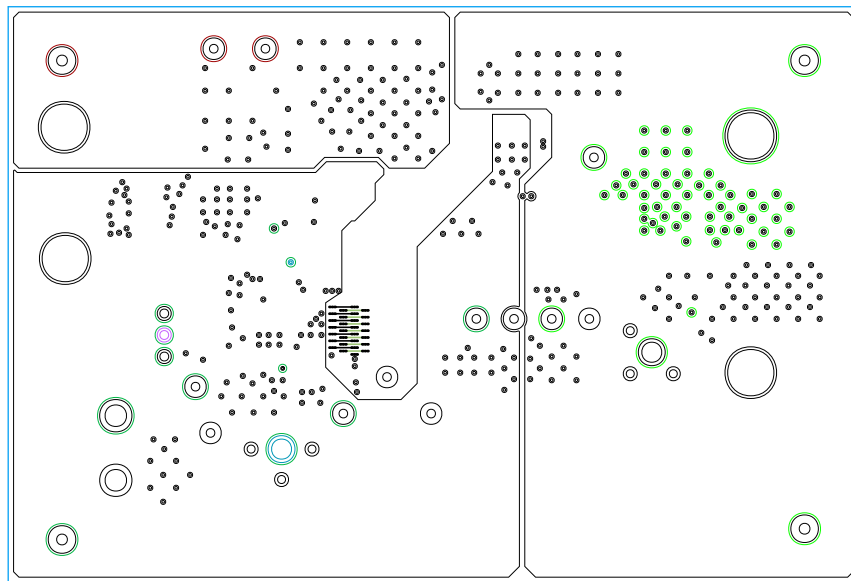

Figure 8. Second Layer

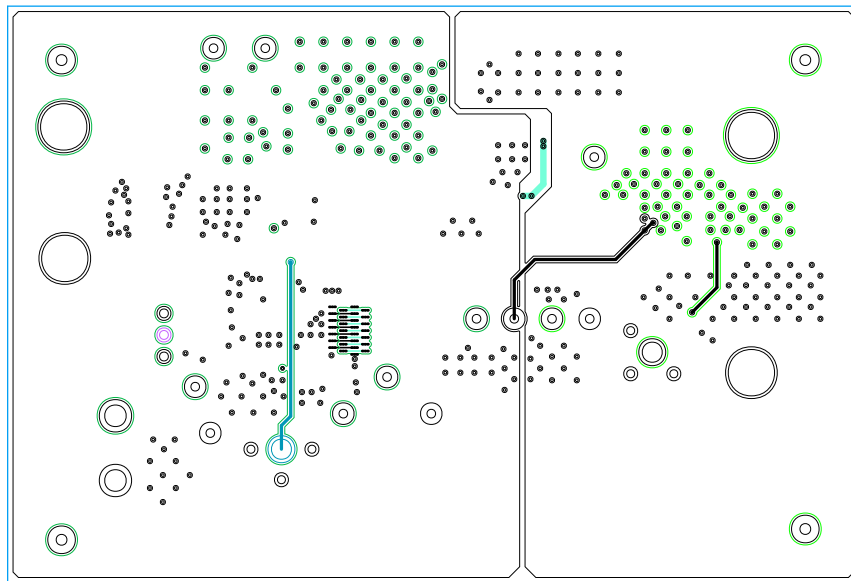

Figure 9. Third Layer

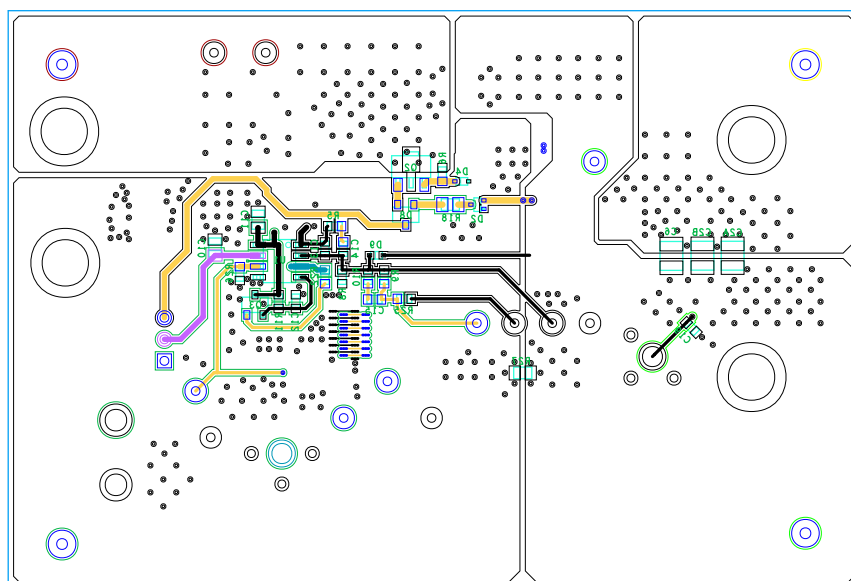

Figure 10. Bottom Layer

3. Typical Performance Curves

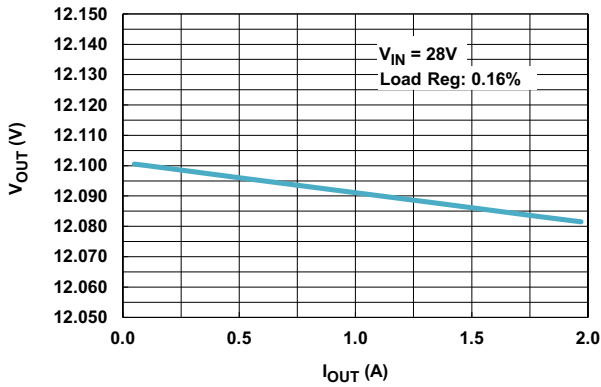

Figure 11. Load Regulation

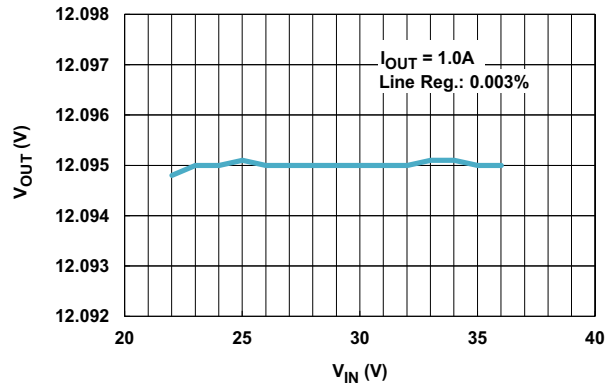

Figure 12. Line Regulation

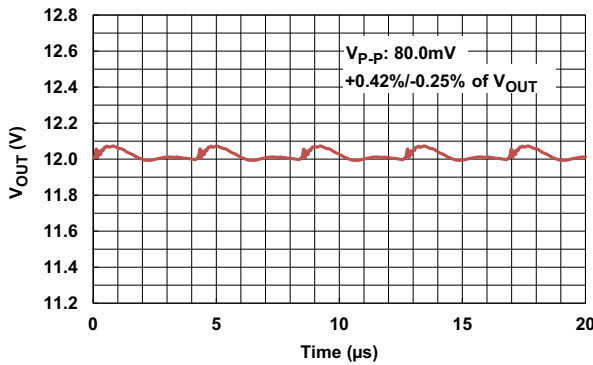

Figure 13. Output Ripple

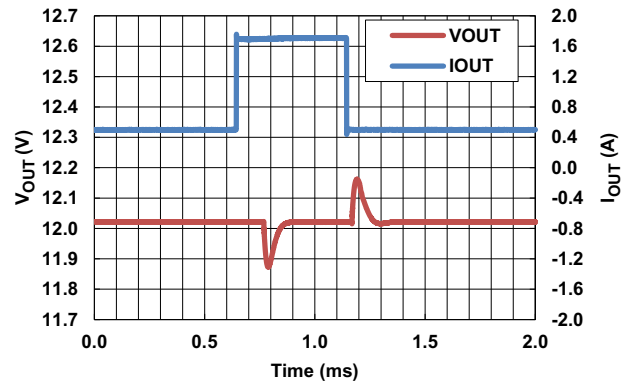

Figure 14. Step Transient

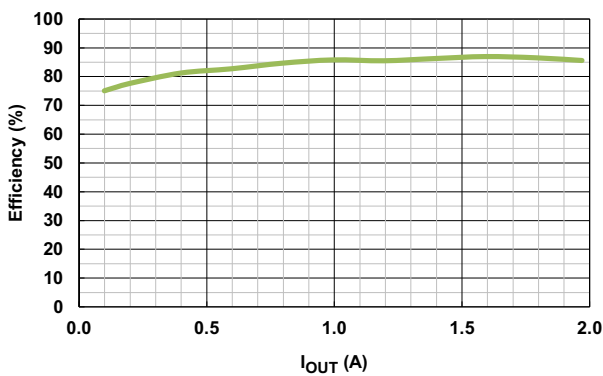

Figure 15. Efficiency

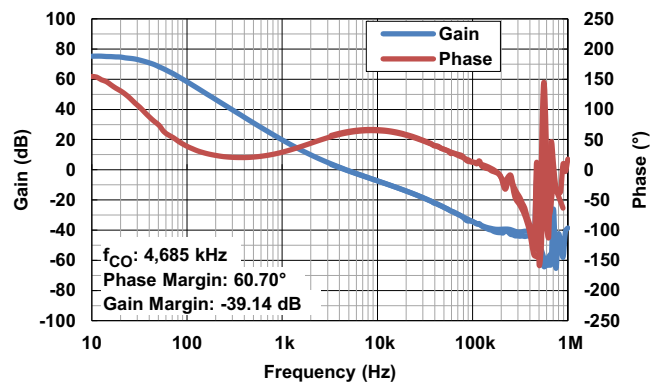

Figure 16. Stability $V_{IN} = 28V$, $V_{OUT} = 12V$, $I_{OUT} = 1A$

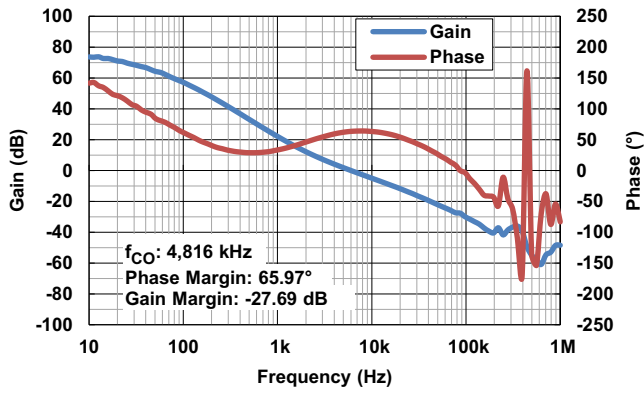

Figure 17. Stability $V_{IN} = 28V$, $V_{OUT} = 12V$, $I_{OUT} = 2A$

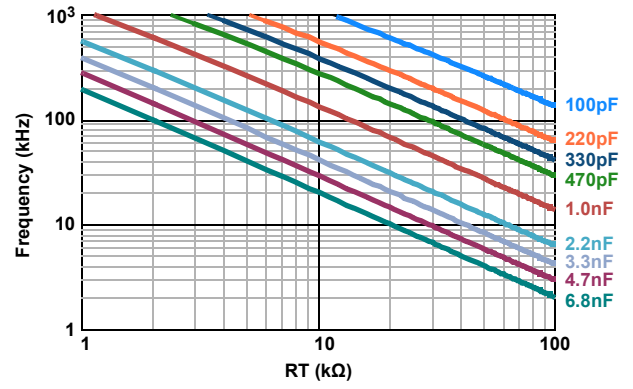

Figure 18. RTCT Frequency

4. Revision History

Rev.	Date	Description
2.0	Feb.9.21	Updated BOM, board photos, layout, and schematic.
1.0	Mar.28.19	Initial release

IMPORTANT NOTICE AND DISCLAIMER

RENESAS ELECTRONICS CORPORATION AND ITS SUBSIDIARIES (“RENESAS”) PROVIDES TECHNICAL SPECIFICATIONS AND RELIABILITY DATA (INCLUDING DATASHEETS), DESIGN RESOURCES (INCLUDING REFERENCE DESIGNS), APPLICATION OR OTHER DESIGN ADVICE, WEB TOOLS, SAFETY INFORMATION, AND OTHER RESOURCES “AS IS” AND WITH ALL FAULTS, AND DISCLAIMS ALL WARRANTIES, EXPRESS OR IMPLIED, INCLUDING, WITHOUT LIMITATION, ANY IMPLIED WARRANTIES OF MERCHANTABILITY, FITNESS FOR A PARTICULAR PURPOSE, OR NON-INFRINGEMENT OF THIRD PARTY INTELLECTUAL PROPERTY RIGHTS.

These resources are intended for developers skilled in the art designing with Renesas products. You are solely responsible for (1) selecting the appropriate products for your application, (2) designing, validating, and testing your application, and (3) ensuring your application meets applicable standards, and any other safety, security, or other requirements. These resources are subject to change without notice. Renesas grants you permission to use these resources only for development of an application that uses Renesas products. Other reproduction or use of these resources is strictly prohibited. No license is granted to any other Renesas intellectual property or to any third party intellectual property. Renesas disclaims responsibility for, and you will fully indemnify Renesas and its representatives against, any claims, damages, costs, losses, or liabilities arising out of your use of these resources. Renesas' products are provided only subject to Renesas' Terms and Conditions of Sale or other applicable terms agreed to in writing. No use of any Renesas resources expands or otherwise alters any applicable warranties or warranty disclaimers for these products.

(Rev.1.0 Mar 2020)

Corporate Headquarters

TOYOSU FORESIA, 3-2-24 Toyosu,
Koto-ku, Tokyo 135-0061, Japan
www.renesas.com

Contact Information

For further information on a product, technology, the most up-to-date version of a document, or your nearest sales office, please visit:
www.renesas.com/contact/

Trademarks

Renesas and the Renesas logo are trademarks of Renesas Electronics Corporation. All trademarks and registered trademarks are the property of their respective owners.