

ISL72991RHEVAL2Z

Evaluation Board User Guide

UG012
Rev.1.00
January 20, 2015

Description

The ISL72991RHEVAL2Z platform showcases the radiation hardened ISL72991RH, a low dropout adjustable negative voltage regulator with an output voltage range of -2.25V to -26V. The device features a 1A output current capability, an adjustable current limit pin (ILIM) and a shutdown pin (SD) for easy on/off control.

Specifications

This board has been default configured for the following operating conditions:

- $V_{IN} = -7V$ to $-26V$
- $V_{OUT} = -5V$
- $I_{MAX} = 0.8A$
- Board temperature: $+25^{\circ}C$

Key Features

- Small, compact design
- V_{IN} range of $-3V$ to $-30V$
- V_{OUT} adjustable from $-2.25V$ to $-26V$
- Convenient power connection

References

[ISL72991RH Datasheet](#)

Ordering Information

PART NUMBER	DESCRIPTION
ISL72991RHEVAL2Z	ISL72991RHEVAL2Z Evaluation Kit

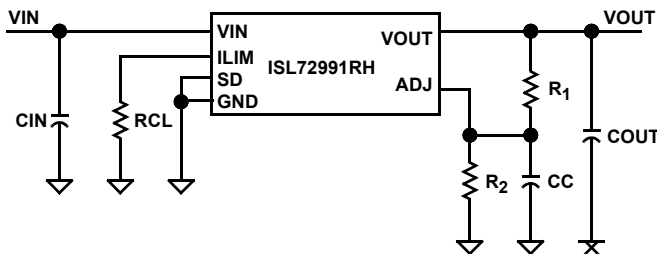

FIGURE 1. ISL72991RHEVAL2Z TYPICAL USAGE BLOCK DIAGRAM

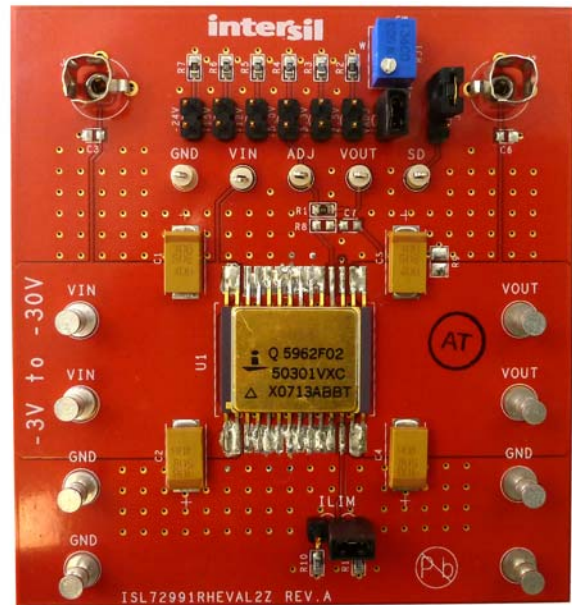

FIGURE 2. ISL72991RHEVAL2Z TOP SIDE

Functional Description

The ISL72991RHEVAL2Z board provides a simple platform to demonstrate the features and functionality of this negative voltage regulator. Capable of being biased from -3V to -30V the ISL72991RH is ideal for generating up to 1A of load current limited by its power dissipation driven die temperature for output voltages ranging from -2.25V to -26V. This platform features adjustable voltage and current limiting along with a signalled turn-on via the SD input or turn-on as input voltage is applied.

By default, the ISL72991RHEVAL2Z is configured for an output voltage of -5V and a 0.8A current limit and also allowing for easy adjustment of both of these operating points.

The board V_{IN} range is -3V to -30V. The board V_{OUT} is default set to -5V by a jumper JP4 and can be changed by changing the jumper position including to the jumper position (JP1) that connects to a potentiometer for a custom voltage provided beyond jumper pin strapping.

The ISL72991RHEVAL2Z provides jumper configurations for several common voltages including, -2.5V, -3.3V, -5.0V, -12V, -15V and -24V.

The output current limit threshold of the regulator is set with a single external resistor (R_{CL}) connected from I_{LIM} to ground.

The effective current limit at any single R_{CL} value is influenced by the V_{IN} to V_{OUT} difference, temperature and V_{IN} amplitude. Because of these numerous variables, there is no single formula relating R_{CL} to I_{CL} that will suffice for the range of likely possible operating conditions.

[Figures 7](#) through [10](#) provide guidance in setting the R_{CL} value for a limited number of possible conditions. Users are advised to evaluate their specific condition for satisfactory performance.

Operating Range

By default, the board V_{IN} range is -7V to -30V for a V_{OUT} of -5V and an I_{OUT} of up to ~0.8A, both set by jumpers. Modifying the operating conditions will change the performance results.

PCB Layout Guidelines

The ISL72991EVAL2Z PCB layout has been optimized for electrical and thermal performance.

The stability of the regulator is sensitive to layout. It is strongly recommended that a continuous copper ground plane (1 ounce or greater) be used. In addition, component lead lengths and interconnects should be minimized, but should not exceed 1/2 inch. Finally, the return lead of the compensation capacitor (C_C) should be connected as close as possible to the GND pin of the IC.

For optimum thermal performance, generally place a pattern of vias on the layer of the PCB directly underneath the IC and connect the vias to the plane which serves as a heatsink. In general, to ensure good thermal contact, thermal interface material such as a Sil-Pad or thermally conductive epoxy should be used to fill the gap between the vias and the bottom of the IC of the ceramic package.

Quick Start Guide

1. Ensure that the board is properly connected to the negative voltage supply and loads prior to applying any power.
2. Connect the negative voltage input supply to VIN (-7V to -30V)
3. Connect the load to VOUT and GND connectors.
4. Turn input power supply ON.
5. Confirm default -5V output voltage, test ISL72991RH operation.

ISL72991RHEVAL2Z Circuit Schematic

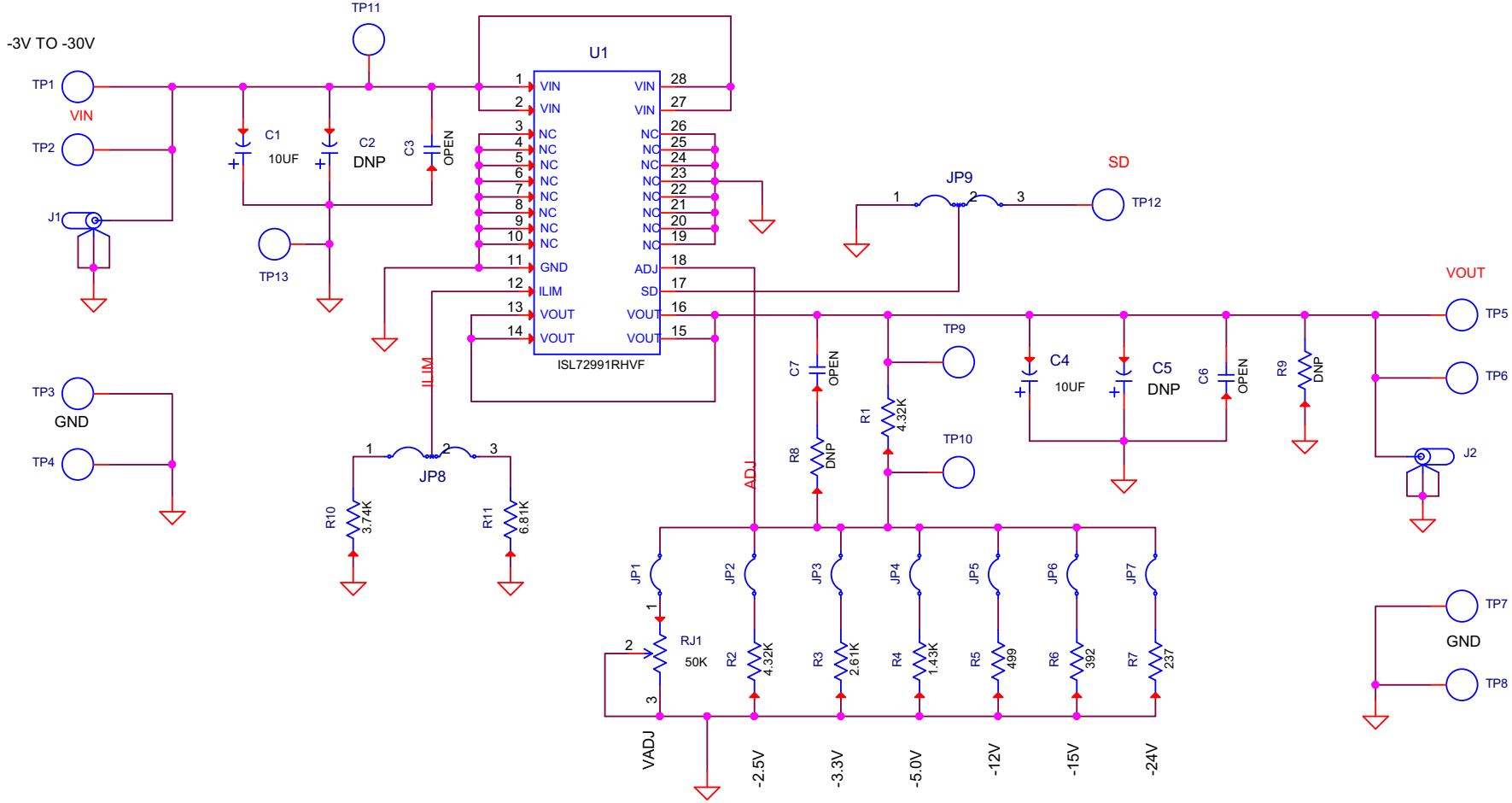

Bill of Materials

ITEM	QTY	REFERENCE DESIGNATOR	MANUFACTURER PART NUMBER	MANUFACTURER	DESCRIPTION
1	2	J1, J2	131-4353-00	TEKTRONIX	Scope Probe Test Point PCB Mount
2	8	TP1-TP8	1514-2	KEystone	Test Point Turret 0.150 Pad 0.100 Thole
3	1	RJ1	3262W-1-503	BOURNS	Trimmer Potentiometer
4	5	TP9-TP13	5002	KEystone	Miniature White Test Point 0.100 Pad 0.040 Thole
5	3	C3, C6, C7	H1045-OPEN	GENERIC	Multilayer Cap
6	1	R8	H2505-DNP-DNP-1	GENERIC	Metal Film Chip Resistor (Do Not Populate)
7	1	R9	H2506-DNP-DNP-1	GENERIC	Metal Film Chip Resistor (Do Not Populate)
8	1	R5	H2511-04990-1/16W1	GENERIC	Thick Film Chip Resistor
9	2	R1, R2	H2511-04301-1/16W1	GENERIC	Thick Film Chip Resistor
10	1	R6	H2511-03920-1/16W1	GENERIC	Thick Film Chip Resistor
11	1	R3	H2511-02611-1/16W1	GENERIC	Thick Film Chip Resistor
12	1	R7	H2511-02370-1/16W1	GENERIC	Thick Film Chip Resistor
13	1	R10	H2511-03741-1/16W1	GENERIC	Thick Film Chip Resistor
14	1	R4	H2511-01431-1/10W1	GENERIC	Thick Film Chip Resistor
15	1	R11	H2511-06811-1/16W1	GENERIC	Thick Film Chip Resistor
16	1	U1	ISL72991RHVF	INTERSIL	RH Negative Low Dropout Adjustable Voltage Regulator
17	2	JP8, JP9	JUMPER-3-100	GENERIC	Three Pin Jumper
18	7	JP1-JP7	JUMPER2_100	GENERIC	Two Pin Jumper
19	4	C1, C2, C4, C5	T491D106K050AT	KEMET	T491 Series Solid Tantalum Chip Cap

Board Layout - 2 Layers

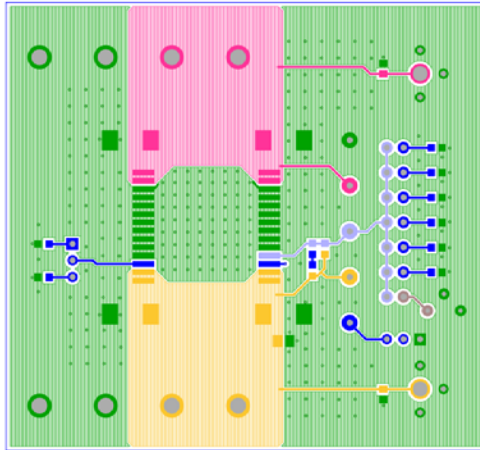

FIGURE 3. TOP LAYER

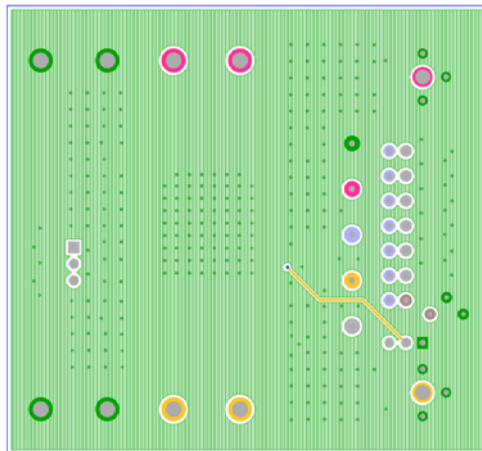

FIGURE 4. PCB - BOTTOM LAYER (VIEWED FROM TOP)

Typical Performance Curves

Unless noted: $V_{IN} = -12V$, $V_{OUT} = -5V$, $T_A = +25^\circ C$

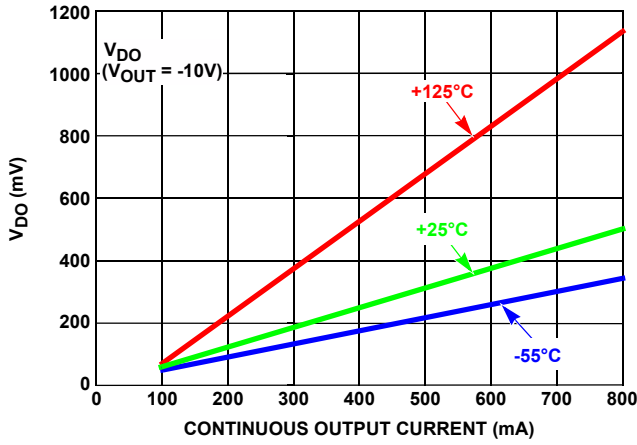

FIGURE 5. DROP-OUT VOLTAGE vs AMBIENT TEMPERATURE

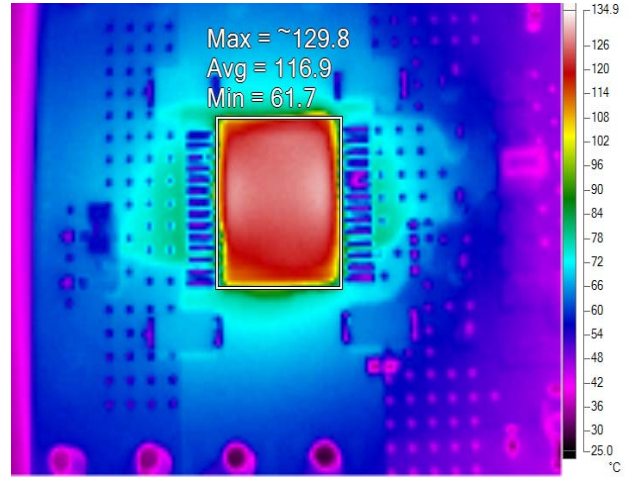

FIGURE 6. PACKAGE TEMP AT $-12V_{IN}$, $-5V_{OUT}$, 0.76A, $P_d = 5.3W$

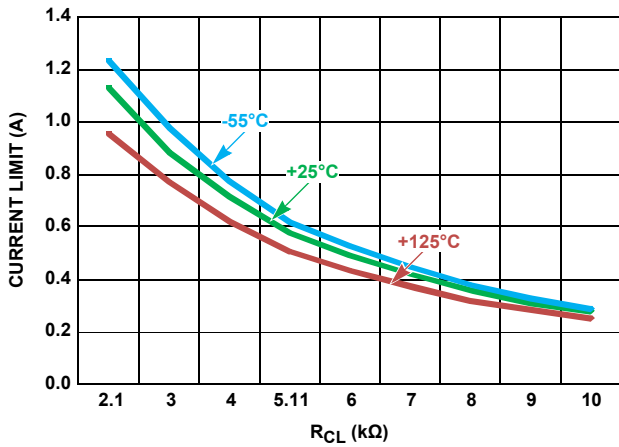

FIGURE 7. $-7V_{IN}$, $-5V_{OUT}$

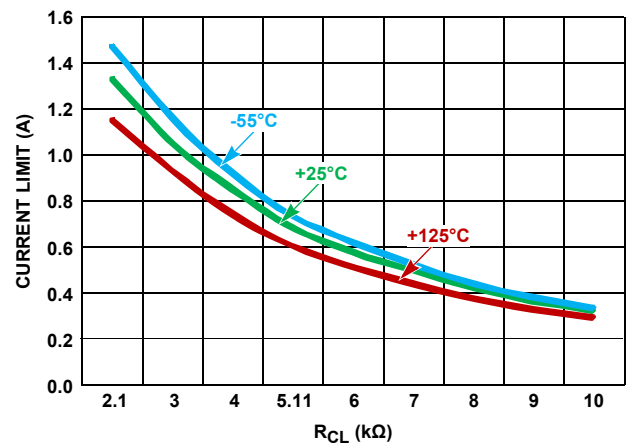

FIGURE 8. $-12V_{IN}$, $-5V_{OUT}$

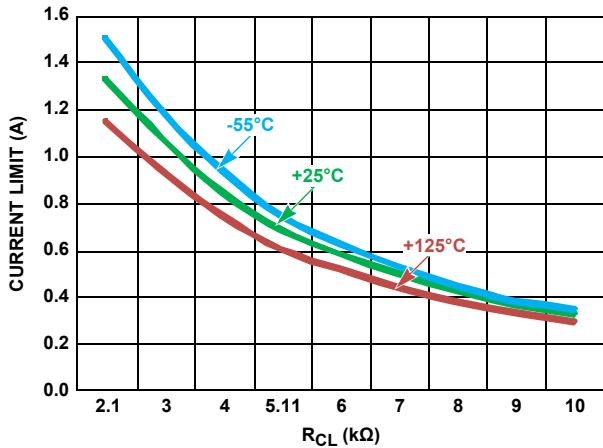

FIGURE 9. $-12V_{IN}$, $-10V_{OUT}$

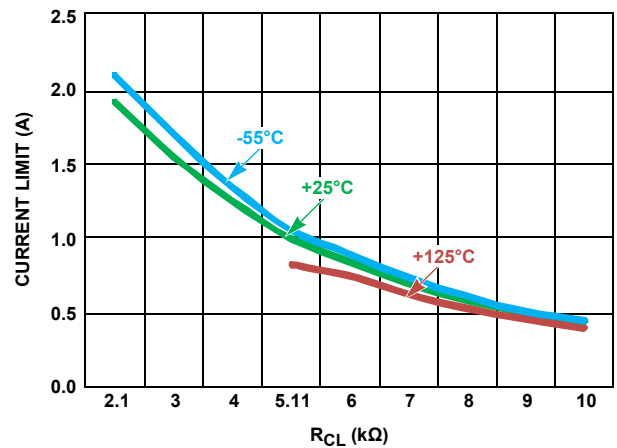

FIGURE 10. $-20V_{IN}$, $-10V_{OUT}$

Dynamic Response

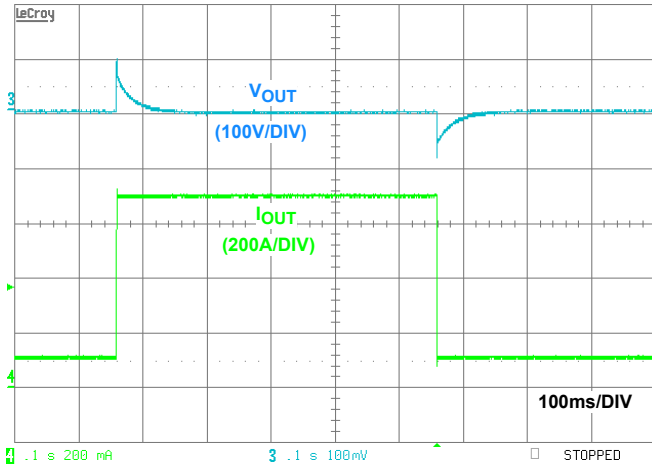

FIGURE 11. 0.1A TO 0.7A LOAD STEP. V_{OUT} IS AC COUPLED TO ILLUSTRATE THE EXTENT OF VOLTAGE DEFLECTION

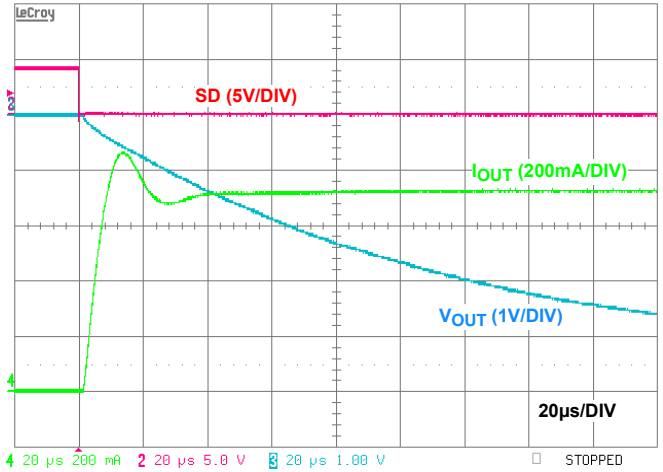

FIGURE 12. SD ENABLE ON INTO 0.76A LOAD, $V_{IN} = -12V$, $V_{OUT} = -5V$

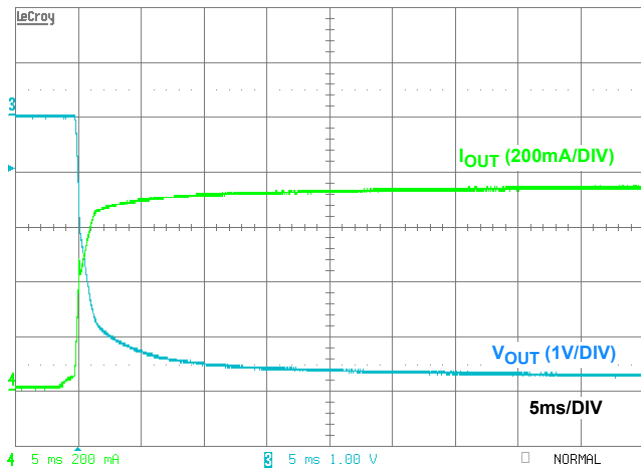

FIGURE 13. POWER ON INTO 0.76A LOAD, $V_{IN} = -12V$, $V_{OUT} = -5V$

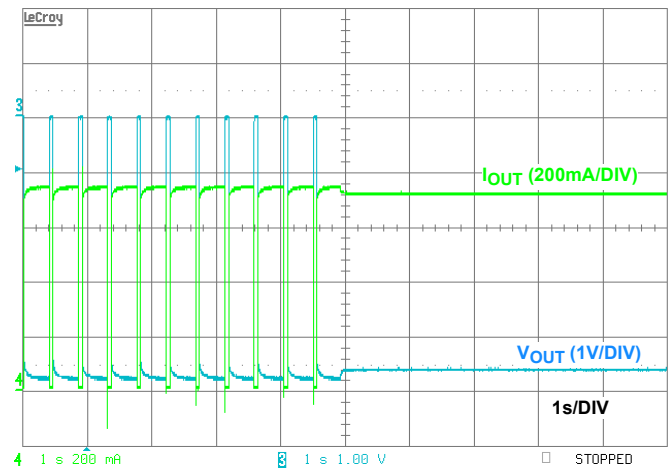

FIGURE 14. RECOVERY FROM OVER TEMPERATURE

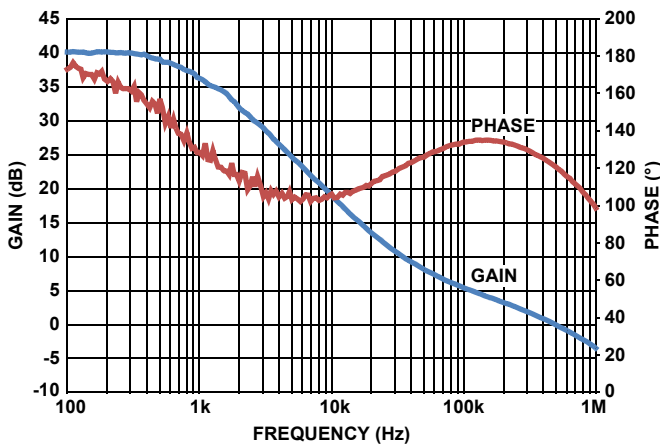

FIGURE 15. GAIN/PHASE $-12V_{IN}$, $-5V_{OUT}$, $0.5A I_{OUT}$

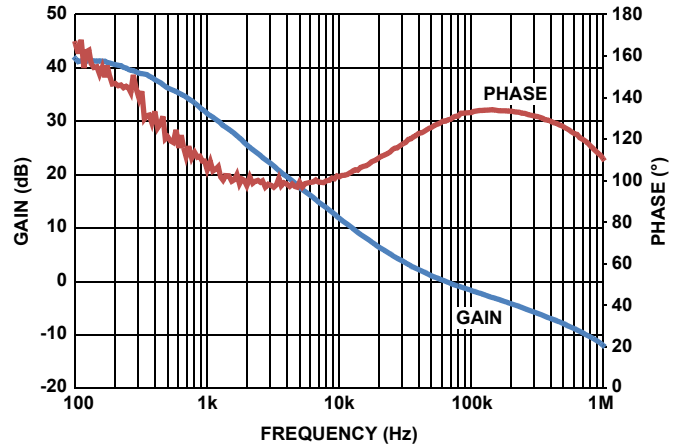

FIGURE 16. GAIN/PHASE $-20V_{IN}$, $-15V_{OUT}$, $0.5A I_{OUT}$

Notice

1. Descriptions of circuits, software and other related information in this document are provided only to illustrate the operation of semiconductor products and application examples. You are fully responsible for the incorporation or any other use of the circuits, software, and information in the design of your product or system. Renesas Electronics disclaims any and all liability for any losses and damages incurred by you or third parties arising from the use of these circuits, software, or information.
2. Renesas Electronics hereby expressly disclaims any warranties against and liability for infringement or any other claims involving patents, copyrights, or other intellectual property rights of third parties, by or arising from the use of Renesas Electronics products or technical information described in this document, including but not limited to, the product data, drawings, charts, programs, algorithms, and application examples.
3. No license, express, implied or otherwise, is granted hereby under any patents, copyrights or other intellectual property rights of Renesas Electronics or others.
4. You shall not alter, modify, copy, or reverse engineer any Renesas Electronics product, whether in whole or in part. Renesas Electronics disclaims any and all liability for any losses or damages incurred by you or third parties arising from such alteration, modification, copying or reverse engineering.
5. Renesas Electronics products are classified according to the following two quality grades: "Standard" and "High Quality". The intended applications for each Renesas Electronics product depends on the product's quality grade, as indicated below.
"Standard": Computers; office equipment; communications equipment; test and measurement equipment; audio and visual equipment; home electronic appliances; machine tools; personal electronic equipment; industrial robots; etc.
"High Quality": Transportation equipment (automobiles, trains, ships, etc.); traffic control (traffic lights); large-scale communication equipment; key financial terminal systems; safety control equipment; etc.
Unless expressly designated as a high reliability product or a product for harsh environments in a Renesas Electronics data sheet or other Renesas Electronics document, Renesas Electronics products are not intended or authorized for use in products or systems that may pose a direct threat to human life or bodily injury (artificial life support devices or systems; surgical implantations; etc.), or may cause serious property damage (space system; undersea repeaters; nuclear power control systems; aircraft control systems; key plant systems; military equipment; etc.). Renesas Electronics disclaims any and all liability for any damages or losses incurred by you or any third parties arising from the use of any Renesas Electronics product that is inconsistent with any Renesas Electronics data sheet, user's manual or other Renesas Electronics document.
6. When using Renesas Electronics products, refer to the latest product information (data sheets, user's manuals, application notes, "General Notes for Handling and Using Semiconductor Devices" in the reliability handbook, etc.), and ensure that usage conditions are within the ranges specified by Renesas Electronics with respect to maximum ratings, operating power supply voltage range, heat dissipation characteristics, installation, etc. Renesas Electronics disclaims any and all liability for any malfunctions, failure or accident arising out of the use of Renesas Electronics products outside of such specified ranges.
7. Although Renesas Electronics endeavors to improve the quality and reliability of Renesas Electronics products, semiconductor products have specific characteristics, such as the occurrence of failure at a certain rate and malfunctions under certain use conditions. Unless designated as a high reliability product or a product for harsh environments in a Renesas Electronics data sheet or other Renesas Electronics document, Renesas Electronics products are not subject to radiation resistance design. You are responsible for implementing safety measures to guard against the possibility of bodily injury, injury or damage caused by fire, and/or danger to the public in the event of a failure or malfunction of Renesas Electronics products, such as safety design for hardware and software, including but not limited to redundancy, fire control and malfunction prevention, appropriate treatment for aging degradation or any other appropriate measures. Because the evaluation of microcomputer software alone is very difficult and impractical, you are responsible for evaluating the safety of the final products or systems manufactured by you.
8. Please contact a Renesas Electronics sales office for details as to environmental matters such as the environmental compatibility of each Renesas Electronics product. You are responsible for carefully and sufficiently investigating applicable laws and regulations that regulate the inclusion or use of controlled substances, including without limitation, the EU RoHS Directive, and using Renesas Electronics products in compliance with all these applicable laws and regulations. Renesas Electronics disclaims any and all liability for damages or losses occurring as a result of your noncompliance with applicable laws and regulations.
9. Renesas Electronics products and technologies shall not be used for or incorporated into any products or systems whose manufacture, use, or sale is prohibited under any applicable domestic or foreign laws or regulations. You shall comply with any applicable export control laws and regulations promulgated and administered by the governments of any countries asserting jurisdiction over the parties or transactions.
10. It is the responsibility of the buyer or distributor of Renesas Electronics products, or any other party who distributes, disposes of, or otherwise sells or transfers the product to a third party, to notify such third party in advance of the contents and conditions set forth in this document.
11. This document shall not be reprinted, reproduced or duplicated in any form, in whole or in part, without prior written consent of Renesas Electronics.
12. Please contact a Renesas Electronics sales office if you have any questions regarding the information contained in this document or Renesas Electronics products.
(Note 1) "Renesas Electronics" as used in this document means Renesas Electronics Corporation and also includes its directly or indirectly controlled subsidiaries.
(Note 2) "Renesas Electronics product(s)" means any product developed or manufactured by or for Renesas Electronics.

(Rev.4.0-1 November 2017)



SALES OFFICES

Renesas Electronics Corporation

<http://www.renesas.com>

Refer to "<http://www.renesas.com/>" for the latest and detailed information.

Renesas Electronics America Inc.
1001 Murphy Ranch Road, Milpitas, CA 95035, U.S.A.
Tel: +1-408-432-8888, Fax: +1-408-434-5351

Renesas Electronics Canada Limited
9251 Yonge Street, Suite 8309 Richmond Hill, Ontario Canada L4C 9T3
Tel: +1-905-237-2004

Renesas Electronics Europe Limited
Dukes Meadow, Millboard Road, Bourne End, Buckinghamshire, SL8 5FH, U.K
Tel: +44-1628-651-700, Fax: +44-1628-651-804

Renesas Electronics Europe GmbH
Arcadiastrasse 10, 40472 Düsseldorf, Germany
Tel: +49-211-6503-0, Fax: +49-211-6503-1327

Renesas Electronics (China) Co., Ltd.
Room 1709 Quantum Plaza, No.27 ZhichunLu, Haidian District, Beijing, 100191 P. R. China
Tel: +86-10-8235-1155, Fax: +86-10-8235-7679

Renesas Electronics (Shanghai) Co., Ltd.
Unit 301, Tower A, Central Towers, 555 Langao Road, Putuo District, Shanghai, 200333 P. R. China
Tel: +86-21-2226-0888, Fax: +86-21-2226-0999

Renesas Electronics Hong Kong Limited
Unit 1601-1611, 16/F., Tower 2, Grand Century Place, 193 Prince Edward Road West, Mongkok, Kowloon, Hong Kong
Tel: +852-2265-6688, Fax: +852-2886-9022

Renesas Electronics Taiwan Co., Ltd.
13F, No. 363, Fu Shing North Road, Taipei 10543, Taiwan
Tel: +886-2-8175-9600, Fax: +886-2-8175-9670

Renesas Electronics Singapore Pte. Ltd.
80 Bendemeer Road, Unit #06-02 Hyflux Innovation Centre, Singapore 339949
Tel: +65-6213-0200, Fax: +65-6213-0300

Renesas Electronics Malaysia Sdn.Bhd.
Unit 1207, Block B, Menara Amcorp, Amcorp Trade Centre, No. 18, Jln Persiaran Barat, 46050 Petaling Jaya, Selangor Darul Ehsan, Malaysia
Tel: +60-3-7955-9390, Fax: +60-3-7955-9510

Renesas Electronics India Pvt. Ltd.
No.777C, 100 Feet Road, HAL 2nd Stage, Indiranagar, Bangalore 560 038, India
Tel: +91-80-67208700, Fax: +91-80-67208777

Renesas Electronics Korea Co., Ltd.
17F, KAMCO Yangjae Tower, 262, Gangnam-daero, Gangnam-gu, Seoul, 06265 Korea
Tel: +82-2-558-3737, Fax: +82-2-558-5338