

ISL73847SEHDEMO5Z

The ISL73847SEHDEMO5Z demonstration board demonstrates the performance of the [ISL73847SEH](#) dual-phase buck controller in single-phase mode. The board is optimized for a 4.5V to 15V input operation to generate a 25A max, 1V output.

Features

- Power-Good LED indicator
- Integrated LDO (VCC)
- Droop regulation set by a single resistor

Specifications

- Input voltage supply (V_{IN}): 4.5V to 15V
- Preset output voltage (V_{OUT}): 1V
- Preset switching frequency: 500kHz
- Maximum load current: 25A
- Preset droop regulation

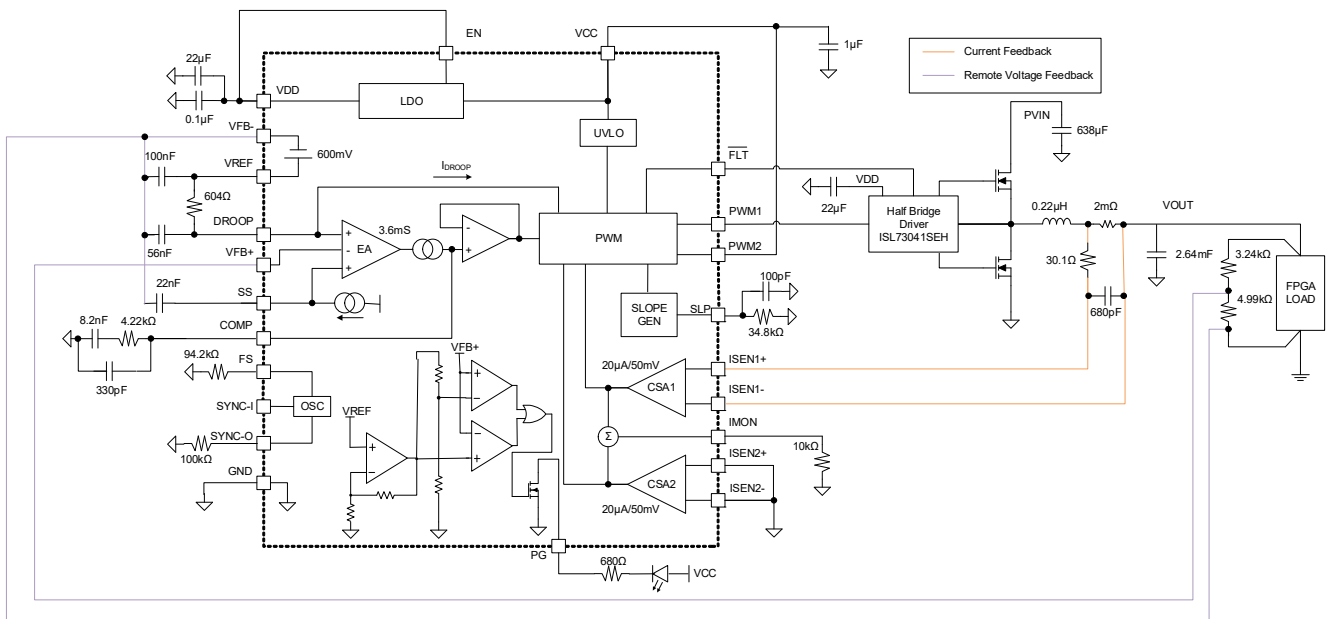

Figure 1. Block Diagram

Contents

1. Functional Description	3
1.1 Operating Range	3
1.2 Before Starting	3
1.3 Quick-Start Guide	3
1.4 Changing the Switching Frequency	4
1.5 Soft-Start Adjustment	4
1.6 Droop Regulation	4
1.7 Enabling/Disabling	4
2. Board Design	5
2.1 Layout Guidelines	5
2.2 Schematic Diagrams	6
2.3 Bill of Materials	7
2.4 Board Layout	10
3. Typical Performance Graphs	15
4. Ordering Information	16
5. Revision History	16

1. Functional Description

1.1 Operating Range

The ISL73847SEHDEMO5Z board requires one input supply (V_{IN}) to operate properly. This supply powers the ISL73847SEH controller analog supply input, plus additional supporting circuitry and the onboard buck power supply input. The user can set the V_{IN} supply from 4.5V to 15V. The buck regulator circuit is preset for a 1V output voltage and a switching frequency 500kHz with a 0.22 μ H output inductor and 2.64mF output capacitance.

1.2 Before Starting

The board does not come with any connectors. To properly use the board, solder connectors to the VIN, GND, and VOUT solder pads.

1.3 Quick-Start Guide

1. Apply a 4.5V to 15V voltage to VIN connectors, as shown in Figure 2. To use 4w sense lines from a power supply or a voltmeter to monitor the input voltage, solder a jumper to TP1.
2. If required, a resistor or electronic load can be connected to the VOUT connectors, as shown in Figure 2. To use 4w sense lines from an electronic load, solder a jumper to TP2.

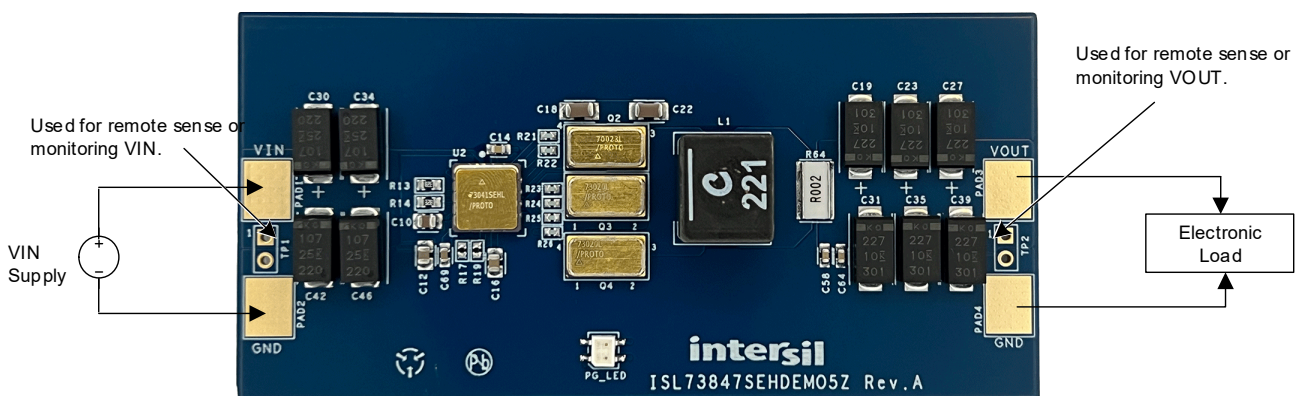

Figure 2. ISL73847SEHDEMO5Z Board Setup

1.4 Changing the Switching Frequency

The ISL73847SEHDEMO5Z is configured for a 500kHz switching frequency by a 94.2k Ω pull-down resistor (R_2) on the FS pin. The demonstration board includes a 0.22 μ H inductor and an array of output bypass capacitors for a 2.64mF output capacitance, which makes up the LC filter. If a different switching frequency is needed, see [Figure 3](#) for choosing the appropriate R_2 value on FS. For more information about the FS pin, refer to the *ISL73847SEH datasheet*.

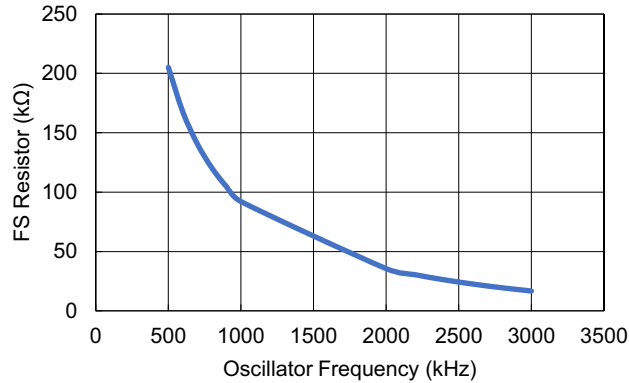

Figure 3. R_{FS} vs Frequency

1.5 Soft-Start Adjustment

The ISL73847SEHDEMO5Z is configured for a 2ms soft-start (SS) time by a 22nF bypass capacitor (C_2) connected to the SS pin. The SS time can be adjusted from 2ms to 200ms by changing the C_2 capacitor. If a different soft-start time is needed, use the C_{SS} equation in the *ISL73847SEH datasheet* to calculate the capacitance given the required soft-start time. For more information on SS, refer to the *ISL73847SEH datasheet*.

1.6 Droop Regulation

The ISL73847SEHDEMO5Z minimizes peak-to-peak transient response excursions using a 604 Ω resistor (R_1) connected between the VREF and DROOP pins. If droop regulation is unnecessary, replace the 604 Ω with a 0 Ω resistor to short the VREF and DROOP pins together. For more information about the droop regulation, refer to the *ISL73847SEH datasheet*.

1.7 Enabling/Disabling

The ISL73847SEHDEMO5Z automatically enables when VDD reaches a certain voltage on power-up by a 4.99k Ω resistor (R_6) connected between EN and VDD. For more information about enabling and disabling the controller, refer to the *ISL73847SEH datasheet*.

2. Board Design

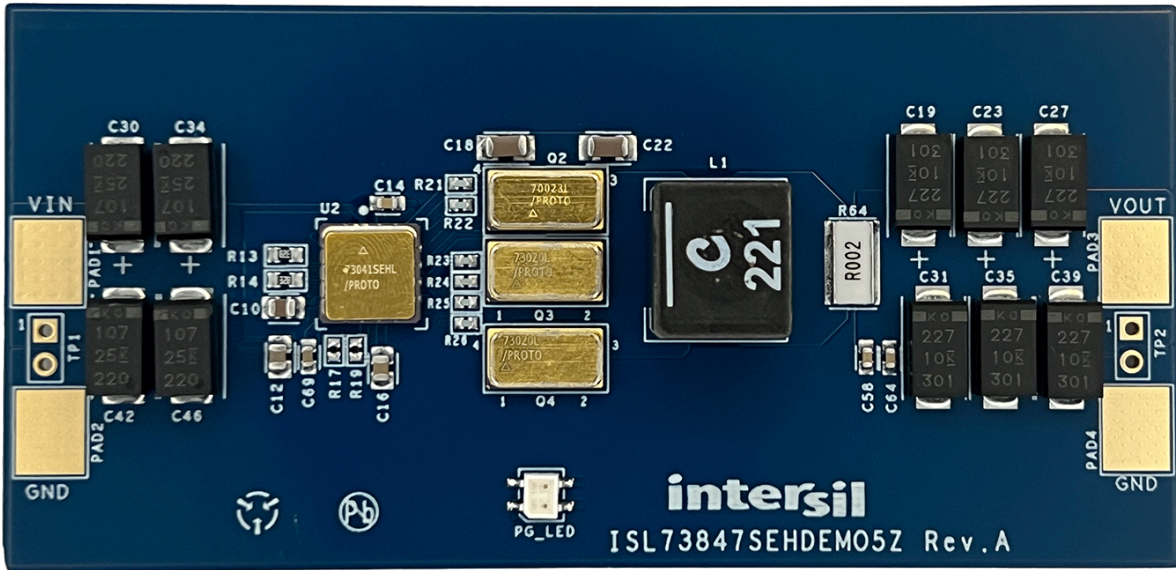

Figure 4. ISL73847SEHDEMO5Z Evaluation Board (Top)

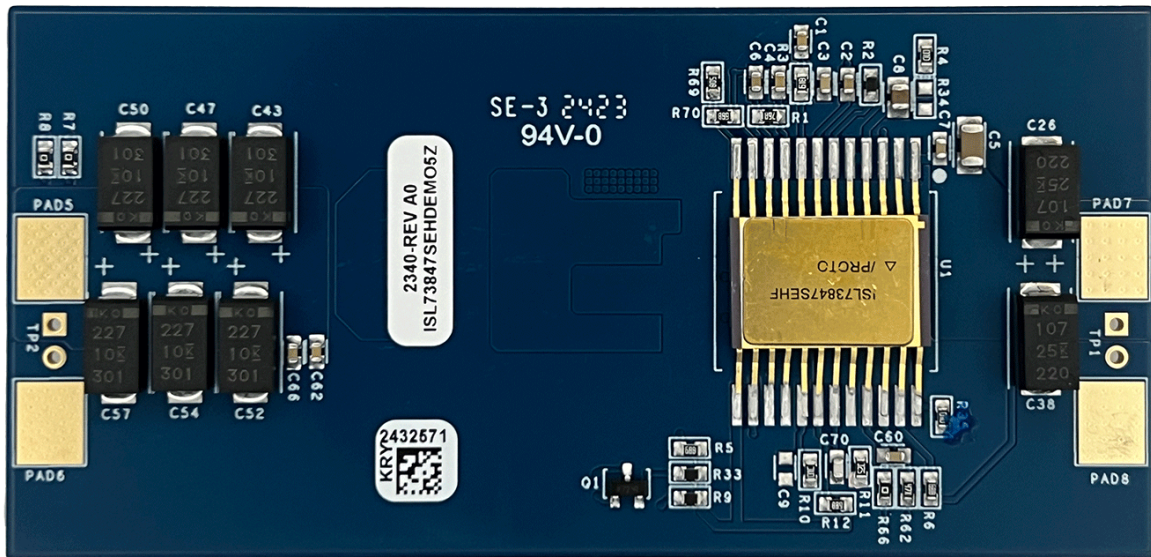

Figure 5. ISL73847SEHDEMO5Z Evaluation Board (Bottom)

2.1 Layout Guidelines

For detailed information about layout guidelines, refer to the *ISL73847SEH Datasheet*.

2.2 Schematic Diagrams

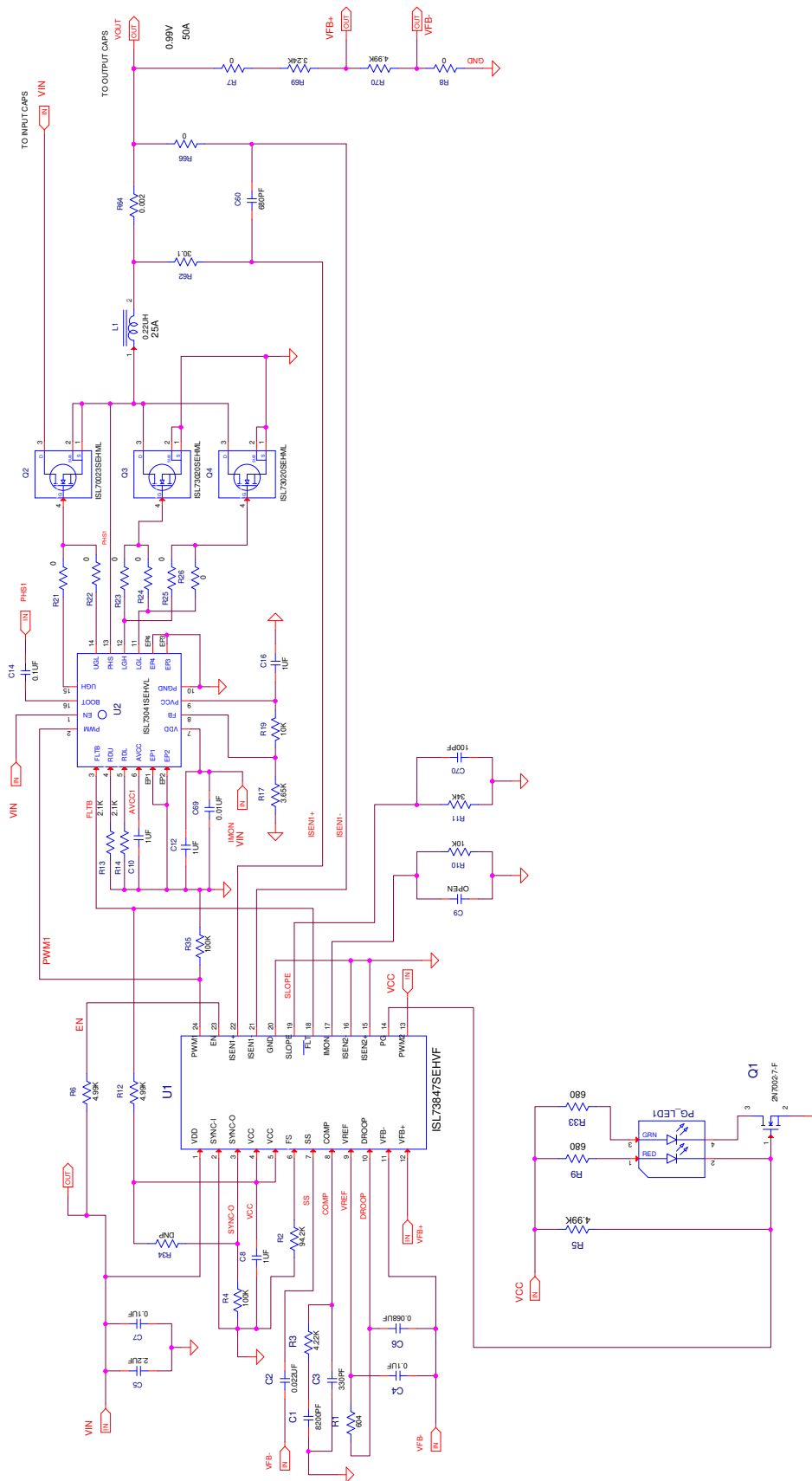

Figure 6. ISL73847SEHDEMO5Z Schematic Page 1

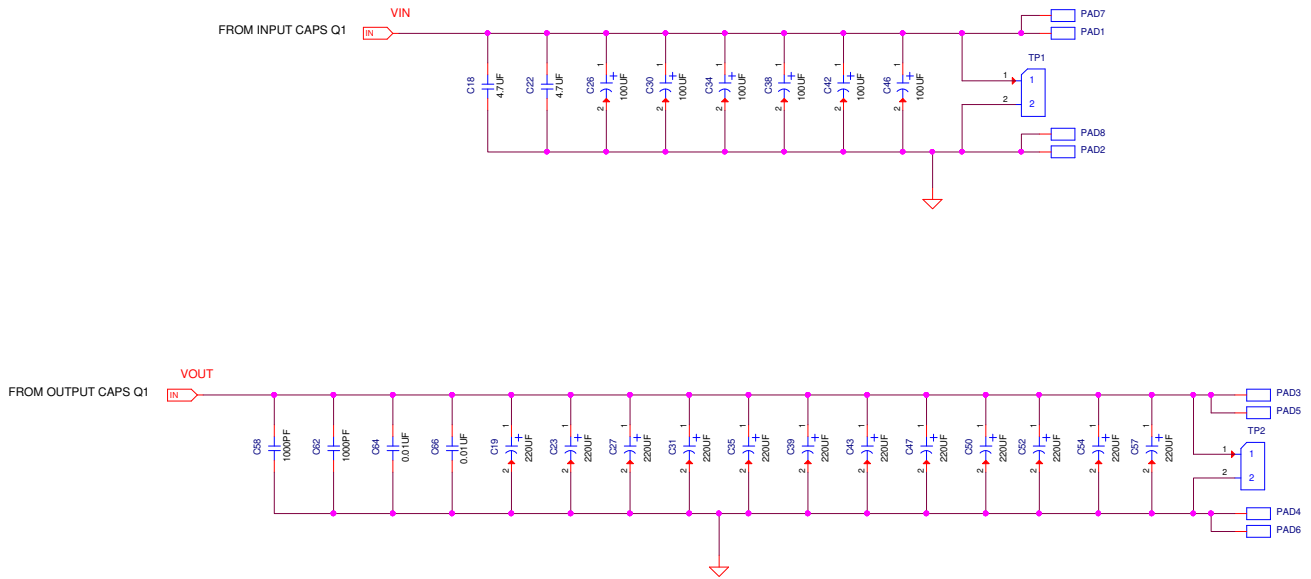

Figure 7. ISL73847SEHDEMO5Z Schematic Page 2

2.3 Bill of Materials

Qty	Reference Designator	Description	Manufacturer	Manufacturer Part
1	-	PWB-PCB, ISL73847SEHDEMO5Z, REVA, ROHS	Imagineering Inc	ISL73847SEHDEMO5ZREVAPCB
2	C58, C62	CAP, SMD, 0603, 1000pF, 16V, 10%, X7R, ROHS	AVX	0603YC102KAT2A
2	C8, C10	CAP, SMD, 0805, 1.0µF, 25V, 10%, X7R, ROHS	TDK	C2012X7R1E105K125AB
2	C18, C22	CAP, SMD, 1206, 4.7µF, 25V, 10%, X7R, ROHS	TDK	C3216X7R1E475K
2	C64, C66	CAP, SMD, 0603, 0.01µF, 16V, 10%, X7R, ROHS	Yageo	CC0603KRX7R7BB103
1	C2	CAP, SMD, 0603, 0.022µF, 16V, 10%, X7R, ROHS	Yageo	CC0603KRX7R7BB223
1	C70	CAP, SMD, 0603, 100pF, 25V, 10%, X7R, ROHS	Yageo	CC0603KRX7R8BB101
2	C4, C14	CAP, SMD, 0603, 0.1µF, 25V, 10%, X7R, ROHS	Yageo	CC0603KRX7R8BB104
1	C7	CAP, SMD, 0603, 0.1µF, 50V, 10%, X7R, ROHS	Yageo	CC0603KRX7R9BB104
1	C3	CAP, SMD, 0603, 330pF, 50V, 10%, X7R, ROHS	Yageo	CC0603KRX7R9BB331
1	C60	CAP, SMD, 0603, 680pF, 50V, 10%, X7R, ROHS	Yageo	CC0603KRX7R9BB681
1	C6	CAP, SMD, 0603, 0.068µF, 50V, 10%, X7R, ROHS	Yageo	CC0603KRX7R9BB683

Qty	Reference Designator	Description	Manufacturer	Manufacturer Part
2	C12, C16	CAP, SMD, 0805, 1.0 μ F, 25V, 10%, X7R, ROHS	Samsung	CL21B105KAFNNNE
1	C5	CAP-AEC-Q200, SMD, 1206, 2.2 μ F, 25V, 10%, X7R, ROHS	Murata	GCJ31MR71E225KA12L
1	C69	CAP, SMD, 0603, 0.01 μ F, 25V, 10%, X7R, ROHS	Murata	GRM188R71E103KA01D
0	C9	CAP, SMD, 0603, DNP-PLACE HOLDER, ROHS	-	-
6	C26, C30, C34, C38, C42, C46	CAP-TANT, SMD, 7.3 \times 4.3mm, 100 μ F, 25V, 20%, 30m Ω at 100MHz, ROHS	Kemet	T521X107M025ATE030
12	C19, C23, C27, C31, C35, C39, C43, C47, C50, C52, C54, C57	CAP-TANT, SMD, 7.3 \times 4.3 \times 2.8, 220 μ F, 10V, 20%, 6m Ω , ROHS	Kemet	T530D227M010ATE006
1	C1	CAP, SMD, 0603, 8200pF, 50V, 5%, X7R, ROHS	Vishay/Vitramon	VJ0603Y822JXACW1BC
1	L1	COIL-PWR INDUCT, AEC-Q200, SMD, 11.3 \times 10mm, 0.22 μ H, 20%, 98.8A, ROHS	Coilcraft	XAL1010-221MEB
1	PG_LED	LED, SMD, 3 \times 2.5mm, 4P, RED/GREEN, 12/20MCD, 2V	Lumex	SSL-LXA3025IGC-TR
1	Q2	IC-PROTO, 100V, RAD-HARD, GAN FET, SMD, 4P, CLCC, ROHS	Renesas Electronics	ISL70023SEHML/PROTO
2	Q3, Q4	IC-PROTO, RAD HARD, 40V GAN FET, 4P, CLCC, ROHS	Renesas Electronics	ISL73020SEHL/PROTO
1	U2	IC-RAD LIGHT GaNFET, HALF BRIDGE DRIVER, 14P, CLCC, ROHS	Renesas Electronics	ISL73041SEHL/PROTO
1	U1	IC-RAD LIGHT BUCK CONTROLLER, 24P, FP, ROHS	Renesas Electronics	ISL73847SEHF/PROTO
1	Q1	TRANSISTOR, N-CHANNEL, 3LD, SOT-23, 60V, 115mA, ROHS	Diodes, Inc.	2N7002-7-F
2	R9, R33	RES-AEC-Q200, SMD, 0603, 680 Ω , 1/10W, 1%, TF, ROHS	Vishay/Dale	CRCW0603680RFKEA
0	R34	RESISTOR, SMD, 0603, 0.1%, MF, DNP-PLACE HOLDER	-	-
1	R64	RES-AEC-Q200, SMD, 2512W, 0.002 Ω , 3W, 2%, MF, ROHS	Susumu CO., LTD	KRL6432E-M-R002-G-T1
6	R21-R26	RES, SMD, 0402, 0 Ω , 1/16W, 1%, THINFILM, ANTI-SULFER, ROHS	Vishay/BC Components	MCS04020Z0000ZE000
1	R17	RES, SMD, 0402, 3.65K, 1/16W, 1%, TF, ROHS	Yageo	RC0402FR-073K65L
2	R4, R35	RES, SMD, 0603, 100K, 1/10W, 1%, TF, ROHS	Yageo	RC0603FR-07100KL

Qty	Reference Designator	Description	Manufacturer	Manufacturer Part
1	R10	RES, SMD, 0603, 10K, 1/10W, 1%, TF, ROHS	Yageo	RC0603FR-0710KL
2	R13, R14	RES, SMD, 0603, 2.1K, 1/10W, 1%, TF, ROHS	Yageo	RC0603FR-072K1L
1	R62	RES, SMD, 0603, 30.1Ω, 1/10W, 1%, TF, ROHS	Yageo	RC0603FR-0730R1L
1	R11	RES, SMD, 0603, 34K, 1/10W, 1%, TF, ROHS	Yageo	RC0603FR-0734KL
1	R69	RES, SMD, 0603, 3.24K, 1/10W, 1%, TF, ROHS	Yageo	RC0603FR-073K24L
1	R3	RES, SMD, 0603, 4.22K, 1/10W, 1%, TF, ROHS	Yageo	RC0603FR-074K22L
4	R5, R6, R12, R70	RES, SMD, 0603, 4.99K, 1/10W, 1%, TF, ROHS	Yageo	RC0603FR-074K99L
1	R1	RES, SMD, 0603, 604Ω, 1/10W, 1%, TF, ROHS	Yageo	RC0603FR-07604RL
3	R7, R8, R66	RES, SMD, 0603, 0Ω, 1/10W, TF, ROHS	Yageo	RC0603JR-070RL
1	R19	RES-AEC-Q200, SMD, 0402, 10K, 1/16W, 1%, TF, ROHS	Stackpole	RMCF0402FT10K0
1	R2	RES, SMD, 0603, 94.2K, 1/10W, 0.1%, THINFILM, ROHS	Yageo	RT0603BRD0794K2L
0	PAD1-PAD8	DO NOT POPULATE OR PURCHASE	-	-
0	TP1, TP2	DO NOT POPULATE OR PURCHASE	-	-

2.4 Board Layout

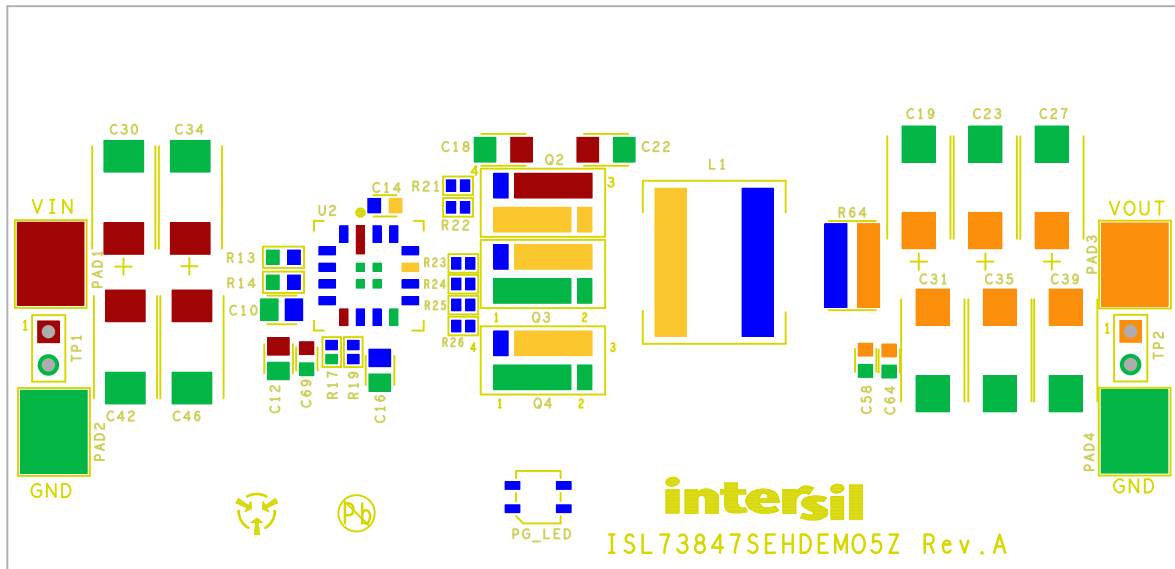

Figure 8. Silkscreen Top Layer

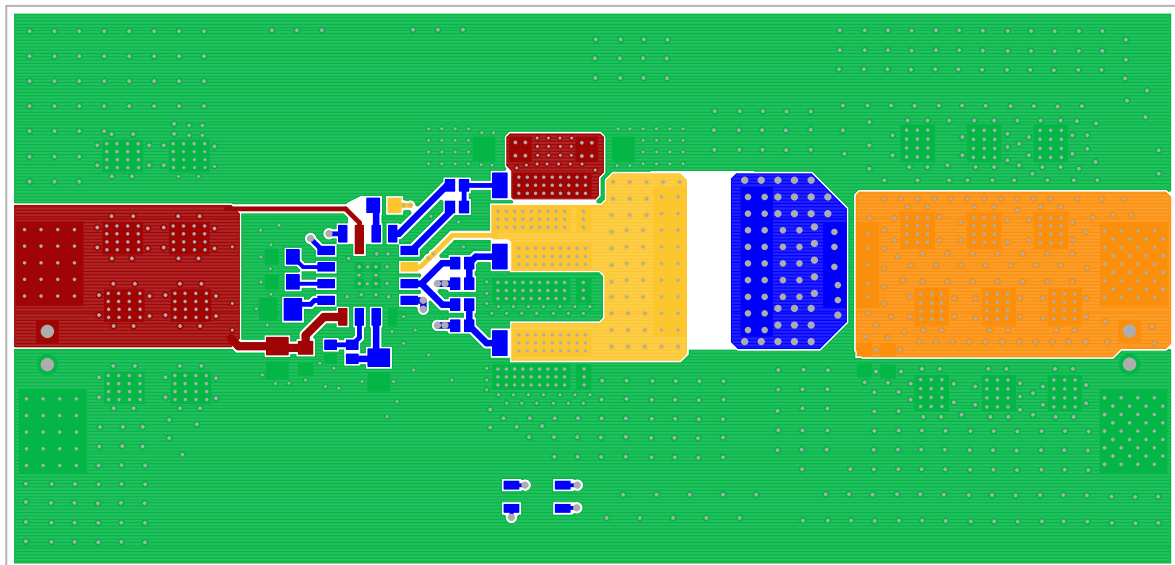

Figure 9. Top Layer

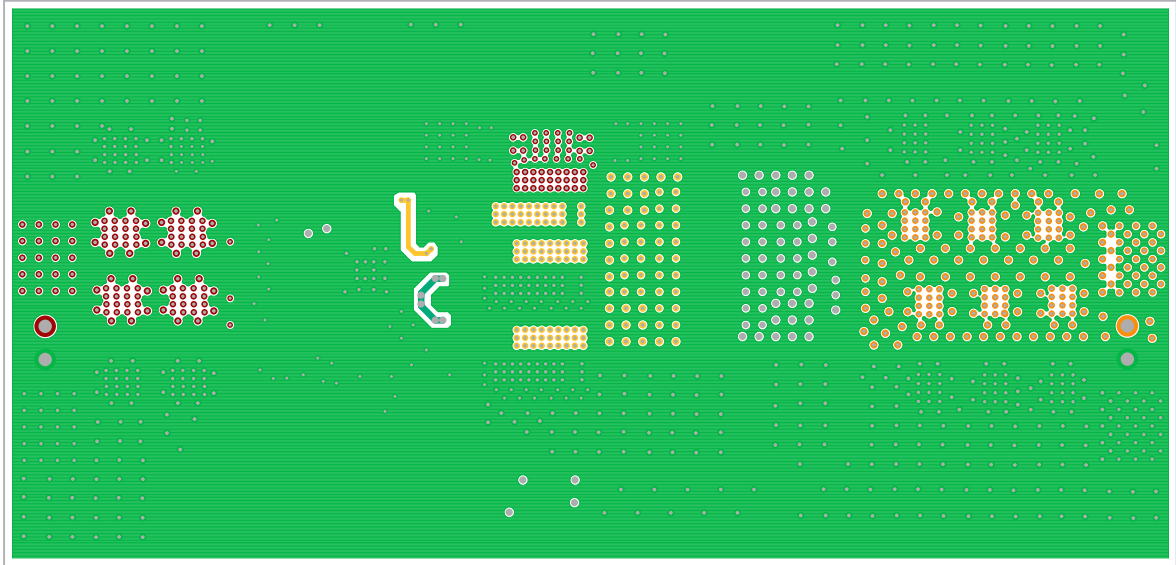

Figure 10. Layer 2

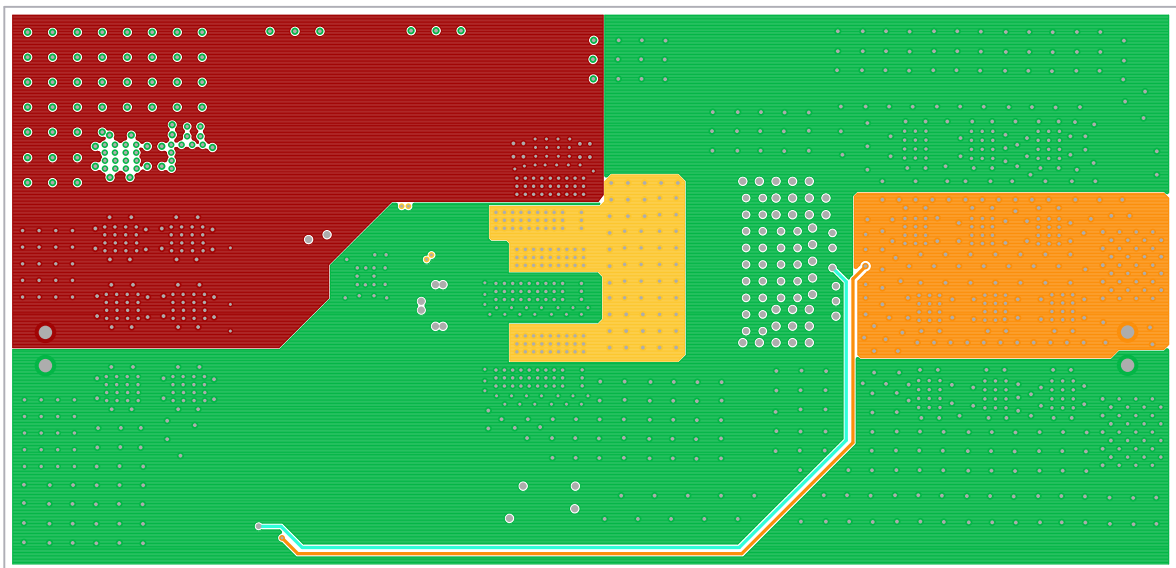

Figure 11. Layer 3

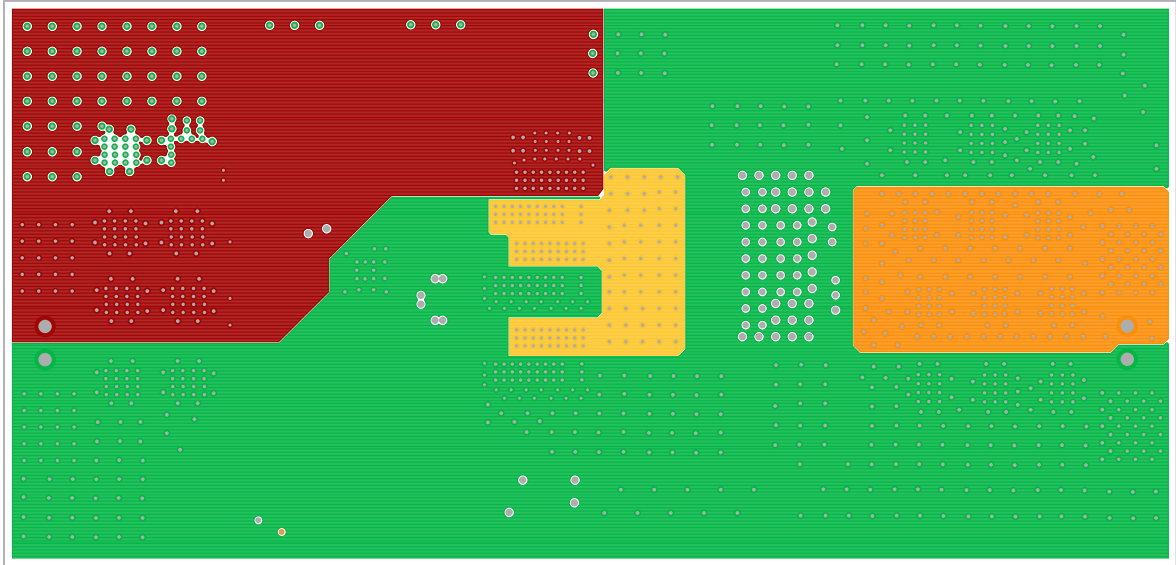

Figure 12. Layer 4

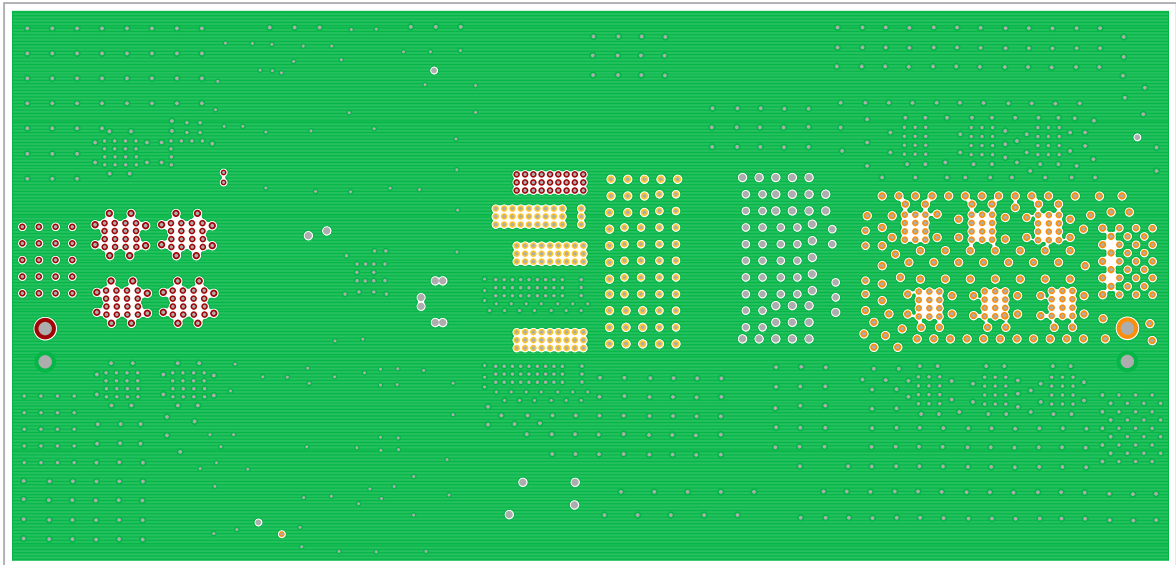

Figure 13. Layer 5

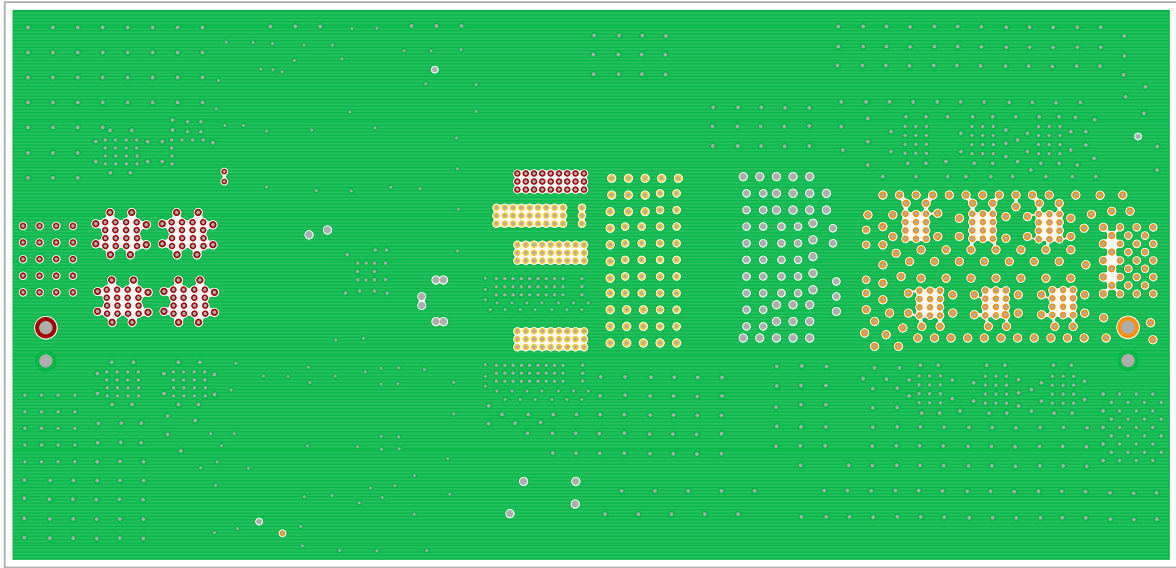

Figure 14. Layer 6

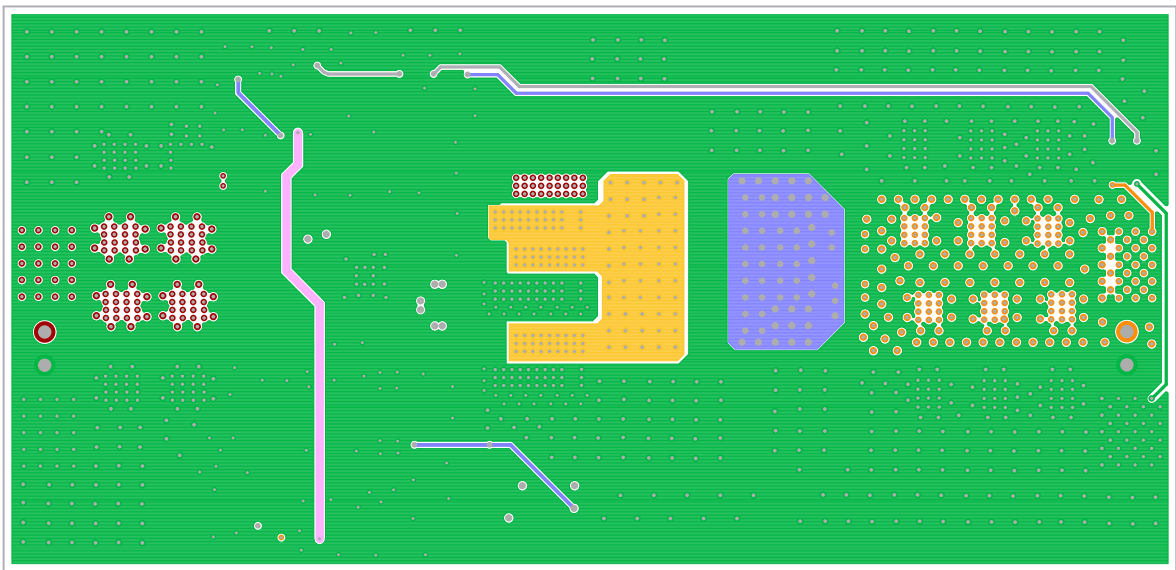

Figure 15. Layer 7

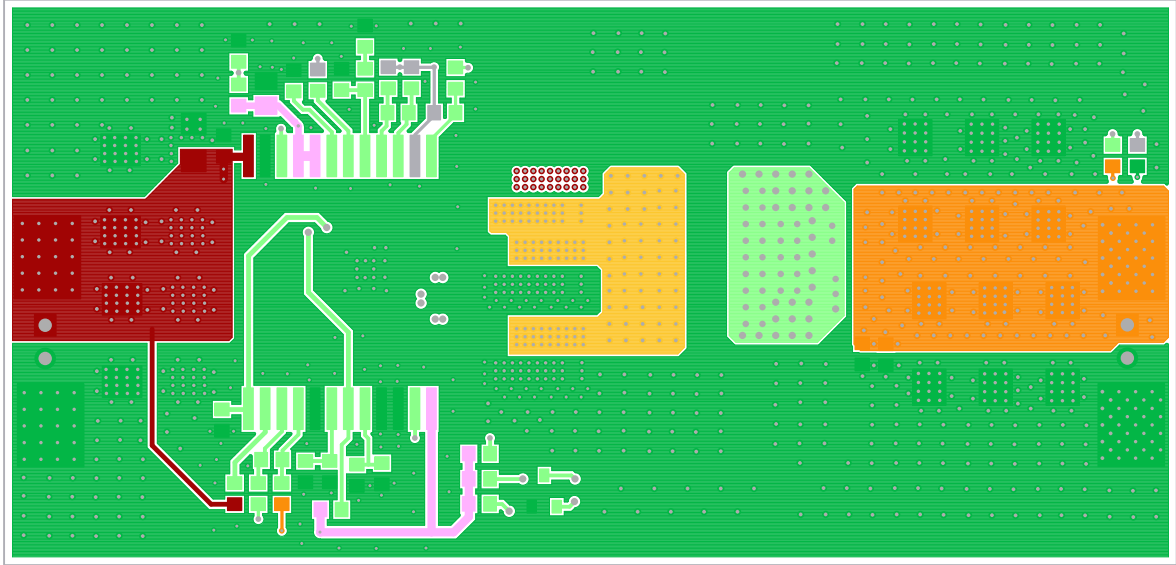

Figure 16. Bottom Layer

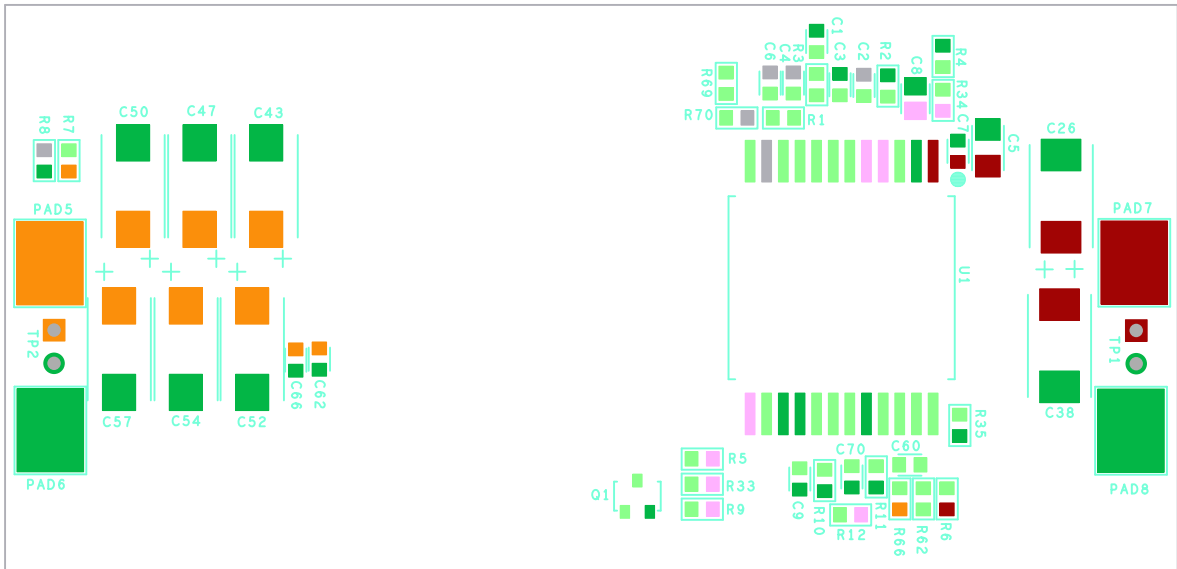

Figure 17. Silkscreen Bottom Layer

3. Typical Performance Graphs

Unless otherwise noted, $V_{OUT} = 1V$; $L_{OUT} = 220nH$, $C_{OUT} = 2.64mF$, $C_{DROOP} = 56nF$, $C_{VREF} = 100nF$, $R_{DROOP} = 604\Omega$, $R_{FS} = 94.2k\Omega$, $C_{SS} = 22nF$, $C_{COMP} = 8.2nF$, $R_{COMP} = 4.22k\Omega$, $C_{POLE} = 330pF$, $C_{VCC} = 1\mu F$, $R_{SLP} = 34.8k\Omega$, $C_{SLP} = 100pF$, $T_A = +25^\circ C$

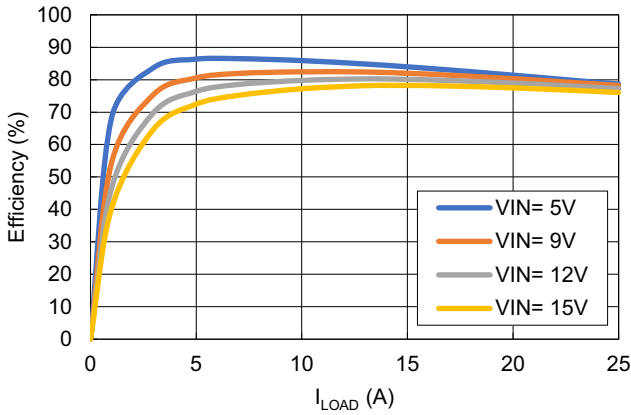

Figure 18. Conversion Efficiency for Various V_{IN}
($f_{SW} = 500kHz$)

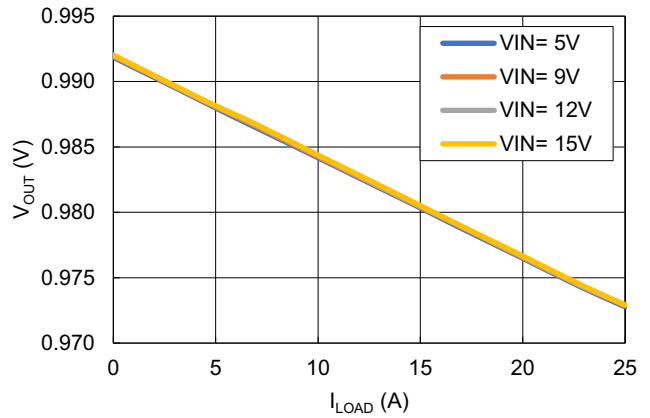

Figure 19. Droop Regulation for Various V_{IN}

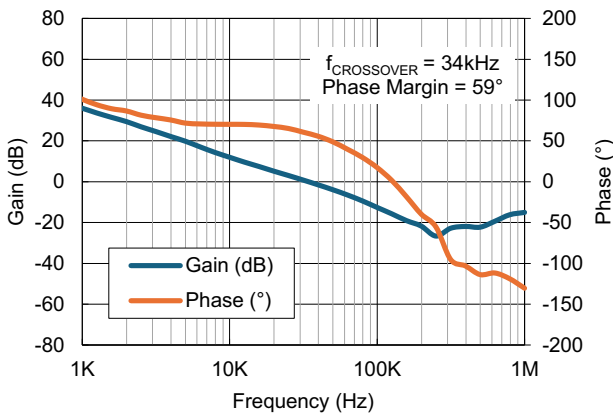

Figure 20. Gain and Phase vs Frequency ($V_{IN} = 5V$,
 $I_{LOAD} = 0A$, $f_{SW} = 500kHz$)

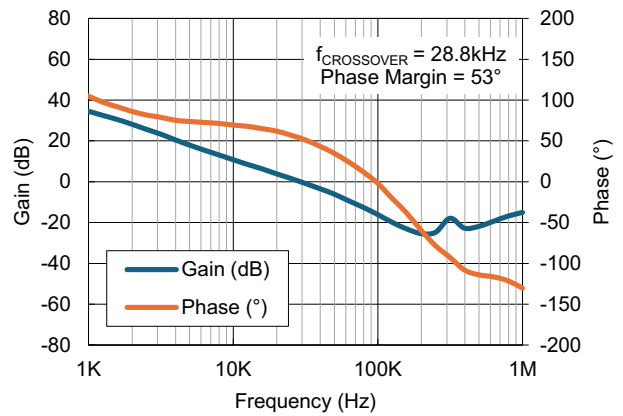

Figure 21. Gain and Phase vs Frequency ($V_{IN} = 12V$,
 $I_{LOAD} = 0A$, $f_{SW} = 500kHz$)

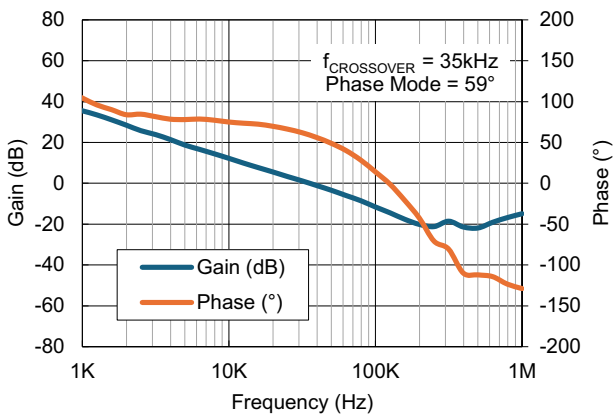

Figure 22. Gain and Phase vs Frequency ($V_{IN} = 5V$,
 $I_{LOAD} = 12.5A$, $f_{SW} = 500kHz$)

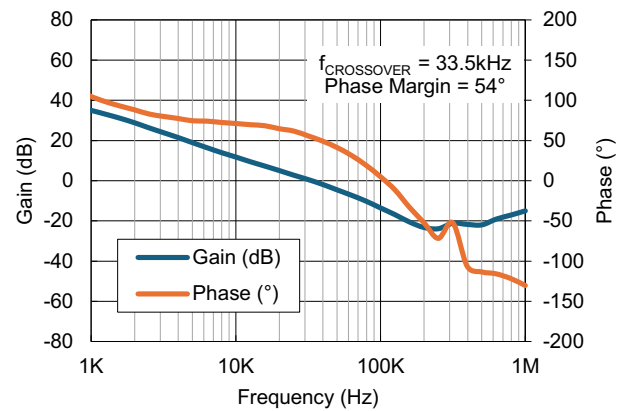

Figure 23. Gain and Phase vs Frequency ($V_{IN} = 12V$,
 $I_{LOAD} = 12.5A$, $f_{SW} = 500kHz$)

Unless otherwise noted, $V_{OUT} = 1V$; $L_{OUT} = 220nH$, $C_{OUT} = 2.64mF$, $C_{DROOP} = 56nF$, $C_{VREF} = 100nF$, $R_{DROOP} = 604\Omega$, $R_{FS} = 94.2k\Omega$, $C_{SS} = 22nF$, $C_{COMP} = 8.2nF$, $R_{COMP} = 4.22k\Omega$, $C_{POLE} = 330pF$, $C_{VCC} = 1\mu F$, $R_{SLP} = 34.8k\Omega$, $C_{SLP} = 100pF$, $T_A = +25^\circ C$

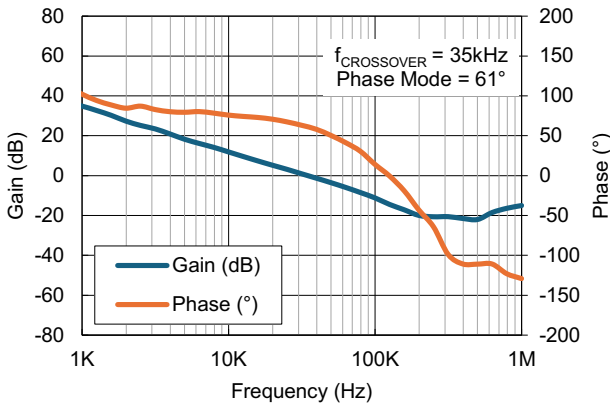

Figure 24. Gain and Phase vs Frequency ($V_{IN} = 5V$, $I_{LOAD} = 25A$, $f_{SW} = 500kHz$)

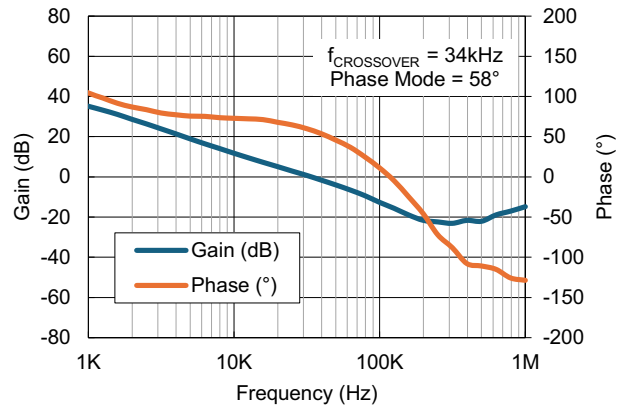

Figure 25. Gain and Phase vs Frequency ($V_{IN} = 12V$, $I_{LOAD} = 25A$, $f_{SW} = 500kHz$)

4. Ordering Information

Part Number	Description
ISL73847SEHDEMO5Z	ISL73847SEH demonstration board

5. Revision History

Revision	Date	Description
1.02	May 13, 2024	Added Phase Margin label to Figures 20 through 25.
1.01	Apr 24, 2024	Added Figures 20 through 25.
1.00	Nov 9, 2023	Initial release

IMPORTANT NOTICE AND DISCLAIMER

RENESAS ELECTRONICS CORPORATION AND ITS SUBSIDIARIES (“RENESAS”) PROVIDES TECHNICAL SPECIFICATIONS AND RELIABILITY DATA (INCLUDING DATASHEETS), DESIGN RESOURCES (INCLUDING REFERENCE DESIGNS), APPLICATION OR OTHER DESIGN ADVICE, WEB TOOLS, SAFETY INFORMATION, AND OTHER RESOURCES “AS IS” AND WITH ALL FAULTS, AND DISCLAIMS ALL WARRANTIES, EXPRESS OR IMPLIED, INCLUDING, WITHOUT LIMITATION, ANY IMPLIED WARRANTIES OF MERCHANTABILITY, FITNESS FOR A PARTICULAR PURPOSE, OR NON-INFRINGEMENT OF THIRD-PARTY INTELLECTUAL PROPERTY RIGHTS.

These resources are intended for developers who are designing with Renesas products. You are solely responsible for (1) selecting the appropriate products for your application, (2) designing, validating, and testing your application, and (3) ensuring your application meets applicable standards, and any other safety, security, or other requirements. These resources are subject to change without notice. Renesas grants you permission to use these resources only to develop an application that uses Renesas products. Other reproduction or use of these resources is strictly prohibited. No license is granted to any other Renesas intellectual property or to any third-party intellectual property. Renesas disclaims responsibility for, and you will fully indemnify Renesas and its representatives against, any claims, damages, costs, losses, or liabilities arising from your use of these resources. Renesas' products are provided only subject to Renesas' Terms and Conditions of Sale or other applicable terms agreed to in writing. No use of any Renesas resources expands or otherwise alters any applicable warranties or warranty disclaimers for these products.

(Disclaimer Rev.1.01 Jan 2024)

Corporate Headquarters

TOYOSU FORESIA, 3-2-24 Toyosu,
Koto-ku, Tokyo 135-0061, Japan
www.renesas.com

Trademarks

Renesas and the Renesas logo are trademarks of Renesas Electronics Corporation. All trademarks and registered trademarks are the property of their respective owners.

Contact Information

For further information on a product, technology, the most up-to-date version of a document, or your nearest sales office, please visit www.renesas.com/contact-us/.