

ISL76683EVAL1Z

ISL76683 Light-to-Digital Output Sensor Evaluation Hardware/Software
User Guide

AN1657
Rev 0.00
Aug 12, 2011

Description

The ISL76683EVAL1Z evaluation board is an RoHS compliant evaluation board designed for exploring the operation of the ISL76683 light-to-digital output sensor. The evaluation board is an easy-to-use platform for testing most of the specifications and functionalities described in the [ISL76683 datasheet](#).

Evaluation Package

- Demo Board (Evaluation Board ISL76683EVAL1Z and USB Board ISLUSBCEVAL1Z, REV A), populated with all required components
- USB 2.0 Cable
- Evaluation Software (see [“Tools and Support”](#) on [ISL76683 device information page](#))
- AN1657: “ISL76683 Light-to-Digital Output Sensor Evaluation Hardware/Software User Guide” (see [“Technical Documentation”](#) on [ISL76683 device information page](#))

System Requirements

- Windows 98/NT/2000/XP
- USB Port

Hardware Setup

The PC and printed circuit board (PCB) should not be connected via the USB until after the evaluation software has been installed satisfactorily (see “Software Setup” on page 2).

To set up the hardware:

1. Connect the USB 2.0 cable first to the PC and then to the evaluation board. The USB cable is the only connector needed.
2. If a dialog appears asking about installing software for new-found hardware, click “Yes, this time only”.

The jumpers on the printed circuit board (PCB) are as shown in Table 1.

TABLE 1. JUMPERS ON PCB

JUMPER	DESCRIPTION
J500K	Res = 500kΩ
J100K	Res = 100kΩ (Default)
J50K	Res = 50kΩ
VDD to 3.3V	Connect 3.3V rail to VDD

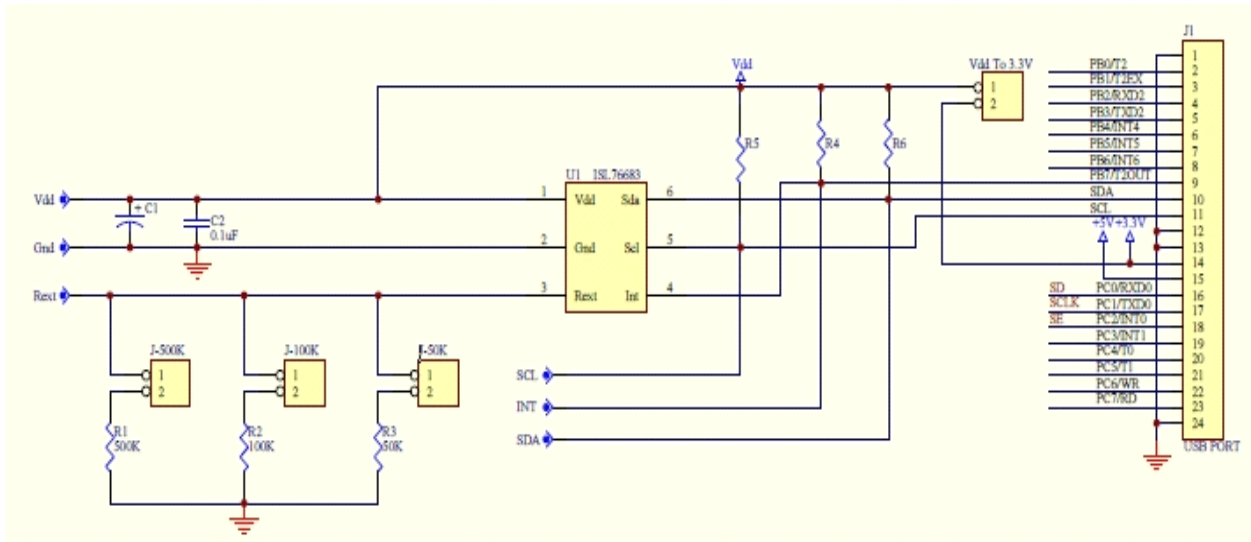

FIGURE 1. ISL76683EVAL1Z EVALUATION BOARD SCHEMATIC

Software Setup

Downloading the Software

On the [ISL76683 device information page](#), under “Tools and Support”, click [Intersil_ALS_ISL76683_Installer_V100.exe](#) to download the ISL76683 evaluation software installer file.

Firmware Reference

The installer file has Human Interface Device (HID) firmware in the microcontroller board, ISLUSBCEVAL1Z, REV A. The firmware allows the evaluation software to communicate with the ISL76683 evaluation board through a PC operating on Windows 98/NT/2000/XP.

Installing the Software

Download and run [Intersil_ALS_ISL76683_Installer_V100.exe](#). The dialog shown in Figure 2 appears. Follow the instructions on each screen for installing the software. The PC and PCB should not be connected via the USB until after the installation has completed satisfactorily.

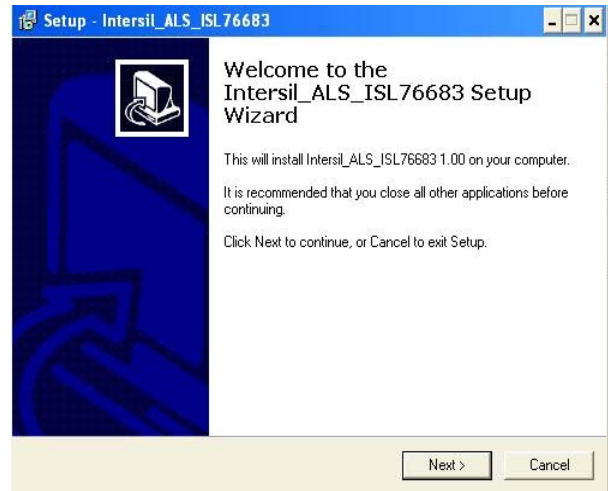

FIGURE 2. SOFTWARE SETUP WIZARD

Running the Evaluation Software

To open the evaluation software program:

1. Click the **Start** menu and navigate to the software as follows: **Start -> All Programs -> Intersil -> Intersil_ALS_ISL76683 -> Intersil_ALS_ISL76683.**
2. Double-click the program name. The **Intersil Light Sensor Demo...** window shown in Figure 3 appears.
3. In the **Device Select** dropdown menu, select **ISL76683.**
4. The **ISL76683 Light Sensor Evaluation Software** window shown in Figure 4 opens. This window is the main interface for demonstrating the capabilities of ISL76683.

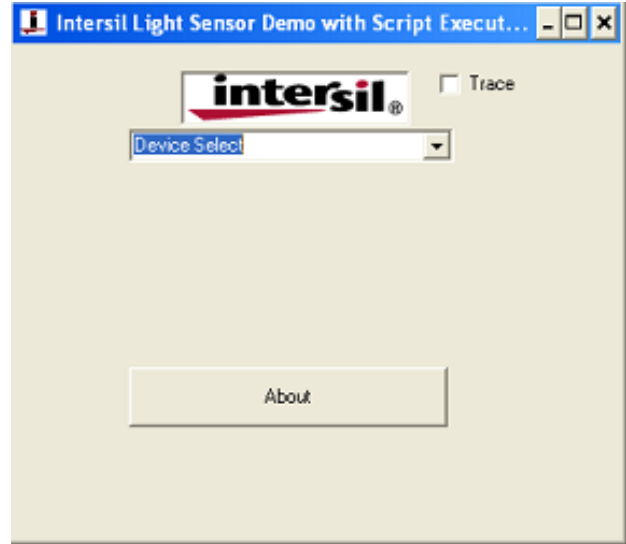

FIGURE 3. SOFTWARE STARTUP

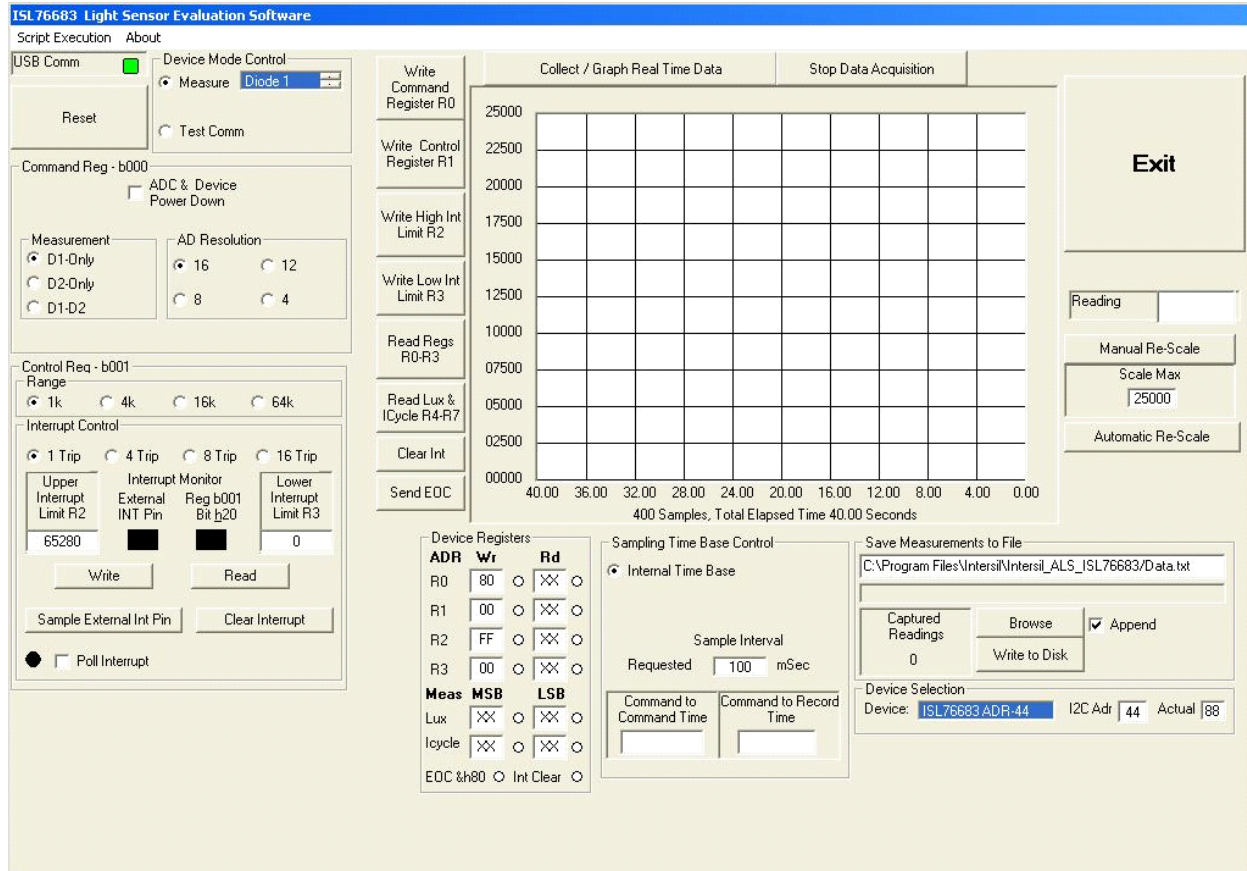

FIGURE 4. ISL76683 LIGHT SENSOR EVALUATION SOFTWARE USER INTERFACE

Using the ISL76683 Light Sensor Evaluation Software

USB Communications

In the upper left corner of the **ISL76683 Light Sensor Evaluation Software** window, in the **USB Comm** area, ensure that the light is green (Figure 5). If it is not green, check the USB cable connection.

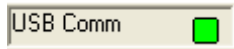

FIGURE 5. USB COMMUNICATIONS INDICATOR

Test Communications

In the upper left corner of the **ISL76683 Light Sensor Evaluation Software** window, in the **Device Mode Control** dialog area, click the **Test Comm** radio button to test communications between the PC and the evaluation board. If it shows **Good**, as shown in Figure 6, then the hardware and software are properly set up. If it shows **Fall**, check the connections between the PC and the board. If the problem persists, restart the software.

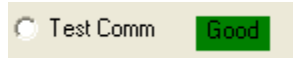

FIGURE 6. TEST COMMUNICATIONS

Device Registers

The **Device Registers** area (Figure 7) in the bottom center of the **ISL76683 Light Sensor Evaluation Software** window displays the current state of the device registers (Figure 7A). Use the column of buttons to the left of the **Collect/Graph Real Time Data** grid (top center) (Figure 7B) to read or write to the registers.

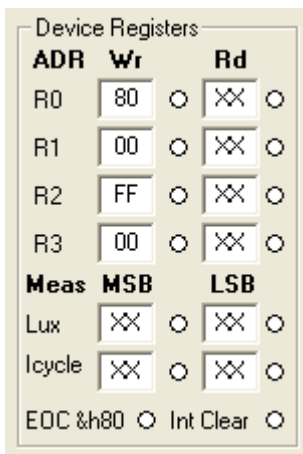

FIGURE 7A.

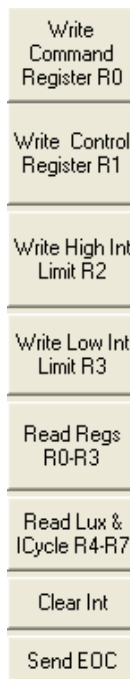

FIGURE 7B.

FIGURE 7. DEVICE REGISTERS STATUS, READ, AND WRITE

Command Register 00 (Hex)

ADC RESET AND DEVICE POWER-DOWN

In the upper left corner of the **ISL76683 Light Sensor Evaluation Software** window, in the **Command Reg - b000** dialog area, click the **ADC & Device Power Down** check box to disable and reset the ADC and to put the ISL76683 into power-down mode.



FIGURE 8. ADC RESET AND DEVICE POWER-DOWN

MEASUREMENT MODE SELECTION

The ISL76683 contains two photodiodes. Diode 1 is sensitive to both visible and infrared light, while Diode 2 is sensitive mostly to infrared light. Measurement Mode 1 is Diode 1 only, and Measurement Mode 2 is Diode 2 only. Measurement Mode 3 is a sequential Mode 1 and Mode 2, with an internal subtract function (Diode 1 - Diode 2).

You can select the measurement mode in one of two ways. In the upper left corner of the **ISL76683 Light Sensor Evaluation Software** window, in the **Device Mode Control** dialog area, click the **Measure** radio button, and from the scroll list, select the diode to be measured (Figure 9A). Or, in the **Command Reg - b000** dialog area, under **Measurement**, click one of three radio buttons to select the diode to measure (Figure 9B).



FIGURE 9A.

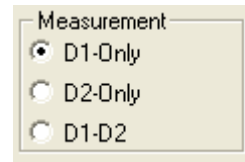

FIGURE 9B.

FIGURE 9. MEASUREMENT MODE SELECTION

AD RESOLUTION

Changing the number of clock cycles does more than just change the resolution of the device; it also changes the integration time, which is the period the device's analog-to-digital converter (ADC) samples the photodiode current signal for a lux measurement. To change the device resolution (and integration time), in the **Command Reg - b000** dialog area, under **AD Resolution**, click one of the four radio buttons to select the number of clock cycles per conversion.

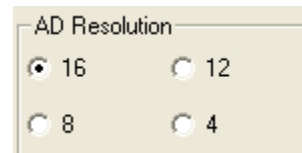

FIGURE 10. AD RESOLUTION SELECTION

Control Register 01 (Hex)

RANGE/GAIN SELECTION

The ADC has four I²C programmable range (gain) selections to dynamically accommodate various lighting conditions. For example, a very bright object requires a higher range (e.g., 64k) than a dark object, which requires a low range (e.g., 1k). Higher ranges reduce photo detector sensitivity. In the **ISL76683 Light Sensor Evaluation Software** window, in the **Control Reg - b001** dialog area, under **Range**, click one of the four radio buttons to select the range to match lighting conditions.

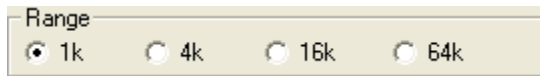

FIGURE 11. RANGE/GAIN SELECT

Interrupt Control Register 01 (Hex) and Threshold Registers 02 (Hex) and 03 (Hex)

Interrupt thresholds are stored in Registers 0x02 and 0x03. In the **Interrupt Control** dialog (Figure 12), enter values in the **Upper Interrupt Limit R2** and **Lower Interrupt Limit R3** text boxes and click **Write** to edit the interrupt thresholds. (See the [ISL76683 datasheet](#) for more information on interrupt limits.) The interrupt thresholds act as an alarm or monitoring function to determine whether the ADC count exceeds the upper or lower limit.

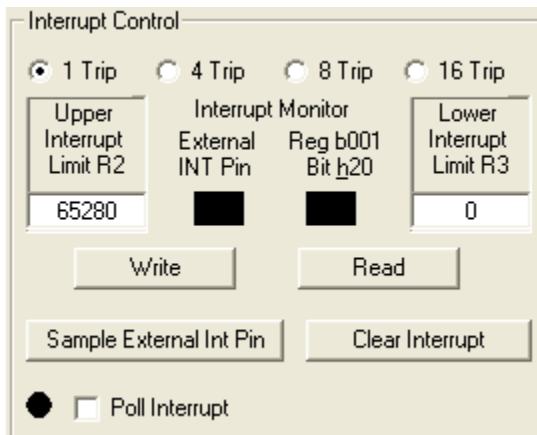

FIGURE 12. INTERRUPT CONTROL

To set the interrupt limits in the **Interrupt Control** dialog (see Table 2 for parameter descriptions):

1. Click one of the four radio buttons across the top of the dialog window to choose an interrupt persistence value (recommended value: 8 Trip).
2. Enter decimal values in the **Upper Interrupt Limit R2** and **Lower Interrupt Limit R3** text boxes. The upper limit must be greater than the lower limit. Values for the limits depend on the application, the configuration of other options, and the distance at which you choose to flag.
3. Click **Write** and then click **Read**. Verify the desired limit values by comparing the values entered for the intended limits to the values in the **Device Registers** dialog after clicking **Read**. If they do not match, repeat Steps 2 and 3.

4. Click **Clear Interrupt** to clear or reset the interrupt status bit.
5. You can manually poll the Interrupt pin (Pin 4 on the ISL76683EVAL1Z evaluation board) or you can set it to be polled automatically. To poll it manually, click **Sample External Int Pin**. To poll it automatically, click the **Poll Interrupt** check box to select it.

With interrupt limits set, you can begin collecting data. Data is collected within the upper and lower limits you selected. In the **Interrupt Control** dialog, in the **Interrupt Monitor** area, black boxes indicate an unflagged status that is within limits. Red boxes indicate the data collected is either above the upper limit or below the lower limit and that the interrupt flag has been triggered.

TABLE 2. INTERRUPT CONTROL PARAMETERS

PARAMETER	DESCRIPTION
Interrupt Persistence	Sets the number of times the upper limit is exceeded or lower limit is subceeded before an alarm or interrupt flag is raised.
Upper Interrupt Limit R2	Applies to Interrupt Threshold HI Register 0x02. This register sets the HI threshold for the Interrupt pin and the interrupt flag. By default, the interrupt threshold HI is FF (hex). The 8-bit data written to the register represents the upper MSB of a 16-bit value. The LSB is always 00 (hex).
Lower Interrupt Limit R3	Applies to Interrupt Threshold LO Register 0x03. This register sets the LO threshold for the Interrupt pin and the interrupt flag. By default, the Interrupt threshold LO is 00 (hex). The 8-bit data written to the register represents the upper MSB of a 16-bit value. The LSB is always 00 (hex).
Write, Read	Store or read values in the upper and lower interrupt limit threshold Registers 0x02 and 0x03.
Clear Interrupt	Click Clear Interrupt to clear or reset the interrupt status bit.
Sample External Int Pin	Manually sample the external interrupt pin (Pin 4) on the IC.
Poll Interrupt	Allows checking of the external interrupt status while sampling data.
Interrupt Monitor	<ul style="list-style-type: none"> • Square indicator light displays status: black means no fault; red means an interrupt fault. • Monitor external interrupt pin manually by clicking Sample External Int Pin button or automatically by clicking Poll Interrupt check box to select it. Reg b001, Bit h20, can only be monitored manually.

Data Collection

In the **ISL76683 Light Sensor Evaluation Software** window, use the **Collect/Graph Real Time Data** dialog (Figure 13) to acquire and graph measurements.

- Click **Collect/Graph Real Time Data** to sample data. Samples are taken and plotted, and values are displayed in the **Reading** field on the right side of the dialog. The **Reading** field displays the value of the ADC output coming out of the sensor in accordance with the mode that is engaged.
- Click **Stop Data Acquisition** to stop data sampling.
- Click **Exit** to close the entire program.
- In the **Scale Max** text box, enter a maximum value for the scale (vertical axis), and click **Manual Re-Scale** to re-set.
- Click **Automatic Re-Scale** to re-scale the vertical axis to an appropriate field of view. This feature is useful if the sampled data is out of the range of the graph or if you need to zoom in on the data.

Saving Measurements to File

Use the **Save Measurements to File** dialog box in the lower right corner of the **ISL76683 Light Sensor Evaluation Software** window to save a series of measurements to disk. Click **Browse** to enter a filename and select a file path. Click **Write to Disk** to write the current graph data to disk.

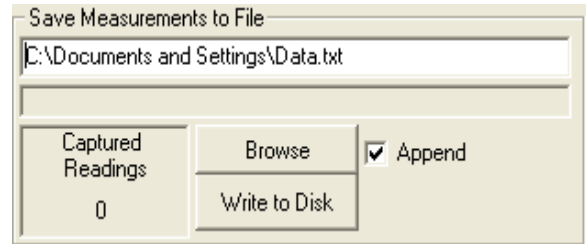

FIGURE 14. SAVE MEASUREMENTS TO FILE

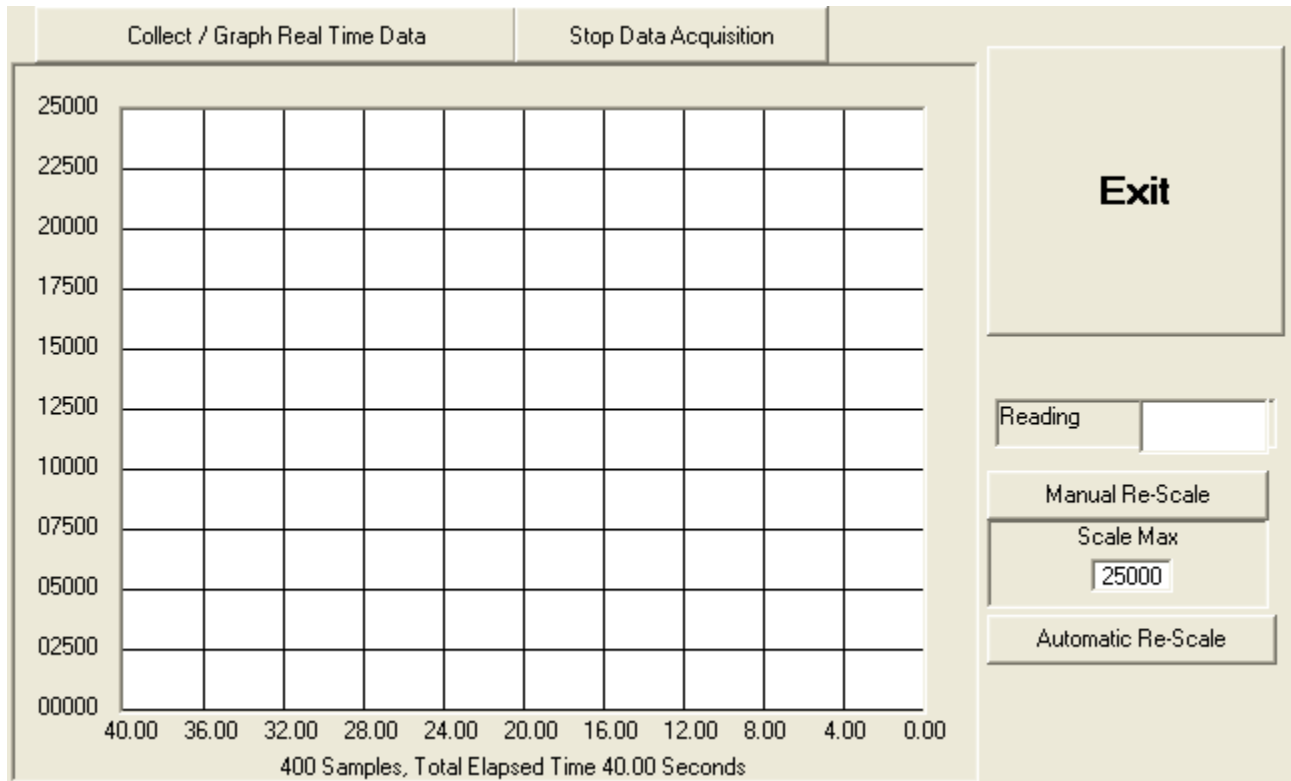

FIGURE 13. GRAPHICAL REAL-TIME DATA COLLECTION

Notice

1. Descriptions of circuits, software and other related information in this document are provided only to illustrate the operation of semiconductor products and application examples. You are fully responsible for the incorporation or any other use of the circuits, software, and information in the design of your product or system. Renesas Electronics disclaims any and all liability for any losses and damages incurred by you or third parties arising from the use of these circuits, software, or information.
2. Renesas Electronics hereby expressly disclaims any warranties against and liability for infringement or any other claims involving patents, copyrights, or other intellectual property rights of third parties, by or arising from the use of Renesas Electronics products or technical information described in this document, including but not limited to, the product data, drawings, charts, programs, algorithms, and application examples.
3. No license, express, implied or otherwise, is granted hereby under any patents, copyrights or other intellectual property rights of Renesas Electronics or others.
4. You shall not alter, modify, copy, or reverse engineer any Renesas Electronics product, whether in whole or in part. Renesas Electronics disclaims any and all liability for any losses or damages incurred by you or third parties arising from such alteration, modification, copying or reverse engineering.
5. Renesas Electronics products are classified according to the following two quality grades: "Standard" and "High Quality". The intended applications for each Renesas Electronics product depends on the product's quality grade, as indicated below.
"Standard": Computers; office equipment; communications equipment; test and measurement equipment; audio and visual equipment; home electronic appliances; machine tools; personal electronic equipment; industrial robots; etc.
"High Quality": Transportation equipment (automobiles, trains, ships, etc.); traffic control (traffic lights); large-scale communication equipment; key financial terminal systems; safety control equipment; etc.
Unless expressly designated as a high reliability product or a product for harsh environments in a Renesas Electronics data sheet or other Renesas Electronics document, Renesas Electronics products are not intended or authorized for use in products or systems that may pose a direct threat to human life or bodily injury (artificial life support devices or systems; surgical implantations; etc.), or may cause serious property damage (space system; undersea repeaters; nuclear power control systems; aircraft control systems; key plant systems; military equipment; etc.). Renesas Electronics disclaims any and all liability for any damages or losses incurred by you or any third parties arising from the use of any Renesas Electronics product that is inconsistent with any Renesas Electronics data sheet, user's manual or other Renesas Electronics document.
6. When using Renesas Electronics products, refer to the latest product information (data sheets, user's manuals, application notes, "General Notes for Handling and Using Semiconductor Devices" in the reliability handbook, etc.), and ensure that usage conditions are within the ranges specified by Renesas Electronics with respect to maximum ratings, operating power supply voltage range, heat dissipation characteristics, installation, etc. Renesas Electronics disclaims any and all liability for any malfunctions, failure or accident arising out of the use of Renesas Electronics products outside of such specified ranges.
7. Although Renesas Electronics endeavors to improve the quality and reliability of Renesas Electronics products, semiconductor products have specific characteristics, such as the occurrence of failure at a certain rate and malfunctions under certain use conditions. Unless designated as a high reliability product or a product for harsh environments in a Renesas Electronics data sheet or other Renesas Electronics document, Renesas Electronics products are not subject to radiation resistance design. You are responsible for implementing safety measures to guard against the possibility of bodily injury, injury or damage caused by fire, and/or danger to the public in the event of a failure or malfunction of Renesas Electronics products, such as safety design for hardware and software, including but not limited to redundancy, fire control and malfunction prevention, appropriate treatment for aging degradation or any other appropriate measures. Because the evaluation of microcomputer software alone is very difficult and impractical, you are responsible for evaluating the safety of the final products or systems manufactured by you.
8. Please contact a Renesas Electronics sales office for details as to environmental matters such as the environmental compatibility of each Renesas Electronics product. You are responsible for carefully and sufficiently investigating applicable laws and regulations that regulate the inclusion or use of controlled substances, including without limitation, the EU RoHS Directive, and using Renesas Electronics products in compliance with all these applicable laws and regulations. Renesas Electronics disclaims any and all liability for damages or losses occurring as a result of your noncompliance with applicable laws and regulations.
9. Renesas Electronics products and technologies shall not be used for or incorporated into any products or systems whose manufacture, use, or sale is prohibited under any applicable domestic or foreign laws or regulations. You shall comply with any applicable export control laws and regulations promulgated and administered by the governments of any countries asserting jurisdiction over the parties or transactions.
10. It is the responsibility of the buyer or distributor of Renesas Electronics products, or any other party who distributes, disposes of, or otherwise sells or transfers the product to a third party, to notify such third party in advance of the contents and conditions set forth in this document.
11. This document shall not be reprinted, reproduced or duplicated in any form, in whole or in part, without prior written consent of Renesas Electronics.
12. Please contact a Renesas Electronics sales office if you have any questions regarding the information contained in this document or Renesas Electronics products.
(Note 1) "Renesas Electronics" as used in this document means Renesas Electronics Corporation and also includes its directly or indirectly controlled subsidiaries.
(Note 2) "Renesas Electronics product(s)" means any product developed or manufactured by or for Renesas Electronics.

(Rev.4.0-1 November 2017)



SALES OFFICES

Renesas Electronics Corporation

<http://www.renesas.com>

Refer to "<http://www.renesas.com/>" for the latest and detailed information.

Renesas Electronics America Inc.
1001 Murphy Ranch Road, Milpitas, CA 95035, U.S.A.
Tel: +1-408-432-8888, Fax: +1-408-434-5351

Renesas Electronics Canada Limited
9251 Yonge Street, Suite 8309 Richmond Hill, Ontario Canada L4C 9T3
Tel: +1-905-237-2004

Renesas Electronics Europe Limited
Dukes Meadow, Millboard Road, Bourne End, Buckinghamshire, SL8 5FH, U.K
Tel: +44-1628-651-700, Fax: +44-1628-651-804

Renesas Electronics Europe GmbH
Arcadiastrasse 10, 40472 Düsseldorf, Germany
Tel: +49-211-6503-0, Fax: +49-211-6503-1327

Renesas Electronics (China) Co., Ltd.
Room 1709 Quantum Plaza, No.27 ZhichunLu, Haidian District, Beijing, 100191 P. R. China
Tel: +86-10-8235-1155, Fax: +86-10-8235-7679

Renesas Electronics (Shanghai) Co., Ltd.
Unit 301, Tower A, Central Towers, 555 Langao Road, Putuo District, Shanghai, 200333 P. R. China
Tel: +86-21-2226-0888, Fax: +86-21-2226-0999

Renesas Electronics Hong Kong Limited
Unit 1601-1611, 16/F., Tower 2, Grand Century Place, 193 Prince Edward Road West, Mongkok, Kowloon, Hong Kong
Tel: +852-2265-6688, Fax: +852-2886-9022

Renesas Electronics Taiwan Co., Ltd.
13F, No. 363, Fu Shing North Road, Taipei 10543, Taiwan
Tel: +886-2-8175-9600, Fax: +886-2-8175-9670

Renesas Electronics Singapore Pte. Ltd.
80 Bendemeer Road, Unit #06-02 Hyflux Innovation Centre, Singapore 339949
Tel: +65-6213-0200, Fax: +65-6213-0300

Renesas Electronics Malaysia Sdn.Bhd.
Unit 1207, Block B, Menara Amcorp, Amcorp Trade Centre, No. 18, Jln Persiaran Barat, 46050 Petaling Jaya, Selangor Darul Ehsan, Malaysia
Tel: +60-3-7955-9390, Fax: +60-3-7955-9510

Renesas Electronics India Pvt. Ltd.
No.777C, 100 Feet Road, HAL 2nd Stage, Indiranagar, Bangalore 560 038, India
Tel: +91-80-67208700, Fax: +91-80-67208777

Renesas Electronics Korea Co., Ltd.
17F, KAMCO Yangjae Tower, 262, Gangnam-daero, Gangnam-gu, Seoul, 06265 Korea
Tel: +82-2-558-3737, Fax: +82-2-558-5338