

ISL78225EVAL1Z: 4-Phase Interleaved Synchronous Boost Converter

ISL78225EVAL1Z Evaluation Board

The ISL78225EVAL1Z evaluation board features the ISL78225 4-phase interleaved boost controller and four ISL78420 100V MOSFET drivers. The ISL78225 and ISL78420s are configured as a 4-phase synchronous boost converter for 10V to 16V input into 36V output at 10A. The interleaved timing reduces input and output ripple current, thereby reducing the required number of input and output capacitors.

The ISL78225 enhances light load efficiency by dropping phases with decreasing load, by emulating a diode while stopping reverse current in the synchronous output switch, and by skipping switch pulses at very light loads. The ISL78420 facilitates diode emulation by translating the midrange of the tri-level PWM out from the ISL78225 to turn both output switches off.

For a 6-phase interleaved boost controller, please see the [ISL78220](#).

Recommended Equipment

- 0V to 20V main power supply with at least 40A source current capability
- 10V bias power supply with at least 100mA source current capability
- 40V electronic load capable of sinking up to 10A
- Digital Multimeters (DMMs)
- 100MHz Quad-Trace Oscilloscope

Quick Test Guide

1. Set main power supply to 10V, turn off, and connect to VIN and GND terminals on board.
2. Set electronic load for 1A, turn off, and connect to VOUT and GND terminals on board.
3. Set bias power supply to 10V, turn off, and connect to TP12 (VDR) and TP26 (GND) on board.
4. Turn on the bias power supply.
5. Turn on the main power supply.
6. Turn on the electronic load.
7. Adjust the main power supply in the range of 10V to 16V as desired.
8. Adjust the electronic load in the range of 0A to 10A as desired.
9. Turn off the main power supply.
10. Turn off the bias power supply.
11. Turn off the electronic load.

The default is phase dropping mode. For continuous switching mode, move shunt from JP14 to JP16 while the main power is turned off.

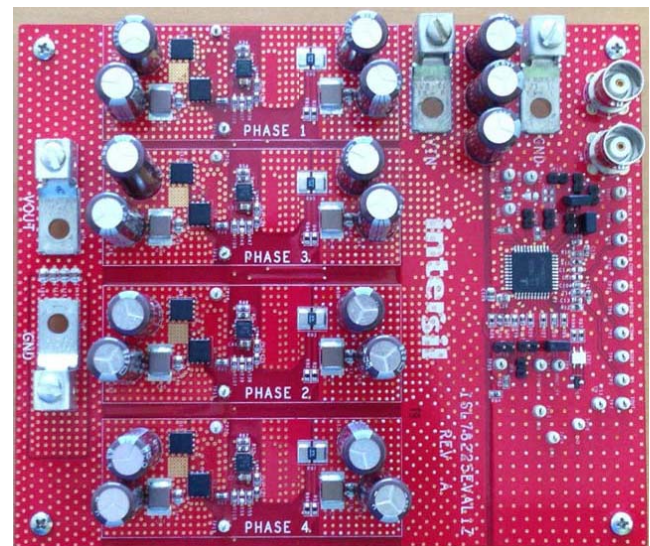

FIGURE 1. PHOTO OF ISL78225EVAL1Z EVALUATION BOARD

Application Note 1727

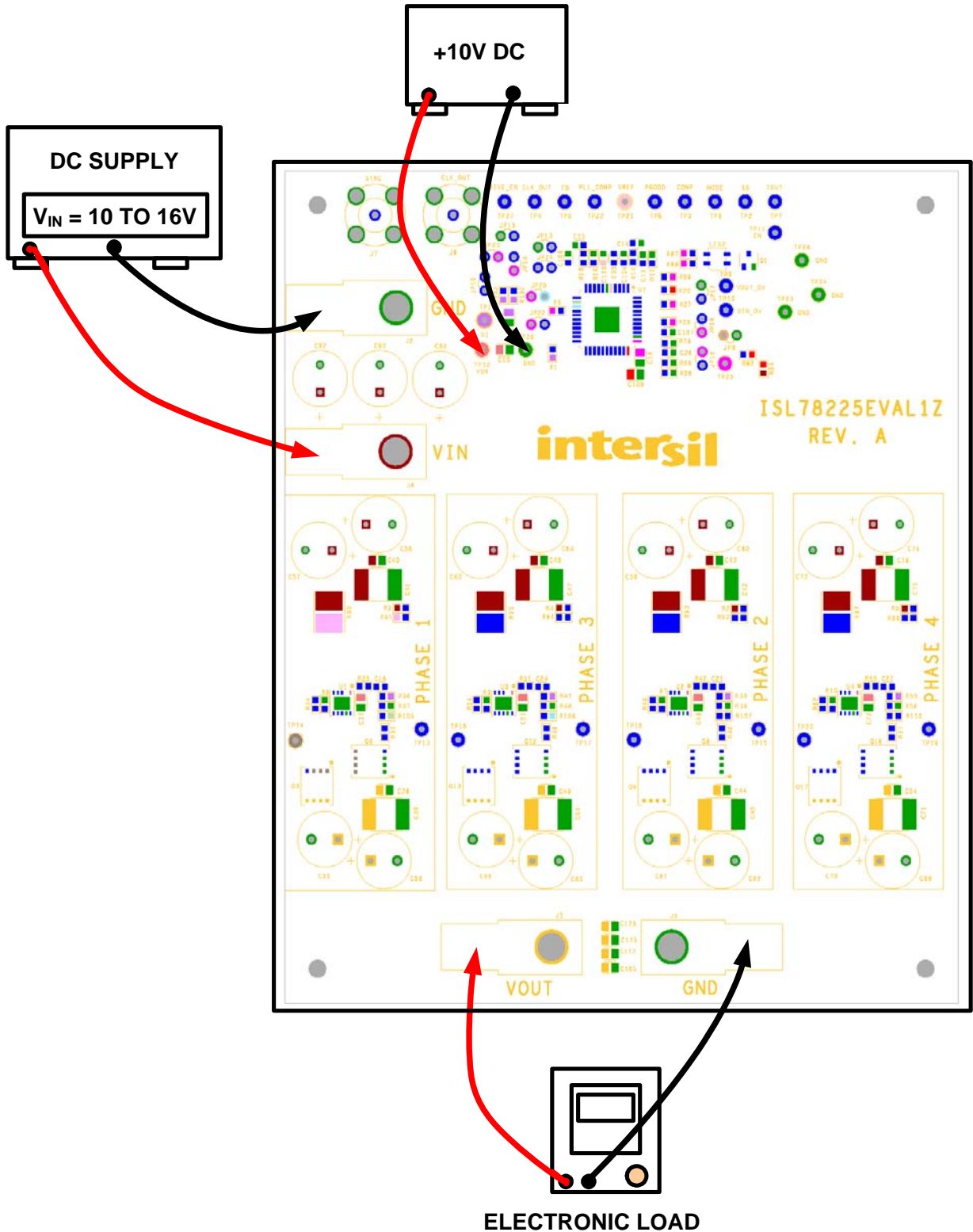

FIGURE 2. ISL78225EVAL1Z CONNECTIONS

NOTE: In layout point of view, TP12/TP26 positions are not good to add the driving bias voltage. The input nodes for the driving bias should be placed close to drivers and away from the sensitive lines like current sense signals. The board will be updated later.

Typical Performance Curves

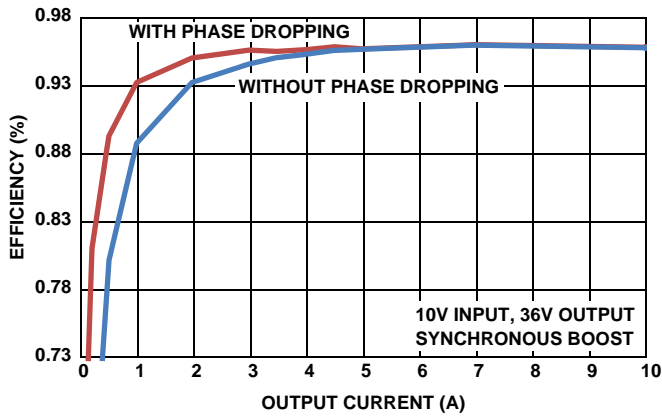

FIGURE 3. 10V INPUT EFFICIENCY vs OUTPUT CURRENT vs PHASE DROPPING MODE

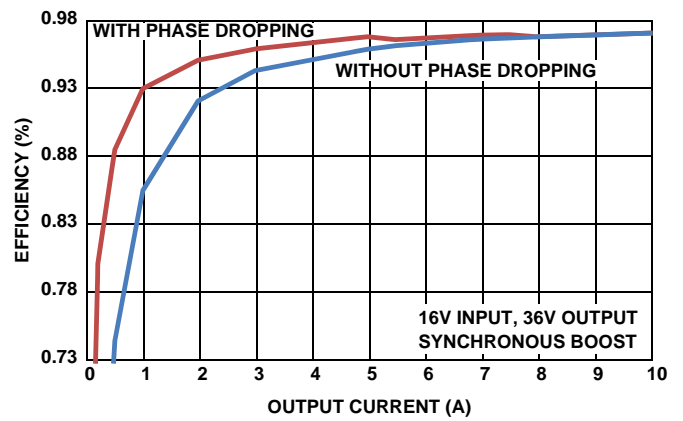

FIGURE 4. 16V INPUT EFFICIENCY vs OUTPUT CURRENT vs PHASE DROPPING MODE

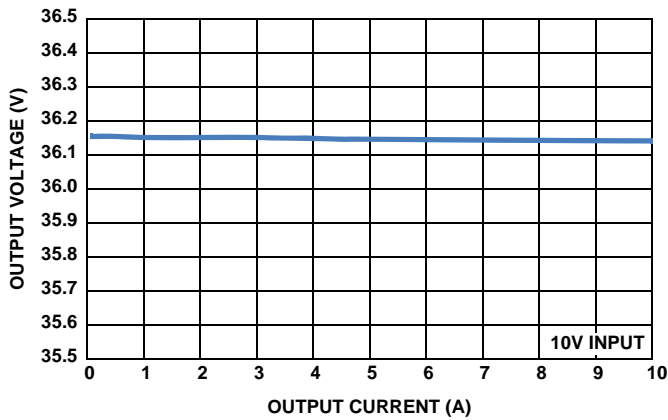

FIGURE 5. OUTPUT VOLTAGE vs OUTPUT CURRENT

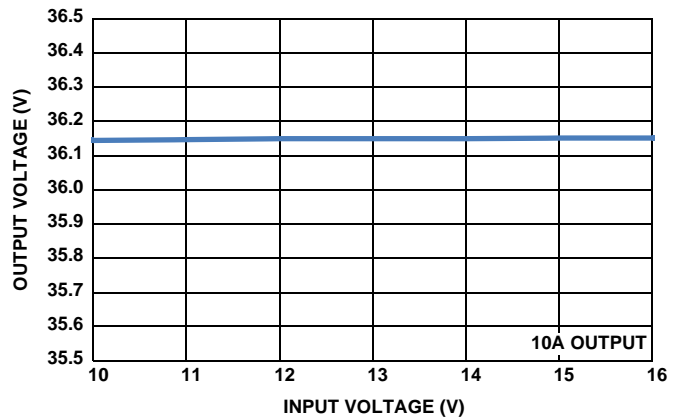

FIGURE 6. OUTPUT VOLTAGE vs INPUT VOLTAGE

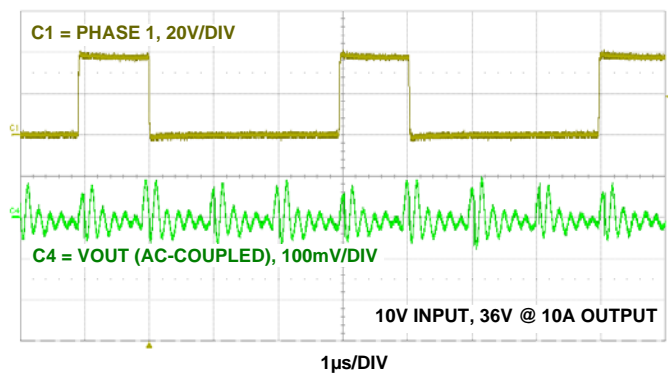

FIGURE 7. FULL LOAD OUTPUT RIPPLE

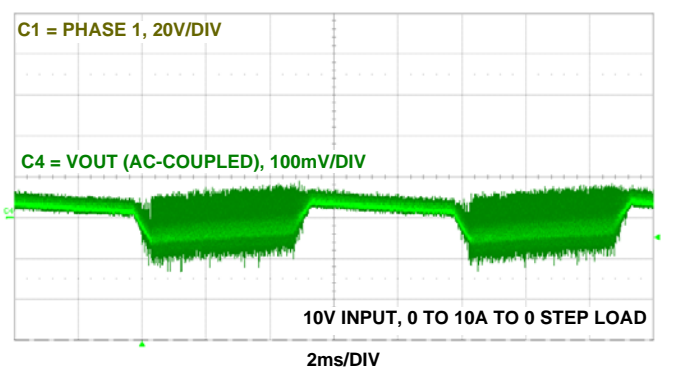

FIGURE 8. FULL STEP LOAD TRANSIENT

Schematics

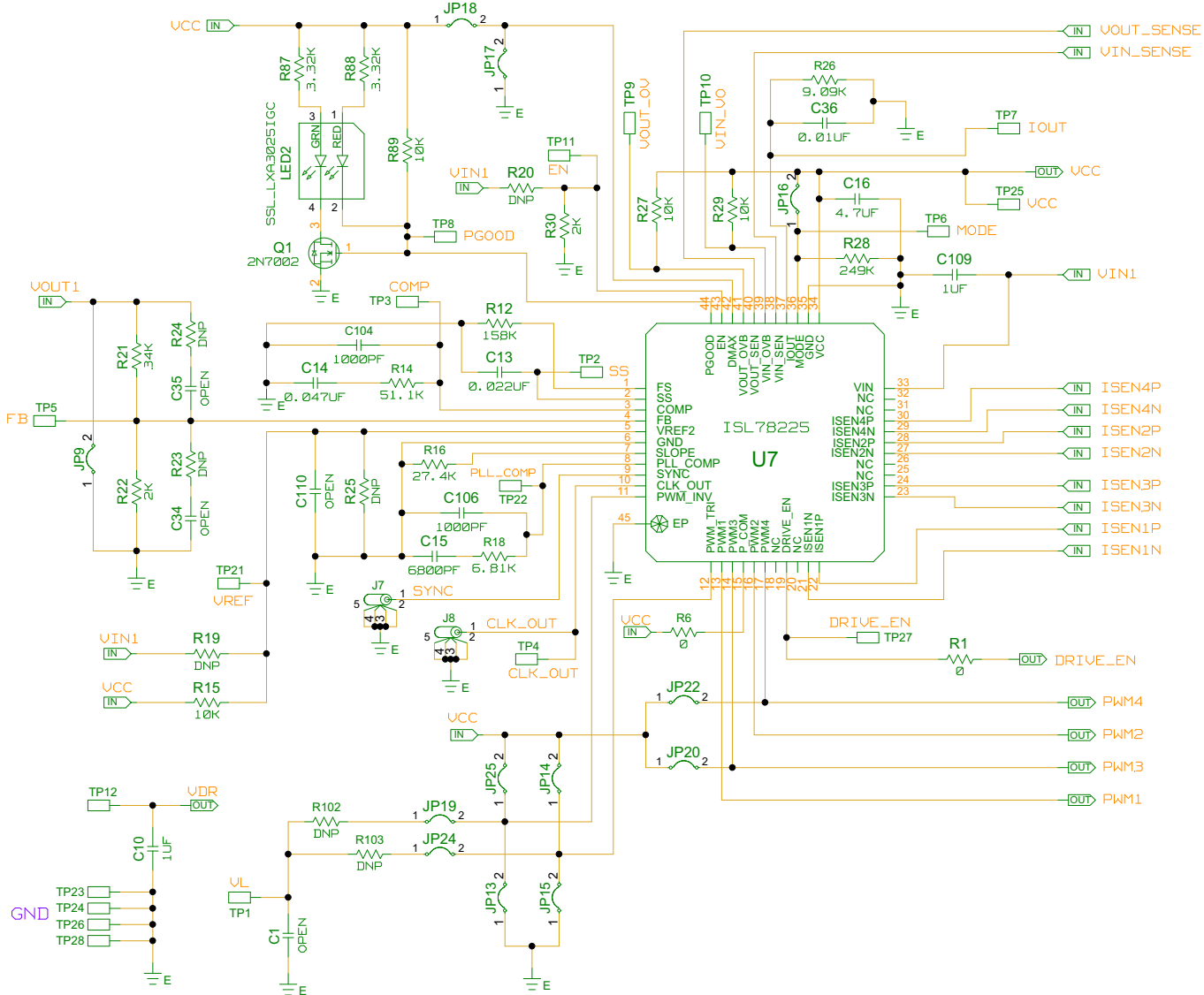

FIGURE 9. ISL78225EVAL12 SCHEMATIC PAGE 1

Schematics (Continued)

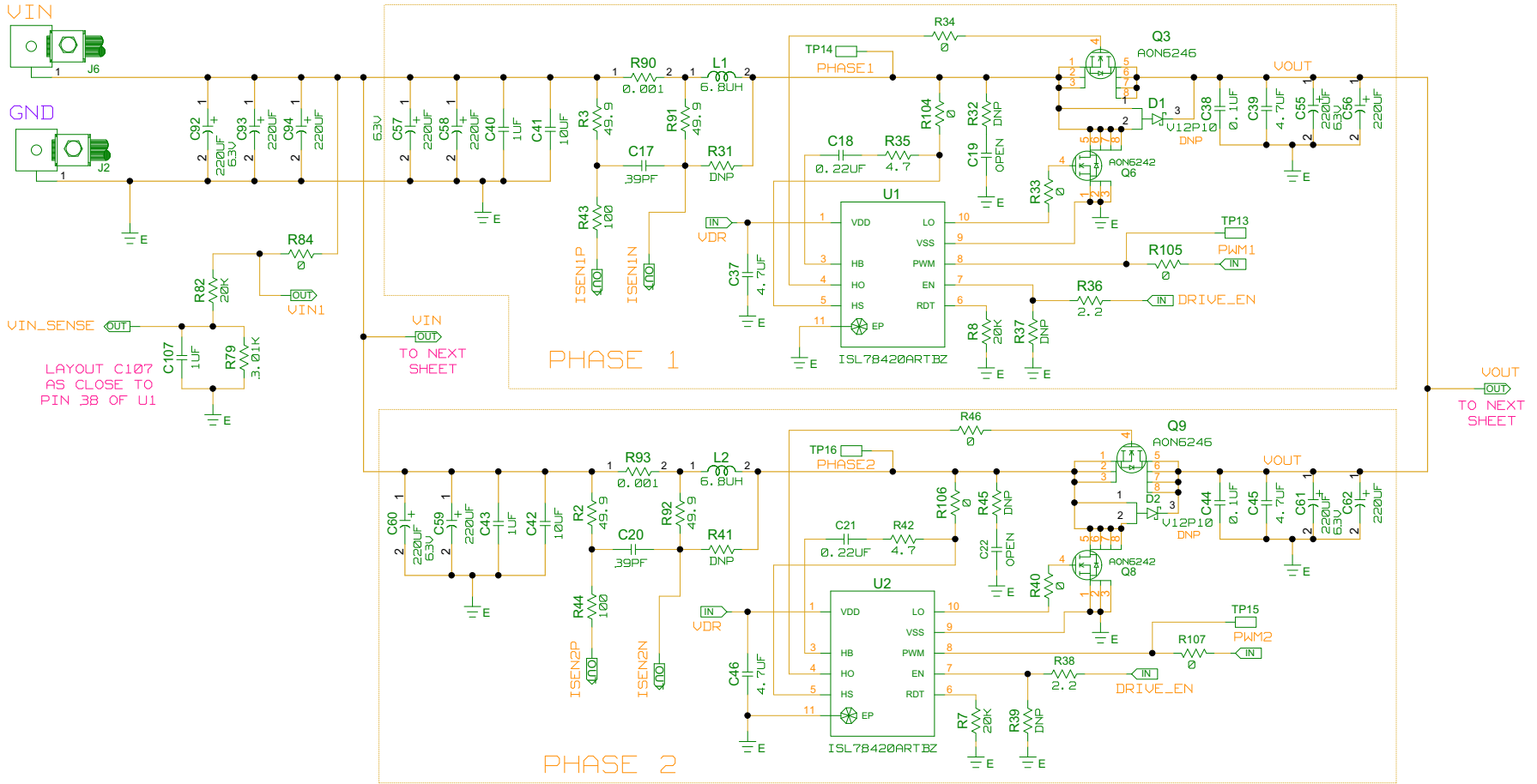

FIGURE 10. ISL78225EVAL1Z SCHEMATIC PAGE 2

Schematics (Continued)

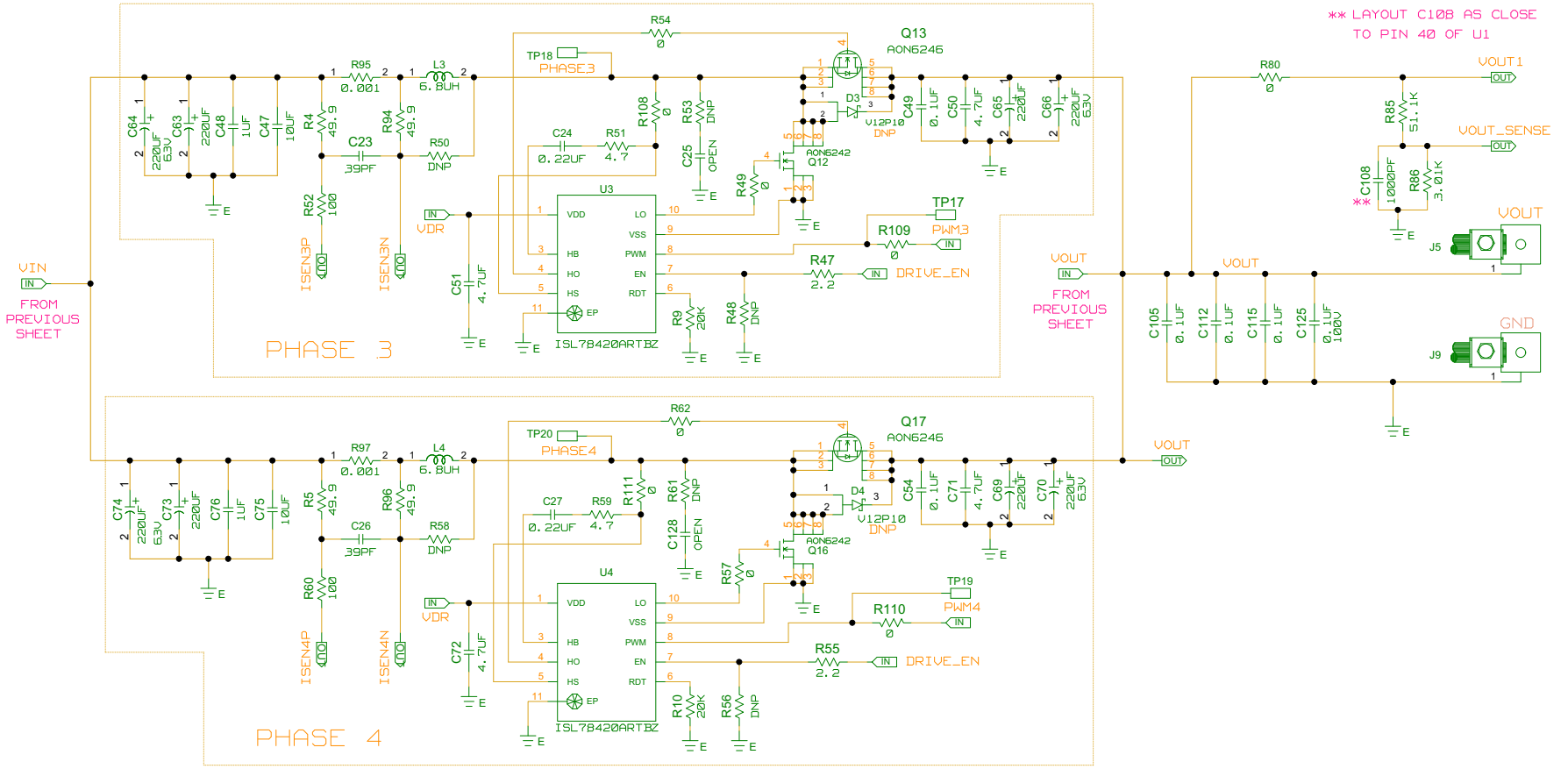

FIGURE 11. ISL78225EVAL1Z SCHEMATIC PAGE 3

Application Note 1727

TABLE 1. BILL OF MATERIALS

ITEM	QTY	PART REFERENCE	PART NUMBER	DESCRIPTION	MANUFACTURER
1	1	C107	C1608X7R1C105K	CAP, SMD, 0603, 1.0µF, 16V, 10%, X7R, ROHS	TDK
2	4	C37, C46, C51, C72	C2012X7R1E475K125AB	CAP, SMD, 0805, 4.7µF, 25V, 10%, X7R, ROHS	TDK
3	4	C41, C42, C47, C75	C5750X7R1H106K	CAP, SMD, 2220, 10µF, 50V, 10%, X7R, ROHS	TDK
4	4	C39, C45, C50, C71	C5750X7R2A475K	CAP, SMD, 2220, 4.7µF, 100V, 10%, X7R, ROHS	TDK
5	1	C16	GRM21BR71C475KA73L	CAP, SMD, 0805, 4.7µF, 16V, 10%, X7R, ROHS	MURATA
6	6	C10, C40, C43, C48, C76, C109	GRM21BR71H105KA12L	CAP, SMD, 0805, 1.0µF, 50V, 10%, X7R, ROHS	MURATA
7	3	C104, C106, C108	06035C102KAT2A	CAP, SMD, 0603, 1000pF, 50V, 10%, X7R, ROHS	AVX
8	1	C36	C0603X7R160-103KNE	CAP, SMD, 0603, 0.01µF, 16V, 10%, X7R, ROHS	VENKEL
9	1	C13	C0603X7R500-223KNE	CAP, SMD, 0603, 0.022µF, 50V, 10%, X7R, ROHS	VENKEL
10	4	C18, C21, C24, C27	GCM188R71H224KA64D	CAP, SMD, 0603, 0.22µF, 50V, 10%, X7R, ROHS	MURATA
11	4	C17, C20, C23, C26	ECJ-1VC1H330J	CAP, SMD, 0603, 39pF, 50V, 5%, NP0, ROHS	PANASONIC
12	1	C14	GRM188R71E473KA01D	CAP, SMD, 0603, 0.047µF, 25V, 10%, X7R, ROHS	MURATA
13	1	C15	06035C682KAT9A	CAP, SMD, 0603, 6800PF, 50V, 10%, X7R, ROHS	AVX
14	0	C19, C22, C25, C34, C35, C110, C128		CAP, SMD, 0603, DNP-PLACE HOLDER, ROHS	
15	8	C38, C44, C49, C54, C105, C112, C125, C115	C2012X7R2A104K	CAP, SMD, 0805, 0.1µF, 100V, 10%, X7R, ROHS	TDK
16	0	C1		CAP, SMD, 0805, DNP-PLACE HOLDER, ROHS	
17	19	C55-C66, C69, C70, C73, C74, C92-C94.	EKZE630ELL221MJ25S	CAP, RADIAL, 10x25, 220µF, 63V, 20%, ALUM.ELEC., 5mm, ROHS	UNITED CHEMI-CON
18	4	L1-L4	IHLP6767GZER6R8M11	COIL-PWR INDUCTOR, SMD, 17.15mm, 6.8µH, 20%, 22.5A, ROHS	VISHAY
19	2	J7, J8	31-5329-52RFX	CONN-BNC, RECEPTACLE, TH, 4 POST, 50Ω, GOLDCONTACT, ROHS	AMPHENOL
20	28	TP1-TP28	5002	CONN-MINI TEST POINT, VERTICAL, WHITE, ROHS	KEYSTONE
21	12	JP9, JP13-JP20, JP22, JP24, JP25	69190-202HLF	CONN-HEADER, 1x2, RETENTIVE, 2.54mm, 0.230x 0.120, ROHS	BERG/FCI
22	3	JP13, JP14, JP17	SPC02SYAN	CONN-JUMPER, SHORTING, 2PIN, BLACK, GOLD, ROHS	SULLINS
23	1	LED2	SSL-LXA3025IGC-TR	LED, SMD, 3x2.5mm, 4P, RED/GREEN, 12/20MCD, 2V	LUMEX
24	1	U7	ISL78225ANEZ	IC-4 PHASE PWM CONTROLLER, 44P, EP-TQFP, 10X10, ROHS	INTERSIL
25	4	U1-U4	ISL78420ARTBZ	IC-2A, 100V, HALF-BRIDGE DRIVER, 9P, TDFN, 4x4, ROHS	INTERSIL
26	1	Q1	2N7002LT1G	TRANSISTOR-MOS, N-CHANNEL, SMD, SOT23, 60V, 115mA, ROHS	ON SEMICONDUCTOR
27	4	Q6, Q8, Q12, Q16	AON6242	TRANSISTOR-MOS, N-CHANNEL, 60V, 85A, 8P, DFN, 5X6, ROHS	ALPHA & OMEGA SEMICONDUCTOR
28	4	Q3, Q9, Q13, Q17	AON6246	TRANSISTOR-MOS, N-CHANNEL, 60V, 80A, 8P, DFN, 5x6, ROHS	ALPHA & OMEGA SEMICONDUCTOR
29	4	R36, R38, R47, R55	ERJ-3RQF2R2V	RES, SMD, 0603, 2.2Ω, 1/10W, 1%, TF, ROHS	PANASONIC
30	4	R35, R42, R51, R59	CR0603-10W-4R70FT	RES, SMD, 0603, 4.7Ω, 1/10W, 1%, TF, ROHS	VENKEL

Application Note 1727

TABLE 1. BILL OF MATERIALS

ITEM	QTY	PART REFERENCE	PART NUMBER	DESCRIPTION	MANUFACTURER
31	20	R1, R6, R33, R34, R40, R46, R49, R54, R57, 62, R80, R84, R104-R111.	CR0603-10W-000T	RES, SMD, 0603, 0Ω, 1/10W, TF, ROHS	VENKEL
32	4	R43, R44, R52, R60	CR0603-10W-1000FT	RES, SMD, 0603, 100Ω, 1/10W, 1%, TF, ROHS	VENKEL
33	4	R15, R27, R29, R89	RK73H1JT1002F	RES, SMD, 0603, 10K, 1/10W, 1%, TF, ROHS	KOA
34	1	R12	CR0603-10W-1583FT	RES, SMD, 0603, 158K, 1/10W, 1%, TF, ROHS	VENKEL
35	1	R22	RK73H1JT2001F	RES, SMD, 0603, 2K, 1/10W, 1%, TF, ROHS	KOA
36	6	R7, R8, R9, R10, R20, R82	CR0603-10W-2002FT	RES, SMD, 0603, 20K, 1/10W, 1%, TF, ROHS	VENKEL
37	1	R28	9C06031A2493FKHFT	RES, SMD, 0603, 249K, 1/10W, 1%, TF, ROHS	YAGEO
38	1	R16	ERJ-3EKF2742V	RES, SMD, 0603, 27.4K, 1/10W, 1%, TF, ROHS	PANASONIC
39	2	R79, R86	MCR03EZPFX3011	RES, SMD, 0603, 3.01K, 1/10W, 1%, TF, ROHS	ROHM
40	2	R87, R88	RC0603FR-073K32L	RES, SMD, 0603, 3.32K, 1/10W, 1%, TF, ROHS	YAGEO
41	1	R21	CR0603-10W-3402FT	RES, SMD, 0603, 34K, 1/10W, 1%, TF, ROHS	VENKEL
42	1	R30	ERJ-3EKF4991V	RES, SMD, 0603, 4.99K, 1/10W, 1%, TF, ROHS	PANASONIC
43	8	R2-R5, R91, R92, R94, R96.	CR0603-10W-49R9FT	RES, SMD, 0603, 49.9Ω, 1/10W, 1%, TF, ROHS	VENKEL
44	2	R14, R85	CR0603-10W-5112FT	RES, SMD, 0603, 51.1K, 1/10W, 1%, TF, ROHS	VENKEL
45	1	R18	RC0603FR-076K81L	RES, SMD, 0603, 6.81K, 1/10W, 1%, TF, ROHS	YAGEO
46	1	R26	RC0603FR-079K09L	RES, SMD, 0603, 9.09K, 1/10W, 1%, TF, ROHS	YAGEO
47	0	R19, R23-R25, R31, R32, R37, R39, R41, R45, R48, R50, R53, R56, R58, R61, R102, R103.		RES, SMD, 0603, DNP-PLACE HOLDER, ROHS	
48	4	R90, R93, R95, R97	WSL25121L000FEA	RES-CURR. SENSE, SMD, 2512, 0.001Ω, 1W, 1%, ROHS	VISHAY/DALE
49	4	J2, J5, J6, J9	KPA8CTP	HDWARE, MTG, CABLE TERMINAL, 6-14AWG, LUG&SCREW, ROHS	BERG/FCI
50	0	D1-D4 (V12P10-M3/86A)		DO NOT POPULATE OR PURCHASE	

ISL78225EVAL1Z Board Layout

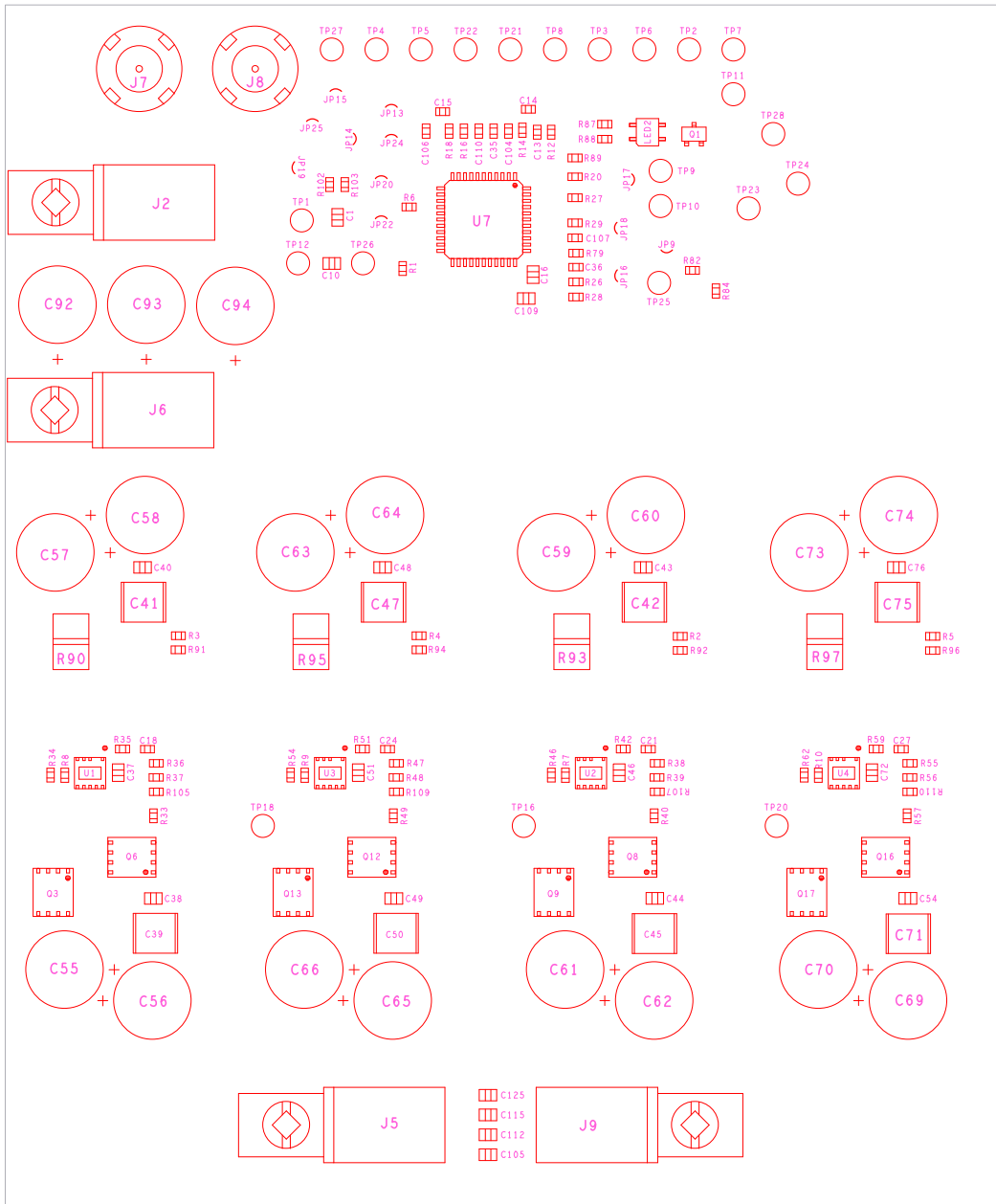

FIGURE 12. ASSEMBLY TOP

ISL78225EVAL1Z Board Layout (Continued)

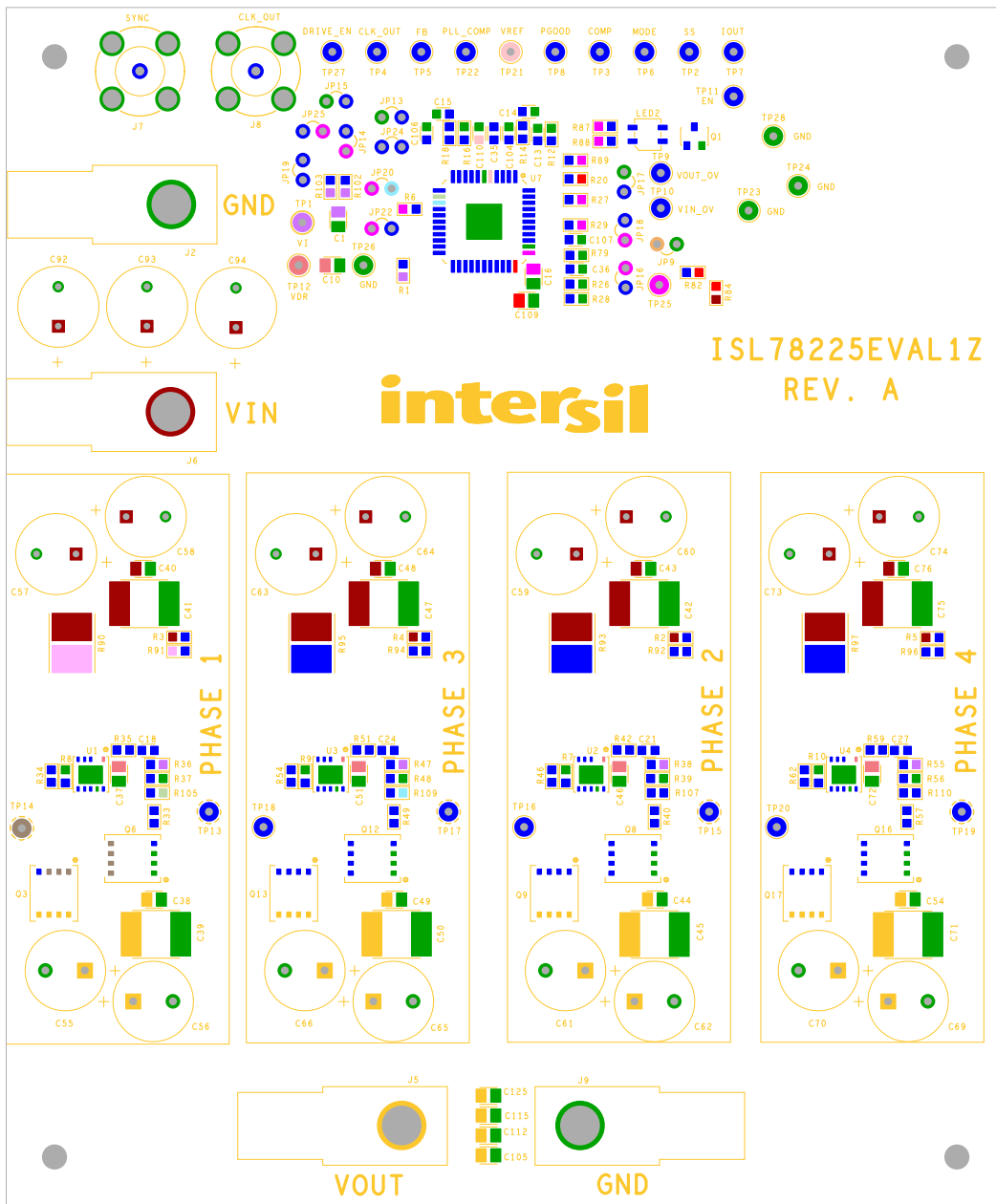

FIGURE 13. SILK SCREEN TOP

ISL78225EVAL1Z Board Layout (Continued)

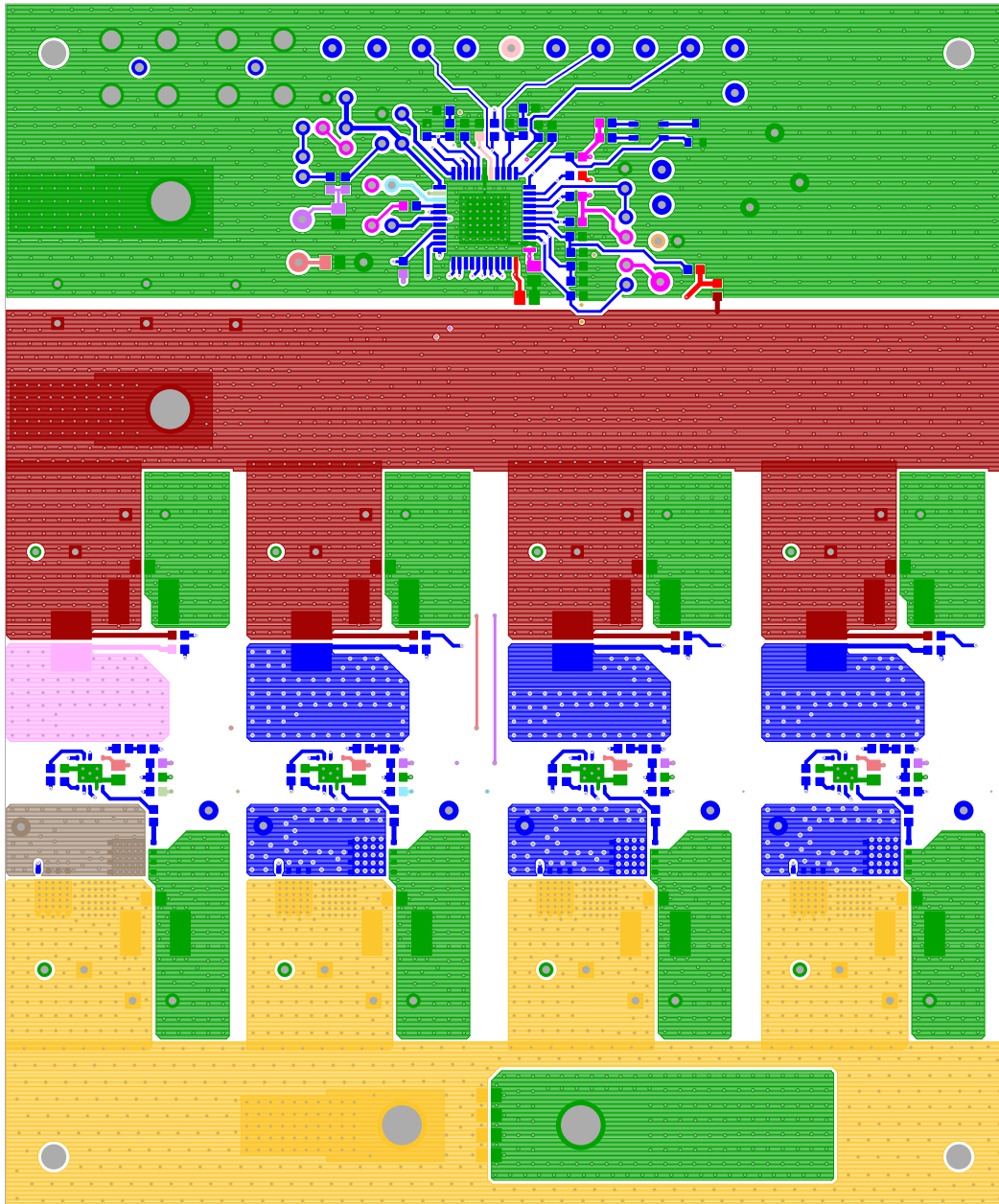

FIGURE 14. TOP LAYER COMPONENT SIDE

ISL78225EVAL1Z Board Layout (Continued)

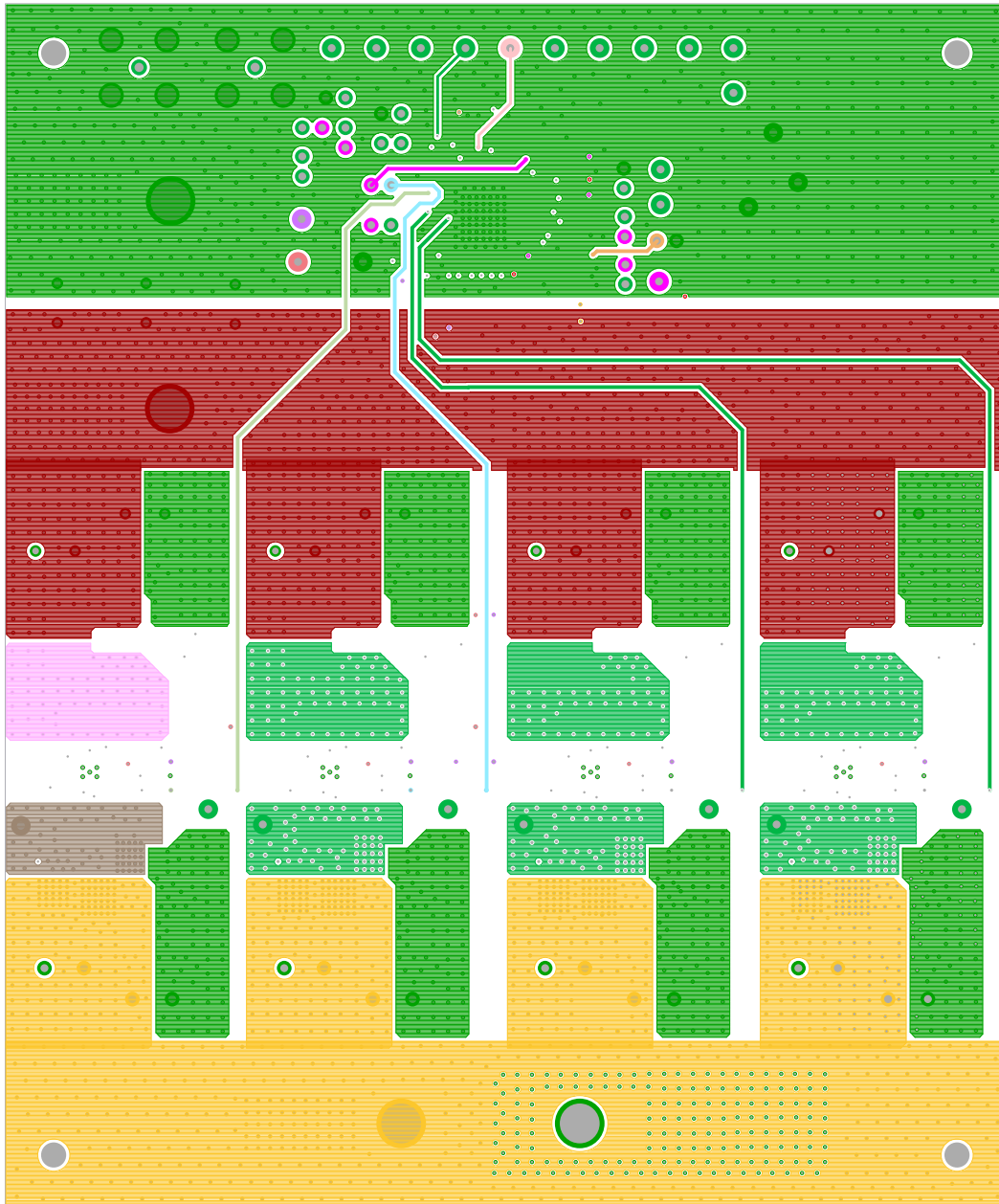

FIGURE 15. LAYER 2

ISL78225EVAL1Z Board Layout (Continued)

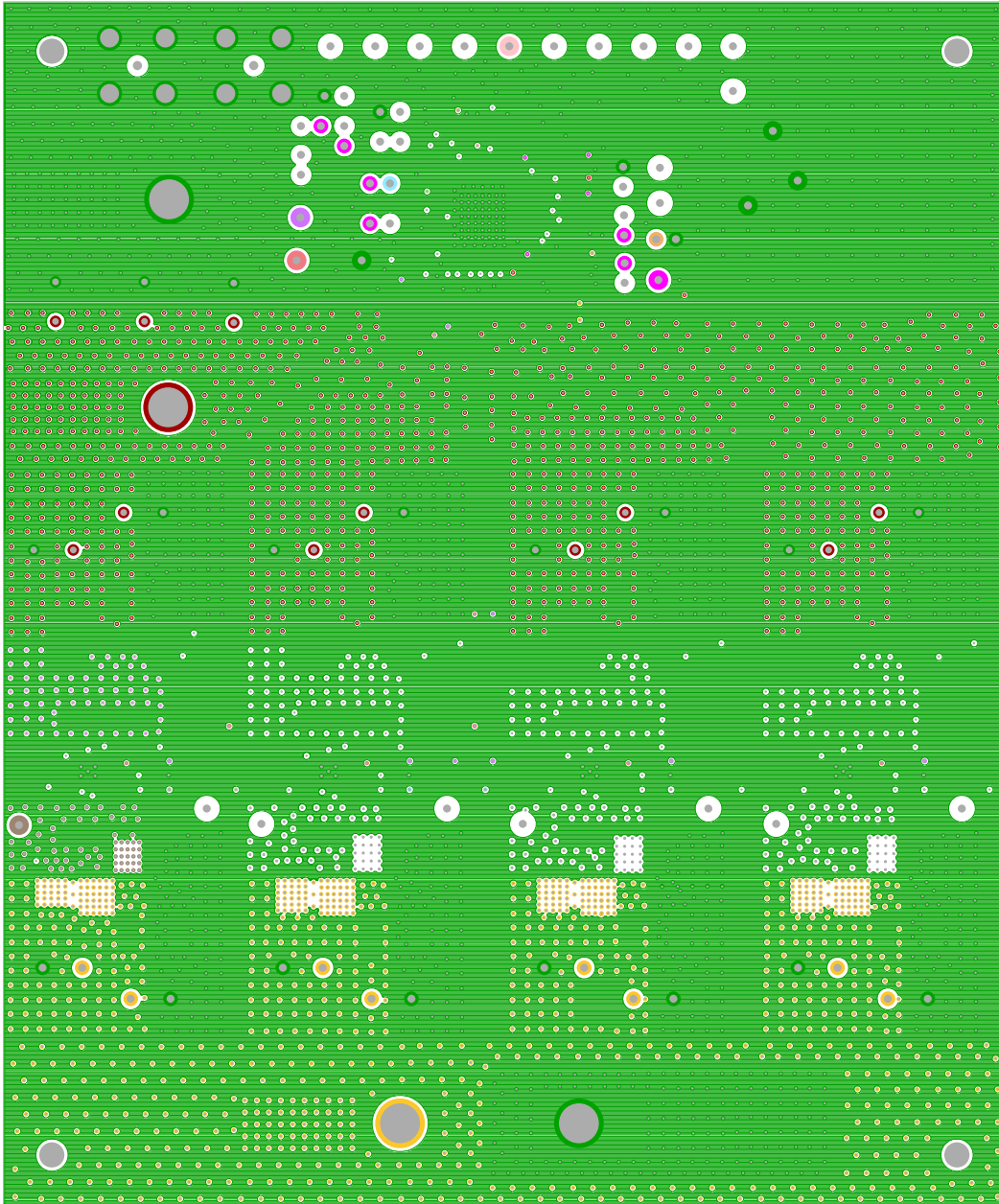

FIGURE 16. LAYER 3

ISL78225EVAL1Z Board Layout (Continued)

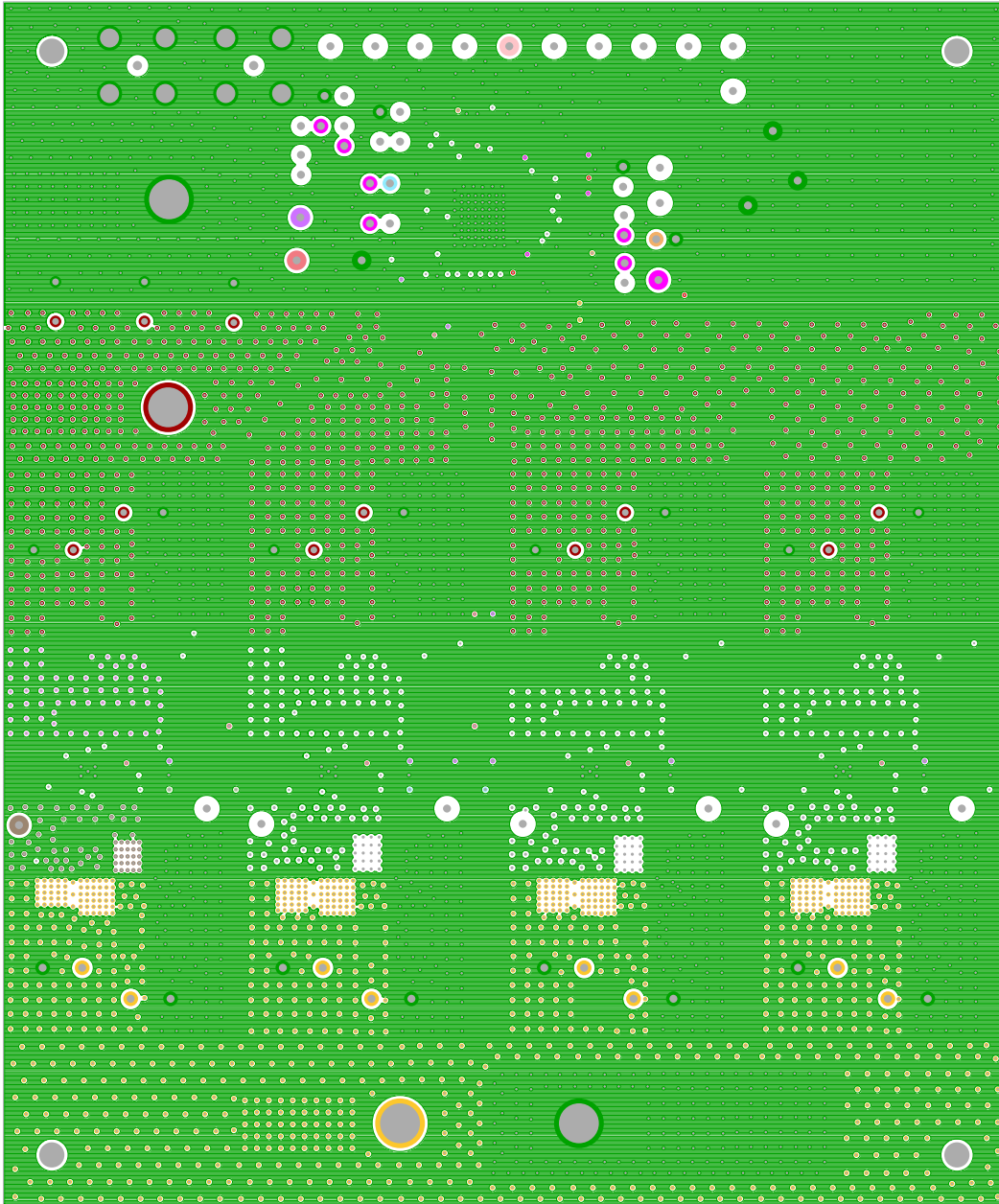

FIGURE 17. LAYER 4

ISL78225EVAL1Z Board Layout (Continued)

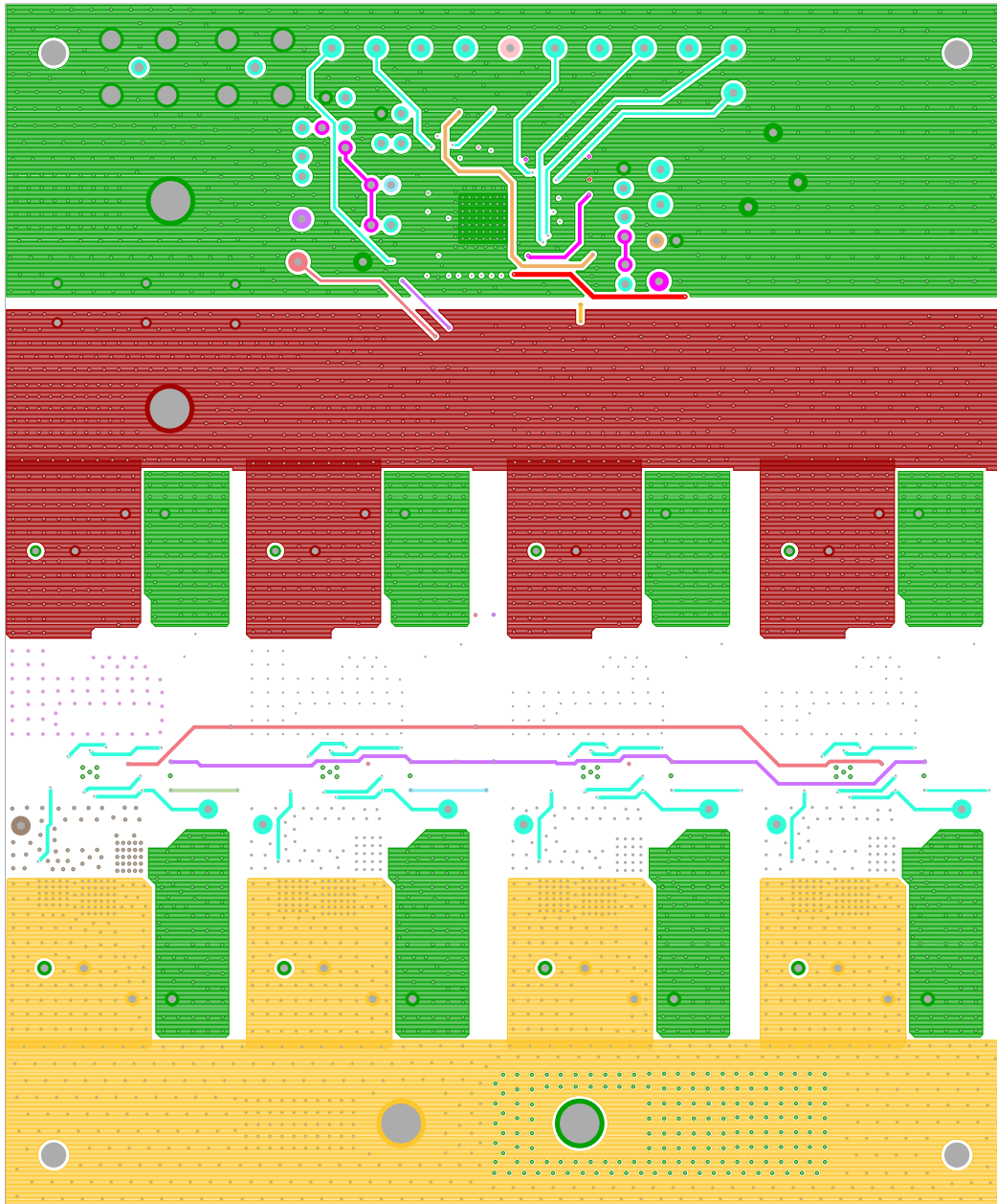

FIGURE 18. LAYER 5

ISL78225EVAL1Z Board Layout (Continued)

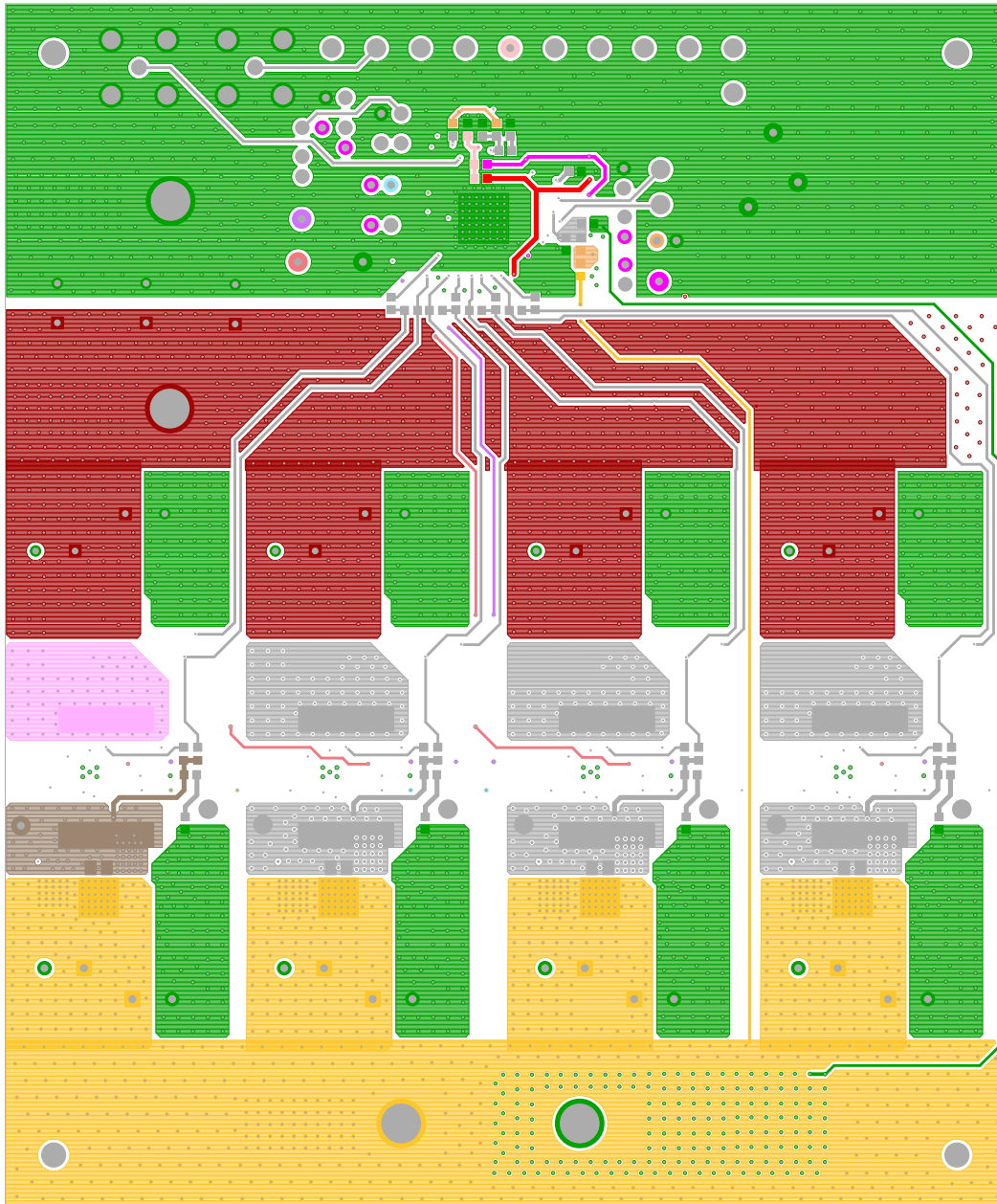

FIGURE 19. BOTTOM LAYER SOLDER SIDE

ISL78225EVAL1Z Board Layout (Continued)

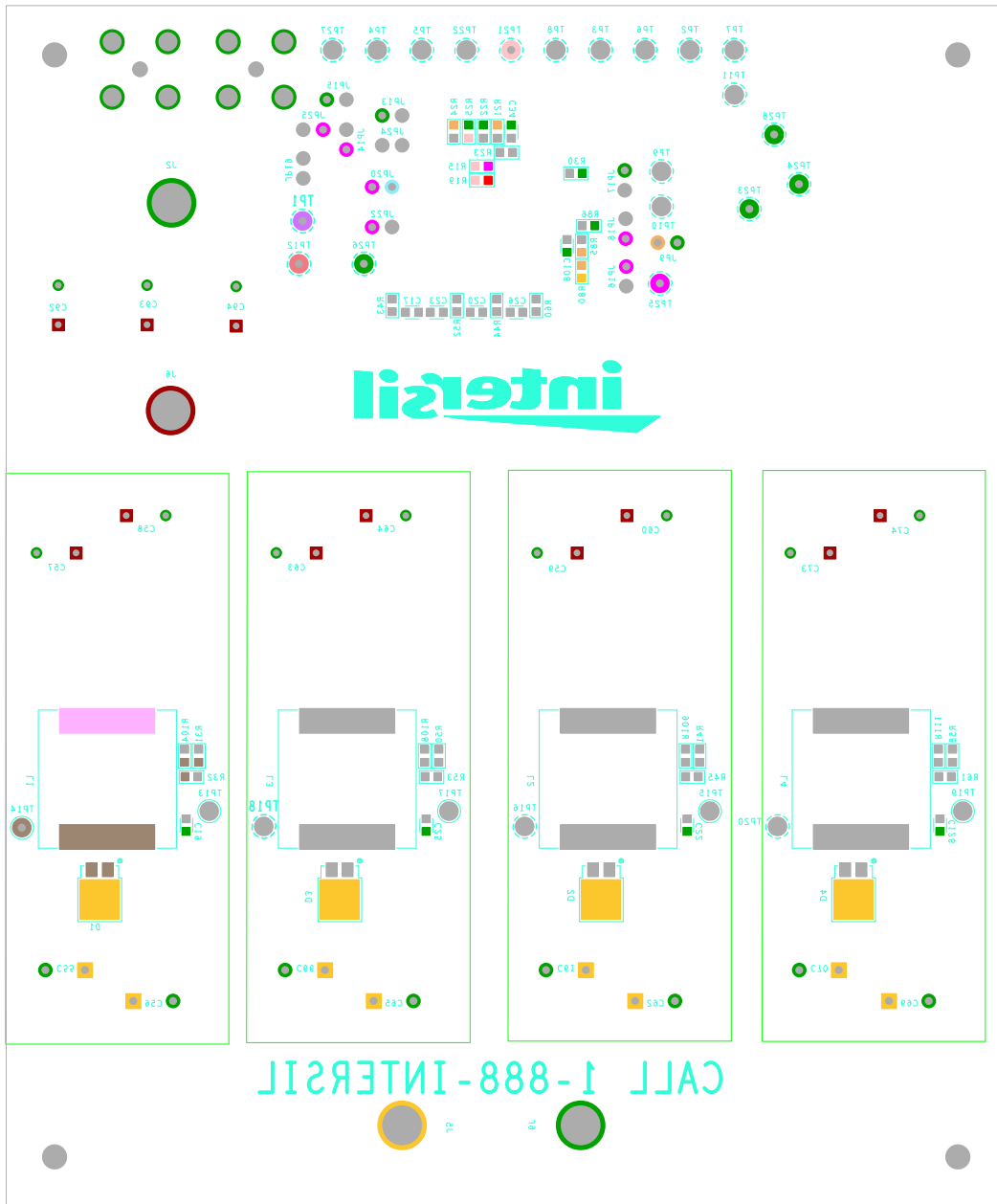

FIGURE 20. SILK SCREEN BOTTOM

ISL78225EVAL1Z Board Layout (Continued)

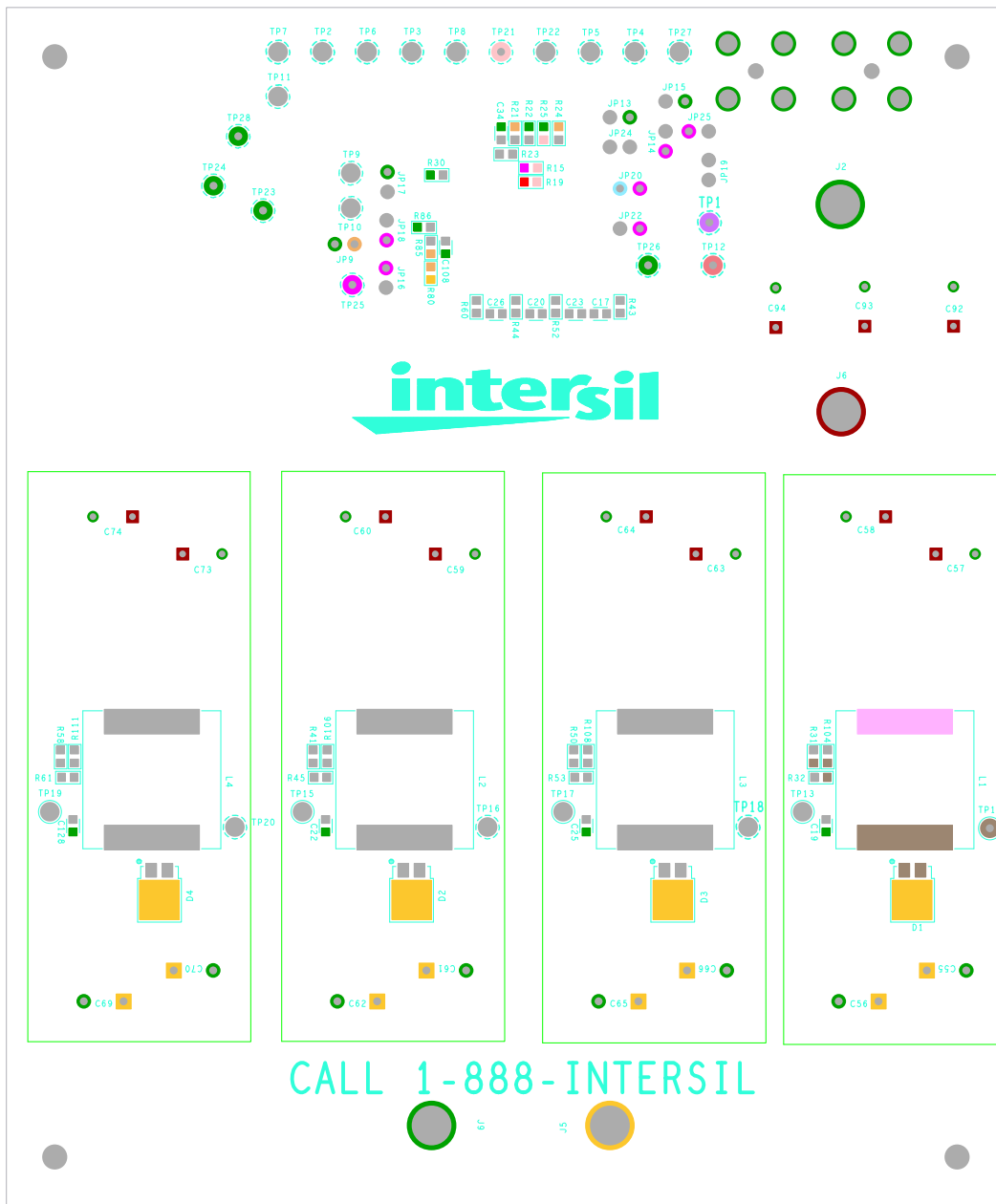

FIGURE 21. SILK SCREEN BOTTOM (MIRRORED)

ISL78225EVAL1Z Board Layout (Continued)

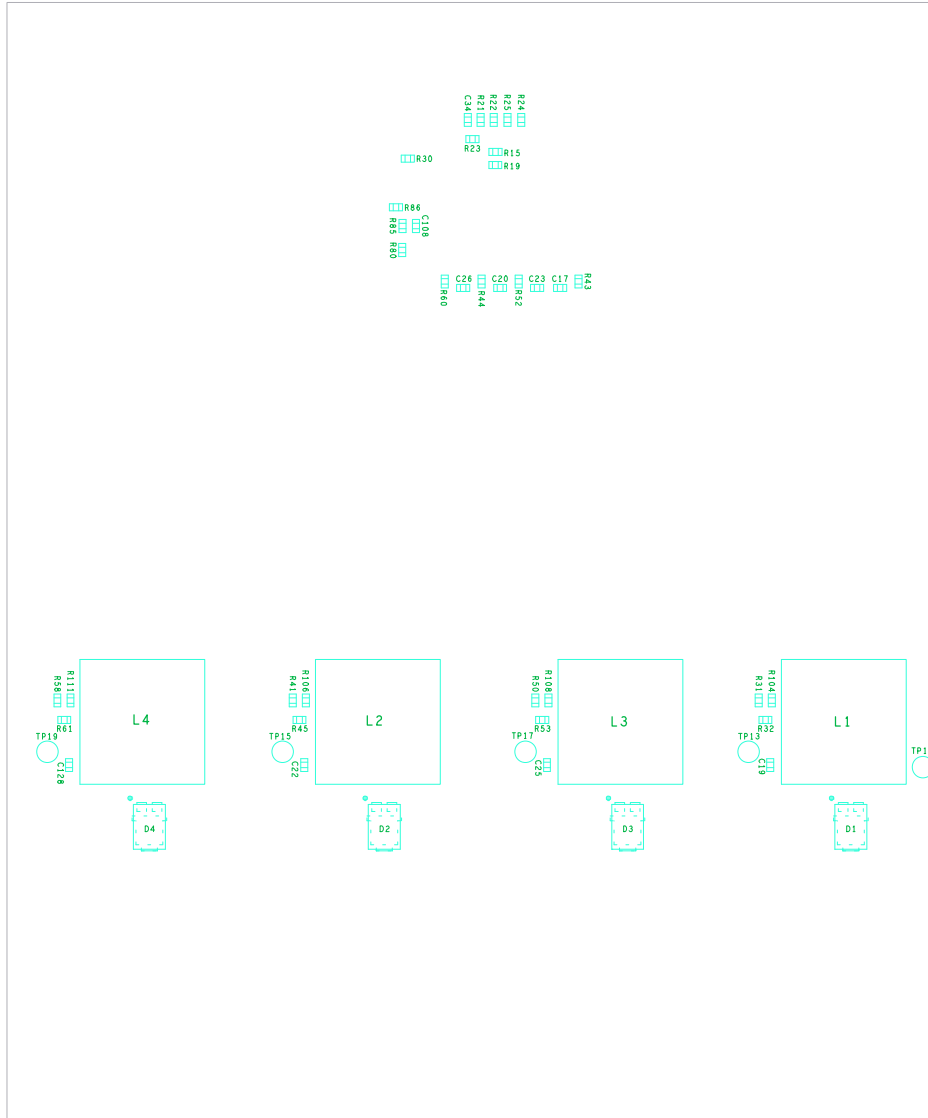

FIGURE 22. ASSEMBLY BOTTOM

Intersil Corporation reserves the right to make changes in circuit design, software and/or specifications at any time without notice. Accordingly, the reader is cautioned to verify that the Application Note or Technical Brief is current before proceeding.

For information regarding Intersil Corporation and its products, see www.intersil.com