

ISL78227EV1Z

Evaluation Board User Guide

UG064
Rev 0.00
January 6, 2016

Description

The ISL78227EV1Z board demonstrates the 2-phase synchronous boost operation of the [ISL78227](#). It verifies the high efficiency of synchronous boost operation and all the features of the IC including input Constant Current (CC) control, analog/digital tracking, diode emulation, phase drooping, etc.

Specifications

This board has been configured and optimized for the following operating conditions. Refer to [“Operating Range” on page 3](#) for more detailed descriptions.

- VIN_MIN = 7.5V (or lower, refer to [“Operating Range”](#))
- VIN_TYP = 12V
- VIN_MAX = 30V (typical)
- VOUT = 36V (typical)
- IOUT_MAX = 12A (typical)
- IIN_AVG_MAX = 41.5A (typical)
- f_{sw} = 200kHz

Key Features

- Input/output voltage withstands 55V DC and 60V transients
- Input average Constant Current (CC) control loop
- PWM and analog track functions
- Forced PWM operation with negative current limiting
- External synchronization
- Selectable Continuous Conduction Mode (CCM), Diode Emulation (DE) and Phase Drooping (PH_DROP) modes
- Comprehensive protections
- Selectable Hiccup or Latch-off fault responses
- Boards can be stacked for parallel operations
- Monitoring test points for key signals

References

- [ISL78227 Datasheet](#)

Ordering Information

PART NUMBER	DESCRIPTION
ISL78227EV1Z	ISL78227 Evaluation Board

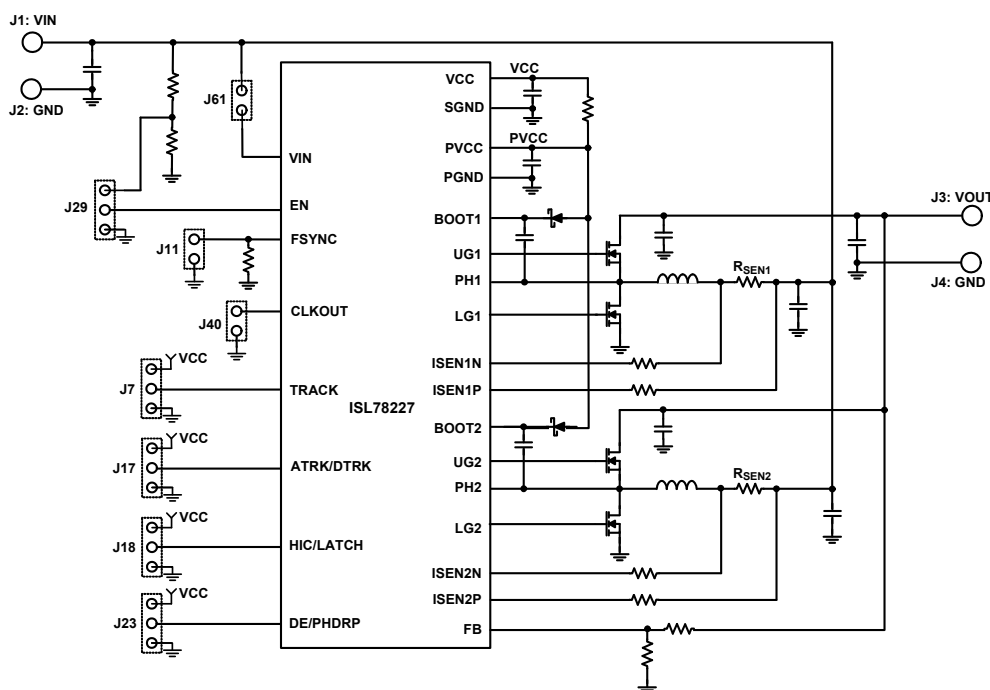

FIGURE 1. ISL78227EV1Z BLOCK DIAGRAM

ISL78227EV1Z Evaluation Board

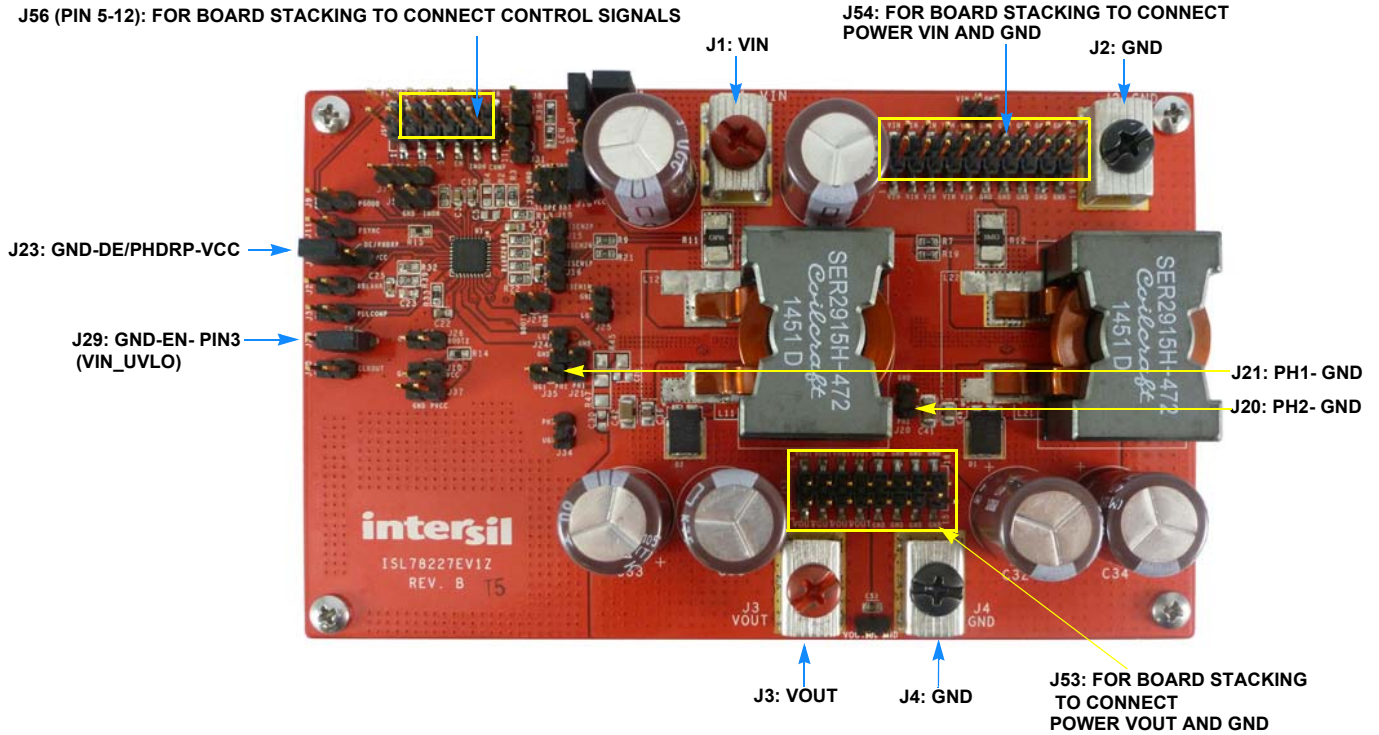

FIGURE 2. TOP VIEW OF THE ISL78227EV1Z

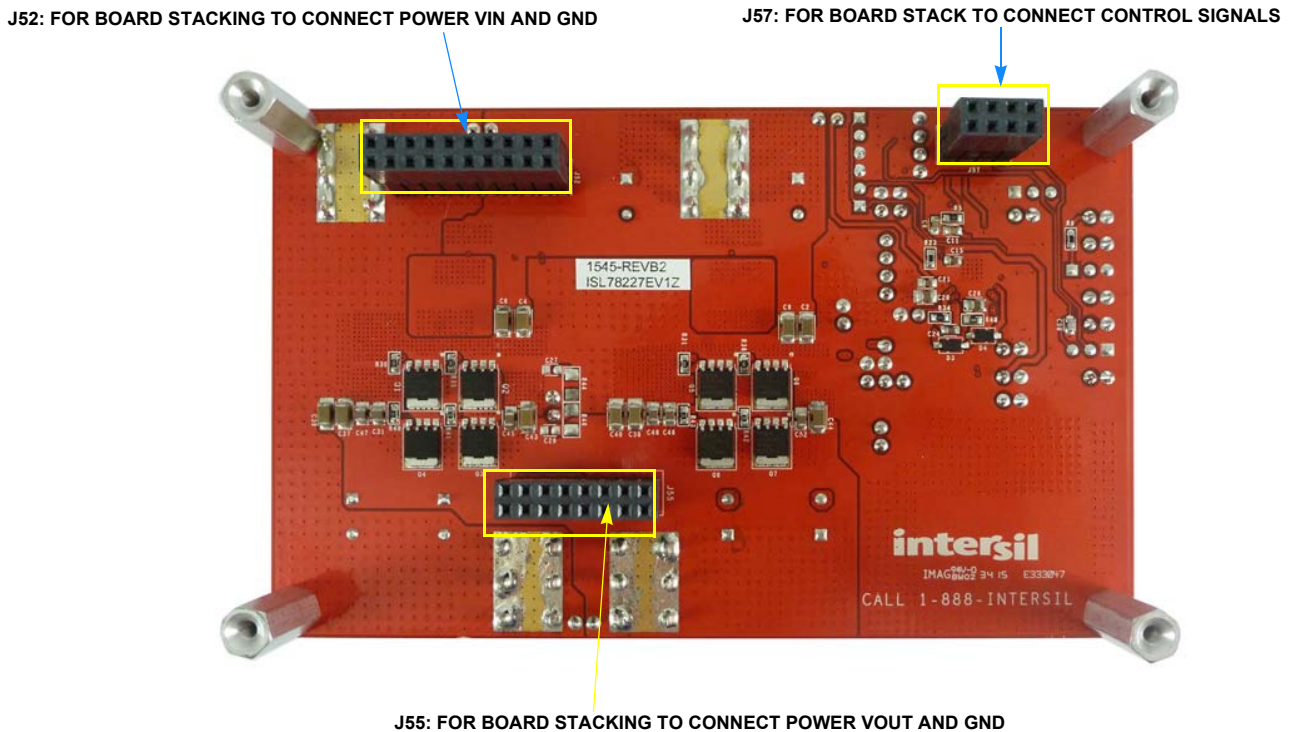

FIGURE 3. BOTTOM VIEW OF THE ISL78227EV1Z

Recommended Equipment

- 0V to 60V power supply with 45A source current capability
- 0V to 5V power supply with 0.5A source current capability
- Load capable of 20A (or up to 30A)
- Function generator
- 2 to 4 Digital Multimeters (DMM)
- 1 oscilloscope

Functional Description

The ISL78227EV1Z evaluation board pictures are shown in [Figures 2](#) and [3](#). The board supports a quick evaluation of various features of the ISL78227.

The ISL78227EV1Z demonstrates ISL78227 as the controller of a high efficiency 2-phase synchronous boost.

The ISL78227EV1Z demonstrates the IC's unique function of accepting either digital or analog signals for the user to adjust the reference voltage externally.

The ISL78227EV1Z demonstrates the ISL78227's unique feature of average Constant Current (CC) control for the input current. The board can have the average input current as a controlled constant without shutdown, which helps the user to optimize the system with the power devices' capability that is fully utilized by the well-controlled constant input current.

The ISL78227EV1Z has connector options to select Continuous Conduction Mode (CCM), Diode Emulation (DE) and Phase Dropping (PH_DROP) modes.

Two ISL78227EV1Z evaluation boards can be stacked to demonstrate 2 ICs operating in parallel to control a 4-phase boost regulator.

Operating Range

- $V_{IN_MIN} = 7.5V$ or lower.
 - The board starts up when the input voltage, V_{IN} , rises above 10V and shuts down when V_{IN} falls below 7.5V. This 10V/7.5V input voltage UVLO is determined by the resistor divider (R_{36} , R_{37}) from the input voltage to the EN pin. These V_{IN} UVLO thresholds can be modified by changing the resistor divider values.
 - With the ISL78227's EN pin (through J29's center pin) directly controlled by the external supply instead of the V_{IN} UVLO described above, the board can operate at V_{IN} as low as 5V to 6V while the output power is limited by I_{IN_MAX} (41.5A typical, controlled by the input CC control).

- $V_{IN_TYP} = 12V$
- $V_{IN_MAX} = 30V$ (typical). To keep V_{OUT} regulated at 36V, the maximum input voltage is typically 30V determined by the minimum duty cycle.
- $V_{OUT} = 36V$ (typical)
- $I_{OUT_MAX} = 12A$ (typical at 12V V_{IN} , depending on V_{IN} due to the $I_{IN_AVG_MAX}$ being 41.5A controlled by the input CC control)
- $I_{IN_AVG_MAX} = 41.5A$ (typical, controlled by the input CC control)
- $f_{SW} = 200kHz$
- The board is set in CCM mode by default with J23's Pin 2 (DE/PHDRP) shorted to Pin 3 (GND) by the jumper.
- The board is set to have Hiccup mode as the fault protection response with J18's Pin 2 (HIC/LATCH) connected to VCC by the jumper.
- Per phase inductor's peak current limit is set at 38.5A (OC1: cycle-by-cycle, continuously switching).
- Per phase inductor's peak current fault protection is set at 48.5A (OC2_PEAk fault, Hiccup response set by J18's default setting).
- The board is set to accept an analog signal as the input (J17's Pin 2 (ATrk/DTRK) shorted to VCC by the jumper).

Quick Guide for Configurations and Test Points

[Figures 4](#) and [5](#) show the schematics of this evaluation board. The "Bill of Materials" are listed on [page 12](#). The layout information of the board can be found in [Figures 10](#) through [19](#).

[Table 1 on page 10](#) shows the detailed descriptions for all the connectors/monitor pins.

Key signals such as VCC, PVCC, SS, FB, COMP, EN, PGOOD, CLKOUT, PHx, LGx, etc., are available at the monitoring pins for easy measurement. [Figures 20](#) through [47](#) show the performance data taken with this evaluation board at the default configurations.

The board setting can be changed by configuring the connection of the corresponding connectors (header/pin type) or replacing the resistors and/or capacitors populated on the board. Some examples are described as follows:

- J23 is for selection of CCM/DE/PH_DROP modes (refer to [Table 2](#) in the [ISL78227](#) datasheet). The board is set in CCM mode by default. Do Not short J23 on both sides at the same time.
 - Short J23's Pin 2 (DE/PHDRP) to VCC with jumper for the DE mode
 - Leave all J23's 3 pins open for DE plus Phase Dropping mode
 - Short J23's Pin 2 (DE/PHDRP) to GND for the CCM mode (default board setting)

- J18 is for selection of the fault protection response modes (Hiccup/Latch-off). Do Not short J18 on both sides at the same time.
 - Short J18's Pin 2 (HIC/LATCH) to VCC with the jumper for default Hiccup fault response (default board setting)
 - Short J18's Pin 2 (HIC/LATCH) to GND with the jumper for default Latch-off fault response
- The switching frequency on the ISL78227EV1Z is fixed at 200kHz. To change the frequency, replace R₁₅, which is connected between FSYNC and GND. Please refer to the "Oscillator and Synchronization" section in the [ISL78227](#) datasheet for detail. The switching clock can be synchronized with an external clock source applied at the FSYNC pin (through J11). The external clock frequency range can be 50kHz to 1.1MHz.
- The output voltage of ISL78227EV1Z is fixed at 36V in default setting. This can be changed by replacing the feedback resistor R₃ or R₂. When changing the feedback resistor, the maximum output current will be changed accordingly because the maximum input current is controlled to be fixed by input CC.
- The input average CC limit (41.5A typical) can be adjusted by replacing the resistor R₁, which is connected to IMON pin. For the setting of the average CC control, please refer to "Average Current Sense for 2 Phases - IMON" and "Constant Current Control (CC)" sections in the [ISL78227](#) datasheet.
- The per phase inductor's cycle-by-cycle peak current limit (OC1) can be changed by replacing the current sense resistor R₁₁ (R₁₂) and/or current sense gain setting resistors R₉, R₁₀, R₂₁, R₂₂ (R₇, R₈, R₁₉, R₂₀) for the respective phases. Please refer to "Current Sensing" and "Cycle-by-Cycle Peak Overcurrent Limiting/Protection" sections in [ISL78227](#) datasheet for details. Note: if these resistors are changed, the R₁ may need to be changed accordingly to keep the desired CC control level.

Quick Start Guide

Setup of Test Equipment

As described in "[Recommended Equipment](#)" on [page 3](#), prepare 2 power supplies, 1 electronic load, 2 - 4 DMMs and 1 oscilloscope.

- The first power supply 60V/45A (V_{IN} power supply) will be used for the V_{IN} power rail.
- The second power supply 5V/0.5A (EN power supply) will be used to supply bias for EN. This power supply is not necessary if EN is connected to V_{IN} resistor divider with J29's Pin 2 shorted with Pin 3 by the jumper.
- The electronic load (or resistive load) will be used as the load for V_{OUT} and should have a capability to sink 20A (or up to 30A).
- The DMMs will be used to monitor output voltage, input voltage and other signals such as PVCC, VCC, IMON, FB, etc. if interested.

External Connections and Setup Before Start-Up

- Connect the VIN power supply between VIN (J1) and GND (J2). Before start-up, typically set the VIN power supply voltage to 12V. The power supply output should remain off before start-up.
- Connect the EN power supply (if used) between EN and GND using J29's Pin 2 (EN) and GND (Pin 1). Typically, set the EN power supply voltage in range of 3V to 5V. The power supply output should remain off before start-up.
- Connect the electronic load between VOUT (J3) and GND (J4). Set the electronic load to 0A for the first start-up. The load should remain off before start-up.
- Place the DMMs appropriately where the signals are to be measured. The input and output voltage can be measured using J6 and J30. (Note: To measure the voltage of high current nodes, it is recommended to use a Kelvin connection to avoid the effect of parasitic resistances of the connections. These connections are supplied at J6 and J30.)
- Set the oscilloscope probes to monitor PH1 (J21), PH2 (J20), VOUT (J30), IMON (J5), or any other signals.

Start-Up and Measurement

On the ISL78227EV1Z, the user can select one of the 3 basic operation modes of CCM/DE/PH_DROP (refer to Table 2 in the [ISL78227](#) datasheet) by configuring J23.

1. **CCM mode** - The ISL78227EV1Z board is set in CCM mode by default with J23's Pin 2 (DE/PHDRP) shorted to GND with the jumper.
 - Before powering up, keep EN power supply and VIN power supply outputs off. Keep the electronic load off.
 - Set VIN power supply to 12V (or desired voltage). Turn on the output of VIN power supply.
 - Confirm the VIN voltage of the evaluation board is correct.
 - Confirm the supply current of VIN power supply is small.
 - Enable the output of the EN power supply.
 - Confirm the evaluation board output voltage is 36V (typical).
 - Confirm the CCM switching pulses at PH1 and PH2. The PH1 (PH2) switching frequency is 200kHz (typical).
 - Increase the load to heavy load - Slowly increase the load from 0A to 10A. Keep the input voltage around 12V. The input current is around 31A. Check to see if PH1/PH2 waveforms are normal and if V_{OUT} is regulated at 36V.
 - Increase the load to CC mode - Continue to slowly increase the load. At the same time, the user can monitor the IMON pin voltage using the DMM or oscilloscope. When the load increases to around 14A, V_{OUT} starts to drop below 36V (at around 34.5V) and the IMON pin voltage reaches 1.6V. This shows the CC loop is working and the input current is controlled to be fixed at 41.5A (typical). When the load current continues to increase, the input current is fixed at 41.5A (controlled by the CC loop) and the V_{OUT} continues to drop. The heavier the load, the lower the V_{OUT}, which is the characteristic

of constant power (V_{IN} is kept at 12V fixed and the input current is controlled at 41.5A fixed).

- Power off
 - Turn off the load to 0A
 - Turn off the EN power supply
 - Power down VIN power supply
- 2. **DE mode plus Phase Drop mode** - Remove the jumper at J23 and keep J23 open. The ISL78227's DE/PHDRP pin is floating and the IC is set in DE+PH_DROP mode.
- Enable the system and repeat the procedures in Step 1.
- Confirm the input voltage, output voltage, load current and operation mode.
 - At no load, only Phase 1 is switching and it is pulse skipping. Phase 2 is dropped and not switching.
 - When the load increases to a level when the IMON voltage is higher than 1.15V, Phase 2 is added and switching.
 - CC control at overloading has the same scenario described in Step 1.
- 3. **DE mode** - Short J23's Pin 2 (DE/PHDRP) and Pin 1 (VCC) with a jumper to set the IC in DE Mode. Leave J23 Pin 3 (GND) floating.
- Enable the system and repeat the procedures in Step 1.
- Confirm the input voltage, output voltage, load current and operation mode.
 - At no load, either Phase 1, or Phase 2, or both is/are switching at Discontinuous Conduction Mode (DCM) and pulse skipping.
 - When the load increases from 0 to a certain light load, both Phase 1 and Phase 2 are switching at DCM mode.
 - When the load is higher than a certain level (inductor current is higher than the boundary current between DCM and CCM), Phase 1 and Phase 2 will be switching at CCM mode.
 - CC control at overloading has the same scenario described in Step 1.

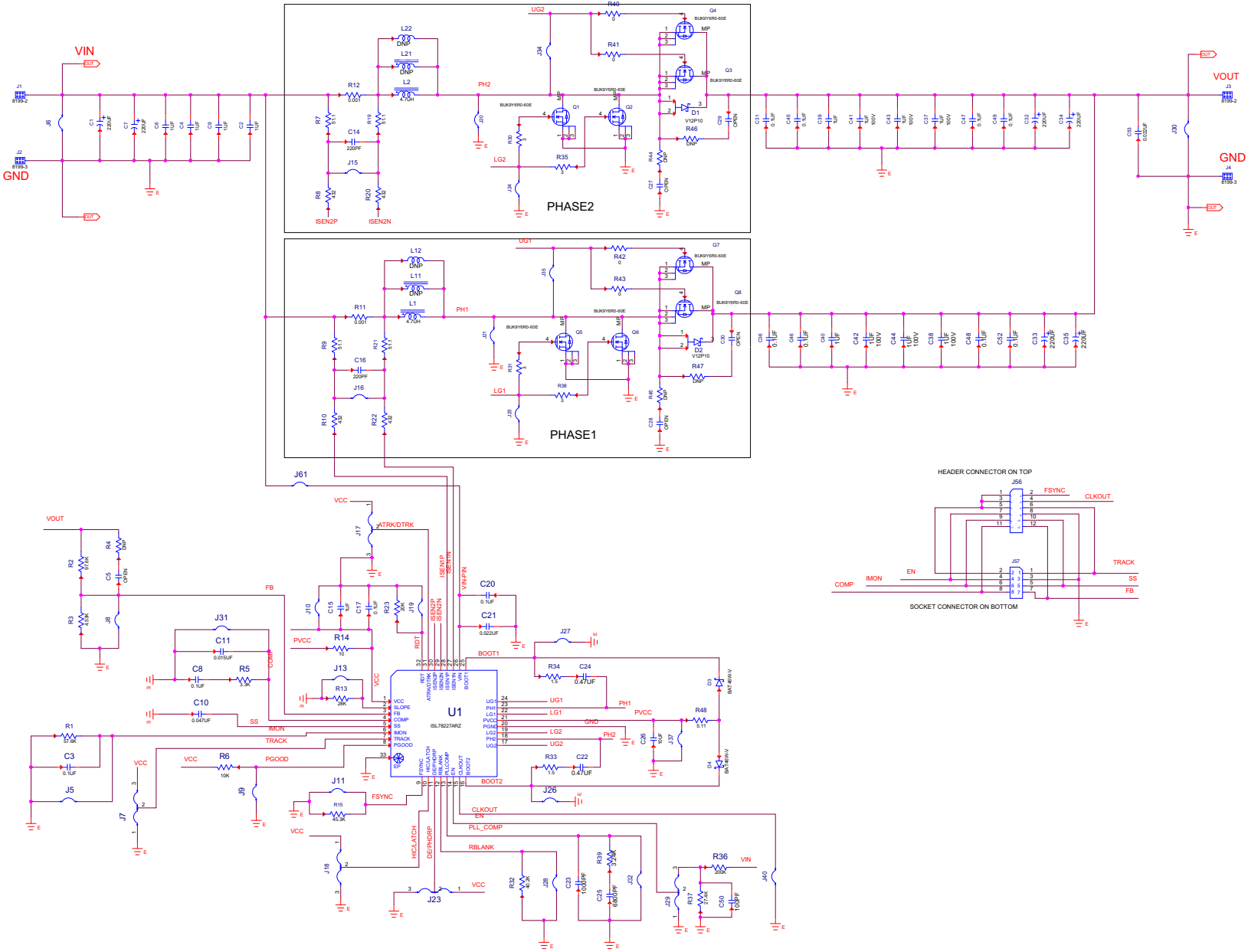

FIGURE 4. ISL78227EV1Z BOARD SCHEMATIC - PAGE 1

ISL78227EV1Z Schematic

ISL78227EV1Z Schematic (Continued)

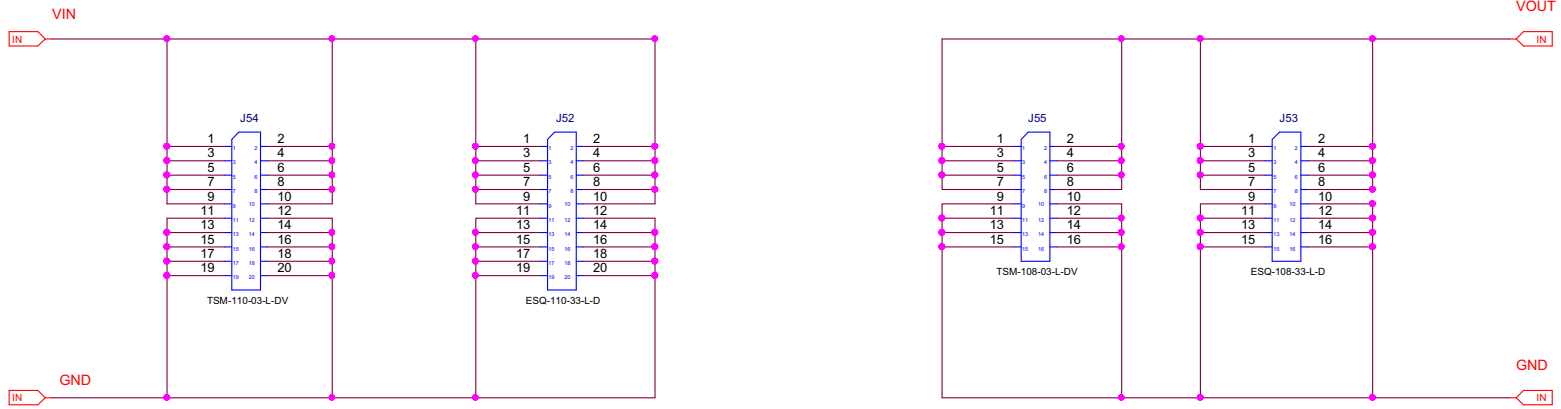

FIGURE 5. ISL78227EV1Z BOARD SCHEMATIC - PAGE 2

Stack Two Boards for Parallel Operation

Two ISL78227EV1Z boards can be stacked. This allows for two ISL78227s to operate in parallel achieving a 4-phase interleaved boost regulator.

The ISL78227EV1Z has connectors to stack multiple boards for parallel operation. Figures 6 and 7 show two ISL78227EV1Z boards stacked. To stack two boards properly, align the two boards with one on top of the other, and plug in the 3 groups of connectors described in the following (first 3 bullet points). Directions for stacking board #1 on top of board #2:

- Plug board #2's J54 (header/pin type, on board top) into board #1's J52 (socket type, on board bottom) to connect both boards' inputs together.
- Plug board #2's J53 (header/pin type, on board top) into board #1's J55 (socket type, on board bottom) to connect both boards' outputs together.
- Plug board #2's J56's Pin 5-12 (header/pin type) into board #1's J57 (socket type, 8 pins, on board bottom) to connect both boards' signals needed for the boards' parallel

operation, e.g., TRACK, GND, EN, SS, IMON, FB and COMP signals.

- Short board #1's J56's Pin 3 and Pin 4 with the jumper to connect board #1's CLKOUT signal to the board #2's FSYNC input.
- Short board #2's J56's Pin 1 and Pin 2 with the jumper to connect board #2's FSYNC input to the board #1's CLKOUT signal.
- External setup:
 - Connect the input V_{IN} power supply to J1/J2 of both boards.
 - Connect the load to J3/J4 of both boards. Since both boards' EN pin signals are tied together, only one external EN power supply (3V to 5V) is needed for enable/disable through J29's Pins 1-2 of top board.
- Power Up:
 - Keep EN power supply off.
 - Turn on the V_{IN} power supply.
 - Then turn on the EN power supply.
- Power Down:
 - Turn off the EN power supply.
 - Then turn off the V_{IN} power supply.

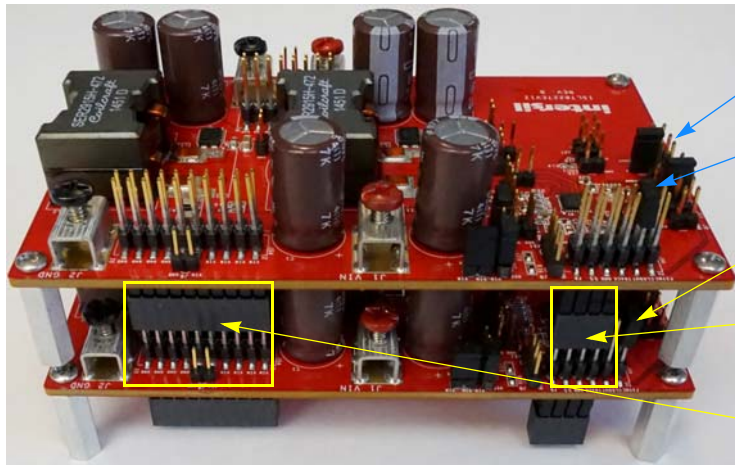

Connect EN power supply (3V to 5V) to top board's J29's Pin 2 (EN) and Pin 1 (GND) to enable/disable the boards. Note: Remove both boards' default jumpers at J29's Pin 2 to Pin 3.

Short one board's (top board) J56's Pin 3 and Pin 4 with jumper to connect its CLKOUT signal to the other board's FSYNC input.

Short one board (bottom board) J56's Pin 1 and Pin 2 with jumper to connect its FSYNC input to the other board's CLKOUT signal.

Bottom board's J56's Pins 5-12 (header/pin type) plugged into top board's J57 (socket type) to connect both boards' connect control signals

Bottom board's J54 (header/pin type) plugged into top board's J52 (socket type) to connect both boards' power inputs (V_{IN} and GND) together.

FIGURE 6. STACK TWO ISL78227EV1Z FOR PARALLEL OPERATION TO ACHIEVE 4-PHASE INTERLEAVED BOOST REGULATOR (VIEW FROM INPUTS SIDE)

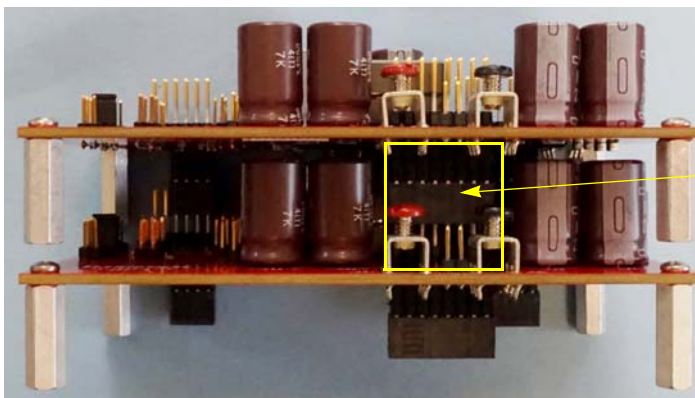

Bottom board's J53 (header/pin type) plugged into top board's J55 (socket type) to connect both boards' power outputs (V_{OUT} and GND) together.

FIGURE 7. STACK TWO ISL78227EV1Z FOR PARALLEL OPERATION TO ACHIEVE 4-PHASE INTERLEAVED BOOST REGULATOR (VIEW FROM OUTPUTS SIDE)

PCB Layout Guidelines

For a DC/DC converter design, the PCB layout is very important to ensure the desired performance.

1. Place input ceramic capacitors as close as possible to the IC's VIN and PGND/SGND pins.
2. Place the output ceramic capacitors as close as possible to the power MOSFET. Keep this loop (output ceramic capacitor and MOSFETs for each phase) as small as possible to reduce voltage spikes induced by the trace parasitic inductances when MOSFETs are switching ON and OFF.
3. Place the output aluminum capacitors close to power MOSFETs also.
4. Keep the phase node copper area small but large enough to handle the load current.
5. Place the input aluminum and some ceramic capacitors close to the input inductors and power MOSFETs.
6. Place multiple vias under the thermal pad of the IC. The thermal pad should be connected to the ground copper plane with as large an area as possible in multiple layers to effectively reduce the thermal impedance. [Figure 8](#) shows the layout example for vias in the IC bottom pad.

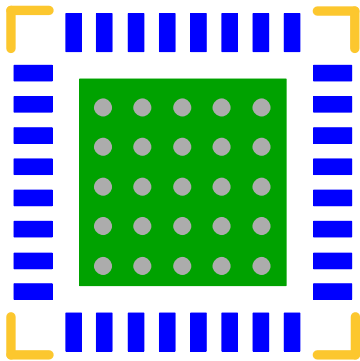

FIGURE 8. RECOMMENDED LAYOUT PATTERN FOR VIAS IN THE IC BOTTOM PAD

7. Place the 10 μ F decoupling ceramic capacitor at the PVCC pin and as close as possible to the IC. Put multiple vias close to the ground pad of this capacitor.

8. Place the 1 μ F decoupling ceramic capacitor at the VCC pin and as close as possible to the IC. Put multiple vias close to the ground pad of this capacitor.
9. Keep the bootstrap capacitor as close as possible to the IC.
10. Keep the driver traces as short as possible and with relatively large width (25 mil to 40 mil is recommended), and avoid using via or minimal number of vias in the driver path to achieve the lowest impedance.
11. Place the current sense setting resistors and the filter capacitor (shown as R_{SETXB} , R_{BIASXB} and C_{ISENX} in the [ISL78227](#) datasheet) as close as possible to the IC. Keep each pair of the traces close to each other to avoid undesired switching noise injections.
12. The current sensing traces must be laid out very carefully since they carry tiny signals with only tens of mV.
13. For the current sensing traces close to the power sense resistor (R_{SENx}), the layout pattern shown in [Figure 9](#) is recommended. Assuming the R_{SENx} is placed in the top layer (red), route one current sense connection from the middle of one R_{SENx} pad in the top layer under the resistor (red trace). For the other current sensing trace, from the middle of the other pad on R_{SENx} in top layer, after a short distance, via down to the second layer and route this trace right under the top layer current sense trace.

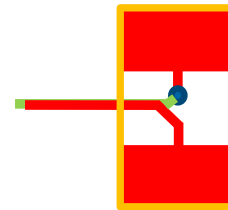

FIGURE 9. RECOMMENDED LAYOUT PATTERN FOR CURRENT SENSE TRACES REGULATOR

14. Keep the current sensing traces far from the noisy traces like gate driving traces (LGx, UGx and PHx), phase nodes in power stage, BOOTx signals, output switching pulse currents, driving bias traces and input inductor ripple current signals, etc.

TABLE 1. CONNECTOR/MONITOR-PIN DESCRIPTIONS

CONNECTOR /TEST POINT	SIGNAL NAME	DESCRIPTION
J1	VIN	Positive power input terminal for the boost regulator input.
J2	GND	Power ground input terminal for the boost regulator input.
J3	VOUT	Positive power output terminal for the boost regulator output.
J4	GND	Power ground output terminal for the boost regulator output.
J5	GND - IMON	Test point to monitor the IMON voltage. A jumper can be added to short the IMON pin to ground to disable the constant current limit (41.5A typical). To adjust the constant current control level, replace resistor (R ₁) between IMON and GND.
J6	GND, VIN	Test point to monitor input voltage VIN (Do Not short with jumper).
J7	GND (Pin 1), TRACK (Pin 2), VCC (Pin 3)	Pin 2 is for monitoring TRACK voltage. It can also be used to inject a tracking reference signal to the TRACK pin. When the TRACK function is not used, short Pin 2 (TRACK) and Pin 2 (VCC) with the jumper. Do Not short both sides at the same time.
J8	GND, FB	Test point to monitor FB voltage (Do Not short with jumper).
J9	GND, PGOOD	Test point to monitor PGOOD voltage.
J10	GND, VCC	Test point to monitor VCC voltage (Do Not short with jumper).
J11	GND, FSYNC	External synchronization clock input terminal or test point for the FSYNC pin voltage (Do Not short with jumper).
J13	SLOPE, GND	Test point to monitor IMON voltage (Do Not short with jumper).
J15		Test points to monitor Phase 2 current sense input signals.
J16		Test points to monitor Phase 1 current sense input signals.
J17	VCC (Pin 1), ATRK/DTRK (Pin 2), GND (Pin 3)	TRACK input mode (analog tracking or digital tracking input) selection pins. Connect to VCC with jumper for analog tracking input or short to GND for digital tracking input (Do Not short both sides at the same time).
J18	VCC (Pin 1), HIC/LATCH (Pin 2), GND (Pin 3)	Default fault protection response mode (Hiccup/Latch-off) selection pins. Connect to VCC with jumper for Hiccup fault response as default or short to GND for Latch-off fault response as default (Do Not short both sides at the same time).
J19	RDT, GND	Test point to monitor RDT voltage (Do Not short with jumper).
J20	GND, PH2	Test point to monitor the PH2 waveform (Do Not short with jumper).
J21	GND, PH1	Test point to monitor the PH1 waveform (Do Not short with jumper).
J23	VCC (Pin 1), DE/PHDRP (Pin 2), GND (Pin 3)	CCM/DE/PH_DROP modes selection pins. Connect to VCC with jumper for DE mode; Leave all the 3 pins open for DE plus Phase Dropping mode; Short to GND for CCM mode (Do Not short both sides at the same time).
J24	GND, LG2	Test point to monitor the LG2 waveform (Do Not short with jumper).
J25	GND, LG1	Test point to monitor the LG1 waveform (Do Not short with jumper).
J26	GND, BOOT2	Test point to monitor the BOOT2 waveform (Do Not short with jumper).
J27	GND, BOOT1	Test point to monitor the BOOT1 waveform (Do Not short with jumper).
J28	GND, RBLANK	Test point to monitor RBLANK voltage (Do Not short with jumper).
J29	GND (Pin 1), EN (Pin 2), Pin 3 (For VIN_UVLO)	Enable/Disable options. Pin 2 (EN) can be used to apply external signal to enable and disable the IC. To connect Pin 2 (EN) to Pin 3 with jumper connects the resistor divider (R ₃₆ , R ₃₇ , dividing input voltage) output to the EN pin, in such a way the part has an input voltage UVLO. The board starts up when input voltage V _{IN} > 10V and shuts down when V _{IN} < 7.5V. This 10V/7.5V V _{IN} UVLO setting can be changed by changing the resistor divider values. Do Not short both sides at the same time.
J30	GND, VOUT	Test point to monitor output voltage VOUT (Do Not short with jumper).

TABLE 1. CONNECTOR/MONITOR-PIN DESCRIPTIONS (Continued)

CONNECTOR /TEST POINT	SIGNAL NAME	DESCRIPTION
J31	COMP, GND	Test point to monitor COMP voltage (Do Not short with jumper).
J32	GND, PLLCOMP	Test point to monitor PLLCOMP voltage (Do Not short with jumper).
J34	PH2, UG2	Test point to monitor UG2-PH2 voltage waveforms (Do Not short with jumper). Differential voltage probe is required to monitor UG2-PH2 waveforms.
J35	PH1, UG1	Test point to monitor UG1-PH1 voltage waveforms (Do Not short with jumper). Differential voltage probe is required to monitor UG1-PH1 waveforms.
J37	GND, PVCC	Test point to monitor PVCC voltage (Do Not short with jumper).
J40	GND, CLKOUT	Test point to monitor CLKOUT voltage (Do Not short with jumper).
J52	VIN, GND	Socket type connector for power input at board bottom side. It is used to stack boards. It is plugged in by J54 (header/pin type connector) of the other board.
J53	VOUT, GND	Header/pin type connector for power output at board top side. It is used to stack boards. It is plugged in by J55 (socket type connector) of the other board. Pins 1-8: V _{OUT} . Pins 9-16: GND.
J54	VIN, GND	Header/pin type connector for power input at board top side. It is used to stack boards. It is plugged to J52 (socket type connector) of the other board. Pins 1-10: V _{IN} . Pins 11-20: GND.
J55	VOUT, GND	Socket type connector for power output at board bottom side. It is used to stack boards. It is plugged in by J53 (header/pin type connector) of the other board.
J56	Pin 1: FSYNC if Pin 1 and Pin 2 shorted by jumper; CLKOUT if Pin 3 and Pin 4 shorted by jumper. Pin 2: FSYNC Pin 3: FSYNC if Pin 1 and Pin 2 shorted by jumper; CLKOUT if Pin 3 and Pin 4 shorted by jumper. Pin 4: CLKOUT Pin 5: FSYNC if Pin 1 and Pin 2 shorted by jumper; CLKOUT if Pin 3 and Pin 4 shorted by jumper. Pin 6: TRACK Pin 7: EN Pin 8: GND Pin 9: IMON Pin 10: SS Pin 11: COMP Pin 12: FB	Header/pin type connector on board top side for connections of signals needed for the boards' parallel operation. Its Pins 5-12 are used to plug into another board's J57 (socket type connector, 8 pins) with both boards stacked. Check the description in J57 for details.
J57	Pin 1: TRACK Pin 2: FSYNC if J56 Pin 1 and Pin 2 shorted by jumper; CLKOUT if J56 Pin 3 and Pin 4 shorted by jumper. Pin 3: GND Pin 4: EN Pin 5: SS Pin 6: IMON Pin 7: FB Pin 8: COMP	Socket type connector on the board's bottom side for connections of the signals needed for the boards' parallel operation. With it being plugged by Pins 5-12 of J56 (header/pin type connector) of the other board, the two boards' signals of TRACK, GND, EN, SS, IMON, FB and COMP are connected respectively. With board #1, J56 Pin 3 and Pin 4 are shorted by the jumper and board #2 J56 Pin 1 and Pin 2 are shorted by the jumper, board #1 CLKOUT is connected to board #2 FSYNC. With board #1, J56 Pin 1 and Pin 2 are shorted by the jumper and board #2 J56 Pin 3 and Pin 4 are shorted by the jumper, board #2 CLKOUT is connected to board #1 FSYNC.
J61	VIN, VIN_PIN	Short with jumper to connect input voltage to the ISL78227 IC VIN pin.

Bill of Materials

REFERENCE DESIGNATOR	MANUFACTURER PART NUMBER	MANUFACTURER	DESCRIPTION
C1, C7, C32-C35	EKZE800ELL221MK20S	UNITED CHEMI-CON	Capacitor, Alum. Electrolytic, RADIAL, 12.5X20, 220µF, 80V, 20%, ROHS
C10	Various	Various	Capacitor, Ceramic, SMD, 0603, 0.047µF, 50V, 10%, X7R, ROHS
C11	Various	Various	Capacitor, Ceramic, SMD, 0603, 0.015µF, 50V, 10%, X7R, ROHS
C14, C16	Various	Various	Capacitor, Ceramic, SMD, 0603, 220pF, 100V, 10%, X7R, ROHS
C15	Various	Various	Capacitor, Ceramic, SMD, 0603, 1.0µF, 16V, 10%, X7R, ROHS
C2, C4, C6, C9, C37-C44	Various	Various	Capacitor, Ceramic, SMD, 1206, 1µF, 100V, 10%, X7R, ROHS
C20, C31, C36, C45-C49, C52	Various	Various	Capacitor, Ceramic, SMD, 0805, 0.1µF, 100V, 10%, X7R, ROHS
C21, C53	Various	Various	Capacitor, Ceramic, SMD, 0603, 0.022µF, 100V, 10%, X7R, ROHS
C22, C24	Various	Various	Capacitor, Ceramic, SMD, 0603, 0.47µF, 16V, 10%, X7R, ROHS
C23	Various	Various	Capacitor, Ceramic, SMD, 0603, 1000pF, 50V, 10%, X7R, ROHS
C25	Various	Various	Capacitor, Ceramic, SMD, 0603, 6800pF, 50V, 10%, X7R, ROHS
C26	Various	Various	Capacitor, Ceramic, SMD, 0805, 10µF, 6.3V, 10%, X5R, ROHS
C3, C8, C17	Various	Various	Capacitor, Ceramic, SMD, 0603, 0.1µF, 50V, 10%, X7R, ROHS
C5, C27-C30			Capacitor, Ceramic, SMD, 0603, DNP-PLACE HOLDER
C50	Various	Various	Capacitor, Ceramic, SMD, 0603, 100pF, 50V, 5%, C0G, ROHS
D1, D2	V12P10-M3/86A-T	VISHAY	Diode-Schottky, SMD, TO-277A(SMPC), 100V, 12A, ROHS
D3, D4	BAT46W-E3-08-T	DIODES INC.	Diode-Schottky, SMD, SOD-123, 100V, 0.15A, ROHS
J1, J3	8199-2	KEYSTONE	CONN-SCREW TERMINAL, Through-Hole, 6P, SNAP-IN, 30A, RED, BRASS, ROHS
J2, J4	8199-3	KEYSTONE	CONN-SCREW TERMINAL, Through-Hole, 6P, SNAP-IN, 30A, BLK, BRASS, ROHS
J5, J6, J8-J11, J13, J15, J16, J19-J21, J24-J28, J30-J32, J34, J35, J37, J40, J61	69190-202HLF	BERG/FCI	Connector-Header, 1x2, RETENTIVE, 2.54mm Pitch, 0.230x 0.120, ROHS
J52	ESQ-110-33-L-D	SAMTEC	Connector-Socket, ELEVATED, Through-Hole, 2x10, DUALROW, 2.54mm Pitch, ROHS
J53	TSM-108-03-L-DV	SAMTEC	Connector-Header, SMD, 2x8, 2.54mm Pitch, VERTICAL, ROHS
J54	TSM-110-03-L-DV	SAMTEC	Connector-Header, SMD, 2x10, 2.54mm Pitch, VERTICAL, ROHS
J55	ESQ-108-33-L-D	SAMTEC	Connector-Socket, ELEVATED, Through-Hole, 2x8, DUALROW, 2.54mm Pitch, ROHS
J56	TSM-106-03-L-DV	SAMTEC	Connector-Header, SMD, 2x6, 2.54mm Pitch, VERTICAL, ROHS
J57	ESQ-104-33-L-D	SAMTEC	Connector-Socket, ELEVATED, Through-Hole, 2x4, DUALROW, 2.54mm Pitch, ROHS
J7, J17, J18, J23, J29	68000-236HLF-1X3	BERG/FCI	Connector-Header, 1x3, BREAK AWAY, 1x36, 2.54mm Pitch, ROHS

Bill of Materials (Continued)

REFERENCE DESIGNATOR	MANUFACTURER PART NUMBER	MANUFACTURER	DESCRIPTION
Jumpers shorting: J17-Pins 1-2, J18-Pins 1-2, J23-Pins 2-3, J29-Pins 2-3, J61-Pins 1-2	SPC02SYAN	SULLINS	Connector-Jumper, SHORTING, 2-PIN, BLACK, GOLD, ROHS
L1, L2	SER2915H-472KLB-T	COILCRAFT	Power Inductor, SMD, 27X19.1, 4.7µH, 20%, 1.8mΩ, ROHS
L11, L12, L21, L22	DNP		Power Inductor, SMD, DNP-PLACE HOLDER
Q1-Q8	BUK9Y6R0-60E	NXP SEMICONDUCTOR	Transistor-MOSFET , N-CHANNEL, SMD, 56LFPK, 60V, 100A, 6mΩ, ROHS
R1	Various	Various	Resistor, SMD, 0603, 57.6kΩ, 1/10W, 1%, TF, ROHS
R11, R12	ERJ-M1WTF1M0U	PANASONIC	RES-CURR.SENSE, SMD, 2512, 0.001Ω, 1W, 1%, TF, ROHS
R13	Various	Various	Resistor, SMD, 0603, 28kΩ, 1%, ROHS
R14	Various	Various	Resistor, SMD, 0603, 10Ω, 1/10W, 1%, TF, ROHS
R15	Various	Various	Resistor, SMD, 0603, 61.9kΩ, 1%, ROHS
R2	Various	Various	Resistor, SMD, 0603, 97.6kΩ, 1/10W, 1%, TF, ROHS
R23	Various	Various	Resistor, SMD, 0603, 20kΩ, 1%, ROHS
R3	Various	Various	Resistor, SMD, 0603, 4.53kΩ, 1/10W, 1%, TF, ROHS
R30, R31, R35, R38	Various	Various	Resistor, SMD, 0603, 3Ω, 1%, ROHS
R32	Various	Various	Resistor, SMD, 0603, 40.2kΩ, 1%, ROHS
R33, R34	Various	Various	Resistor, SMD, 0603, 1.5Ω, 1%, ROHS
R36	Various	Various	Resistor, SMD, 0603, 200kΩ, 1%, ROHS
R37	Various	Various	Resistor, SMD, 0603, 27.4kΩ, 1%, ROHS
R39	Various	Various	Resistor, SMD, 0603, 3.24k, 1%, ROHS
R4			Resistor, SMD, 0603, DNP-PLACE HOLDER
R40-R43	Various	Various	Resistor, SMD, 0603, 0Ω, 1/10W, TF, ROHS
R44, R45, R46, R47			Resistor, SMD, 1206, DNP-PLACE HOLDER
R48	Various	Various	Resistor, SMD, 0603, 5.11Ω, 1/10W, 1%, TF, ROHS
R5	Various	Various	Resistor, SMD, 0603, 3.3kΩ, 1%, ROHS
R6	Various	Various	Resistor, SMD, 0603, 10kΩ, 1%, ROHS
R7, R9, R19, R21	Various	Various	Resistor, SMD, 0603, 51.1Ω, 1%, ROHS
R8, R10, R20, R22	Various	Various	Resistor, SMD, 0603, 432Ω, 1%, ROHS
U1	ISL78227ARZ	INTERSIL	IC-2 PHASE BOOST CONTROLLER, 32P, WFQFN, 5x5, ROHS
	ISL78227EV1ZREVBPCB		PCB, ROHS

Board Layout

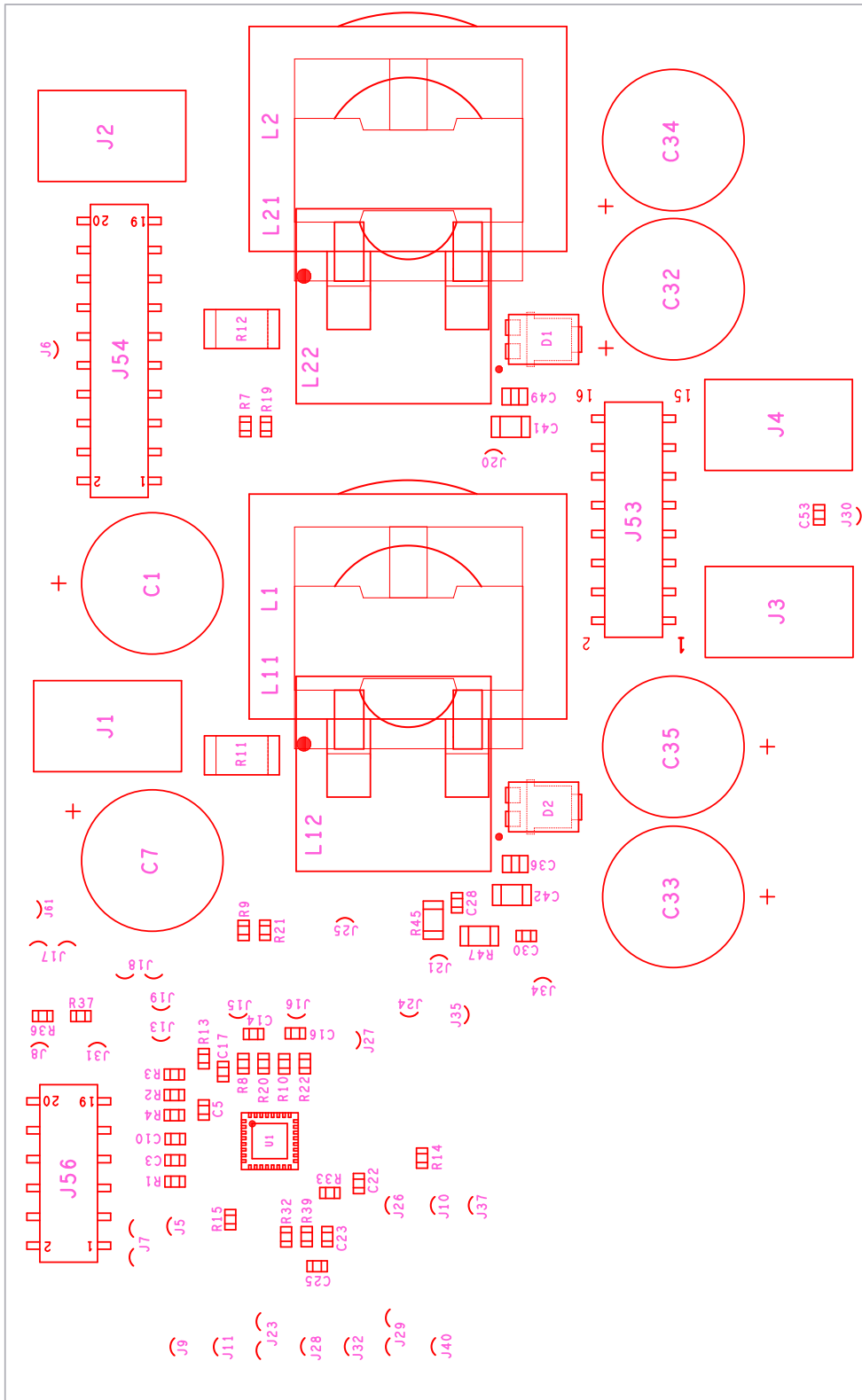

FIGURE 10. TOP COMPONENT ASSEMBLY

Board Layout (Continued)

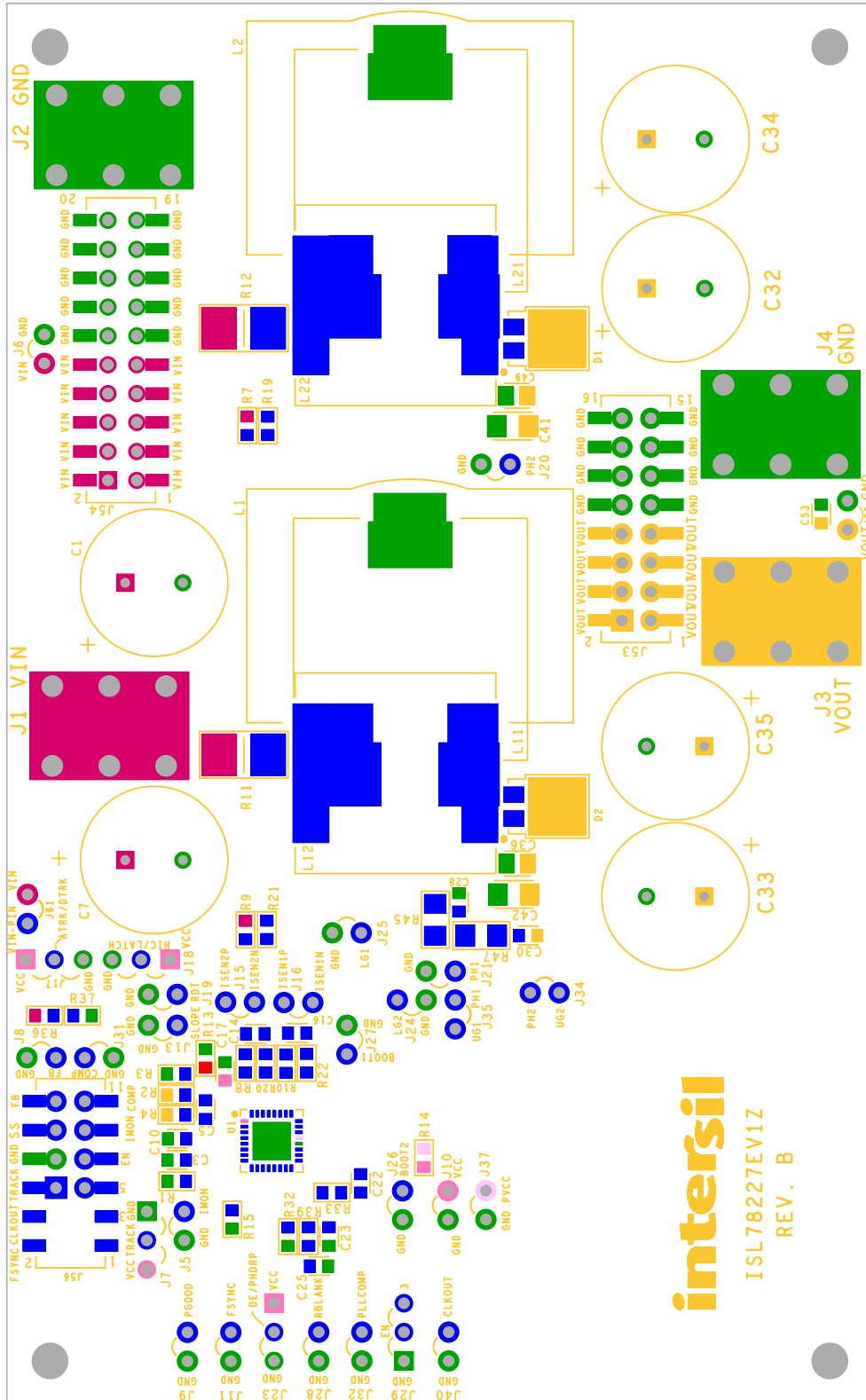

FIGURE 11. TOP SILKSCREEN AND PIN PADS

Board Layout (Continued)

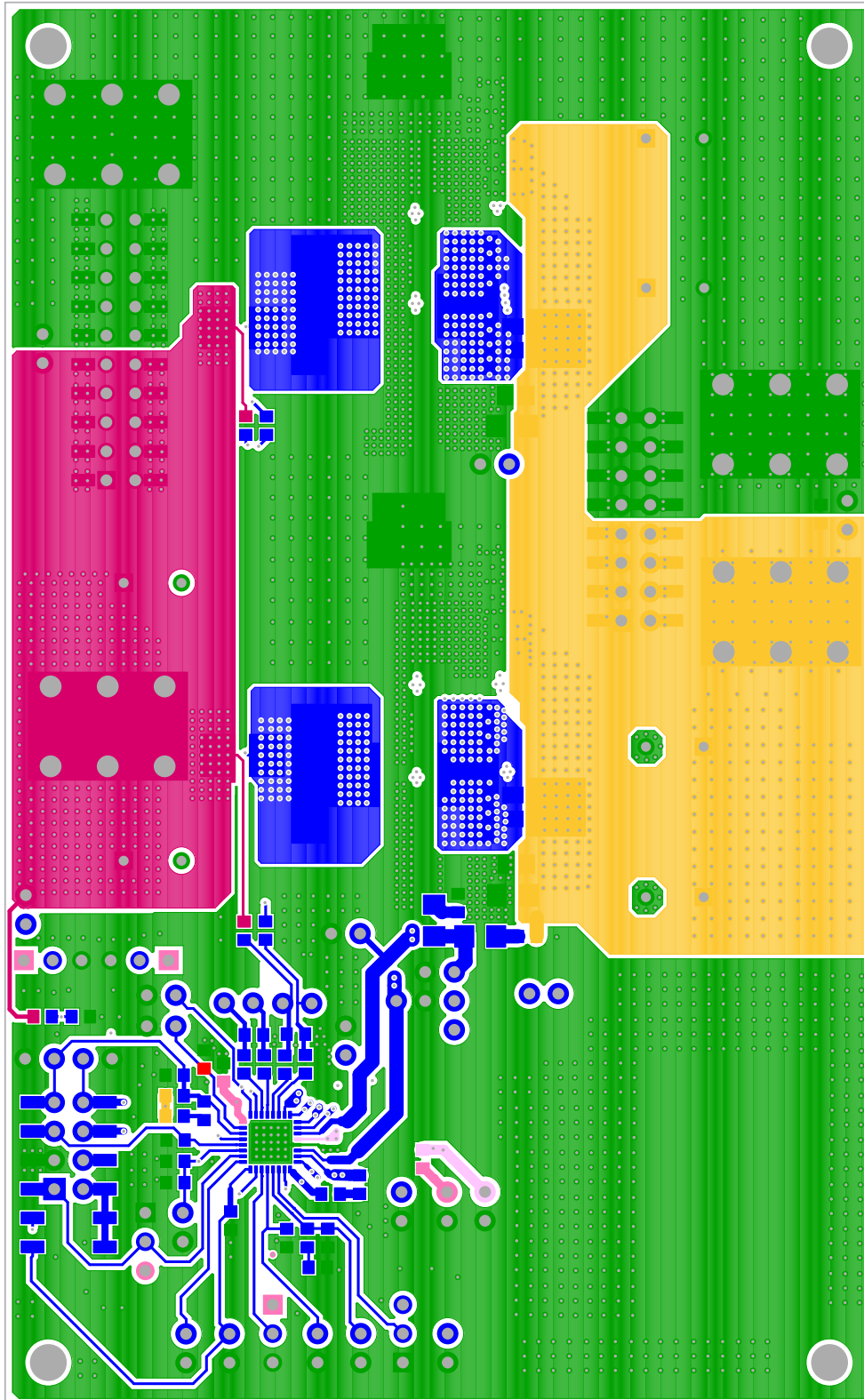

FIGURE 12. TOP LAYER

Board Layout (Continued)

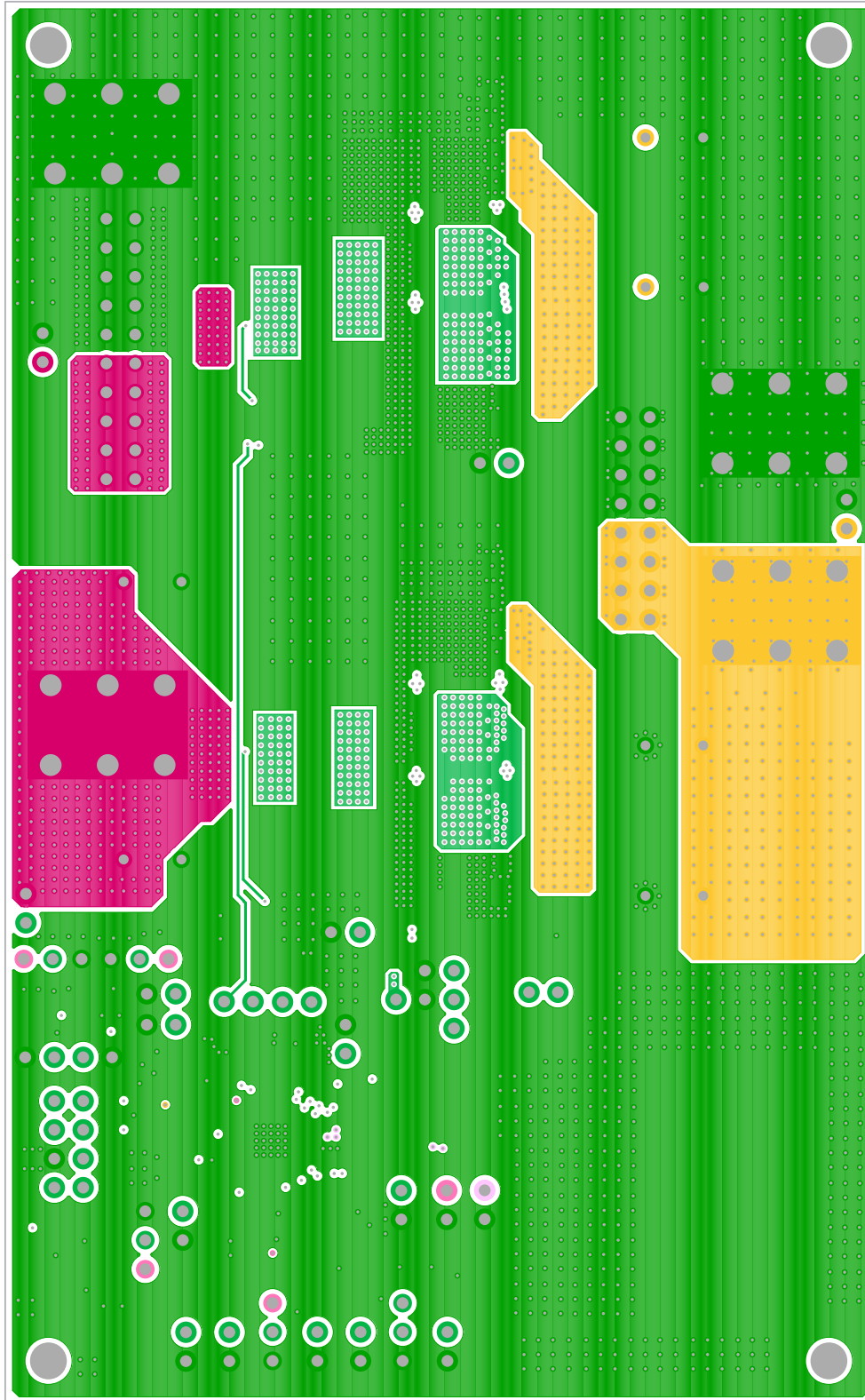

FIGURE 13. 2nd LAYER

Board Layout (Continued)

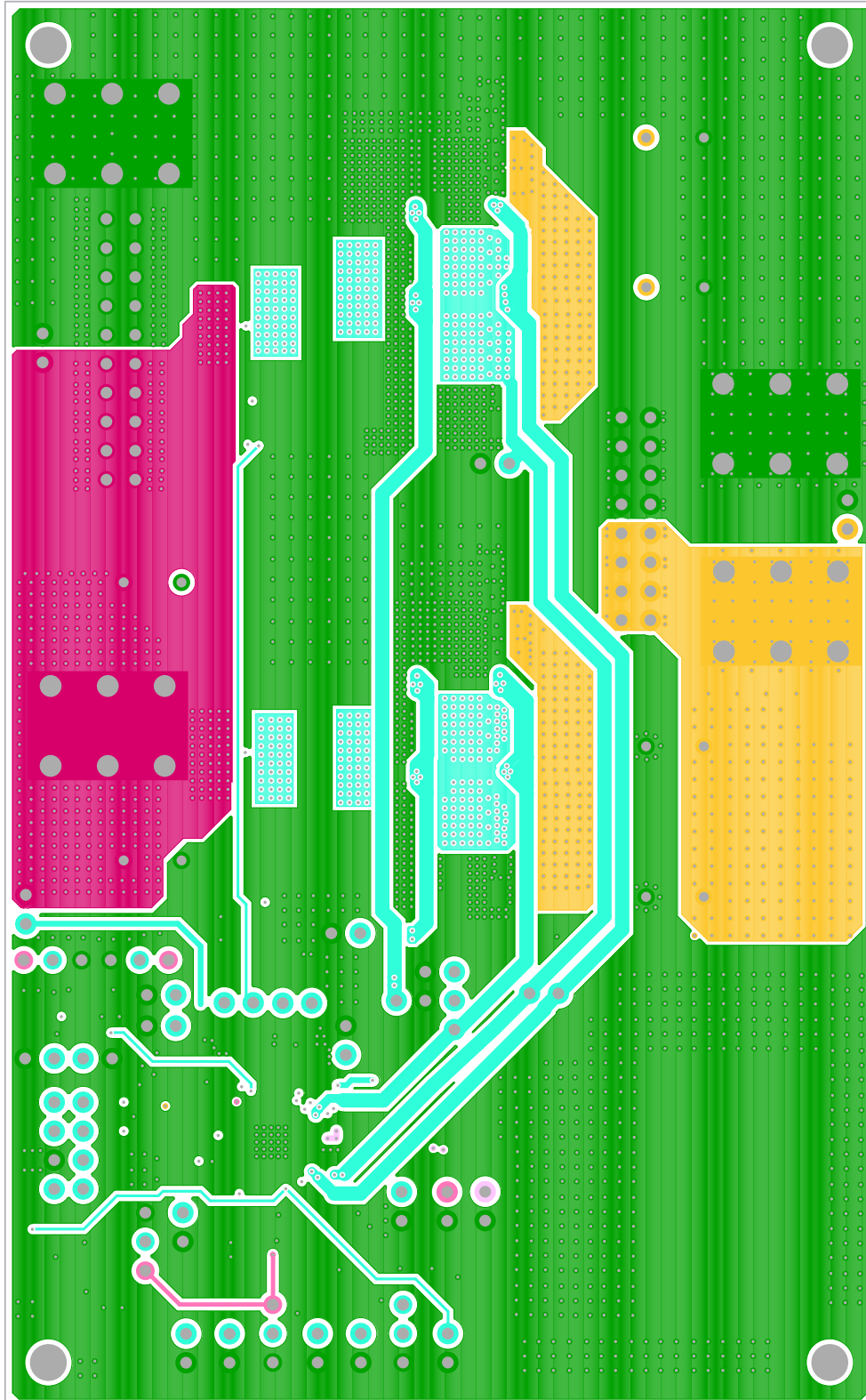

FIGURE 14. 3rd LAYER

Board Layout (Continued)

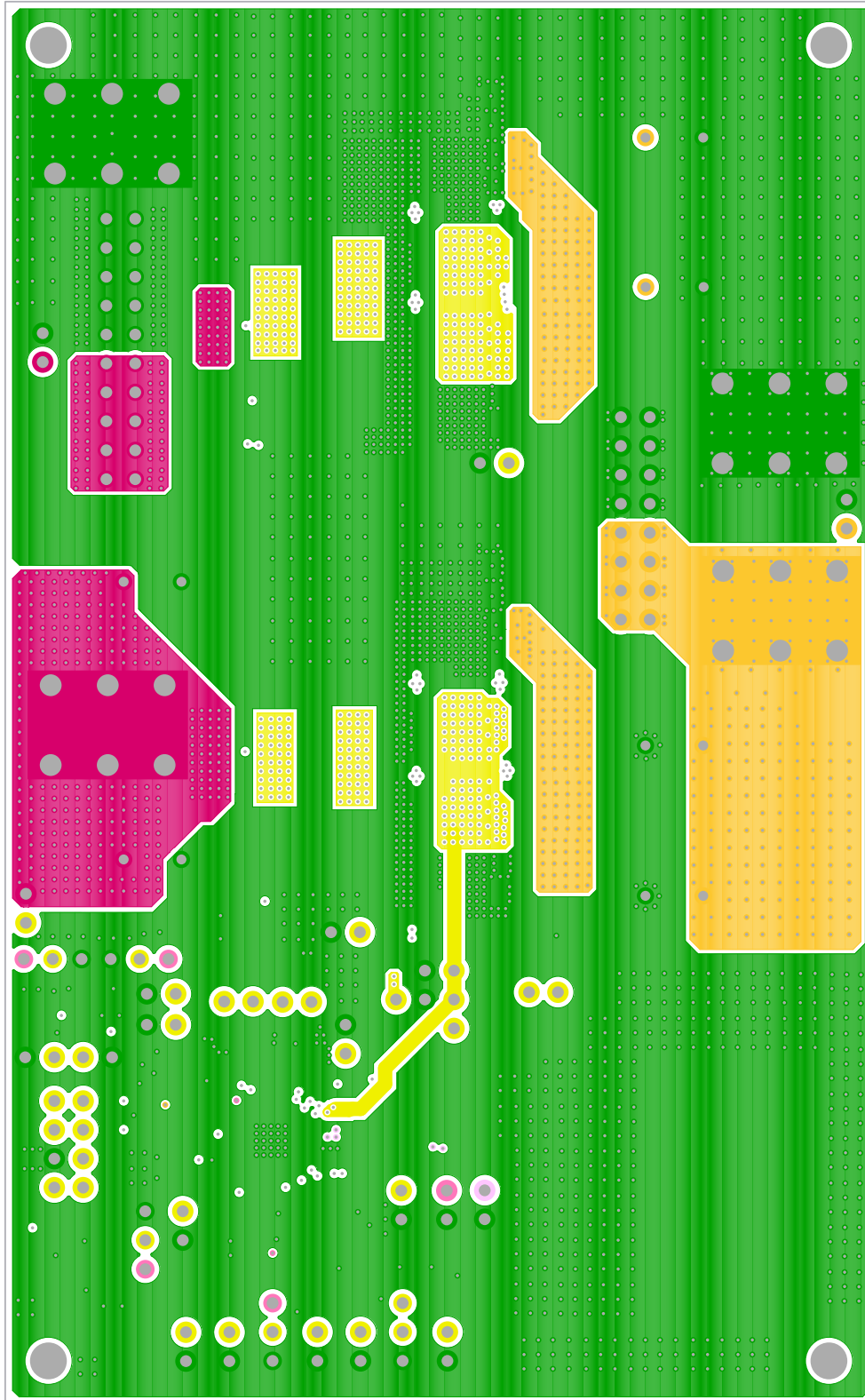

FIGURE 15. 4th LAYER

Board Layout (Continued)

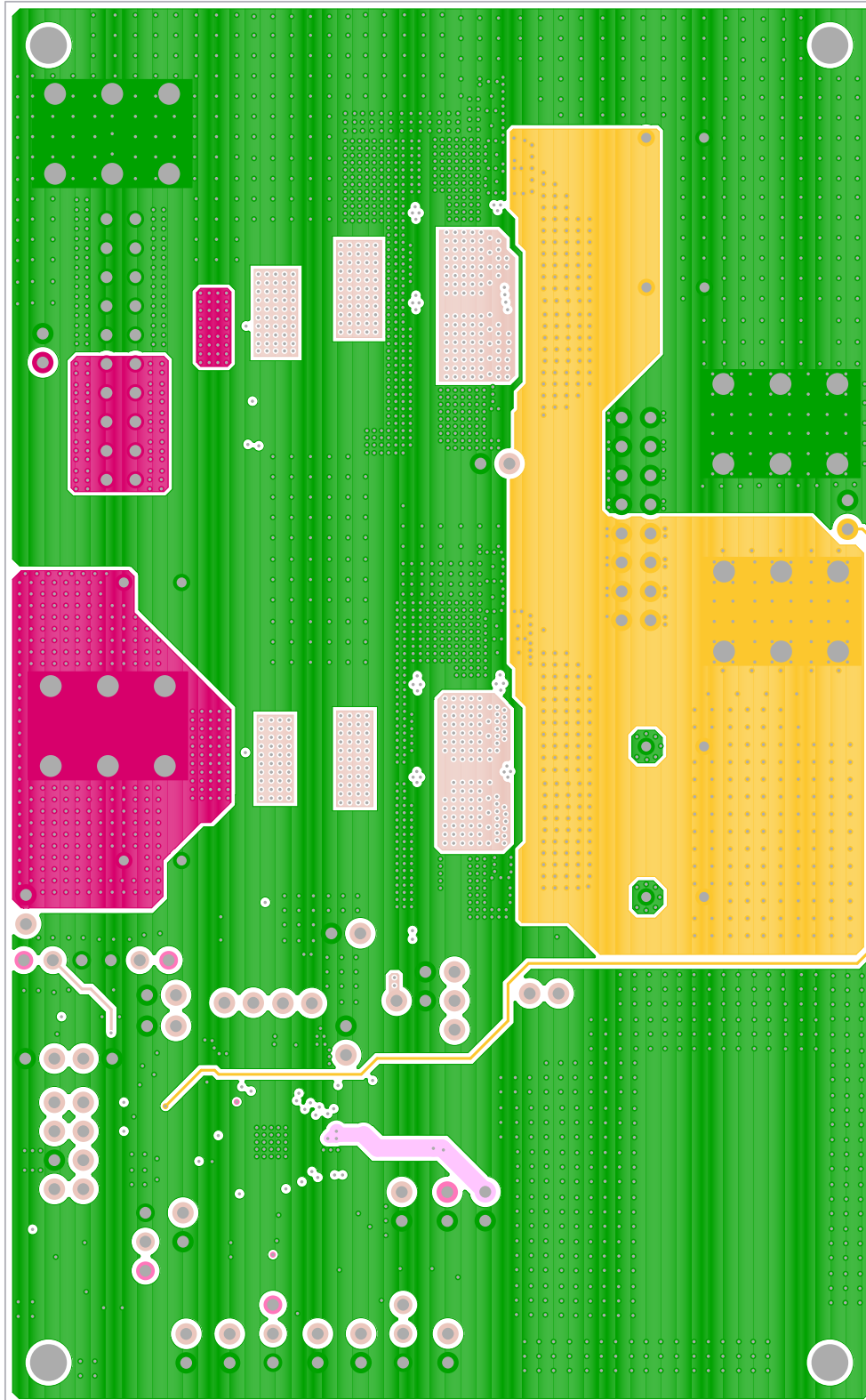

FIGURE 16. 5th LAYER

Board Layout (Continued)

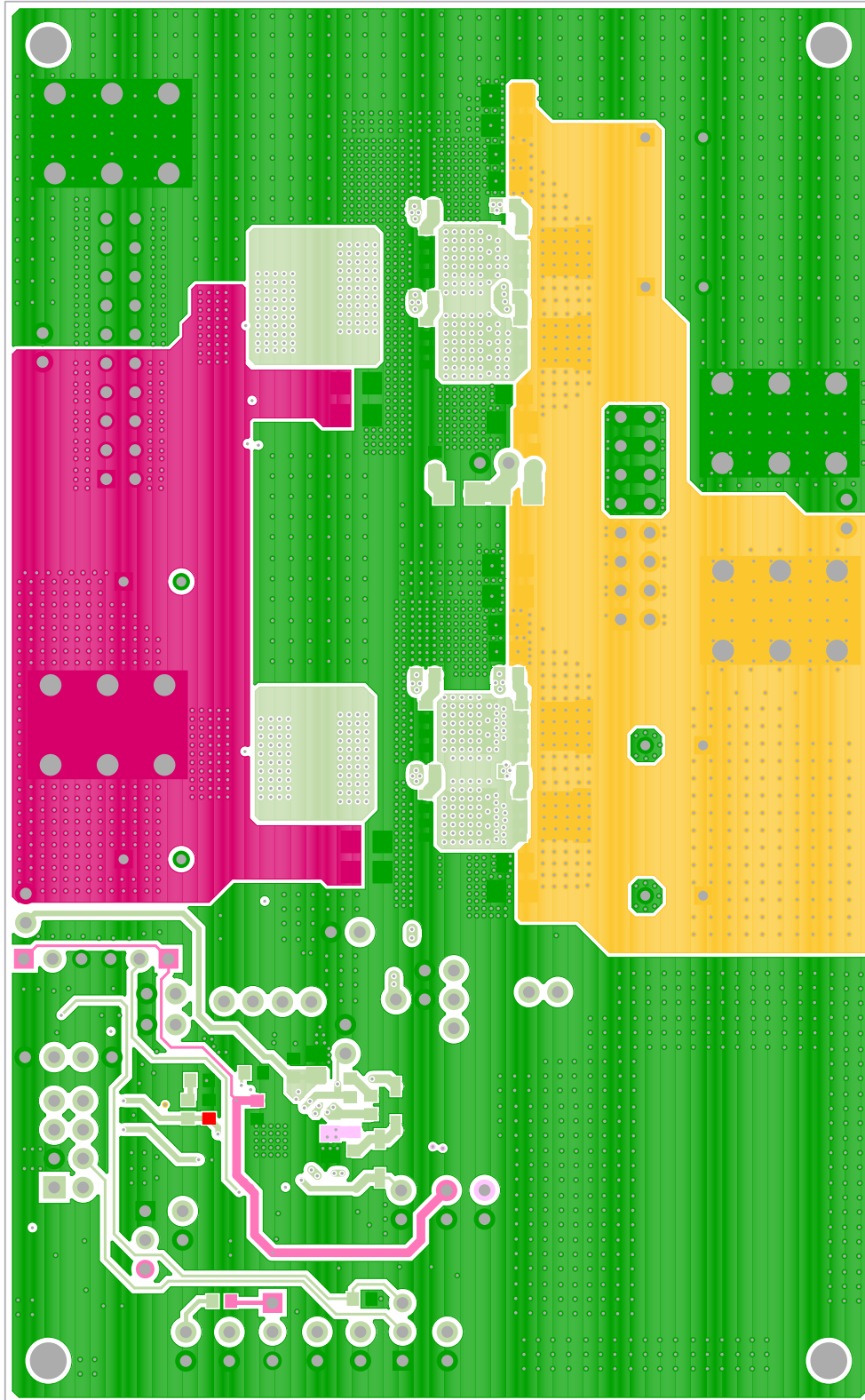

FIGURE 17. BOTTOM LAYER

Board Layout (Continued)

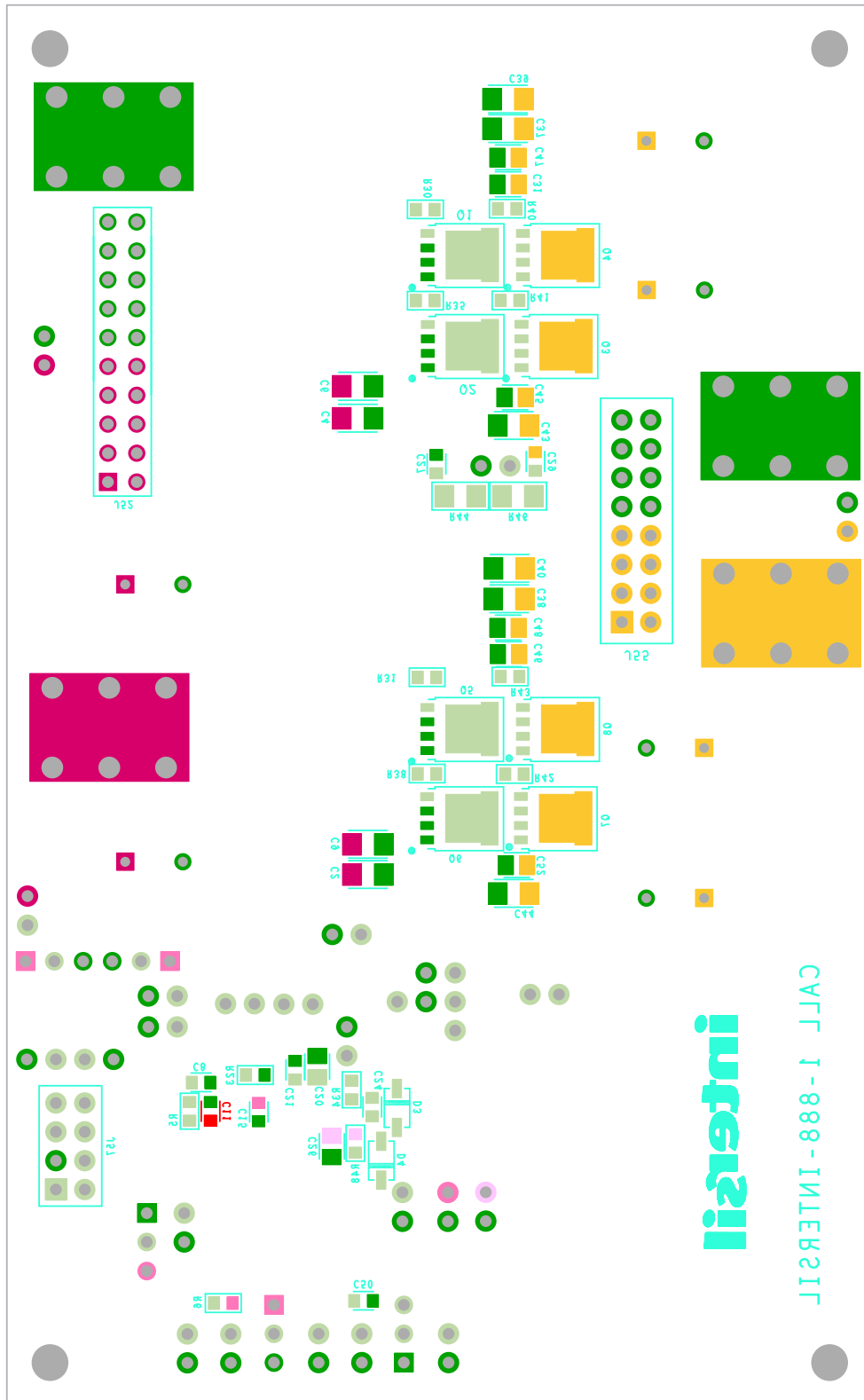

FIGURE 18. BOTTOM SILKSREEN AND PIN PADS

Board Layout (Continued)

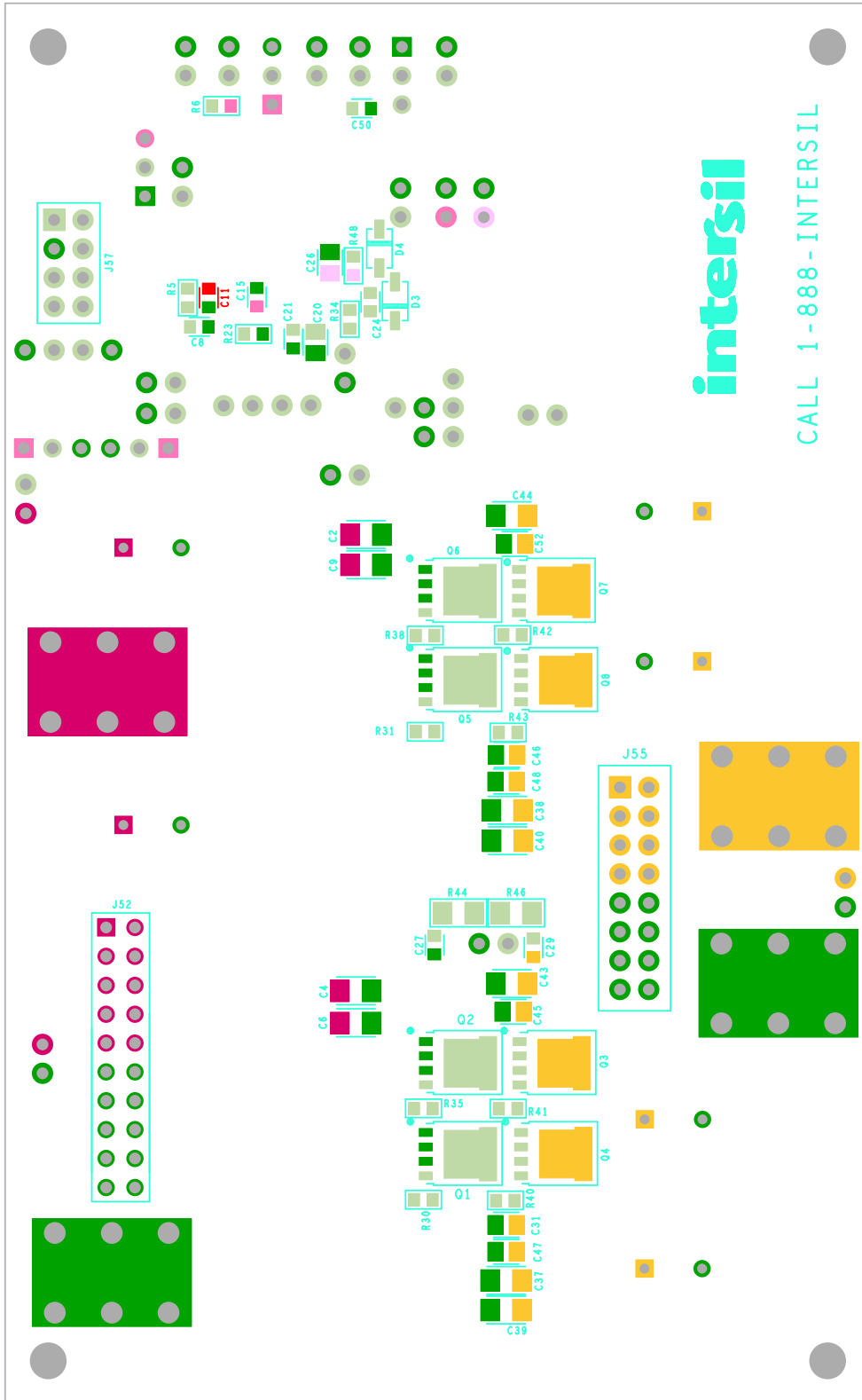
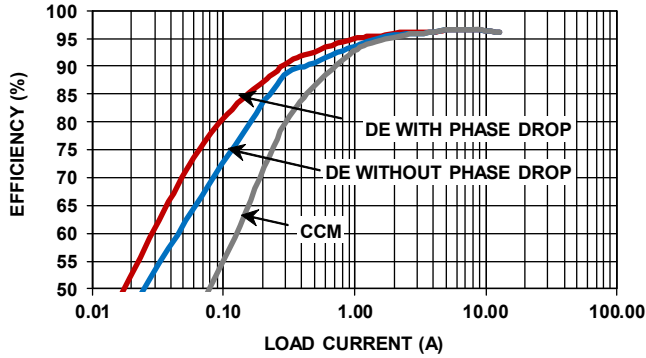

FIGURE 19. BOTTOM SILKSREEN AND PIN PADS (MIRRORED)

Performance Curves

Unless otherwise specified, operating conditions for the oscilloscope waveforms are $V_{IN} = 12V$, $V_{OUT} = 36V$ and $T_A = +25^\circ C$.



NOTE: (See Typical Application in Figure 4 in the [ISL78227](#) datasheet.)

FIGURE 20. EFFICIENCY vs LOAD, 2-PHASE BOOST, 3 MODES OPERATION, $f_{SW} = 200kHz$, $V_{IN} = 12V$, $V_{OUT} = 36V$, $T_A = +25^\circ C$

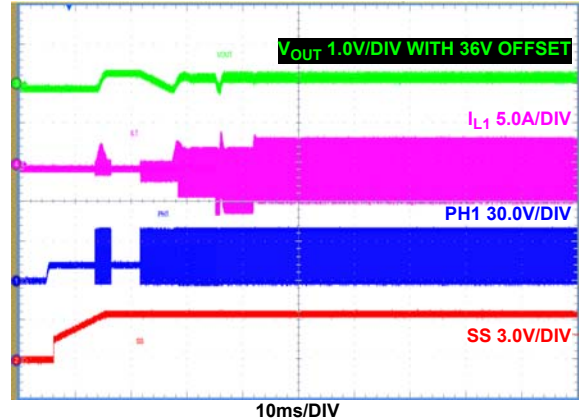

FIGURE 21. EN INTO PREBIASED OUTPUT, CCM MODE (DE/PHDRP = GND), $I_{OUT} = 0A$

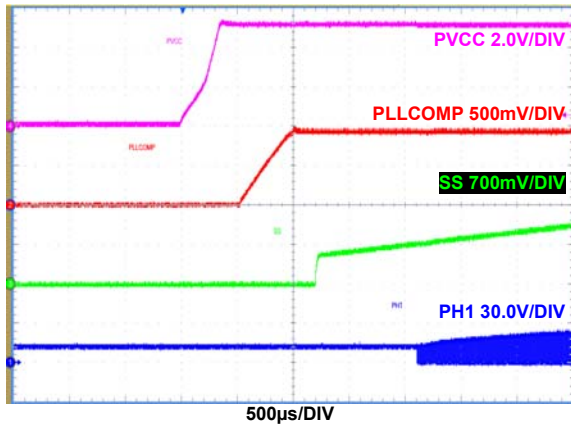

FIGURE 22. EN ON AND INITIALIZATION TO START-UP, $I_{OUT} = 0A$

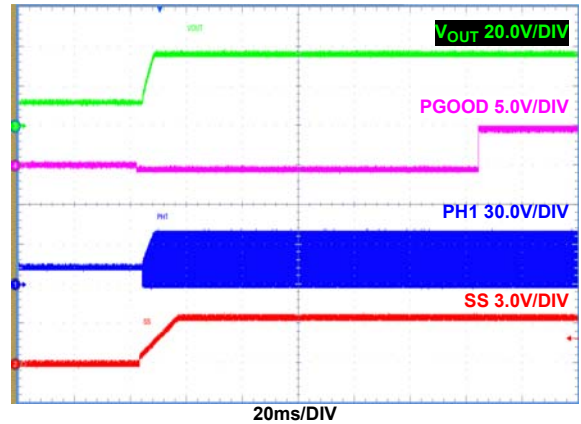

FIGURE 23. SOFT-START, CCM MODE (DE/PHDRP = GND), $I_{OUT} = 8A$

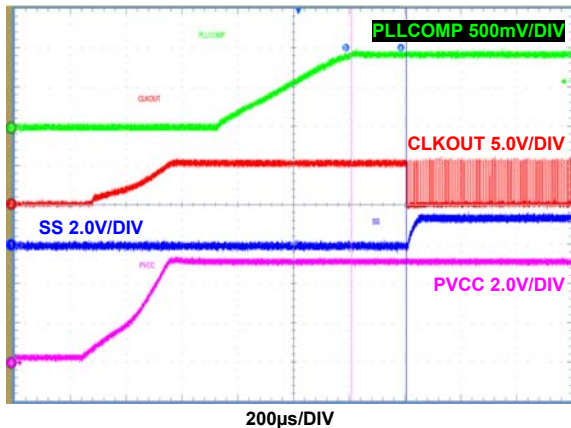

FIGURE 24. EN ON AND INITIALIZATION TO START-UP, $I_{OUT} = 0A$

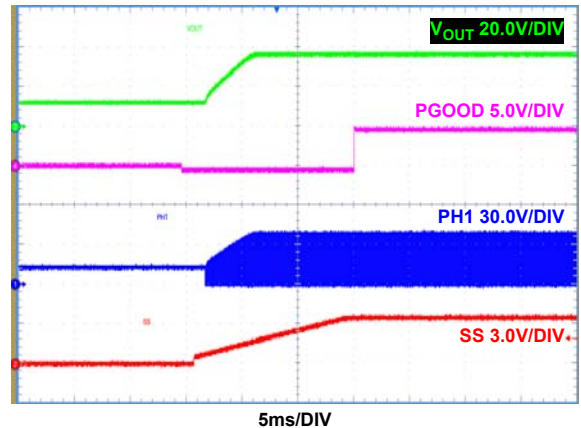

FIGURE 25. SOFT-START, DE+PHDRP MODE (DE/PHDRP = FLOAT), $I_{OUT} = 8A$

Performance Curves

Unless otherwise specified, operating conditions for the oscilloscope waveforms are $V_{IN} = 12V$, $V_{OUT} = 36V$ and $T_A = +25^\circ C$. (Continued)

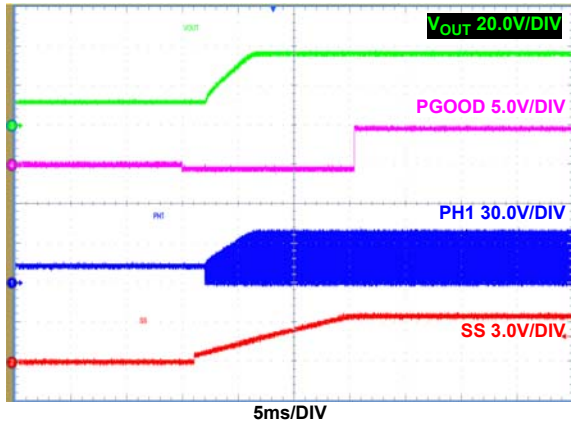

FIGURE 26. SOFT-START, DE MODE (DE/PHDRP = VCC), $I_{OUT} = 8A$

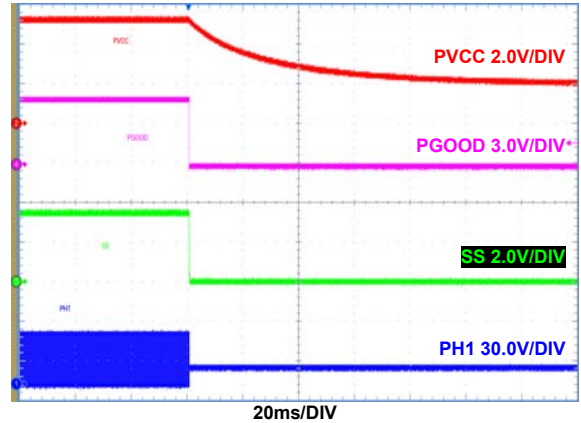

FIGURE 27. EN SHUTDOWN, PVCC/PGOOD/SS FALL, $I_{OUT} = 0A$

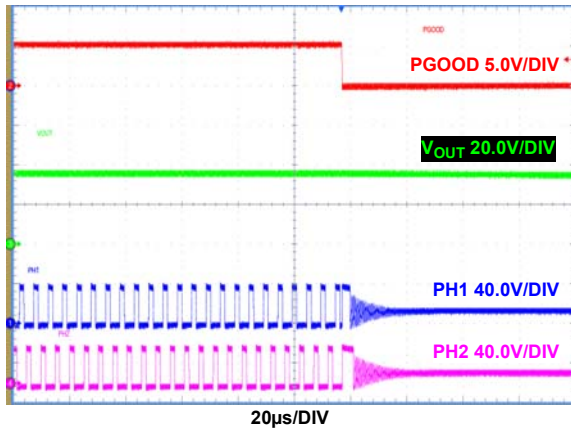

FIGURE 28. EN SHUTDOWN, $I_{OUT} = 8A$

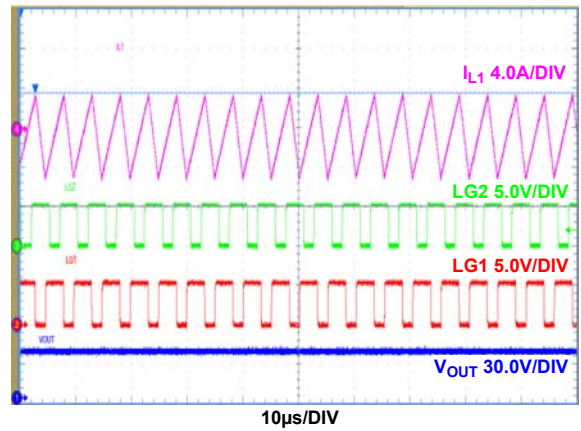

FIGURE 29. CCM MODE (DE/PHDRP = GND), PHASE 1 INDUCTOR RIPPLE CURRENT, $I_{OUT} = 0A$

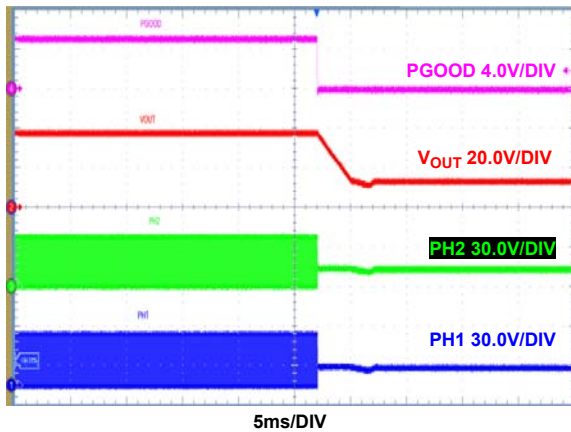

FIGURE 30. EN SHUTDOWN, $I_{OUT} = 8A$

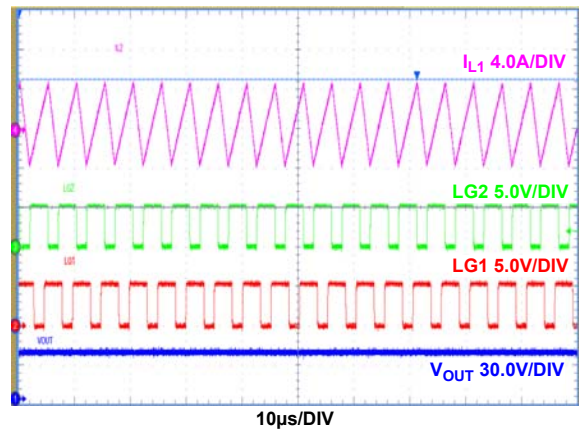

FIGURE 31. CCM MODE (DE/PHDRP = GND), PHASE 1 INDUCTOR RIPPLE CURRENT, $I_{OUT} = 0A$

Performance Curves

Unless otherwise specified, operating conditions for the oscilloscope waveforms are $V_{IN} = 12V$, $V_{OUT} = 36V$ and $T_A = +25^\circ C$. (Continued)

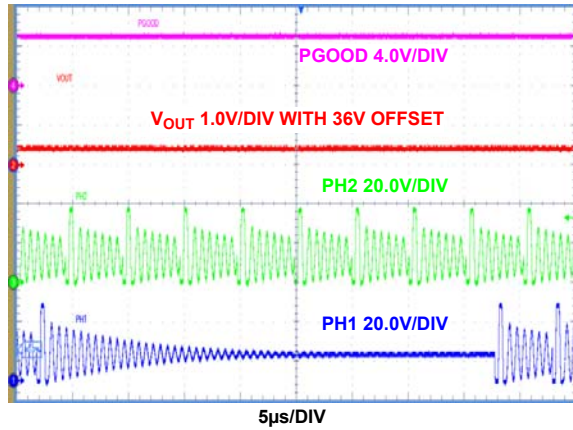

FIGURE 32. DE MODE (DE/PHDRP = VCC), DIODE EMULATION OPERATION, PULSE SKIPPING, $I_{OUT} = 0A$

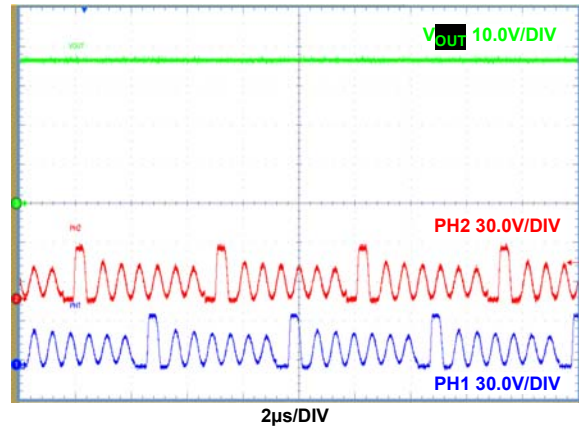

FIGURE 33. DE MODE (DE/PHDRP = VCC), DIODE EMULATION OPERATION, $I_{OUT} = 29mA$

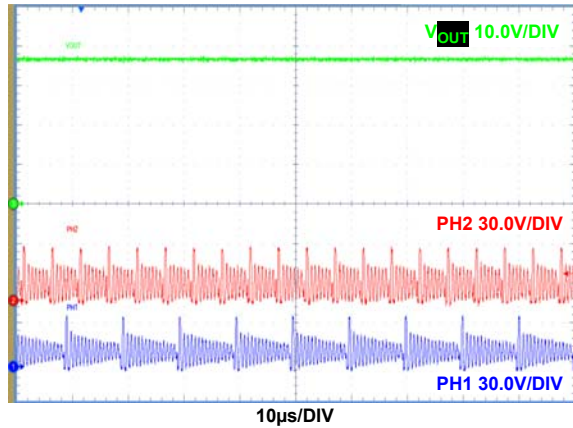

FIGURE 34. DE MODE (DE/PHDRP = VCC), PH1 AND PH2 DIODE EMULATION OPERATION, PULSE SKIPPING, $I_{OUT} = 7mA$

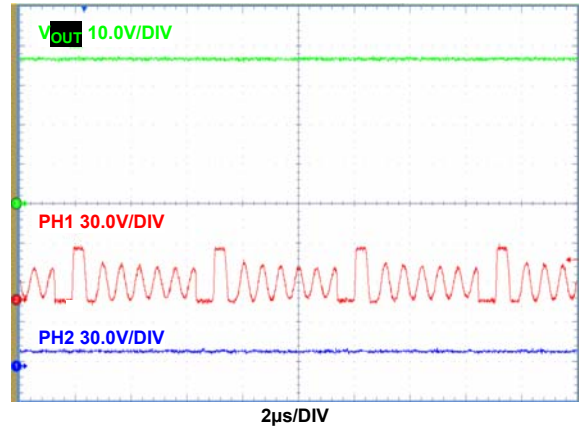

FIGURE 35. DE+PH_DROP MODE (DE/PHDRP = FLOAT), PH1 DIODE EMULATION WITH PH2 DROPPED, $I_{OUT} = 29mA$

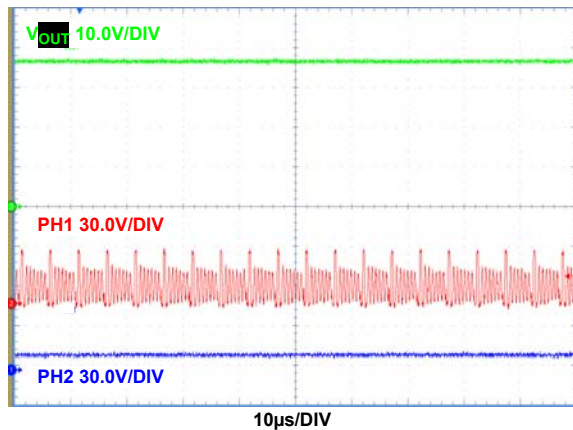

FIGURE 36. DE+PHDRP MODE (DE/PHDRP = FLOAT), PH1 DIODE EMULATION WITH PH2 DROPPED, $I_{OUT} = 7mA$

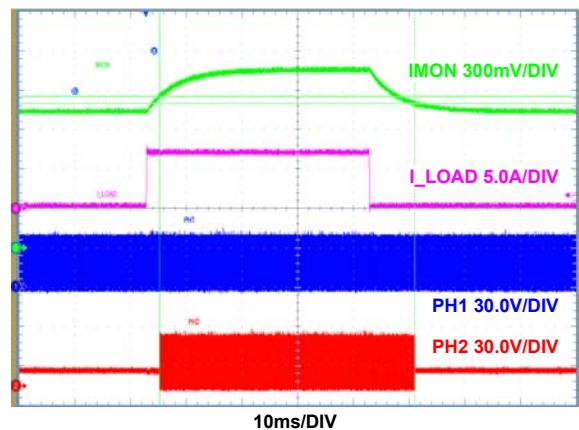

FIGURE 37. DE+PHDRP MODE (DE/PHDRP = FLOAT), PH2 ADDED AND DROPPED, UNDER TRANSIENT STEP LOAD OF 1A TO 8A

Performance Curves

Unless otherwise specified, operating conditions for the oscilloscope waveforms are $V_{IN} = 12V$, $V_{OUT} = 36V$ and $T_A = +25^\circ C$. (Continued)

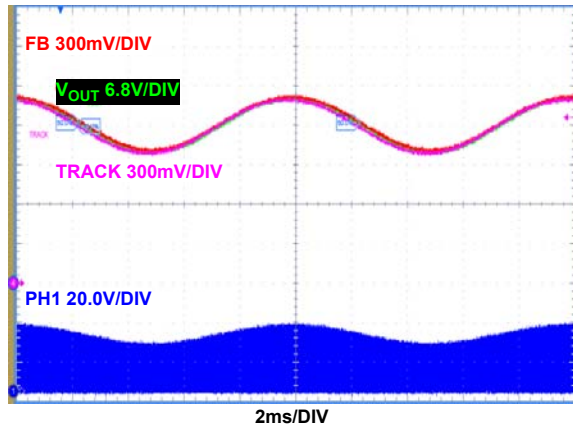

FIGURE 38. ANALOG TRACKING 100Hz SINUSOIDAL SIGNAL, CCM MODE (DE/PHDRP = GND), ATRK/DTRAK = VCC, $I_{OUT} = 1A$

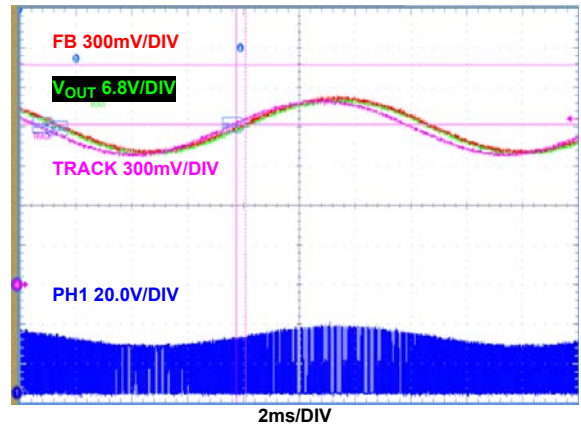

FIGURE 39. ANALOG TRACKING 300Hz SINUSOIDAL SIGNAL AT THE TRACK PIN, CCM MODE (DE/PHDRP = GND), ATRK/DTRAK = VCC, $I_{OUT} = 1A$

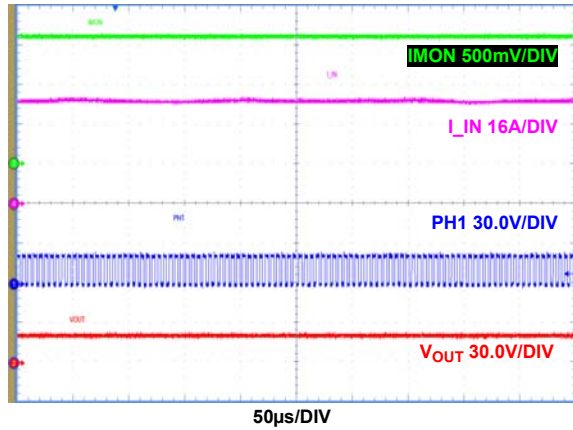

FIGURE 40. STEADY-STATE OPERATION OF INPUT CONSTANT CURRENT MODE, I_{IN} CONTROLLED AT 43A CONSTANT, $V_{OUT} = 19.5V$

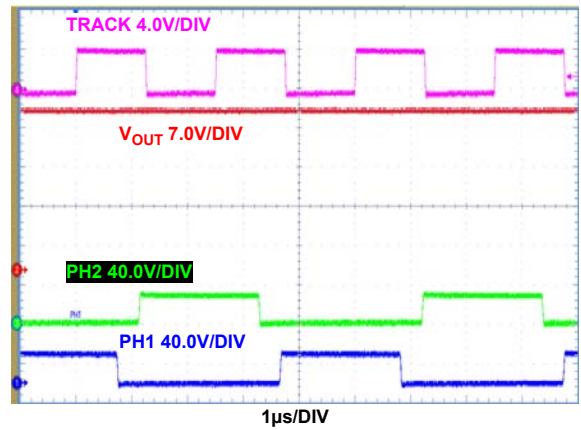

FIGURE 41. DIGITAL TRACKING (TRACKING SIGNAL, FREQUENCY = 400kHz, D = 0.5, $V_{OUT} = 28.3V$)

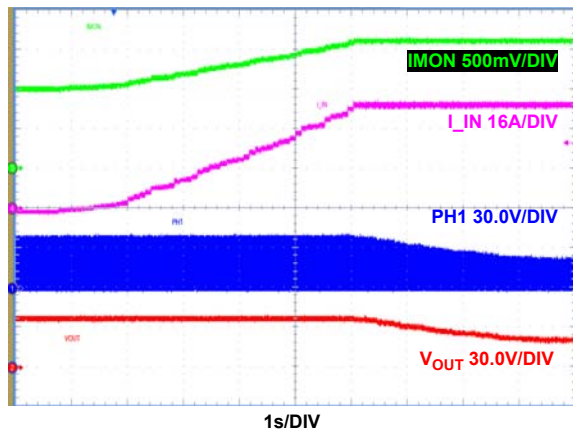

FIGURE 42. LOAD CURRENT KEEP INCREASING FROM NO LOAD TO OVERLOAD (25A), V_{OUT} STARTS TO DROP WHEN INPUT CONSTANT CURRENT MODE STARTS TO WORK, INPUT CURRENT IS FINALLY CONTROLLED TO BE CONSTANT

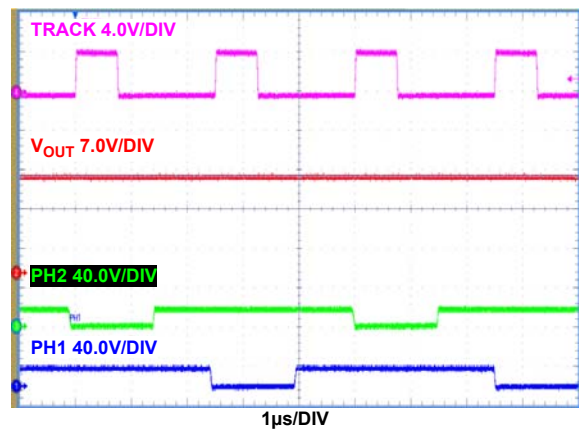

FIGURE 43. DIGITAL TRACKING (TRACKING SIGNAL, FREQUENCY = 400kHz, D = 0.3, $V_{OUT} = 17V$)

Performance Curves

Unless otherwise specified, operating conditions for the oscilloscope waveforms are $V_{IN} = 12V$, $V_{OUT} = 36V$ and $T_A = +25^\circ C$. (Continued)

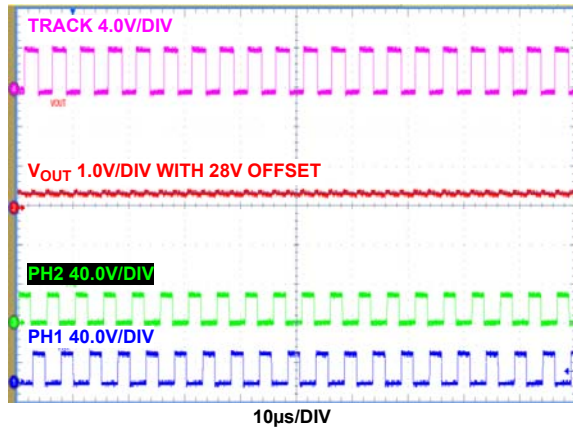

FIGURE 44. DIGITAL TRACKING, (TRACKING SIGNAL, FREQUENCY = 200kHz, D = 0.5), $V_{OUT} = 28.3V$

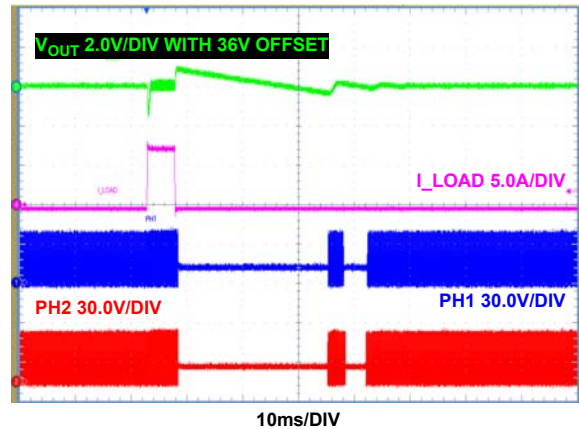

FIGURE 45. DE MODE (DE/PHDRP = VCC), TRANSIENT RESPONSE, $I_{OUT} = 0.03$ TO 8A STEP LOAD

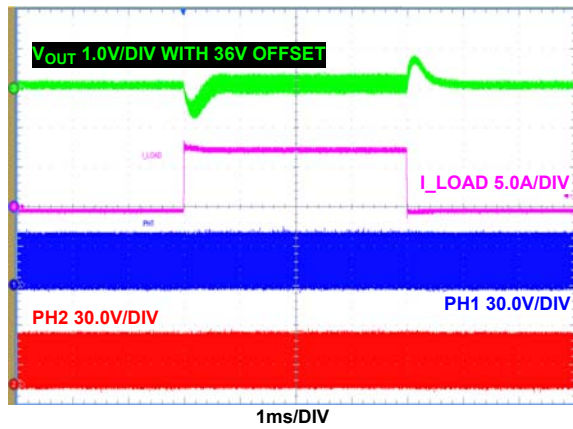

FIGURE 46. CCM MODE (DE/PHDRP = GND), TRANSIENT RESPONSE, $I_{OUT} = 0$ TO 8A STEP LOAD

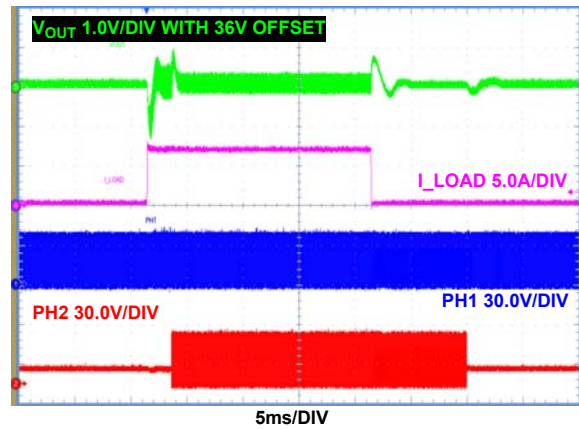

FIGURE 47. DE+PH_DROP MODE (DE/PHDRP = FLOAT), TRANSIENT RESPONSE, $I_{OUT} = 1$ TO 8A STEP LOAD

Notice

1. Descriptions of circuits, software and other related information in this document are provided only to illustrate the operation of semiconductor products and application examples. You are fully responsible for the incorporation or any other use of the circuits, software, and information in the design of your product or system. Renesas Electronics disclaims any and all liability for any losses and damages incurred by you or third parties arising from the use of these circuits, software, or information.
2. Renesas Electronics hereby expressly disclaims any warranties against and liability for infringement or any other claims involving patents, copyrights, or other intellectual property rights of third parties, by or arising from the use of Renesas Electronics products or technical information described in this document, including but not limited to, the product data, drawings, charts, programs, algorithms, and application examples.
3. No license, express, implied or otherwise, is granted hereby under any patents, copyrights or other intellectual property rights of Renesas Electronics or others.
4. You shall not alter, modify, copy, or reverse engineer any Renesas Electronics product, whether in whole or in part. Renesas Electronics disclaims any and all liability for any losses or damages incurred by you or third parties arising from such alteration, modification, copying or reverse engineering.
5. Renesas Electronics products are classified according to the following two quality grades: "Standard" and "High Quality". The intended applications for each Renesas Electronics product depends on the product's quality grade, as indicated below.
"Standard": Computers; office equipment; communications equipment; test and measurement equipment; audio and visual equipment; home electronic appliances; machine tools; personal electronic equipment; industrial robots; etc.
"High Quality": Transportation equipment (automobiles, trains, ships, etc.); traffic control (traffic lights); large-scale communication equipment; key financial terminal systems; safety control equipment; etc.
Unless expressly designated as a high reliability product or a product for harsh environments in a Renesas Electronics data sheet or other Renesas Electronics document, Renesas Electronics products are not intended or authorized for use in products or systems that may pose a direct threat to human life or bodily injury (artificial life support devices or systems; surgical implantations; etc.), or may cause serious property damage (space system; undersea repeaters; nuclear power control systems; aircraft control systems; key plant systems; military equipment; etc.). Renesas Electronics disclaims any and all liability for any damages or losses incurred by you or any third parties arising from the use of any Renesas Electronics product that is inconsistent with any Renesas Electronics data sheet, user's manual or other Renesas Electronics document.
6. When using Renesas Electronics products, refer to the latest product information (data sheets, user's manuals, application notes, "General Notes for Handling and Using Semiconductor Devices" in the reliability handbook, etc.), and ensure that usage conditions are within the ranges specified by Renesas Electronics with respect to maximum ratings, operating power supply voltage range, heat dissipation characteristics, installation, etc. Renesas Electronics disclaims any and all liability for any malfunctions, failure or accident arising out of the use of Renesas Electronics products outside of such specified ranges.
7. Although Renesas Electronics endeavors to improve the quality and reliability of Renesas Electronics products, semiconductor products have specific characteristics, such as the occurrence of failure at a certain rate and malfunctions under certain use conditions. Unless designated as a high reliability product or a product for harsh environments in a Renesas Electronics data sheet or other Renesas Electronics document, Renesas Electronics products are not subject to radiation resistance design. You are responsible for implementing safety measures to guard against the possibility of bodily injury, injury or damage caused by fire, and/or danger to the public in the event of a failure or malfunction of Renesas Electronics products, such as safety design for hardware and software, including but not limited to redundancy, fire control and malfunction prevention, appropriate treatment for aging degradation or any other appropriate measures. Because the evaluation of microcomputer software alone is very difficult and impractical, you are responsible for evaluating the safety of the final products or systems manufactured by you.
8. Please contact a Renesas Electronics sales office for details as to environmental matters such as the environmental compatibility of each Renesas Electronics product. You are responsible for carefully and sufficiently investigating applicable laws and regulations that regulate the inclusion or use of controlled substances, including without limitation, the EU RoHS Directive, and using Renesas Electronics products in compliance with all these applicable laws and regulations. Renesas Electronics disclaims any and all liability for damages or losses occurring as a result of your noncompliance with applicable laws and regulations.
9. Renesas Electronics products and technologies shall not be used for or incorporated into any products or systems whose manufacture, use, or sale is prohibited under any applicable domestic or foreign laws or regulations. You shall comply with any applicable export control laws and regulations promulgated and administered by the governments of any countries asserting jurisdiction over the parties or transactions.
10. It is the responsibility of the buyer or distributor of Renesas Electronics products, or any other party who distributes, disposes of, or otherwise sells or transfers the product to a third party, to notify such third party in advance of the contents and conditions set forth in this document.
11. This document shall not be reprinted, reproduced or duplicated in any form, in whole or in part, without prior written consent of Renesas Electronics.
12. Please contact a Renesas Electronics sales office if you have any questions regarding the information contained in this document or Renesas Electronics products.
(Note 1) "Renesas Electronics" as used in this document means Renesas Electronics Corporation and also includes its directly or indirectly controlled subsidiaries.
(Note 2) "Renesas Electronics product(s)" means any product developed or manufactured by or for Renesas Electronics.

(Rev.4.0-1 November 2017)



SALES OFFICES

Renesas Electronics Corporation

<http://www.renesas.com>

Refer to "<http://www.renesas.com/>" for the latest and detailed information.

Renesas Electronics America Inc.
1001 Murphy Ranch Road, Milpitas, CA 95035, U.S.A.
Tel: +1-408-432-8888, Fax: +1-408-434-5351

Renesas Electronics Canada Limited
9251 Yonge Street, Suite 8309 Richmond Hill, Ontario Canada L4C 9T3
Tel: +1-905-237-2004

Renesas Electronics Europe Limited
Dukes Meadow, Millboard Road, Bourne End, Buckinghamshire, SL8 5FH, U.K
Tel: +44-1628-651-700, Fax: +44-1628-651-804

Renesas Electronics Europe GmbH
Arcadiastrasse 10, 40472 Düsseldorf, Germany
Tel: +49-211-6503-0, Fax: +49-211-6503-1327

Renesas Electronics (China) Co., Ltd.
Room 1709 Quantum Plaza, No.27 ZhichunLu, Haidian District, Beijing, 100191 P. R. China
Tel: +86-10-8235-1155, Fax: +86-10-8235-7679

Renesas Electronics (Shanghai) Co., Ltd.
Unit 301, Tower A, Central Towers, 555 Langao Road, Putuo District, Shanghai, 200333 P. R. China
Tel: +86-21-2226-0888, Fax: +86-21-2226-0999

Renesas Electronics Hong Kong Limited
Unit 1601-1611, 16/F., Tower 2, Grand Century Place, 193 Prince Edward Road West, Mongkok, Kowloon, Hong Kong
Tel: +852-2265-6688, Fax: +852-2886-9022

Renesas Electronics Taiwan Co., Ltd.
13F, No. 363, Fu Shing North Road, Taipei 10543, Taiwan
Tel: +886-2-8175-9600, Fax: +886-2-8175-9670

Renesas Electronics Singapore Pte. Ltd.
80 Bendemeer Road, Unit #06-02 Hyflux Innovation Centre, Singapore 339949
Tel: +65-6213-0200, Fax: +65-6213-0300

Renesas Electronics Malaysia Sdn.Bhd.
Unit 1207, Block B, Menara Amcorp, Amcorp Trade Centre, No. 18, Jln Persiaran Barat, 46050 Petaling Jaya, Selangor Darul Ehsan, Malaysia
Tel: +60-3-7955-9390, Fax: +60-3-7955-9510

Renesas Electronics India Pvt. Ltd.
No.777C, 100 Feet Road, HAL 2nd Stage, Indiranagar, Bangalore 560 038, India
Tel: +91-80-67208700, Fax: +91-80-67208777

Renesas Electronics Korea Co., Ltd.
17F, KAMCO Yangjae Tower, 262, Gangnam-daero, Gangnam-gu, Seoul, 06265 Korea
Tel: +82-2-558-3737, Fax: +82-2-558-5338