

ISL78268EVAL1Z

Evaluation Board User

AN1946
Rev 0.00
July 7, 2014

Introduction

ISL78268 is an automotive grade synchronous buck controller with the 2-A sourcing/3-A sinking Integrated MOSFET Drivers. The device supports the wide input supply voltage range of 5V to 55V for full operation and protected up to 60V when not switching. The ISL78268EVAL1Z is a fully configured buck converter evaluation board with ISL78268, MOSFETS, an inductor, current sense resistors and other necessary components. The evaluation board has been designed to quickly evaluate the various features and performance of the ISL78268.

Specification (Default Setting)

- $V_{IN} = 14V$ to $55V$
- $V_{OUT} = 12V$
- V_{IN} overvoltage protection = $58V$ (rising threshold to trigger hiccup or latch-off)
- Output overcurrent limit 1 (OC1: cycle-by-cycle) = $9.3A$
- Output overcurrent limit 2 (OC2: hiccup/latch-off) = $12.4A$
- Output average constant current limit = $4.05A$ (if activated)
- Switching frequency = $300kHz$
- Peak efficiency > 95% ($V_{IN} = 15V / I_{OUT} = 4A$)

Key Features

- Wide operational input voltage range up to $55V$ (switching), withstand $60V$ (non-switching)
- Average output constant current limiting
- Selectable diode emulation mode or forced PWM mode
- Selectable switching clock source: internal or external
- Low shutdown current: $I_Q < 10\mu A$
- Selectable latch-off or hiccup mode fault response
- Comprehensive fault protections:
 - Input and output overvoltage protection
 - Cycle-by-cycle overcurrent limit (OC1) and protection (OC2)
 - Average current overcurrent protection
 - Over-temperature protection
- Monitor test points for key signals

Reference

- [ISL78268 Datasheet](#)

Ordering Information

PART NUMBER	DESCRIPTION
ISL78268EVAL1Z	ISL78268 Evaluation Board

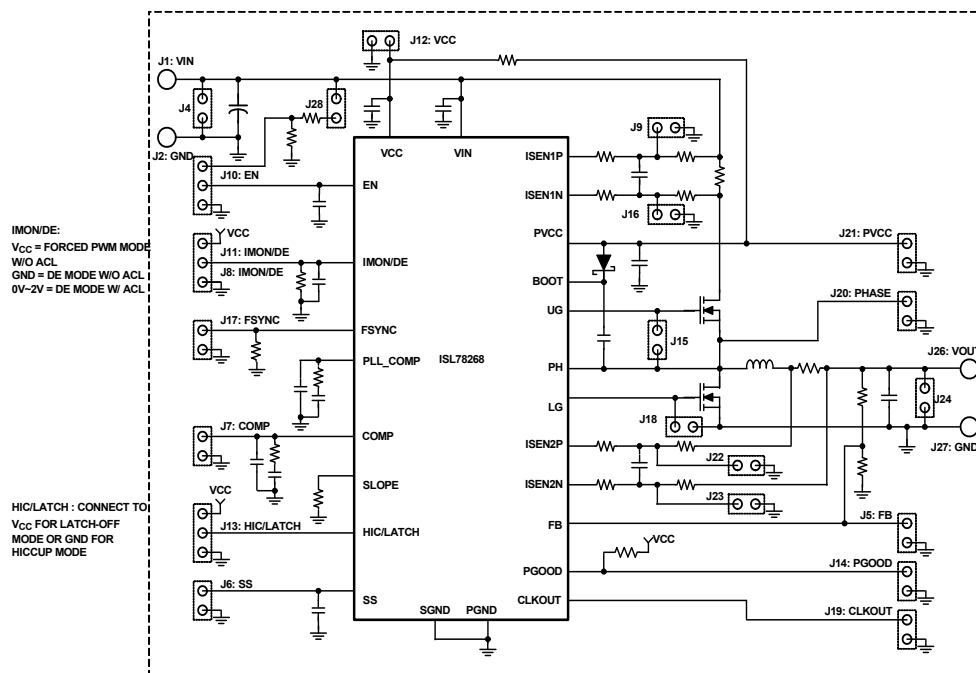

FIGURE 1. ISL78268EVAL1Z BLOCK DIAGRAM

Functional Description

The ISL78268 is a high voltage synchronous buck controller with integrated 2A source/3A sink MOSFET drivers. The device operates over a wide input voltage range, 5V to 55V, and withstands up to 60V. The full synchronous operation of ISL78268 enables high conversion efficiency in continuous conduction mode. Also, the device provides Diode Emulation mode (DE mode) for efficiency improvement in light load operation. The ISL78268 also provides comprehensive protection features of input and output overvoltage, cycle-by-cycle peak current limiting, average output current limiting and thermal protection.

The ISL78268EVAL1Z evaluation board is shown in [Figures 2](#) and [3](#). The board supports quick evaluation of various features of the ISL78268. The ISL78268EVAL1Z's default configuration is for 12V at VOUT, with a peak current limit (OC1: cycle-by-cycle) of 9.3A, peak current protection (OC2: hiccup/ latch-off) 12.4A, and an average current limit of 4A.

The operation mode of DE mode or Forced PWM mode is selectable by the connection of IMON/DE pins. The fault response of hiccup or latch-off is selected by the connection of HIC/LATCH pin. Voltage or waveforms of key signals such as VCC, SS, FB, COMP, EN, CLKOUT, PH etc., are pulled out to the monitor pins for easy measurement. [Table 1](#) shows more details of connector/monitor-pin descriptions.

[Figure 4](#) shows the schematics of this evaluation board and [Table 3](#) shows its BOM list. The layout information of the board are shown in [Figures 5](#) through [10](#).

[Figures 11](#) through [24](#) show the performance data taken with this evaluation board with default configuration.

Operating Range

The default configuration is shown in "[Specification \(Default Setting\)](#)" on [page 1](#).

The board setting can be changed by changing the connections of setting pins or replacing the resistors and/or capacitors populated on the board. Some examples are described as follows:

- The switching frequency on the ISL78268EVAL1Z is fixed at 300kHz. To change the frequency, replace the R₁₈ which is connected between FSYNC and GND. Please refer to the "Internal Clock Frequency Setting" section in Datasheet for detail. Also, the clock can be synchronized with the external clock source by input square wave at FSYNC pin. The external clock frequency range will be 50kHz to 1.1MHz.
- The output voltage of ISL78268EVAL1Z is fixed at 12V in default setting. This can be changed by replacing feedback resistor R₁. When changing the feedback resistor, the minimum input voltage on the board will be changed accordingly. If changing the output voltage, be careful because the minimum input voltage will be limited by the high-side MOSFET minimum off time (t_{MINOFF_UG}) of the ISL78268, which is 285ns (typ). Also, the maximum input voltage will be limited by the minimum on time of high-side MOSFET (t_{MINON_UG}) which is 300ns (typ).
- The operation mode of DE mode or Forced PWM mode is selectable by the connection of IMON/DE pins.
- The fault response of hiccup or latch-off is selected by the connection of HIC/LATCH pin.
- The average output current limit can be adjusted by replacing the resistor connected to IMON/DE pin (R₄). For the setting of the average current limit, please refer to "Current Sensing" and "Average Constant Current Control" sections in the [ISL78268](#) datasheet.
- The cycle-by-cycle peak current limit can be changed by replacing the current sense resistor (R₁₀) and/or gain set resistor (R₈+R₉). Please refer to "Current Sensing" and "Cycle-by-Cycle Peak Overcurrent Limiting/Protection" sections in [ISL78268](#) datasheet for the detailed relation between R₁₀ and/or R₈+R₉ and peak current limit.

PCB Layout Guideline

The ISL78268EVAL1Z layout is optimized for electrical and thermal performances. Key considerations are:

- Most of switching nodes are patterned on the top layer with simple and short routing.
- 4x4 pattern of 300µm vias under the ISL78268 thermal pad are connected to large copper GND planes (layers 2, 3 and 4) for effective thermal performances.
- Maximize the copper layers of the Power Transistor Drain node by connecting each layers with multiple via for the effective thermal performances.
- Place the input ceramic capacitor as close as possible to the VIN pin.
- Place the ceramic capacitor as close as possible to minimize the ringing associated by the parasitic inductance and capacitance in the high current transition loop.
- Keep the traces of current sense lines symmetric as much as possible to avoid the offset and noise injection.
- The board size is 2.65 in. x 2.85 in. with 4-layers and 2oz copper.

ISL78268EVAL1Z Evaluation Board

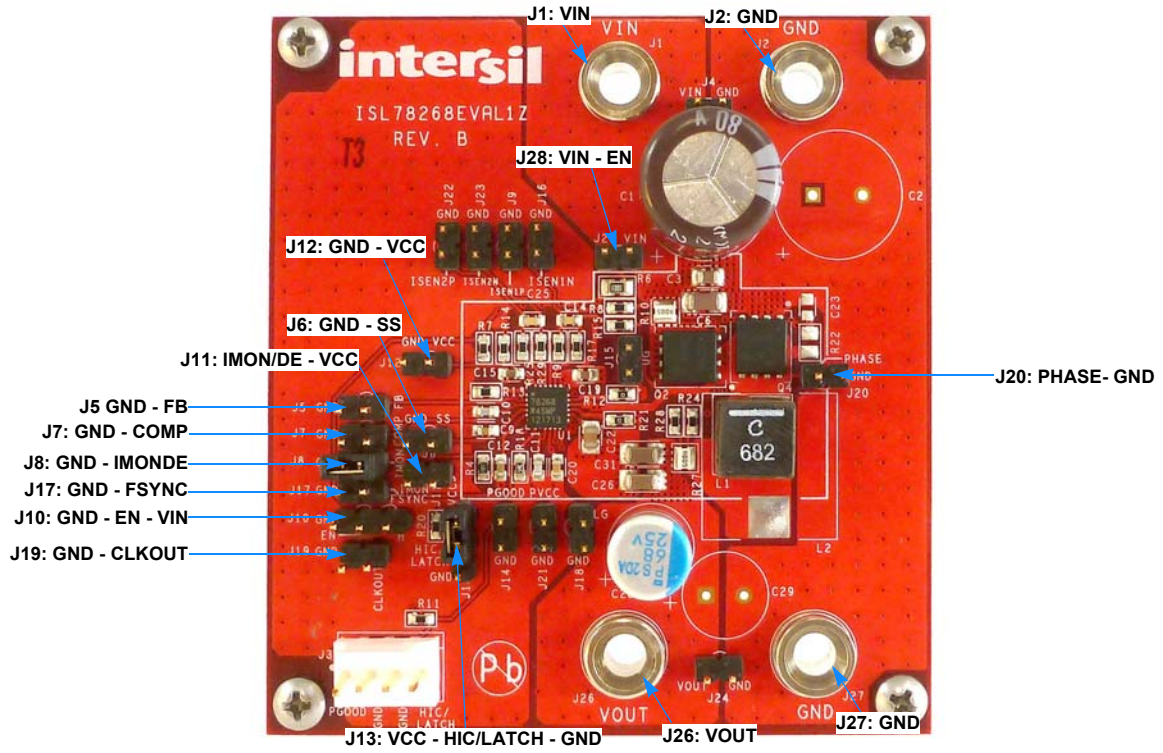

FIGURE 2. TOP VIEW

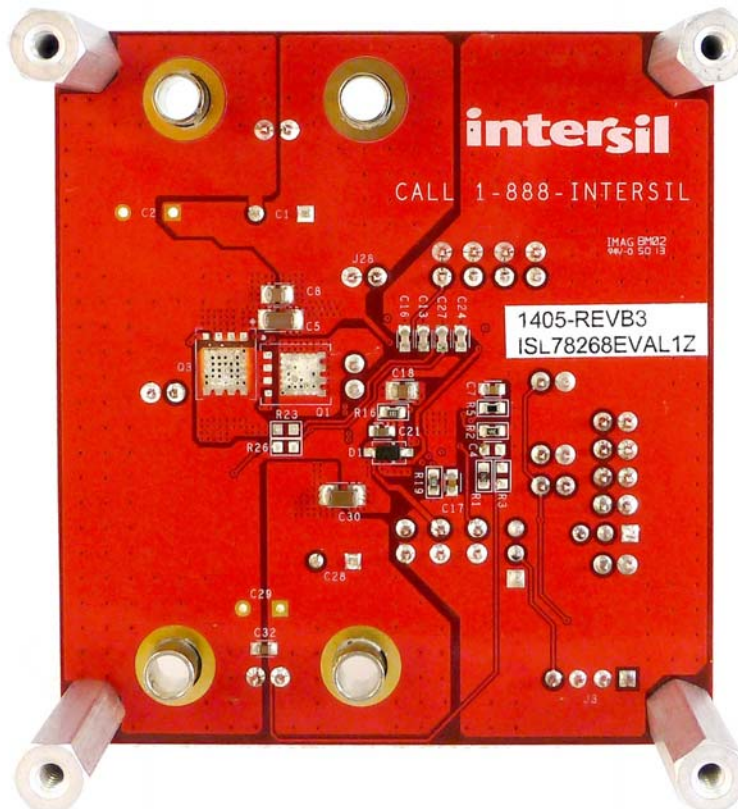

FIGURE 3. BOTTOM VIEW

Connector/Monitor-pin Description

Table 1 shows the jumper/terminal configuration of the ISL78268EVAL1Z.

TABLE 1. ISL78268EV1ZB CONNECTOR/MONITOR-PIN DESCRIPTION

CONNECTOR/ TERMINAL	SIGNAL NAME	DESCRIPTIONS									
J1	VIN	Positive input terminal of the system.									
J2	GND	Negative input terminal of the system (ground).									
J3-1	PGOOD	PGOOD monitor pin									
J3-2	GND	GND									
J3-3	GND	GND									
J3-4	HIC/LATCH	HIC/LATCH monitor pin									
J4	VIN - GND	Test point to monitor VIN input voltage (Do Not short with jumper).									
J5	FB - GND	Test point to monitor FB voltage (Do Not short with jumper).									
J6	SS - GND	Test point to monitor SS voltage (Do Not short with jumper).									
J7	COMP - GND	Test point to monitor COMP voltage (Do Not short with jumper).									
J8	IMON/DE - GND	Test point to monitor IMON/DE voltage. Default setting, a jumper is populated at J8 (shorted to GND) and average current limit is disabled. To activate 4A average current limit feature, remove J8. To adjust the average current limit level, replace resistor (R ₄) between IMON/DE and GND. (Do Not short both J8 and J11 with jumper at same time).									
J9	ISEN1P - GND	Test Point to monitor ISEN1P waveform. (Do Not short with jumper) For accurate monitoring of the voltage difference between ISEN1P and ISEN1N, place a differential probe between Pin 2 of J9 and Pin 2 of J16.									
J10	GND - EN - VIN	EN signal input terminal. Connect an external enable signal (no higher than VCC voltage) between Pin 1 and Pin 2 of J10 to manually enable/disable the system. <table border="1" data-bbox="477 1083 1442 1236"> <thead> <tr> <th>STATUS</th> <th>MIN VOLTAGE FOR EN PIN* (V)</th> <th>MAX VOLTAGE FOR EN PIN* (V)</th> </tr> </thead> <tbody> <tr> <td>ISL78268 Enabled</td> <td>1.2</td> <td>VCC Voltage</td> </tr> <tr> <td>ISL78268 Disabled</td> <td>0</td> <td>1.1</td> </tr> </tbody> </table> <p>*All voltages in this table are relative to potential at GND (J2). If J28 is shorted with a jumper, short between Pin 2 and Pin 3 of J10 to enable the system automatically when VIN is applied.</p>	STATUS	MIN VOLTAGE FOR EN PIN* (V)	MAX VOLTAGE FOR EN PIN* (V)	ISL78268 Enabled	1.2	VCC Voltage	ISL78268 Disabled	0	1.1
STATUS	MIN VOLTAGE FOR EN PIN* (V)	MAX VOLTAGE FOR EN PIN* (V)									
ISL78268 Enabled	1.2	VCC Voltage									
ISL78268 Disabled	0	1.1									
J11	IMON/DE -VCC	Short with jumper to make the system operate with Forced PWM mode. Diode Emulation Mode (DE mode) will be disabled (Do Not short both J8 and J11 with jumper at same time).									
J12	VCC - GND	Test point to monitor the VCC voltage (Do Not short with jumper).									
J13	GND - HIC/LATCH - VCC	Protection operation mode (hiccup/latch-off) selection pins. Connect to VCC with jumper for hiccup operation or short to GND for latch-off operation (Do Not short both side at the same time).									
J14	PGOOD - GND	Test point to monitor PGOOD output (Do Not short with jumper).									
J15	PH - UG	Test point to monitor the gate voltage (Gate-to-Source voltage) of the high side transistor (Do Not short with jumper).									
J16	ISEN1N - GND	Test point to monitor ISEN1N waveform. (Do Not short with jumper) For accurate monitoring of the voltage difference between ISEN1P and ISEN1N, place a differential probe between Pin 2 of J9 and Pin 2 of J16.									
J17	FSYNC - GND	External synchronization clock input terminal or test point for the FSYNC pin voltage (Do Not short with jumper).									
J18	LG - GND	Test point to monitor the gate voltage of the low side transistor (Do Not short with jumper).									
J19	CLKOUT - GND	Test point to monitor the output clock (Do Not short with jumper).									
J20	PHASE - GND	Test point to monitor the PHASE waveform (Do Not short with jumper).									
J21	PVCC - GND	Test point to monitor the internal LDO output voltage (PVCC) (Do Not short with jumper).									

TABLE 1. ISL78268EV1ZB CONNECTOR/MONITOR-PIN DESCRIPTION (Continued)

CONNECTOR/ TERMINAL	SIGNAL NAME	DESCRIPTIONS
J22	ISEN2P - GND	Test point to monitor ISEN2P waveform (Do Not short with jumper). For accurate monitoring of the voltage difference between ISEN2P and ISEN2N, place a differential probe between Pin 2 of J22 and Pin 2 of J23.
J23	ISEN2N - GND	Test point to monitor ISEN2N waveform (Do Not short with jumper). For accurate monitoring of the voltage difference between ISEN2P and ISEN2N, place a differential probe between Pin 2 of J22 and Pin 2 of J23.
J24	VOOUT - GND	Test point to monitor the output voltage (VOOUT) (Do Not short with jumper).
J26	VOOUT	Positive terminal of buck regulator output (Do Not short with jumper).
J27	GND	Negative terminal of buck regulator output. (ground).
J28	EN - VIN	To enable the system automatically when VIN is applied, short J28 with a jumper and also short between Pin 2 and Pin 3 of J10.

Quick Start Guide

Setup of Test Equipment

- Prepare 2 Power Supplies, 1 Electric Load, 4 Digital Multimeters (DMM) and 1 Oscilloscope.
 - The first power supply (VIN Power Supply) will be used for the VIN power rail and should have the capability to supply up to 60V/5A.
 - The second power supply (EN Power Supply) will be used to supply bias for EN and should have the capability to supply 5V/0.5A. This power supply is not necessary if EN is connected to VIN with J28 and J10.
 - The Electric Load (or Resistive Load) will be used as the load for VOOUT and should have a capability to sink up to 20A.
 - The DMMs will be used to monitor the output voltage, the output current, the input voltage and the input current.
- External Connections
 - Connect the VIN Power Supply between VIN(J1) and GND(J2).
 - Connect the EN Power Supply (if used) between EN and GND (J28-center and GND side).
 - Connect the Electric Load between VOOUT(J26) and GND(J27).
 - Place the DMMs appropriately where the parameters are to be measured. The input and output voltage can be measured using J4 and J24. The input and output current should be monitored in series with the respective positive terminals of VIN and VOOUT.

NOTE: To measure the voltage of high current nodes, it is recommended to use Kelvin connection to avoid the effect of parasitic resistances of the connections. These connections are supplied at J4 and J24.

- Recommended Power Supply and Load set up
 - Set the EN Power Supply voltage to 3.3V. At this time, the power supply output should remain off.
 - Set the VIN Power Supply voltage to 36V (15V~55V). At this time, the power supply output should remain off.
 - Set the Electric Load to 0A. At this time, the load should remain off.

Measurement Setup

On the ISL78268 Evaluation Board, user can select the following operation modes; fault response (Hiccup or Latch-off), switching mode (Diode Emulation mode or Forced PWM mode) and Average Current Limit (ACL) by changing the connection of the HIC/LATCH and IMON/DE jumper pins. [Table 2 on page 6](#) shows the detailed jumper pin settings for different operation modes. Three typical operation modes examples are shown as follows:

1. Diode Emulation Mode Enabled/Hiccup Mode Enabled/ACL disabled

- Short a jumper between HIC/LATCH and VCC at J13 to set to Hiccup Mode
- Short a jumper between IMON/DE and GND at J8 to disable the Average Current Limit
- Ensure the jumper between IMON/DE and VCC at J11 is removed (open) to operate in DE Mode

1.1. Power-up and Initial Confirmation

- Turn on the output of VIN Power Supply. Keep EN Power Supply output off.
 - Keep the Electric Load off
 - Confirm the voltage applied to VIN of the evaluation board is correct.
 - Confirm the supply current of VIN Power Supply is less than 3μA.
 - Sweep VIN from 15V to 55V
 - Confirm the supply current of VIN Power supply is less than 10μA at all input voltages.
 - Set VIN Power Supply to 36V (or desired voltage) and enable the output of the EN Power Supply.
 - Keep the electric load off.
 - Confirm the evaluation board output voltage is 12V.
 - Confirm the PVCC voltage is 5.2V.
 - Confirm the supply current of VIN Power Supply is approximately 5mA.
 - Confirm the frequency of the output clock from CLKOUT (J19) is approximately 300kHz and the pulse width is approximately 270ns.
 - Confirm the pulse skipping switching at PHASE node (J20).

1.2. Functional Confirmation and Measurement

- Normal Operation with DE Mode operation at light load.
 - Set the VIN Power Supply to the desired input voltage, then turn on electric load and set the load current at desired value.
 - Confirm the Evaluation Board output voltage, output current, input current, efficiency, operation mode etc.
- Overcurrent Protection.
 - Set the VIN Power Supply to the desired input voltage and sweep the load current from 0A.
 - Confirm that at the OC1 level, On-duty becomes shorter and VOUT starts to drop. Continue to increase the current and confirm the device triggered into Hiccup operation.

2. DE Mode Enabled/Hiccup Mode Enabled/ACL Enabled

- Short a jumper between HIC/LATCH and VCC at J13 to set to Hiccup Mode.
- Remove a jumper between IMON/DE and GND at J8 to enable the Average Current Limit.
- Keep jumper between IMON/DE and VCC at J11 open to operate in DE Mode.
- Enable the system as in 1.1.
- Confirm the Input voltage, Output voltage, Load current, operation mode and ACL functionality etc. When IMON/DE

pin voltage reaches 1.6V, ACL will be triggered. While in ACL, On-duty becomes shorter and output voltage drops to keep the output current at the same level.

- Turn off the VIN power supply.

3. Forced PWM Mode Enabled/Latch-off Mode Enabled/ACL Disabled

- Short a jumper between HIC/LATCH and GND at J13 to set to latch-off mode.
- Remove a jumper between IMON/DE and GND at J8.
- Short a jumper between IMON/DE and VCC at J11 to operate in forced PWM mode. In forced PWM mode, the device always operates in full synchronous mode. In light load condition, the negative current from VOUT to VIN will be observed.
- Enable the system as in 1.1.
- Confirm the Input voltage, output voltage, load current, operation mode and OC2 functionality etc. When Latch-off is triggered, the device stops switching and keeps switching off until the EN or VIN is toggled.
- Turn off the VIN power supply.

4. For more combinations of mode settings, please refer to [Table 2](#).

TABLE 2. ISL78268EV1Z MODE SETTING EXAMPLE

CONNECTOR/ TERMINAL	SIGNAL NAME	SETTING EXAMPLE				
		INTERNAL CLOCK/ HICCUP/ DE MODE/ ACL ENABLED (DEFAULT SETTING)	INTERNAL CLOCK/ HICCUP/ DE MODE/ ACL DISABLED	INTERNAL CLOCK/ LATCH-OFF/ FORCED PWM/ ACL DISABLED	SYNC WITH EXT CLOCK/ HICCUP/ FORCED PWM/ ACL DISABLED	SYNC WITH EXT CLOCK/ LATCH-OFF/ DE MODE/ ACL ENABLED
J1	VIN	VIN +	VIN +	VIN +	VIN +	VIN +
J2	GND	VIN - (GND)	VIN - (GND)	VIN - (GND)	VIN - (GND)	VIN - (GND)
J3	PGOOD - GND - GND - HIC/LATCH	Open	Open	Open	Open	Open
J4	VIN - GND	Open	Open	Open	Open	Open
J5	FB - GND	Open	Open	Open	Open	Open
J6	SS - GND	Open	Open	Open	Open	Open
J7	COMP -GND	Open	Open	Open	Open	Open
J8	IMON/DE - GND	Open (J11 Open = ACL Enabled and DE mode selected)	Short to GND (J11 Open = DE mode selected)	Open (J11 Short to VCC = ACL Disabled and Forced PWM mode selected)	Open (J11 Short to VCC = ACL Disabled and Forced PWM mode selected)	Open (J11 Open = ACL Enabled and DE mode selected)
J9	ISEN1P - GND	Open	Open	Open	Open	Open
J10	EN	Connect to Ext. EN signal for external On/Off control. Or, short J28 to VCC and short J10 Pin 2-3 for self start-up when VIN applied.	Connect to Ext. EN signal for external On/Off control. Or, short J28 to VCC and short J10 Pin 2-3 for self start-up when VIN applied.	Connect to Ext. EN signal for external On/Off control. Or, short J28 to VCC and short J10 Pin 2-3 for self start-up when VIN applied.	Connect to Ext. EN signal for external On/Off control. Or, short J28 to VCC and short J10 Pin 2-3 for self start-up when VIN applied.	Connect to Ext. EN signal for external On/Off control. Or, short J28 to VCC and short J10 Pin 2-3 for self start-up when VIN applied.

TABLE 2. ISL78268EV1Z MODE SETTING EXAMPLE (Continued)

CONNECTOR/ TERMINAL	SIGNAL NAME	SETTING EXAMPLE				
		INTERNAL CLOCK/ HICCUP/ DE MODE/ ACL ENABLED (DEFAULT SETTING)	INTERNAL CLOCK/ HICCUP/ DE MODE/ ACL DISABLED	INTERNAL CLOCK/ LATCH-OFF/ FORCED PWM/ ACL DISABLED	SYNC WITH EXT CLOCK/ HICCUP/ FORCED PWM/ ACL DISABLED	SYNC WITH EXT CLOCK/ LATCH-OFF/ DE MODE/ ACL ENABLED
J11	IMON/DE -VCC	Open (DE mode)	Open (DE mode)	Short to VCC (Forced PWM mode)	Short to VCC (Forced PWM mode)	Open (DE mode)
J12	VCC - GND	Open	Open	Open	Open	Open
J13	GND - HIC/LATCH - VCC	Short to VCC (Hiccup mode)	Short to VCC (Hiccup mode)	Short to GND (Latch-off mode)	Short to VCC (Hiccup mode)	Short to GND (Latch-off mode)
J14	PGOOD - GND	Open	Open	Open	Open	Open
J15	PHASE - UG	Open	Open	Open	Open	Open
J16	ISEN1N - GND	Open	Open	Open	Open	Open
J17	FSYNC - GND	Open	Open	Open	Open	Open
J18	LG - GND	Open	Open	Open	Open	Open
J19	CLKOUT - GND	Open	Open	Open	Open	Open
J20	PHASE - GND	Open	Open	Open	Open	Open
J21	PVCC - GND	Open	Open	Open	Open	Open
J22	ISEN2P - GND	Open	Open	Open	Open	Open
J23	ISEN2N - GND	Open	Open	Open	Open	Open
J24	VOUT - GND	Open	Open	Open	Open	Open
J26	VOUT	Positive Terminal of Load	Positive Terminal of Load	Positive Terminal of Load	Positive Terminal of Load	Positive Terminal of Load
J27	GND	Negative Terminal of Load	Negative Terminal of Load	Negative Terminal of Load	Negative Terminal of Load	Negative Terminal of Load
J28	EN - VIN	Open	Open	Open	Open	Open

ISL78268EVAL1Z Schematic

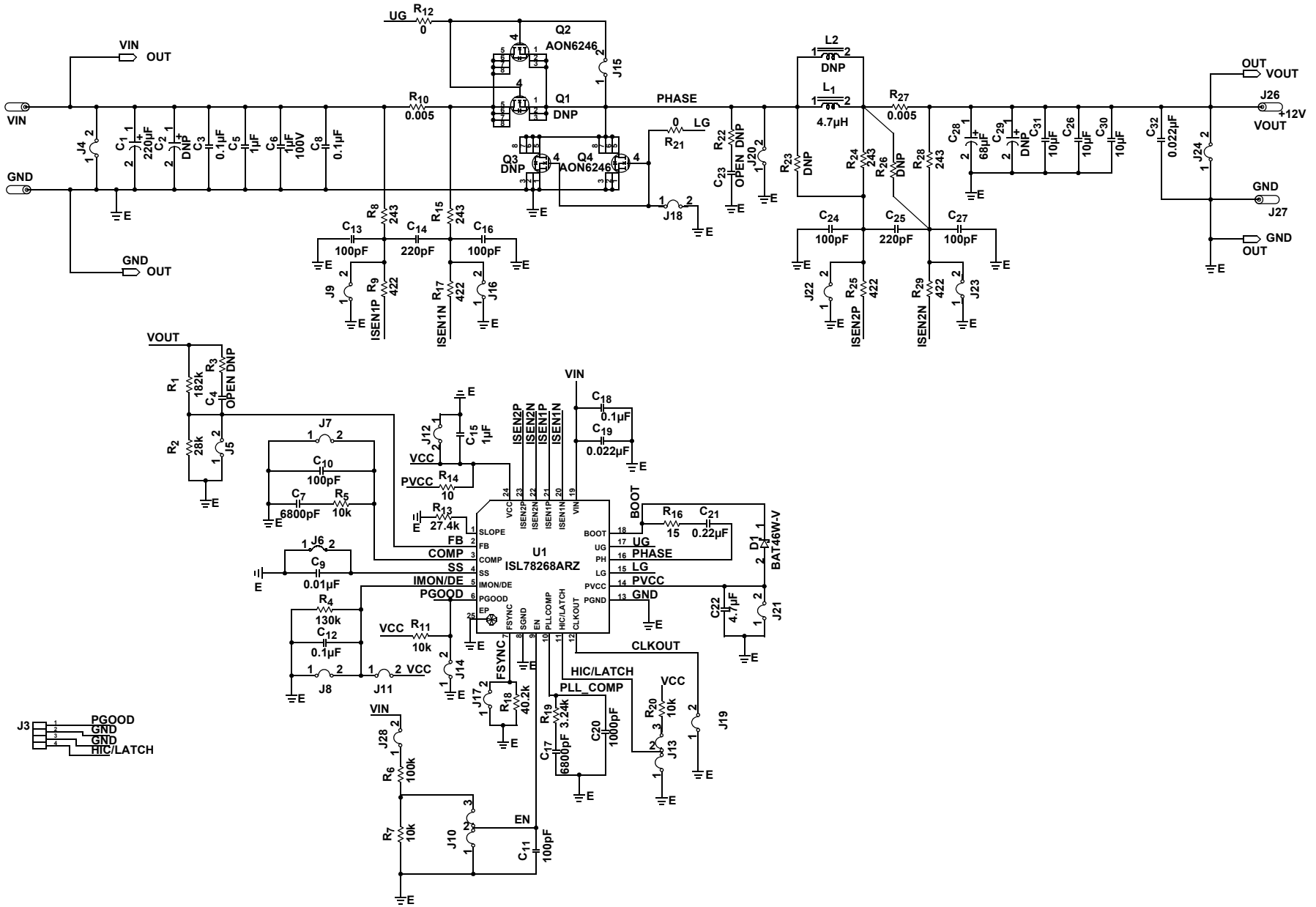

FIGURE 4. SCHEMATIC

TABLE 3. ISL78268EVAL1Z BUILD OF MATERIALS LIST

REFERENCE DESIGNATOR	QTY	UNITS	COMPONENT TYPE	VALUE	RATING	ACCURACY (%)	TYPE	SIZE	OTHER DESCRIPTION	MANUFACTURER	MANUFACTURER PART
ISL78268EVAL1Z REV. B	1	ea.	PCB						PWB-PCB, ISL78268EVAL1Z-REVB, ROHS	IMAGINEERING INC	ISL78268EVAL1ZREVBPCB
C15	1	ea.	Capacitor, Ceramic	1.0µF	16V	10	X7R	0603	SMD, ROHS	TDK	C1608X7R1C105K
C22	1	ea.	Capacitor, Ceramic	4.7µF	16V	10	X7R	0805	SMD, ROHS	MURATA	GRM21BR71C475KA73L
C13, C16, C24, C27	4	ea.	Capacitor, Ceramic	100pF	100V	5	COG	0603	SMD, ROHS	PANASONIC	ECJ-1VC2A101J
C10, C11	2	ea.	Capacitor, Ceramic	100pF	50V	5	COG	0603	SMD, ROHS	PANASONIC	ECJ-1VC1H101J
C20	1	ea.	Capacitor, Ceramic	1000pF	25V	10	X7R	0603	SMD, ROHS	AVX	08053C102KAT2A
C9	1	ea.	Capacitor, Ceramic	0.01µF	50V	10	X7R	0603	SMD, ROHS	MURATA	GRM39X7R103K050
C12	1	ea.	Capacitor, Ceramic	0.1µF	25V	10	X7R	0603	SMD, ROHS	MURATA	GRM39X7R104K025AD
C14, C25	2	ea.	Capacitor, Ceramic	220pF	50V	10	X7R	0603	SMD, ROHS	MURATA	GRM188R71H221KA01D
C19, C32	2	ea.	Capacitor, Ceramic	0.022µF	100V	10	X7R	0603	SMD, ROHS	VENKEL	C0603X7R101-223KNE
C21	1	ea.	Capacitor, Ceramic	0.22µF	16V	10	X7R	0603	SMD, ROHS	TDK	C1608X7R1C224K
C7, C17	2	ea.	Capacitor, Ceramic	6800pF	50V	10	X7R	0603	SMD, ROHS	AVX	06035C682KAT9A
C3, C8, C18	3	ea.	Capacitor, Ceramic	0.1µF	100V	10	X7R	0805	SMD, ROHS	TDK	C2012X7R2A104K
C5, C6	2	ea.	Capacitor, Ceramic	1.0µF	100V	10	X7R	1206	SMD, ROHS	VENKEL	C1206X7R101-105KNE
C26, C30, C31	3	ea.	Capacitor, Ceramic	10µF	16V	10	X5R	1206	SMD, ROHS	VENKEL	C1206X5R160-106KNE (Pb-Free)
C4	0	ea.	Capacitor, Ceramic	not placed				0603	SMD, Not Placed, Place-Holder for type-3 compensation, ROHS		
C23	0	ea.	Capacitor, Ceramic	not placed				0603	SMD, Not Placed, Place-Holder, ROHS		
C28	1	ea.	Capacitor, Alum. Polymer	68µF	25V	20	Alum. Polymer	8x11.5	RADIAL, 24mΩ, ROHS	UNITED CHEMI-CON	APS-250ELL680MHB5S
C1	1	ea.	Capacitor, Alum. Electrolytic	220µF	80V	20	Alum. Electrolytic	12.5x20	RADIAL, ROHS	UNITED CHEMI-CON	EKZE800ELL221MK20S

TABLE 3. ISL78268EVAL1Z BUILD OF MATERIALS LIST (Continued)

REFERENCE DESIGNATOR	QTY	UNITS	COMPONENT TYPE	VALUE	RATING	ACCURACY (%)	TYPE	SIZE	OTHER DESCRIPTION	MANUFACTURER	MANUFACTURER PART
C2,C29	0	ea.	Capacitor	Not Placed					Not Placed. Place-holder for additional input and output cap		
L1	1	ea.	Inductor	6.8μH		20		7.5x7.2	SMD, 17.84mΩ, ROHS	COILCRAFT	XAL7070-682MEB
L2 (HC9-100-R)	0	ea.	Inductor	Not Placed					Not Placed. Place-holder for other Inductor		
D1	1	ea.	Diode-Schottky		100V 200m W			SOD-123	SMD, ROHS	DIODES INC.	BAT46W-7-F
U1	1	ea.	IC					4x4, 24-pin QFB	ISL78268-Synchronous Buck Regulator, ROHS	INTERSIL	ISL78268ARZ
Q2, Q4	2	ea.	Transistor, NMOS		60V, 80A			5x6, 8-pin DFN	ROHS	ALPHA and OMEGA SEMICONDUCTOR	AON6246
Q1,Q3	0	ea.	Transistor, NMOS	Not Placed				5x6, 8-pin DFN	Not Placed. Place-holder for additional NMOS-FET		
R22	0	ea.	Resistor	Not placed				0805	SMD, Not Placed		
R14	1	ea.	Resistor	10Ω	1/10W	1	Thick Film	0603	SMD, ROHS	KOA	RK73H1JT10R0F
R16	1	ea.	Resistor	15Ω	1/10W	1	Thick Film	0603	SMD, ROHS	YAGEO	RC0603FR-0715RL
R12, R21	2	ea.	Resistor	0Ω	1/10W		Thick Film	0603	SMD, ROHS	VENKEL	CR0603-10W-000T
R5, R7, R11, R20	4	ea.	Resistor	10kΩ	1/10W	1	Thick Film	0603	SMD, ROHS	KOA	RK73H1JT1002F
R4	1	ea.	Resistor	130kΩ	1/10W	1	Thick Film	0603	SMD, ROHS	PANASONIC	ERJ-3EKF1303V
R1	1	ea.	Resistor	182kΩ	1/10W	1	Thick Film	0603	SMD, ROHS	YAGEO	RC0603FR-07182KL
R8, R15, R24, R28	4	ea.	Resistor	243Ω	1/10W	1	Thick Film	0603	SMD, ROHS	YAGEO	RC0603FR-07243RL
R13	1	ea.	Resistor	27.4kΩ	1/10W	1	Thick Film	0603	SMD, ROHS	PANASONIC	ERJ-3EKF2742V
R2	1	ea.	Resistor	28kΩ	1/10W	1	Thick Film	0603	SMD, ROHS	VENKEL	CR0603-10W-2802FT
R19	1	ea.	Resistor	3.24kΩ	1/10W	1	Thick Film	0603	SMD, ROHS	PANASONIC	ERJ-3EKF3241V
R18	1	ea.	Resistor	40.2kΩ	1/10W	1	Thick Film	0603	SMD, ROHS	YAGEO	RC0603FR-0740K2L
R9, R17, R25, R29	4	ea.	Resistor	422Ω	1/10W	1	Thick Film	0603	SMD, ROHS	PANASONIC	ERJ-3EKF4220V
R6	1	ea.	Resistor	100kΩ	1/8W	1	Thick Film	0805	SMD, ROHS	VENKEL	CR0805-8W-1003FT
R10,R27	2	ea.	Resistor	0.005Ω	2/3W	1	Thin-Film	0805	Current Sense Resistor, SMD, ROHS	SUSUMU	KRL2012-M-R005-F
R3	0	ea.	Resistor	not placed				0603	SMD, Not Placed, Place-Holder for Type-3 compensation		
R23, R27	0	ea.	Resistor	not placed				0603	SMD, Not Placed, Place-Holder for DCR Current Sensing		
J1, J2, J26, J27	4	ea.	Connector, Jack					0.175 PLUG	MINI BANANA, NICKEL/BRASS, ROHS	KEYSTONE	575-4

TABLE 3. ISL78268EVAL1Z BUILD OF MATERIALS LIST (Continued)

REFERENCE DESIGNATOR	QTY	UNITS	COMPONENT TYPE	VALUE	RATING	ACCURACY (%)	TYPE	SIZE	OTHER DESCRIPTION	MANUFACTURER	MANUFACTURER PART
J3	1	ea.	Connector, Header					1x4, 2.54mm pitch	SOLID, VERTICAL, FRICTION LOCK, GOLD	MOLEX	22-11-2042
J10, J13	2	ea.	Connector, Header					1x3, 2.54mm pitch	CONN-HEADER, Breakaway1X36, ROHS	BERG/FCI	68000-236HLF
J4-J9, J11, J12, J14-J24, J28	20	ea.	Connector, Header					1x2, 2.54mm pitch	RETENTIVE, ROHS	BERG/FCI	69190-202HLF
Four corners	4	ea.	Screw					4-40x1/4in	PAN, SS, PHILLIPS		
Four corners	4	ea.	Standoff					4-40x3/4in	F/F, HEX, ALUMINUM, ROHS	KEYSTONE	2204 (.250 OD)
AFFIX TO BACK OF PCB	1	ea.	Label						LABEL-DATE CODE_LINE 1: YRWK/REV#, LINE 2: BOM NAME	INTERSIL	LABEL-DATE CODE
Place assy in bag	1	ea.	Anti-static Bag					5x8 in	Anti-Static Bag, ZIPLOC, ROHS	INTERSIL	212403-013

Layout Pattern (4-layers)

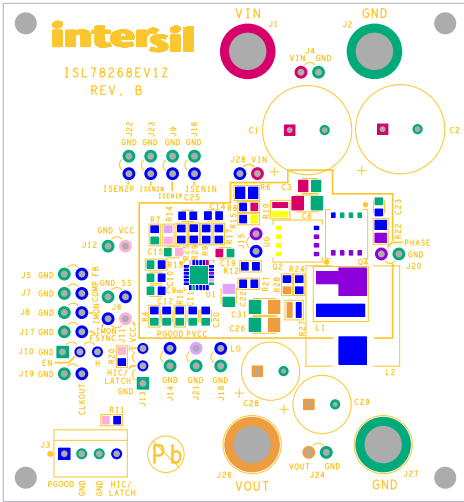

FIGURE 5. SILK PATTERN (TOP)

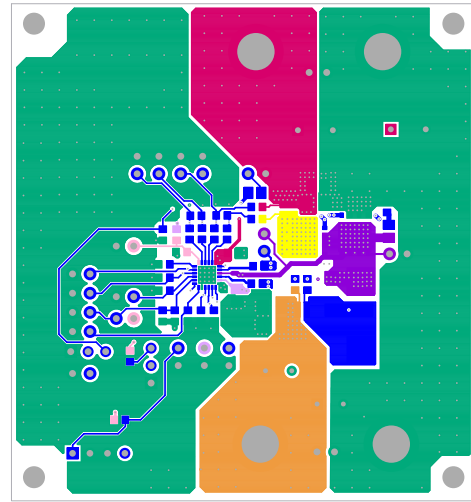

FIGURE 6. TOP LAYER

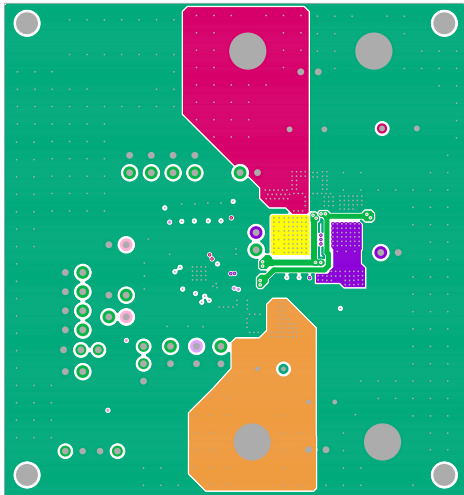

FIGURE 7. LAYER 2

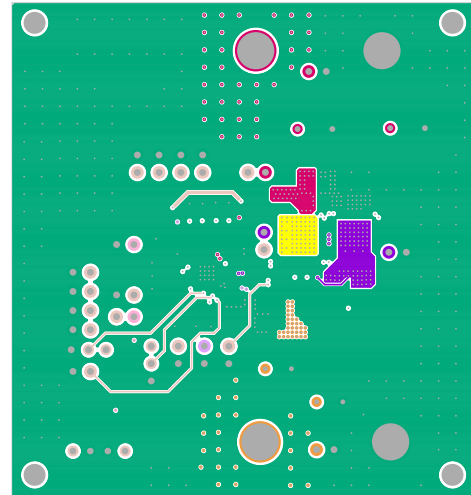

FIGURE 8. LAYER 3

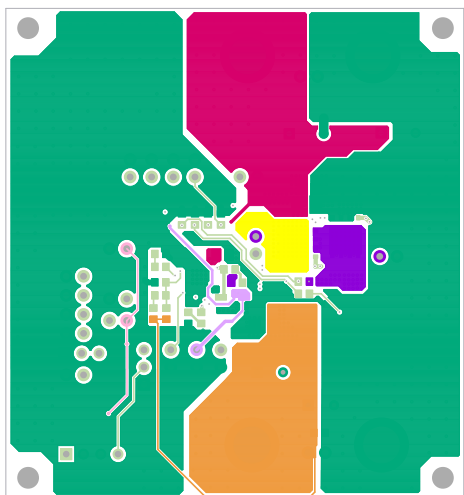

FIGURE 9. BOTTOM LAYER

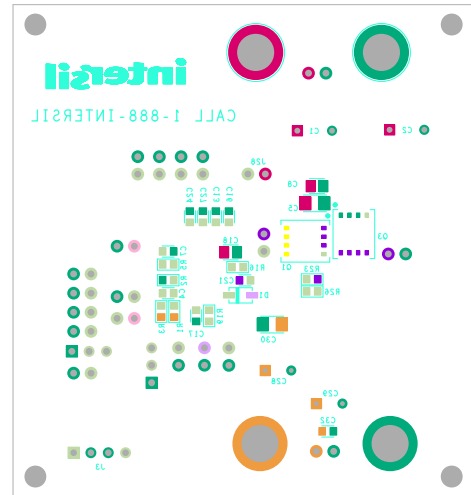

FIGURE 10. SILK PATTERN (BOTTOM)

Typical Performance Curves

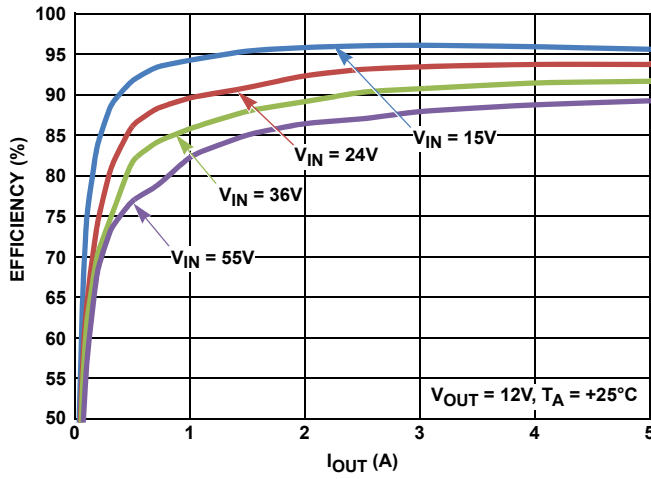

FIGURE 11. EFFICIENCY (AT +25 °C): DE MODE, $V_{OUT} = 12V$, $L = 4.7\mu H$, $f_{SW} = 300kHz$

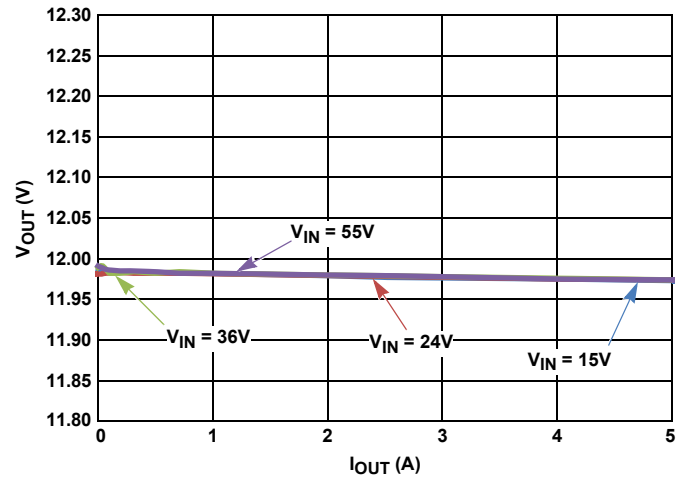

FIGURE 12. LOAD REGULATION

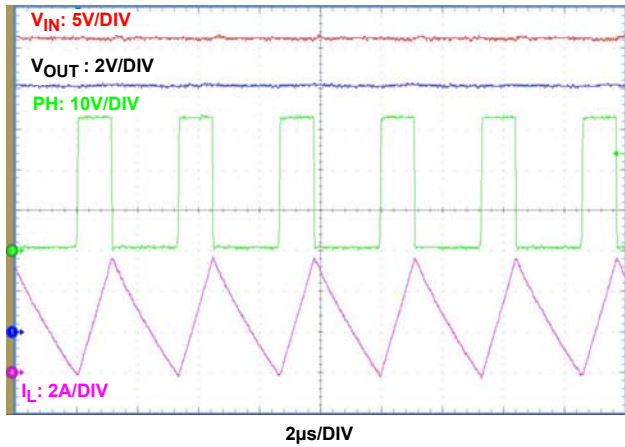

FIGURE 13. DE MODE: $V_{IN} = 36V$, $V_{OUT} = 12V$, $I_{OUT} = 2.5A$, $L = 4.7\mu H$, $C_{OUT} = 98\mu F$, $f_{SW} = 300kHz$ (CONTINUOUS CONDUCTION OPERATION)

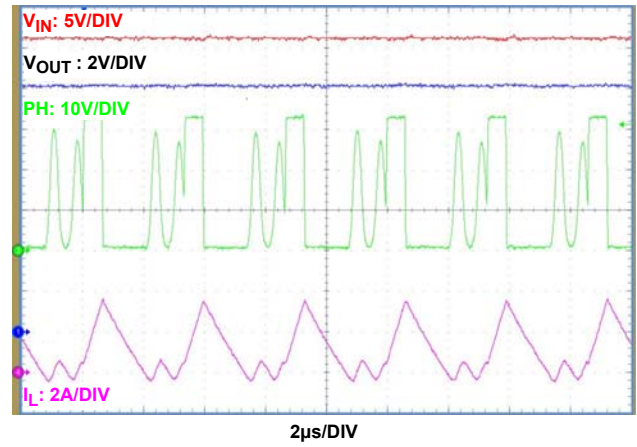

FIGURE 14. DE MODE: $V_{IN} = 36V$, $V_{OUT} = 12V$, $I_{OUT} = 1.0A$, $L = 4.7\mu H$, $C_{OUT} = 98\mu F$, $f_{SW} = 300kHz$ (DISCONTINUOUS CONDUCTION OPERATION)

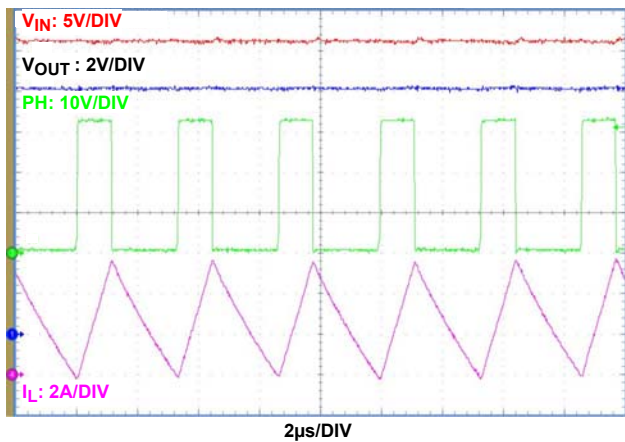

FIGURE 15. FORCED PWM MODE, $V_{IN} = 36V$, $V_{OUT} = 12V$, $I_{OUT} = 2.5A$, $L = 4.7\mu H$, $C_{OUT} = 98\mu F$, $f_{SW} = 300kHz$

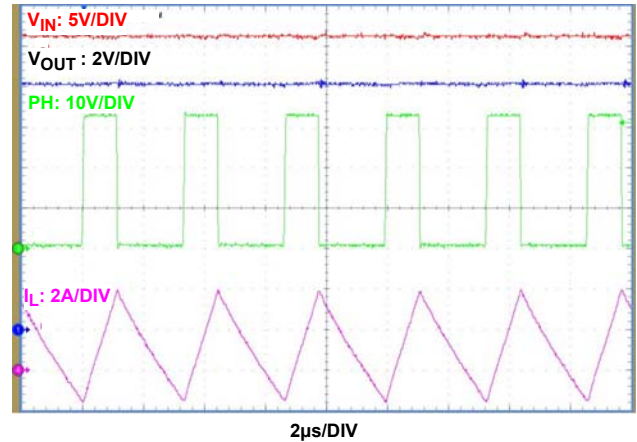

FIGURE 16. FORCED PWM MODE, $V_{IN} = 36V$, $V_{OUT} = 12V$, $I_{OUT} = 1.0A$, $L = 4.7\mu H$, $C_{OUT} = 98\mu F$, $f_{SW} = 300kHz$

Typical Performance Curves (Continued)

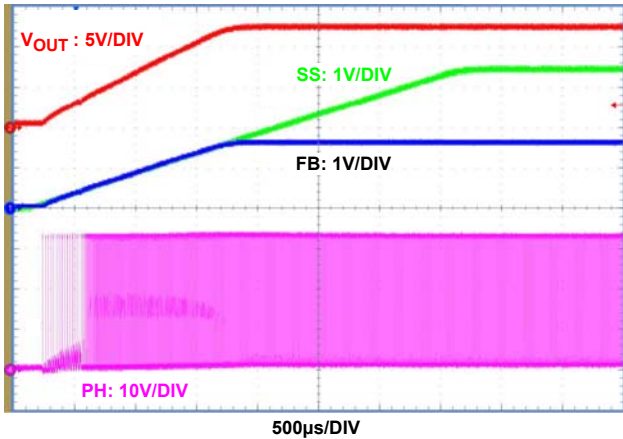

FIGURE 17. SOFT-START (NON-PREBIASED): DE MODE, $V_{IN} = 36V$, $V_{OUT} = 12V$, $I_{OUT} = 2.5A$, $L = 4.7\mu H$, $C_{OUT} = 98\mu F$, $f_{SW} = 300kHz$

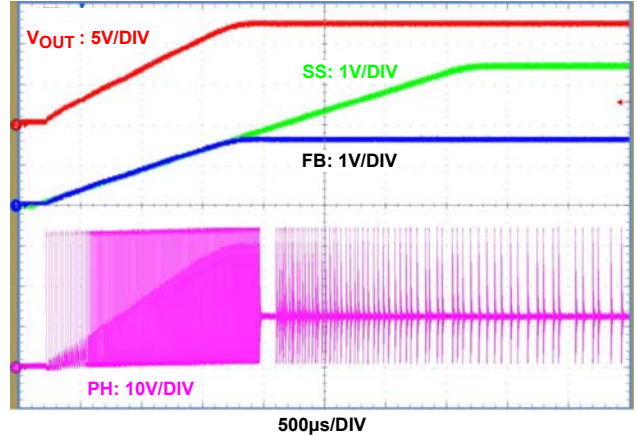

FIGURE 18. SOFT-START (NON-PREBIASED): DE MODE, $V_{IN} = 36V$, $V_{OUT} = 12V$, $I_{OUT} = 0A$, $L = 4.7\mu H$, $C_{OUT} = 98\mu F$, $f_{SW} = 300kHz$

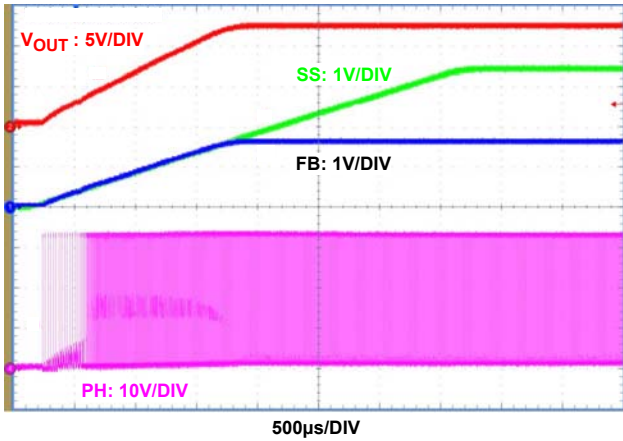

FIGURE 19. SOFT-START (NON-PREBIASED): FORCED-PWM MODE, $V_{IN} = 36V$, $V_{OUT} = 12V$, $I_{OUT} = 2.5A$, $L = 4.7\mu H$, $C_{OUT} = 98\mu F$, $f_{SW} = 300kHz$

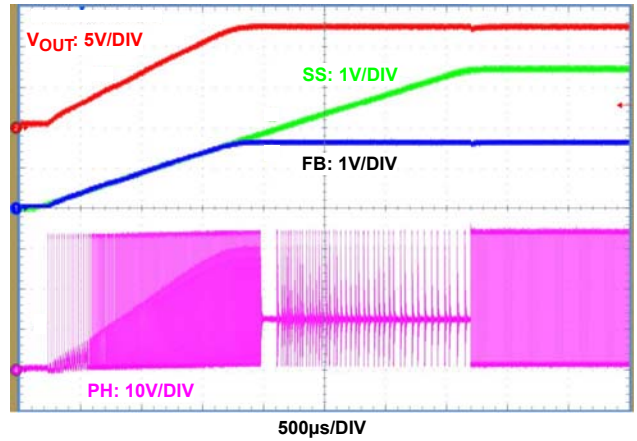

FIGURE 20. SOFT-START (NON-PREBIASED): FORCED-PWM MODE, $V_{IN} = 36V$, $V_{OUT} = 12V$, $I_{OUT} = 0A$, $L = 4.7\mu H$, $C_{OUT} = 98\mu F$, $f_{SW} = 300kHz$

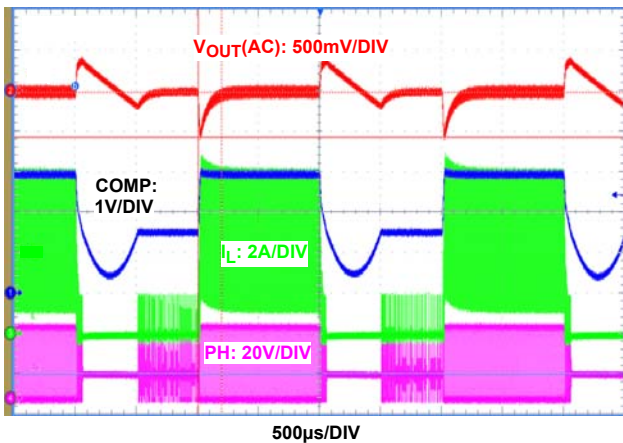

FIGURE 21. TRANSIENT RESPONSE: DE MODE, $V_{IN} = 36V$, $V_{OUT} = 12V$, $I_{OUT} = 0.1A$ TO $4.5A$, $L = 4.7\mu H$, $C_{OUT} = 98\mu F$

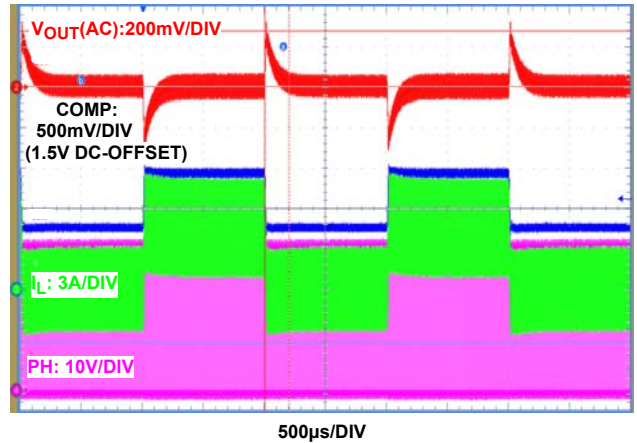

FIGURE 22. TRANSIENT RESPONSE: FORCED-PWM MODE, $V_{IN} = 36V$, $V_{OUT} = 12V$, $I_{OUT} = 0.1A$ TO $4.5A$, $L = 4.7\mu H$, $C_{OUT} = 98\mu F$

Typical Performance Curves (Continued)

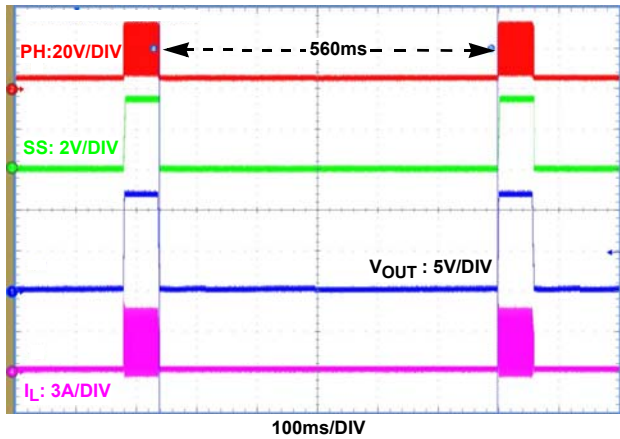

FIGURE 23. HICCUP: ACL, $V_{IN} = 30V$, $V_{OUT} = 12V$, $R_{IMON} = 156k\Omega$

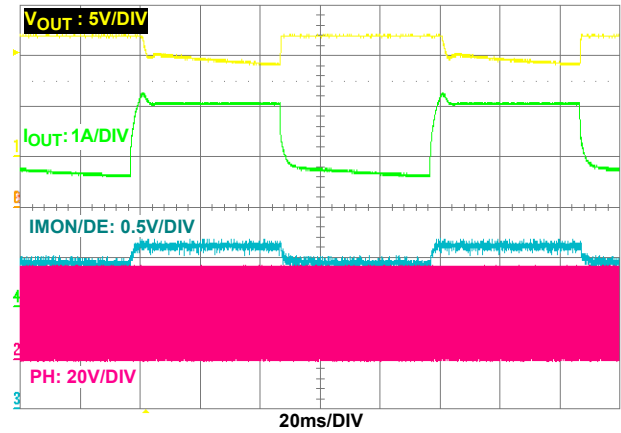

FIGURE 24. AVERAGE CONSTANT OUTPUT CURRENT CONTROL, $V_{IN} = 36V$, $V_{OUT} (\text{SETTING}) = 12V$, $C_{IMON} = 1nF$, $R_{IMON} = 130k\Omega$, $ACL = 4.05A$, $R_L = 5.0\Omega$ TO 2.0Ω , $F_{LOAD} = 10Hz$, DUTY OF LOAD CHANGE = 50%

Notice

1. Descriptions of circuits, software and other related information in this document are provided only to illustrate the operation of semiconductor products and application examples. You are fully responsible for the incorporation or any other use of the circuits, software, and information in the design of your product or system. Renesas Electronics disclaims any and all liability for any losses and damages incurred by you or third parties arising from the use of these circuits, software, or information.
2. Renesas Electronics hereby expressly disclaims any warranties against and liability for infringement or any other claims involving patents, copyrights, or other intellectual property rights of third parties, by or arising from the use of Renesas Electronics products or technical information described in this document, including but not limited to, the product data, drawings, charts, programs, algorithms, and application examples.
3. No license, express, implied or otherwise, is granted hereby under any patents, copyrights or other intellectual property rights of Renesas Electronics or others.
4. You shall not alter, modify, copy, or reverse engineer any Renesas Electronics product, whether in whole or in part. Renesas Electronics disclaims any and all liability for any losses or damages incurred by you or third parties arising from such alteration, modification, copying or reverse engineering.
5. Renesas Electronics products are classified according to the following two quality grades: "Standard" and "High Quality". The intended applications for each Renesas Electronics product depends on the product's quality grade, as indicated below.
"Standard": Computers; office equipment; communications equipment; test and measurement equipment; audio and visual equipment; home electronic appliances; machine tools; personal electronic equipment; industrial robots; etc.
"High Quality": Transportation equipment (automobiles, trains, ships, etc.); traffic control (traffic lights); large-scale communication equipment; key financial terminal systems; safety control equipment; etc.
Unless expressly designated as a high reliability product or a product for harsh environments in a Renesas Electronics data sheet or other Renesas Electronics document, Renesas Electronics products are not intended or authorized for use in products or systems that may pose a direct threat to human life or bodily injury (artificial life support devices or systems; surgical implantations; etc.), or may cause serious property damage (space system; undersea repeaters; nuclear power control systems; aircraft control systems; key plant systems; military equipment; etc.). Renesas Electronics disclaims any and all liability for any damages or losses incurred by you or any third parties arising from the use of any Renesas Electronics product that is inconsistent with any Renesas Electronics data sheet, user's manual or other Renesas Electronics document.
6. When using Renesas Electronics products, refer to the latest product information (data sheets, user's manuals, application notes, "General Notes for Handling and Using Semiconductor Devices" in the reliability handbook, etc.), and ensure that usage conditions are within the ranges specified by Renesas Electronics with respect to maximum ratings, operating power supply voltage range, heat dissipation characteristics, installation, etc. Renesas Electronics disclaims any and all liability for any malfunctions, failure or accident arising out of the use of Renesas Electronics products outside of such specified ranges.
7. Although Renesas Electronics endeavors to improve the quality and reliability of Renesas Electronics products, semiconductor products have specific characteristics, such as the occurrence of failure at a certain rate and malfunctions under certain use conditions. Unless designated as a high reliability product or a product for harsh environments in a Renesas Electronics data sheet or other Renesas Electronics document, Renesas Electronics products are not subject to radiation resistance design. You are responsible for implementing safety measures to guard against the possibility of bodily injury, injury or damage caused by fire, and/or danger to the public in the event of a failure or malfunction of Renesas Electronics products, such as safety design for hardware and software, including but not limited to redundancy, fire control and malfunction prevention, appropriate treatment for aging degradation or any other appropriate measures. Because the evaluation of microcomputer software alone is very difficult and impractical, you are responsible for evaluating the safety of the final products or systems manufactured by you.
8. Please contact a Renesas Electronics sales office for details as to environmental matters such as the environmental compatibility of each Renesas Electronics product. You are responsible for carefully and sufficiently investigating applicable laws and regulations that regulate the inclusion or use of controlled substances, including without limitation, the EU RoHS Directive, and using Renesas Electronics products in compliance with all these applicable laws and regulations. Renesas Electronics disclaims any and all liability for damages or losses occurring as a result of your noncompliance with applicable laws and regulations.
9. Renesas Electronics products and technologies shall not be used for or incorporated into any products or systems whose manufacture, use, or sale is prohibited under any applicable domestic or foreign laws or regulations. You shall comply with any applicable export control laws and regulations promulgated and administered by the governments of any countries asserting jurisdiction over the parties or transactions.
10. It is the responsibility of the buyer or distributor of Renesas Electronics products, or any other party who distributes, disposes of, or otherwise sells or transfers the product to a third party, to notify such third party in advance of the contents and conditions set forth in this document.
11. This document shall not be reprinted, reproduced or duplicated in any form, in whole or in part, without prior written consent of Renesas Electronics.
12. Please contact a Renesas Electronics sales office if you have any questions regarding the information contained in this document or Renesas Electronics products.
(Note 1) "Renesas Electronics" as used in this document means Renesas Electronics Corporation and also includes its directly or indirectly controlled subsidiaries.
(Note 2) "Renesas Electronics product(s)" means any product developed or manufactured by or for Renesas Electronics.

(Rev.4.0-1 November 2017)



SALES OFFICES

Renesas Electronics Corporation

<http://www.renesas.com>

Refer to "<http://www.renesas.com/>" for the latest and detailed information.

Renesas Electronics America Inc.
1001 Murphy Ranch Road, Milpitas, CA 95035, U.S.A.
Tel: +1-408-432-8888, Fax: +1-408-434-5351

Renesas Electronics Canada Limited
9251 Yonge Street, Suite 8309 Richmond Hill, Ontario Canada L4C 9T3
Tel: +1-905-237-2004

Renesas Electronics Europe Limited
Dukes Meadow, Millboard Road, Bourne End, Buckinghamshire, SL8 5FH, U.K.
Tel: +44-1628-651-700, Fax: +44-1628-651-804

Renesas Electronics Europe GmbH
Arcadiastrasse 10, 40472 Düsseldorf, Germany
Tel: +49-211-6503-0, Fax: +49-211-6503-1327

Renesas Electronics (China) Co., Ltd.
Room 1709 Quantum Plaza, No.27 ZhichunLu, Haidian District, Beijing, 100191 P. R. China
Tel: +86-10-8235-1155, Fax: +86-10-8235-7679

Renesas Electronics (Shanghai) Co., Ltd.
Unit 301, Tower A, Central Towers, 555 Langao Road, Putuo District, Shanghai, 200333 P. R. China
Tel: +86-21-2226-0888, Fax: +86-21-2226-0999

Renesas Electronics Hong Kong Limited
Unit 1601-1611, 16/F., Tower 2, Grand Century Place, 193 Prince Edward Road West, Mongkok, Kowloon, Hong Kong
Tel: +852-2265-6688, Fax: +852-2886-9022

Renesas Electronics Taiwan Co., Ltd.
13F, No. 363, Fu Shing North Road, Taipei 10543, Taiwan
Tel: +886-2-8175-9600, Fax: +886-2-8175-9670

Renesas Electronics Singapore Pte. Ltd.
80 Bendemeer Road, Unit #06-02 Hyflux Innovation Centre, Singapore 339949
Tel: +65-6213-0200, Fax: +65-6213-0300

Renesas Electronics Malaysia Sdn.Bhd.
Unit 1207, Block B, Menara Amcorp, Amcorp Trade Centre, No. 18, Jln Persiaran Barat, 46050 Petaling Jaya, Selangor Darul Ehsan, Malaysia
Tel: +60-3-7955-9390, Fax: +60-3-7955-9510

Renesas Electronics India Pvt. Ltd.
No.777C, 100 Feet Road, HAL 2nd Stage, Indiranagar, Bangalore 560 038, India
Tel: +91-80-67208700, Fax: +91-80-67208777

Renesas Electronics Korea Co., Ltd.
17F, KAMCO Yangjae Tower, 262, Gangnam-daero, Gangnam-gu, Seoul, 06265 Korea
Tel: +82-2-558-3737, Fax: +82-2-558-5338