

ISL8112EVAL1Z

Evaluation Board Setup Procedure

AN1539

Rev 0.00

February 22, 2010

The ISL8112 is a dual-output Synchronous Buck controller with 2A integrated driver. It features high light load efficiency which is especially preferred in systems concerned with high efficiency in wide load range, like the battery powered system. ISL8112 includes two constant on-time PWM controllers. Both outputs can operate in an output fixed mode or an adjustable mode. In fixed mode, one output can be 5V or 3.3V and the other 1.5V or 1.05V. In adjustable mode, one output can range from 0.7V to 5.5V, and the other from 0V to 2.5V (sensing output voltage directly) or up to 5V (using resistor divider voltage for voltage sensing). This device also features a linear regulator providing 3.3V/5V, or adjustable from 0.7V to 4.5V via LDOREF. The linear regulator provides up to 100mA output current with automatic linear-regulator bootstrapping to the BYP input. When in switchover, the LDO output can source up to 200mA. ISL8112 includes on-board power-up sequencing, the power-good (PGOOD_) outputs, digital soft-start, and internal soft-stop output discharge that prevents negative voltages on shutdown.

ISL8112 is implemented with constant on-time PWM control scheme which need no sense resistors and provides 100ns response to load transients while maintaining a relatively constant switching frequency. The unique ultrasonic pulse-skipping mode maintains the switching frequency above 25kHz, eliminating undesired audible noises in low frequency operation at light load. Other features include pulse skipping which maximizes efficiency in light-load applications, and fixed-frequency PWM mode which reduces RF interference in sensitive applications.

Recommended Equipment

- 0V to 25V power supply with at least 20A source current capability, battery, or notebook AC adapter.
- Two electronic loads capable of sinking current up to 15A.
- Dummy loads for the LDO's.
- Digital multimeters (DMMs).
- 100MHz quad-trace oscilloscope.
- Signal generator.

Quick Start

1. Ensure that the circuit is correctly connected to the supply and loads prior to applying any power.
2. Verify that position 2's are ON for SW1, SW2, SW3, SW4, and SW5. Make sure that no other position of each switch is ON at the same time.
3. Turn on the input power supply.
4. Verify the output voltages are correct.
5. Verify the LDOs output voltages are correct.

Evaluating the Other Output Voltage

The ISL8112EVAL1Z board outputs are preset to 5V/7A, 3.3V/7A and 5V/200mA on LDO. The V_{OUT1} can also be adjusted between 0.7V to 5.5V by changing the value of R_9 and R_{10} or R_{11} and R_{12} given by Equation 1:

$$R_{12} = \frac{R_{11}}{(V_{OUT}/V_{FB}) - 1} \quad (\text{EQ. 1})$$

where $V_{FB} = 0.7V$

- The V_{OUT2} can track OUT2REF at 1:1 ratio with input voltage range from 0.7V to 2.5V. Likewise, the LDO output can also track LDOREF at 1:2 with voltage range from 0.35V to 2.25V.

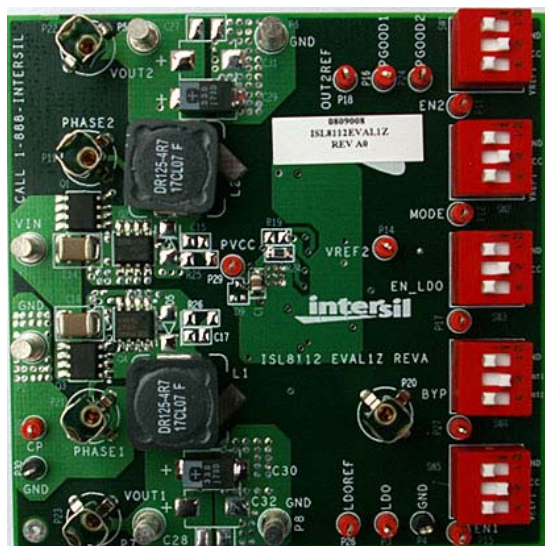

FIGURE 1. TOP VIEW

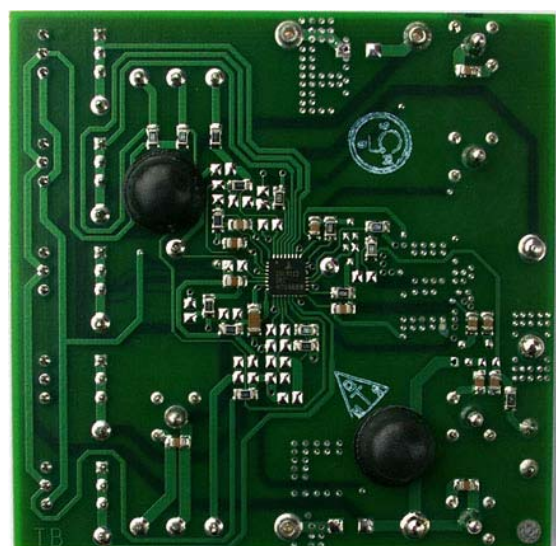

FIGURE 2. BOTTOM VIEW

ISL8112EVAL1Z Board Schematic

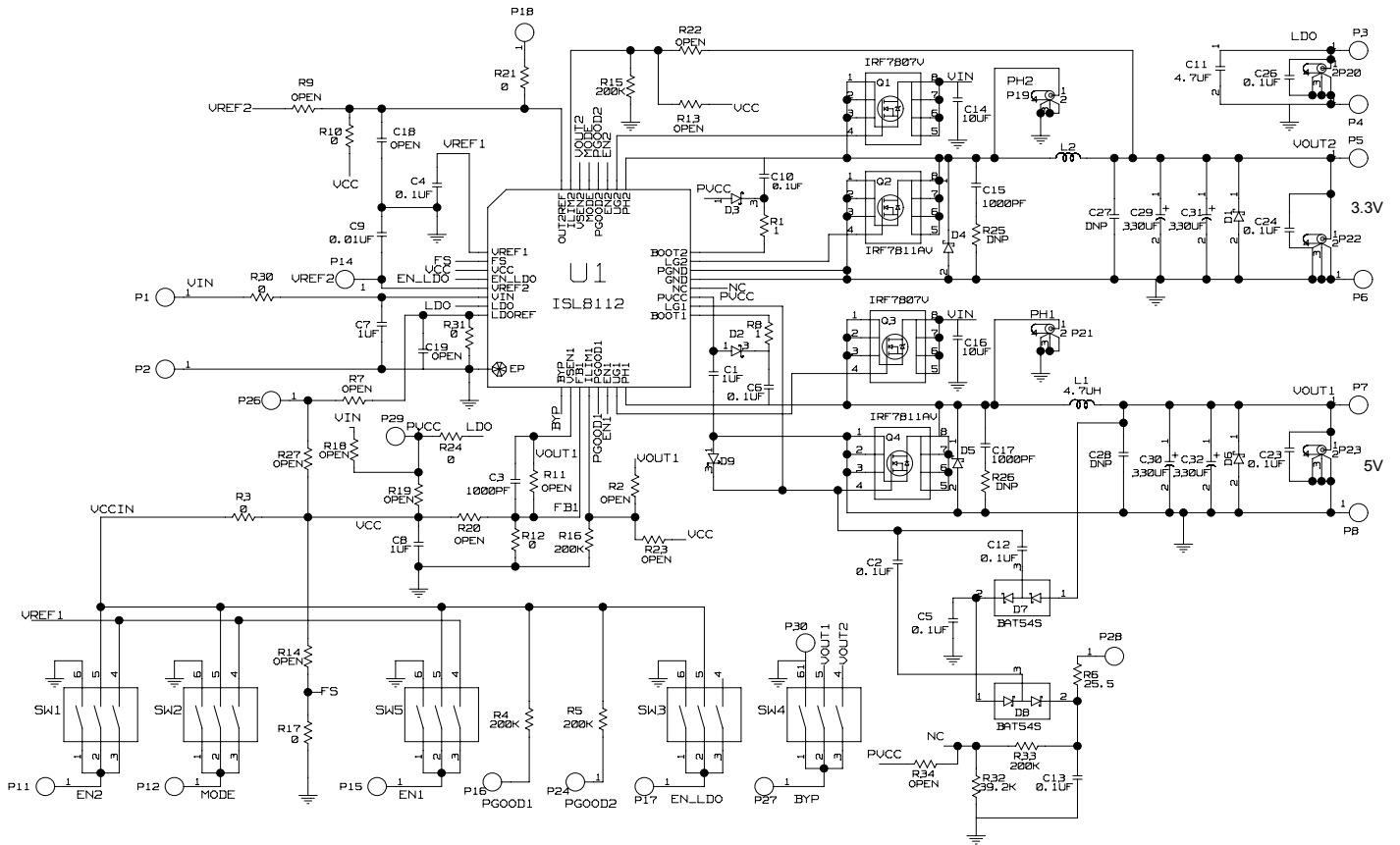

FIGURE 3. ISL8112EVAL1Z REV A BOARD SCHEMATIC

TABLE 1.

SW1	EN2	V _{OUT2} OUTPUT CONTROL
1	Connect to GND.	V _{OUT2} output shutdown.
2	Connect to VCC.	V _{OUT2} output active.
3	Connect to VREF1.	V _{OUT2} sequence to V _{OUT1} output.

NOTE: Only toggle one position at a time.

TABLE 2.

SW2	MODE	OPERATING MODE
1	Connect to GND.	Normal operation mode, allow automatic PWM/PFM switchover for pulse-skipping at light load.
2	Connect to VCC.	Low noise, fixed-frequency PWM mode.
3	Connect to VREF1.	Ultrasonic pulse-skipping mode (20kHz min.)

NOTE: Only toggle one position at a time.

TABLE 3.

SW3	EN_LDO	LDO CONTROL
1	Connect to GND.	LDO output shutdown.
2	Connect to VCC.	LDO output active.
3	N/C	No Connect.

NOTE: Only toggle one position at a time.

TABLE 4.

SW4	BYP	OPERATING MODE
1	Connect to GND.	Set BYP to 0V. No LDO switchover.
2	Connect to V _{OUT1} .	SET BYP to V _{OUT1} .
3	Connect to V _{OUT2} .	SET BYP to V _{OUT2} .

NOTE: Only toggle one position at a time.

TABLE 5.

SW5	EN1	V _{OUT1} OUTPUT CONTROL
1	Connect to GND.	V _{OUT1} output shutdown.
2	Connect to VCC.	V _{OUT1} output active.
3	Connect to VREF1.	V _{OUT1} sequence to V _{OUT2} output.

NOTE: Only toggle one position at a time.

Components List

REF DES	PART NUMBER	QTY	MANUFACTURER	DESCRIPTION
C1, C7, C8	08053D105KAT2A	3	AVX	1 μ F, 25V, X7R, 0805
C11	H1065-00475-10V10	1	GENERIC	4.7 μ F, 10V X5R 1206
C14, C16	TMK432BJ106KM	2	TAIYO-YUDEN	10 μ F, 25V X5R 1210
C2, C4, C5, C6, C10, C12, C13, C23, C24, C26	H1046-00104-50V10	10	GENERIC	0.1 μ F, 50V, X7R, 0805
C27, C28	OPEN	0	-	-
C29, C30	6TPD330M	2	POSCAP SANYO	330 μ F, 6.3V, POS CAP 9m Ω , D size
C3, C9, C15, C17, C18, C19	OPEN	0	-	-
C31, C32	OPEN	0	POSCAP	-
D1, D4-D6	OPEN	0	DIODES-INC	-
D2, D3	OPEN	0	ON-SEMI	-
D7, D8	OPEN	0	DIODES	-
D9	OPEN	0	ON-SEMI	0.3A, 30V, Schottky SOT23
L1, L2	DR125-4R7-R	2	COOPER/COILTRONICS	4.7 μ H, 10.5m Ω , 12.5x12.5mm Shielded
P1, P2, P5-P8	1514-2	6	KEYSTONE	Test Point Turret 0.150 Pad 0.100 Thole
P19-P23	131-4353-00	5	TEKTRONIX	Scope Probe Test Point PCB Mount
P3, P11, P12, P14-P18, P24, P26-P29	5000	13	KEYSTONE	Miniature Red Test Point 0.100 Pad 0.040 Thole
P4, P30	5001	2	KEYSTONE	Miniature Black Test Point 0.100 Pad 0.040 Thole

Components List (Continued)

REF DES	PART NUMBER	QTY	MANUFACTURER	DESCRIPTION
Q1	IRF7821	1	IR	30V 13.6A HEXFET Power MOSFET
Q2	IRF7832	1	IR	30V 20A HEXFET Power MOSFET
Q3	IRF7807V	1	IR	30V 8.3A N-Channel Power MOSFET
Q4	IRF7811AV	1	IR	30V 10.8A N-Channel Power MOSFET
R1, R8	H2512-01R00-1/10W	2	GENERIC	1Ω, 1%, 0805
R15	H2512-01503-1/10W1	1	GENERIC	150kΩ, 1%, 0805
R2, R7, R9, R11, R13, R14, R18, R19, R20, R22, R23, R27, R34	OPEN	0	-	-
R25, R26	OPEN	0	-	-
R3, R10, R12, R17, R21, R24, R30, R31	H2512-00R00-1/10W	8	GENERIC	0Ω, 1%, 0805
R32	H2512-03922-1/10W1	1	GENERIC	39.2kΩ, 1%, 0805
R4, R5, R16, R33	H2512-02003-1/10W1	4	GENERIC	200kΩ, 1%, 0805
R6	H2512-025R5-1/10W1	1	GENERIC	25.5Ω, 1%, 0805
SW1-SW5	78B03S	5	GRAYHILL	Dip Switch SPST (Raised Slide)
U1	ISL8112IRZ	1	INTERSIL	High-Efficiency, Quad Output Controller

Layout

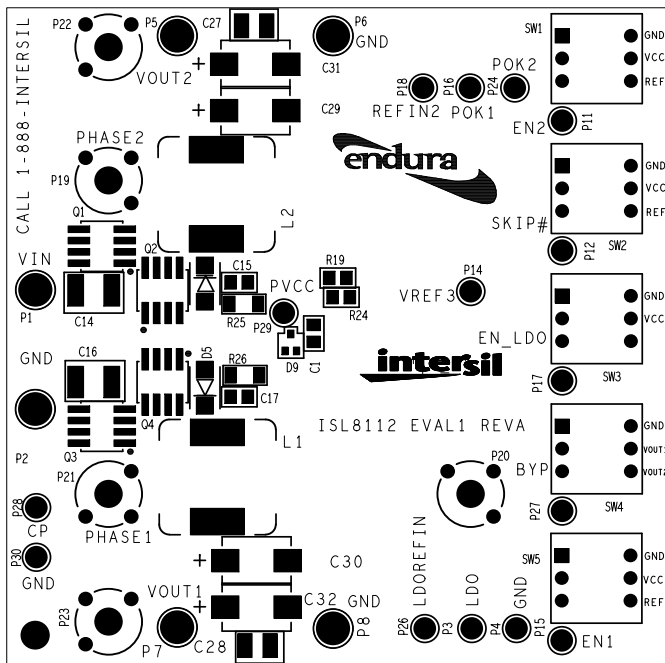

FIGURE 4. TOP COMPONENTS

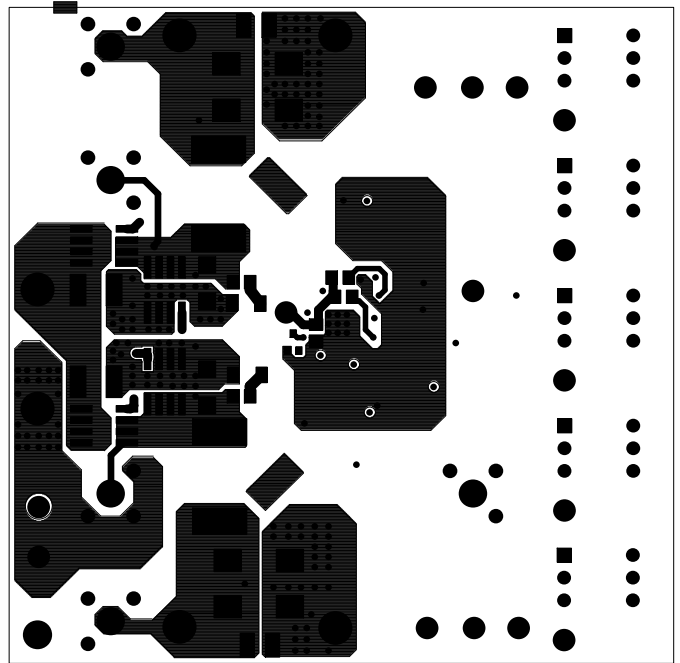

FIGURE 5. TOP ETCH

Layout (Continued)

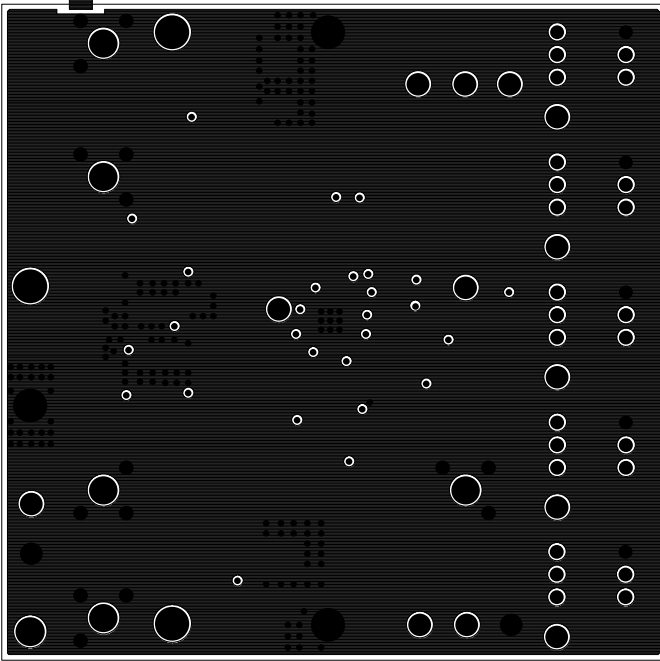

FIGURE 6. 2nd LAYER

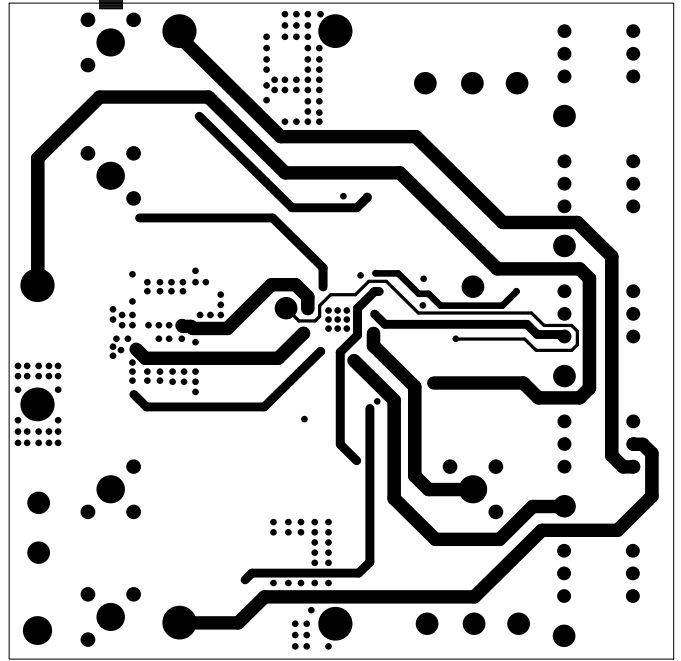

FIGURE 7. 3rd LAYER

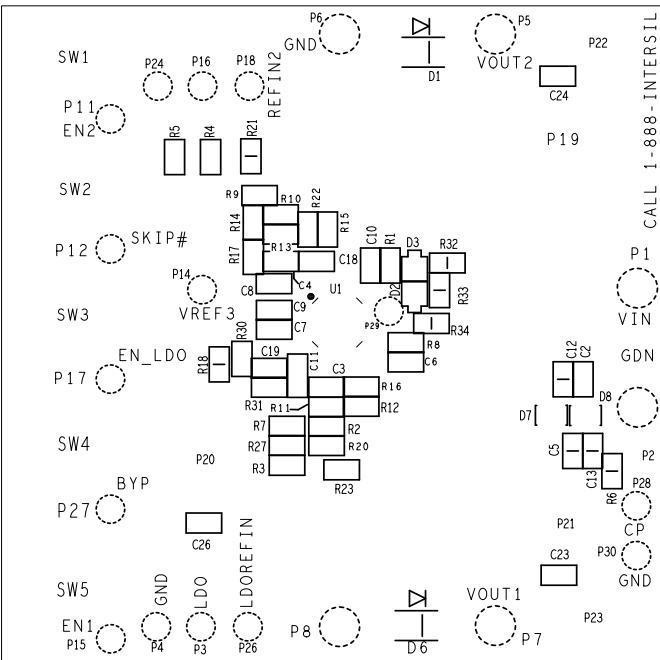

FIGURE 8. BOTTOM COMPONENTS (MIRRORED)

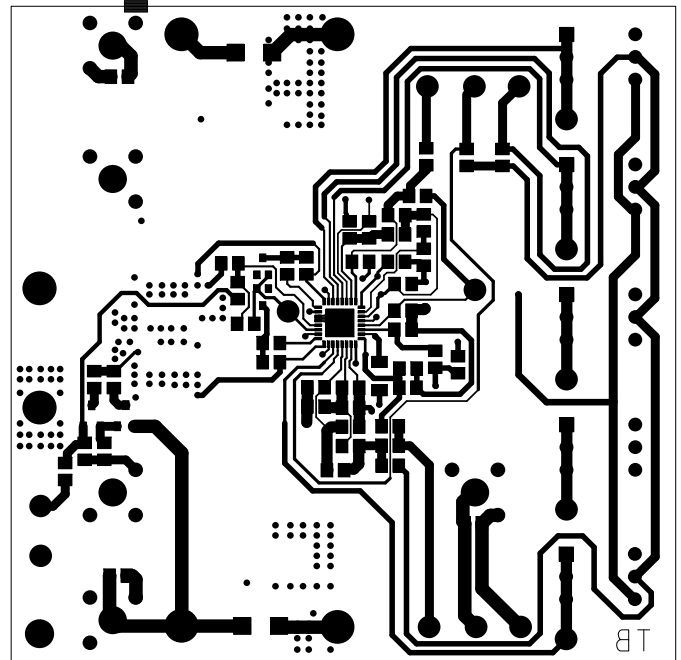

FIGURE 9. BOTTOM ETCH

Notice

1. Descriptions of circuits, software and other related information in this document are provided only to illustrate the operation of semiconductor products and application examples. You are fully responsible for the incorporation or any other use of the circuits, software, and information in the design of your product or system. Renesas Electronics disclaims any and all liability for any losses and damages incurred by you or third parties arising from the use of these circuits, software, or information.
2. Renesas Electronics hereby expressly disclaims any warranties against and liability for infringement or any other claims involving patents, copyrights, or other intellectual property rights of third parties, by or arising from the use of Renesas Electronics products or technical information described in this document, including but not limited to, the product data, drawings, charts, programs, algorithms, and application examples.
3. No license, express, implied or otherwise, is granted hereby under any patents, copyrights or other intellectual property rights of Renesas Electronics or others.
4. You shall not alter, modify, copy, or reverse engineer any Renesas Electronics product, whether in whole or in part. Renesas Electronics disclaims any and all liability for any losses or damages incurred by you or third parties arising from such alteration, modification, copying or reverse engineering.
5. Renesas Electronics products are classified according to the following two quality grades: "Standard" and "High Quality". The intended applications for each Renesas Electronics product depends on the product's quality grade, as indicated below.
"Standard": Computers; office equipment; communications equipment; test and measurement equipment; audio and visual equipment; home electronic appliances; machine tools; personal electronic equipment; industrial robots; etc.
"High Quality": Transportation equipment (automobiles, trains, ships, etc.); traffic control (traffic lights); large-scale communication equipment; key financial terminal systems; safety control equipment; etc.
Unless expressly designated as a high reliability product or a product for harsh environments in a Renesas Electronics data sheet or other Renesas Electronics document, Renesas Electronics products are not intended or authorized for use in products or systems that may pose a direct threat to human life or bodily injury (artificial life support devices or systems; surgical implantations; etc.), or may cause serious property damage (space system; undersea repeaters; nuclear power control systems; aircraft control systems; key plant systems; military equipment; etc.). Renesas Electronics disclaims any and all liability for any damages or losses incurred by you or any third parties arising from the use of any Renesas Electronics product that is inconsistent with any Renesas Electronics data sheet, user's manual or other Renesas Electronics document.
6. When using Renesas Electronics products, refer to the latest product information (data sheets, user's manuals, application notes, "General Notes for Handling and Using Semiconductor Devices" in the reliability handbook, etc.), and ensure that usage conditions are within the ranges specified by Renesas Electronics with respect to maximum ratings, operating power supply voltage range, heat dissipation characteristics, installation, etc. Renesas Electronics disclaims any and all liability for any malfunctions, failure or accident arising out of the use of Renesas Electronics products outside of such specified ranges.
7. Although Renesas Electronics endeavors to improve the quality and reliability of Renesas Electronics products, semiconductor products have specific characteristics, such as the occurrence of failure at a certain rate and malfunctions under certain use conditions. Unless designated as a high reliability product or a product for harsh environments in a Renesas Electronics data sheet or other Renesas Electronics document, Renesas Electronics products are not subject to radiation resistance design. You are responsible for implementing safety measures to guard against the possibility of bodily injury, injury or damage caused by fire, and/or danger to the public in the event of a failure or malfunction of Renesas Electronics products, such as safety design for hardware and software, including but not limited to redundancy, fire control and malfunction prevention, appropriate treatment for aging degradation or any other appropriate measures. Because the evaluation of microcomputer software alone is very difficult and impractical, you are responsible for evaluating the safety of the final products or systems manufactured by you.
8. Please contact a Renesas Electronics sales office for details as to environmental matters such as the environmental compatibility of each Renesas Electronics product. You are responsible for carefully and sufficiently investigating applicable laws and regulations that regulate the inclusion or use of controlled substances, including without limitation, the EU RoHS Directive, and using Renesas Electronics products in compliance with all these applicable laws and regulations. Renesas Electronics disclaims any and all liability for damages or losses occurring as a result of your noncompliance with applicable laws and regulations.
9. Renesas Electronics products and technologies shall not be used for or incorporated into any products or systems whose manufacture, use, or sale is prohibited under any applicable domestic or foreign laws or regulations. You shall comply with any applicable export control laws and regulations promulgated and administered by the governments of any countries asserting jurisdiction over the parties or transactions.
10. It is the responsibility of the buyer or distributor of Renesas Electronics products, or any other party who distributes, disposes of, or otherwise sells or transfers the product to a third party, to notify such third party in advance of the contents and conditions set forth in this document.
11. This document shall not be reprinted, reproduced or duplicated in any form, in whole or in part, without prior written consent of Renesas Electronics.
12. Please contact a Renesas Electronics sales office if you have any questions regarding the information contained in this document or Renesas Electronics products.
(Note 1) "Renesas Electronics" as used in this document means Renesas Electronics Corporation and also includes its directly or indirectly controlled subsidiaries.
(Note 2) "Renesas Electronics product(s)" means any product developed or manufactured by or for Renesas Electronics.

(Rev.4.0-1 November 2017)



SALES OFFICES

Renesas Electronics Corporation

<http://www.renesas.com>

Refer to "<http://www.renesas.com/>" for the latest and detailed information.

Renesas Electronics America Inc.
1001 Murphy Ranch Road, Milpitas, CA 95035, U.S.A.
Tel: +1-408-432-8888, Fax: +1-408-434-5351

Renesas Electronics Canada Limited
9251 Yonge Street, Suite 8309 Richmond Hill, Ontario Canada L4C 9T3
Tel: +1-905-237-2004

Renesas Electronics Europe Limited
Dukes Meadow, Millboard Road, Bourne End, Buckinghamshire, SL8 5FH, U.K.
Tel: +44-1628-651-700, Fax: +44-1628-651-804

Renesas Electronics Europe GmbH
Arcadiastrasse 10, 40472 Düsseldorf, Germany
Tel: +49-211-6503-0, Fax: +49-211-6503-1327

Renesas Electronics (China) Co., Ltd.
Room 1709 Quantum Plaza, No.27 ZhichunLu, Haidian District, Beijing, 100191 P. R. China
Tel: +86-10-8235-1155, Fax: +86-10-8235-7679

Renesas Electronics (Shanghai) Co., Ltd.
Unit 301, Tower A, Central Towers, 555 Langao Road, Putuo District, Shanghai, 200333 P. R. China
Tel: +86-21-2226-0888, Fax: +86-21-2226-0999

Renesas Electronics Hong Kong Limited
Unit 1601-1611, 16/F., Tower 2, Grand Century Place, 193 Prince Edward Road West, Mongkok, Kowloon, Hong Kong
Tel: +852-2265-6688, Fax: +852-2886-9022

Renesas Electronics Taiwan Co., Ltd.
13F, No. 363, Fu Shing North Road, Taipei 10543, Taiwan
Tel: +886-2-8175-9600, Fax: +886-2-8175-9670

Renesas Electronics Singapore Pte. Ltd.
80 Bendemeer Road, Unit #06-02 Hyflux Innovation Centre, Singapore 339949
Tel: +65-6213-0200, Fax: +65-6213-0300

Renesas Electronics Malaysia Sdn.Bhd.
Unit 1207, Block B, Menara Amcorp, Amcorp Trade Centre, No. 18, Jln Persiaran Barat, 46050 Petaling Jaya, Selangor Darul Ehsan, Malaysia
Tel: +60-3-7955-9390, Fax: +60-3-7955-9510

Renesas Electronics India Pvt. Ltd.
No.777C, 100 Feet Road, HAL 2nd Stage, Indiranagar, Bangalore 560 038, India
Tel: +91-80-67208700, Fax: +91-80-67208777

Renesas Electronics Korea Co., Ltd.
17F, KAMCO Yangjae Tower, 262, Gangnam-daero, Gangnam-gu, Seoul, 06265 Korea
Tel: +82-2-558-3737, Fax: +82-2-558-5338