

ISL8117ADEMO4Z

User's Manual: Buck-Boost Demo Board

Industrial Analog and Power

ISL8117ADEMO4Z

Demonstration Board

UG117
Rev.1.00
Oct 23, 2017

1. Overview

The ISL8117ADEMO4Z buck-boost demonstration board (shown in [Figures 4](#) and [5](#) on page 7) features the [ISL8117A](#) controller. The ISL8117A is a 60V high voltage synchronous buck controller that offers external soft-start and independent enable functions and integrates UV/OV/OC/OT protection. Its current mode control architecture and internal compensation network keep peripheral component count minimal. Programmable switching frequency ranging from 100kHz to 2MHz helps to optimize inductor size while the strong gate driver delivers up to 30A for the buck output.

1.1 Features

- Small, compact design
- Wide input range: 6.5V to 42V
- Programmable soft-start
- Supports prebias output with SR soft-start
- PGOOD indicator
- OCP, OVP, OTP, UVP protection

1.2 Related Literature

For a full list of related documents, visit our website

- [ISL8117A](#) product page

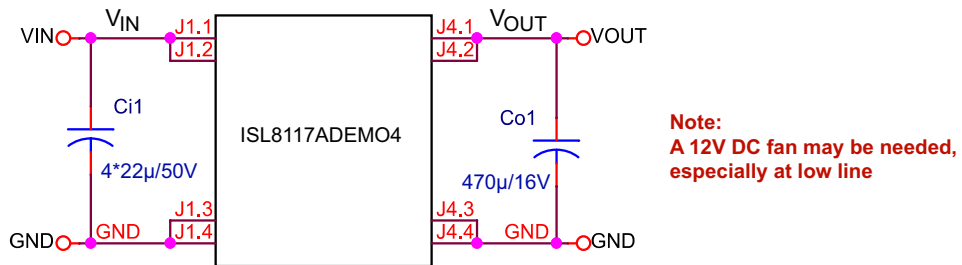

Figure 1. Typical Wiring Diagram

1.3 Specifications

The board is designed for wide input voltage applications. The current rating of it is limited by the FETs and inductor selected. The electrical ratings of the Board are shown in [Table 1](#).

Table 1. Electrical Ratings

Parameter	Rating
Input Voltage	6.5V to 42V
Switching Frequency	200kHz
Output Voltage	12V
Output Current	3A
Output Voltage Ripple	170mV _{P-P} at 3A, V _{IN} = 12V

1.4 Ordering Information

Table 2. Ordering Information

Part Number	Description
ISL8117ADEMO4Z	High voltage PWM step-up or step-down synchronous buck-boost converter

2. Testing

2.1 Recommended Testing Equipment

The following materials are recommended to perform testing:

- 0V to 42V power supply with at least 10A source current capability
- Electronic loads capable of sinking current up to 10A
- Digital Multimeters (DMMs)
- 100MHz quad-trace oscilloscope

2.2 Quick Test Guide

- (1) Ensure that the circuit is correctly connected to the supply and electronic loads before applying power. Refer to [Figure 2](#) for proper setup.
- (2) Turn on the power supply.
- (3) Adjust the input voltage V_{IN} to a value within the specified range and observe the output voltage. The output voltage variation should be within 5%.
- (4) Adjust the load current to a value within the specified range and observe the output voltage. The output voltage variation should be within 5%.
- (5) Use an oscilloscope to observe output voltage ripple and phase node ringing. For accurate measurement, refer to [Figure 3](#) for proper test setup.

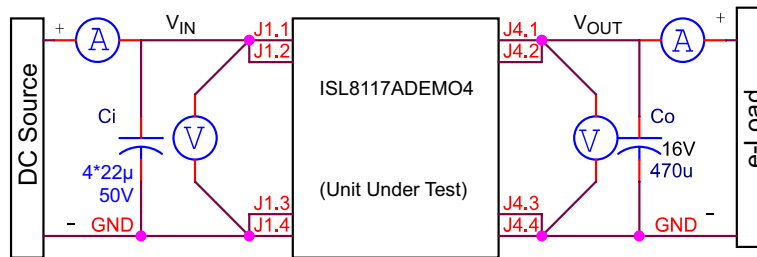

Figure 2. Proper Test Setup

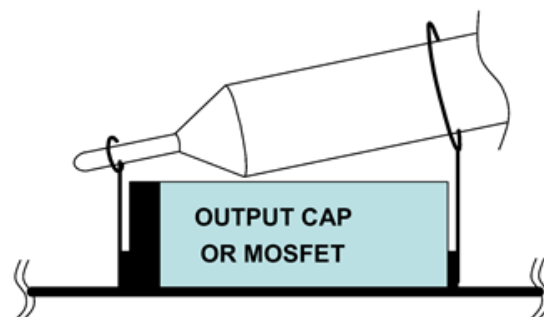

Figure 3. Proper Probe Setup to Measure Output Ripple and Phase Noise Ringing

3. Functional Description

The ISL8117ADEMO4Z buck-boost demonstration board features a compact design with high efficiency and high power density.

As shown in [Figure 2](#), 6.5V to 42V V_{IN} is supplied to J1.1 (+) and J1.3 (-). The regulated 12V output on J4.1 (+) and J4.3 (-) can supply up to 3A to the load.

3.1 Operating Range

The input voltage range is from 6.5V to 42V for an output voltage of 12V. The rated load current is 3A with the OCP point set at a minimum of 5A at room temperature ambient conditions.

The temperature operating range of the ISL8117A is -40°C to +125°C. Airflow is needed for higher temperature ambient conditions. For example, when $V_{IN} = 36V$, a 12VDC fan is needed.

3.2 Evaluating the Other Output Voltages

The output is preset to 12V, however, it can be adjusted. The output voltage programming resistor, R_2 , will depend on the desired output voltage of the regulator and the value of the feedback resistor, R_1 , as shown in [\(EQ. 1\)](#).

$$R_2 = R_1 \left(\frac{0.6V}{V_{OUT} - 0.6V} \right) \quad (\text{EQ. 1})$$

4. PCB Layout Guidelines

Careful attention to layout requirements is necessary for successful implementation of an ISL8117ADEMO4Z based DC/DC converter. The ISL8117A switches at a high frequency and therefore, the switching times are very short. At these switching frequencies, even the shortest trace has significant impedance.

Also, the peak gate drive current rises significantly in an extremely short time. Transition speed of the current from one device to another causes voltage spikes across the interconnecting impedances and parasitic circuit elements.

These voltage spikes can degrade efficiency, generate EMI, and increase device overvoltage stress and ringing. Careful component selection and proper PC board layout minimizes the magnitude of these voltage spikes.

There are three sets of critical components in a DC/DC converter using the ISL8117A:

- The controller
- The switching power components
- The small signal components

The switching power components are the most critical from a layout point of view because they switch a large amount of energy, which tends to generate a large amount of noise. The critical small signal components are those connected to sensitive nodes or those supplying critical bias currents. A multilayer printed circuit board is recommended.

4.1 Layout Considerations

- (1) The input capacitors, upper FET, lower FET, and inductor and output capacitors should be placed first. Isolate these power components on dedicated areas of the board with their ground terminals adjacent to one another. Place the input high frequency decoupling ceramic capacitors very close to the MOSFETs.
- (2) If signal components and the IC are placed in a separate area to the power train, it is recommended to use full ground planes in the internal layers with shared SGND and PGND to simplify the layout design. Otherwise, use separate ground planes for power ground and small signal ground. Connect the SGND and PGND together close to the IC. DO NOT connect them together anywhere else.
- (3) The loop formed by the input capacitor to the FET must be kept as small as possible.
- (4) Ensure the current paths from the input capacitor to the MOSFET, the output inductor, and the output capacitor are as short as possible with maximum allowable trace widths.
- (5) Place the PWM controller IC close to the lower FET. The LGATE connection should be short and wide. The IC is best placed over a quiet ground area. Avoid switching ground loop currents in this area.
- (6) Place the VCC5V bypass capacitor very close to the VCC5V pin of the IC and connect its ground to the PGND plane.
- (7) Place the gate drive components (optional BOOT diode and BOOT capacitors) together near the controller IC.
- (8) The output capacitors should be placed as close to the load as possible. Use short, wide copper regions to connect output capacitors to load to avoid inductance and resistances.
- (9) Use copper filled polygons or wide but short traces to connect the junction of the FET and output inductor. Also keep the PHASE node connection to the IC short. DO NOT unnecessarily oversize the copper islands for the PHASE node. Since the phase nodes are subjected to very high dv/dt voltages, the stray capacitor formed between these islands and the surrounding circuitry will tend to couple switching noise.
- (10) Route all high-speed switching nodes away from the control circuitry.
- (11) Create a separate small analog ground plane near the IC. Connect the SGND pin to this plane. All small signal grounding paths including feedback resistors, current limit setting resistor, soft-starting capacitor, and EN pull-down resistor should be connected to this SGND plane.
- (12) Separate the current-sensing trace from the PHASE node connection.
- (13) Ensure the feedback connection to the output capacitor is short and direct.
- (14) Properly use via array and copper to improve the heat dissipating capacity of the PCB.

4.2 ISL8117A-DEMO4Z Buck-Boost Board

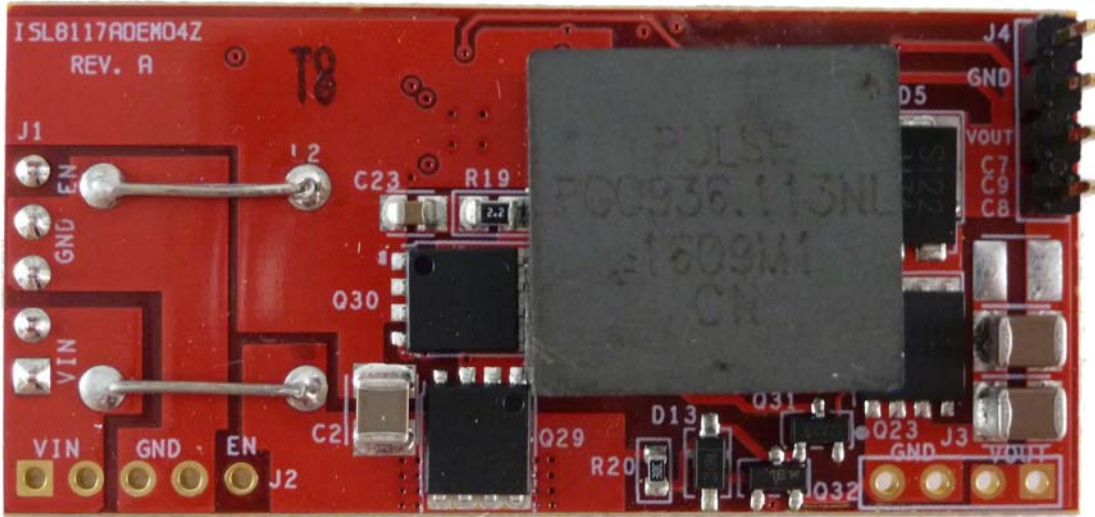

Figure 4. Top View

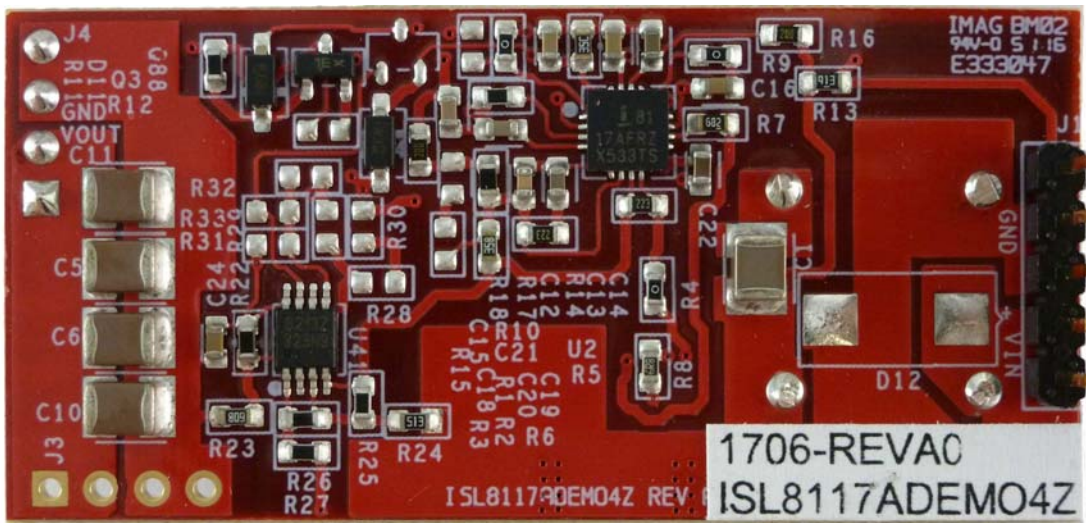

Figure 5. Bottom View

4.3 Schematic

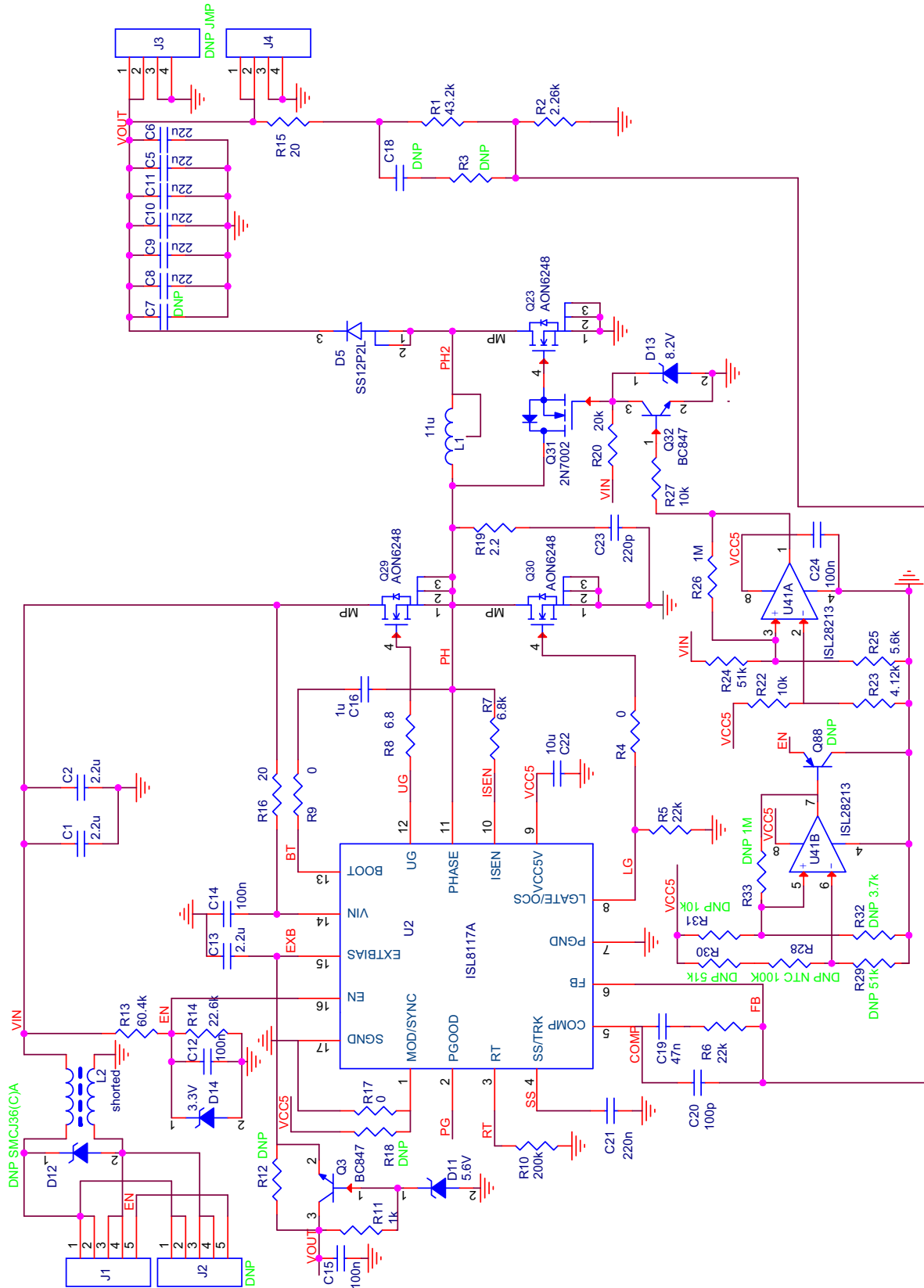

Figure 6. ISL8117ADEMO4Z Schematic

4.4 Bill of Materials

Table 3. ISL8117ADEMO4Z Bill of Materials

Qty	Reference Designator	Description	Manufacturer	Manufacturer Part
1	C20	CAP, SM0603, 100pF, 50V, 10%, X7R	KEMET	C0603C101K5RACTU
1	C14	CAP, SM0603, 0.1µF, 100V, 10%, X7R	VENKEL	C0603X7R101-104KNE
2	C12, C15	CAP, SM0603, 0.1µF, 16V, 10%, X7R	MURATA	GRM39X7R104K016AD
1	C24	CAP, SM0603, 0.1µF, 50V, 10%, X7R	AVX	06035C104KAT2A
1	C16	CAP, SM0603, 1µF, 25V, 10%, X5R	MURATA	GRM188R61E105KA12D
1	C22	CAP, SM0603, 10µF, 16V, 10%, X5R	MURATA	GRM188R61C106KAALD
1	C21	CAP, SM0603, 0.22µF, 25V, 10%, X7R	TDK	C1608X7R1E224K
1	C13	CAP, SM0603, 2.2µF, 16V, 10%, X5R	MURATA	GRM188R61C225KE15D
1	C19	CAP, SM0603, .047µF, 50V, 10%, X7R	PANASONIC	ECJ-1VB1H473K
1	C23	CAP, SM0805, 220pF, 100V, 10%, X7R	AVX	08051C221KAT2A
2	C1, C2	CAP, SM1210, 2.2µF, 100V, 10%, X7R	MURATA	GRM32ER72A225KA35L
6	C5, C6, C8~11	CAP, SM1210, 22µF, 16V, 10%, X7R	MURATA	GRM32ER71C226KE18L
1	L1	COIL-PWR INDUCT, SM17.5x16.7, 11µH, 20%, 14A	PULSE	PG0936.113NL
	L1 *(ALT)	COIL-PWR INDUCT, SM17.5x16.7, 11µH, 20%, 14A	ValueStar	VSCC1710-110M
1	J4	CONN-HEADER, 1x4, BRKAWY 1x36, 2.54mm	BERG/FCI	68000-236HLF
1	J1	CONN-HEADER, 1x5, BRKAWY 1x36, 2.54mm	BERG/FCI	68000-236HLF
1	D14	DIODE-ZENER, SM2P, SOD-123, 3.3V, 500mW	DIODES, INC.	BZT52C3V3-7-F
1	D11	DIODE-ZENER, SMSOD-123, 500mW, 5.6V, PbFREE	DIODES, INC.	BZT52C5V6-7-F
1	D13	DIODE-ZENER, SM2P, SOD-123, 8.2V, 500mW	DIODES, INC.	BZT52C8V2-7-F
1	D5	DIODE-SCHOTTKY RECTIFIER, SMTO277A, 20V, 12A	VISHAY	SS12P2L-M3/86A
1	U41	IC-DUAL OP AMP, RRIO, 8P, MSOP	INTERSIL	ISL28213FUZ
1	U2	IC-55V SWITCHING CONTROLLER, 16P, QFN	INTERSIL	ISL8117AFRZ
1	Q31	TRANSISTOR, N-CHANNEL, 3LD, SOT-23, 60V, 115mA	DIODES, INC.	2N7002-7-F
3	Q23, Q29, Q30	TRANSISTOR-MOS, N-CHANNEL, 60V, 17.5A, 8P, DFN, 5x6	ALPHA & OMEGA SEMICONDUCTOR	AON6248
2	Q3, Q32	TRANSISTOR, NPN, SM3P, SOT-23, 45V, 100mA	ON SEMICONDUCTOR	BC847ALT1G
2	R15, R16	RES, SM0603, 20, 1/10W, 1%, TF	PANASONIC	ERJ-3EKF20R0V
1	R8	RES, SM0603, 6.8Ω, 1/10W, 1%, TF	VENKEL	CR0603-10W-6R80FT
3	R4, R9, R17	RES, SM0603, 0Ω, 1/10W, TF	VENKEL	CR0603-10W-000T
1	R11	RES, SM0603, 1k, 1/10W, 1%, TF	PANASONIC	ERJ-3EKF1001V
2	R22, R27	RES, SM0603, 10k, 1/10W, 1%, TF	VENKEL	CR0603-10W-1002FT
1	R26	RES, SM0603, 1M, 1/10W, 1%, TF	PANASONIC	ERJ-3EKF1004V
1	R20	RES, SM0603, 20k, 1/10W, 1%, TF	VENKEL	CR0603-10W-2002FT
1	R10	RES, SM0603, 200k, 1/10W, 1%, TF	VENKEL	CR0603-10W-2003FT
2	R5, R6	RES, SM0603, 22k, 1/10W, 1%, TF	VENKEL	CR0603-10W-2202FT
1	R2	RES, SM0603, 2.26k, 1/10W, 1%, TF	YAGEO	RC0603FR-072K26L
1	R14	RES, SM0603, 22.6k, 1/10W, 1%, TF	VENKEL	CR0603-10W-2262FT
1	R23	RES, SM0603, 4.12k, 1/10W, 1%, TF	PANASONIC	ERJ-3EKF4121V

Table 3. ISL8117ADEMO4Z Bill of Materials (Continued)

Qty	Reference Designator	Description	Manufacturer	Manufacturer Part
1	R1	RES, SM0603, 43.2k, 1/10W, 1%, TF	YAGEO	RC0603FR-0743K2L(PbFREE)
1	R24	RES, SM0603, 51k, 1/10W, 1%, TF	YAGEO	RC0603FR-0751KL
1	R25	RES, SM0603, 5.6k, 1/10W, 1%, TF	PANASONIC	ERJ-3EKF5601V
1	R7	RES, SM0603, 6.8k, 1/10W, 1%, TF	YAGEO	RC0603FR-076K8L
1	R13	RES, SM0603, 60.4k, 1/10W, 1%, TF	PANASONIC	ERJ-3EKF6042V
1	R19	RES, SM0805, 2.2Ω, 1/8W, 1%, TF	PANASONIC	ERJ-6RQF2R2V
1	L2	0μH (WIRE, 22AWG, SOLID, BUS COPPER JUMPER)		
0	R3, R12, R18, R28~33, C7, C18, D12, J2, J3, Q88	DO NOT POPULATE OR PURCHASE		

4.5 PCB Layout

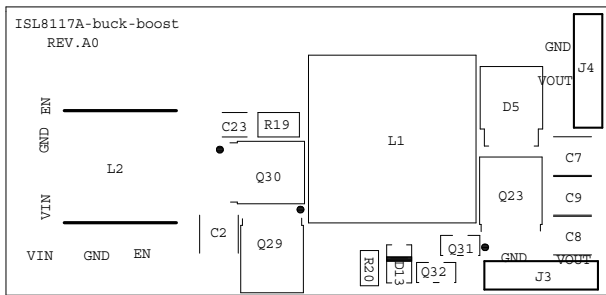

Figure 7. Assembly Top



Figure 8. Layer 1 - Top

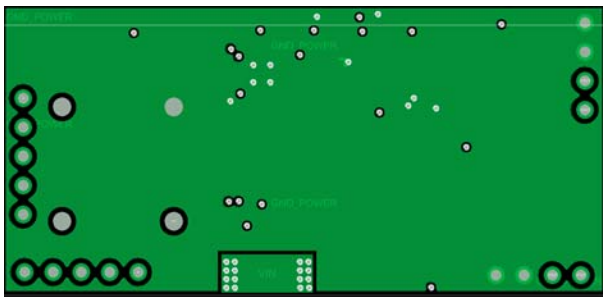

Figure 9. Layer 2 (Solid Ground)

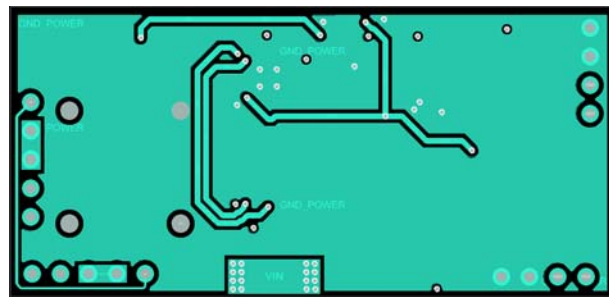

Figure 10. Layer 3

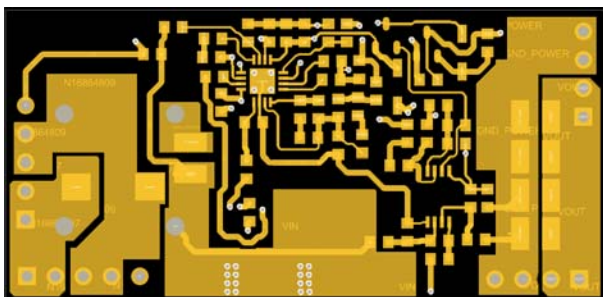

Figure 11. Layer 4 - Bottom

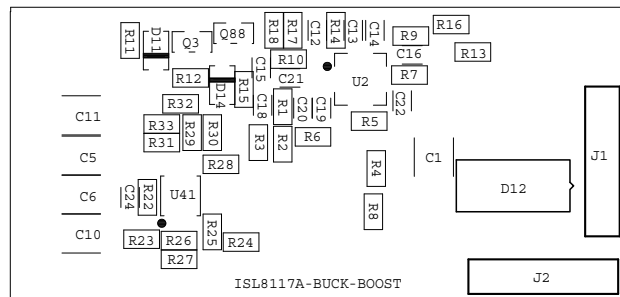

Figure 12. Assembly - Bottom

5. Typical Evaluation Board Performance Curves

$V_{IN} = 24V$, $V_{OUT} = 12V$, unless otherwise noted.

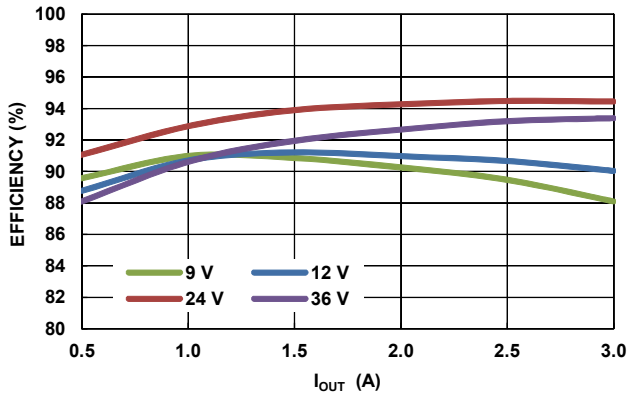

Figure 13. Efficiency

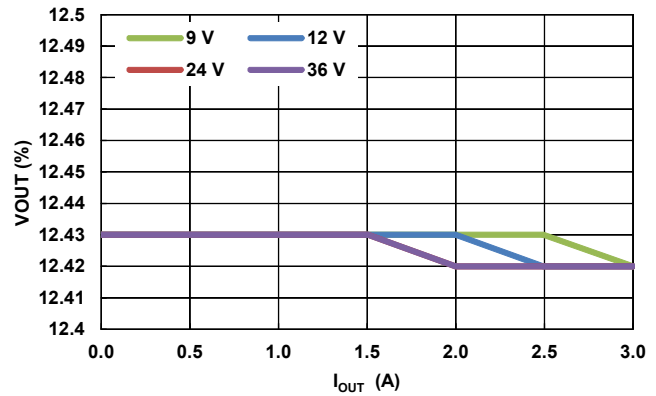

Figure 14. Load Regulation

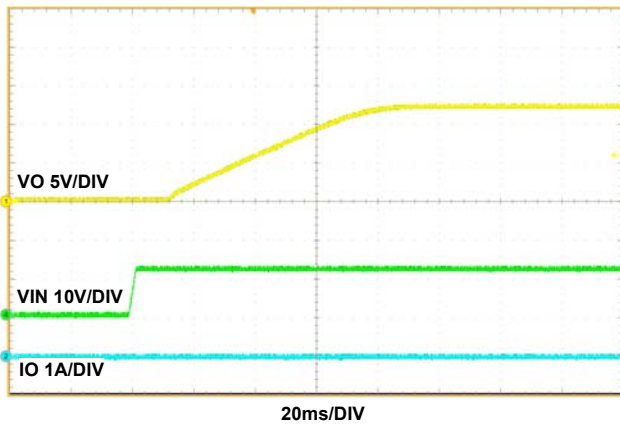

Figure 15. Start-Up Waveforms ($V_{IN} = 12V$, $I_{OUT} = 0A$)

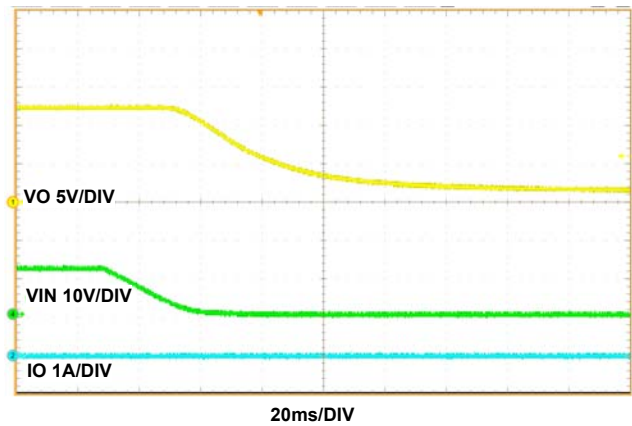

Figure 16. Shutdown Waveforms ($V_{IN} = 12V$, $I_{OUT} = 0A$)

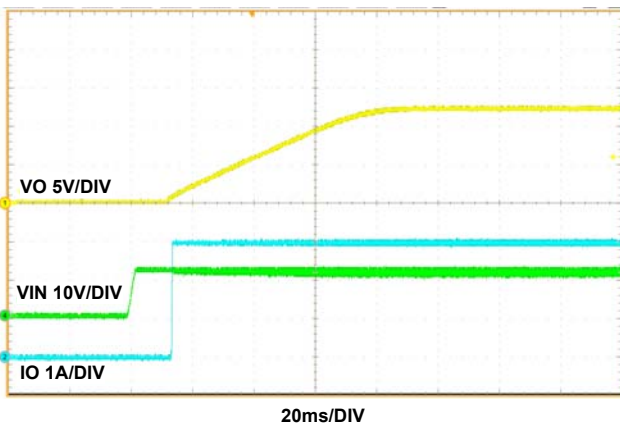

Figure 17. Start-Up Waveforms ($V_{IN} = 12V$, $I_{OUT} = 3A$)

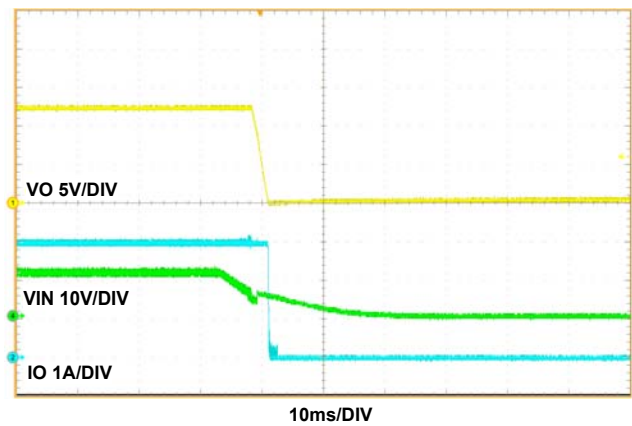

Figure 18. Shutdown Waveforms ($V_{IN} = 12V$, $I_{OUT} = 3A$)

$V_{IN} = 24V$, $V_{OUT} = 12V$, unless otherwise noted. (Continued)

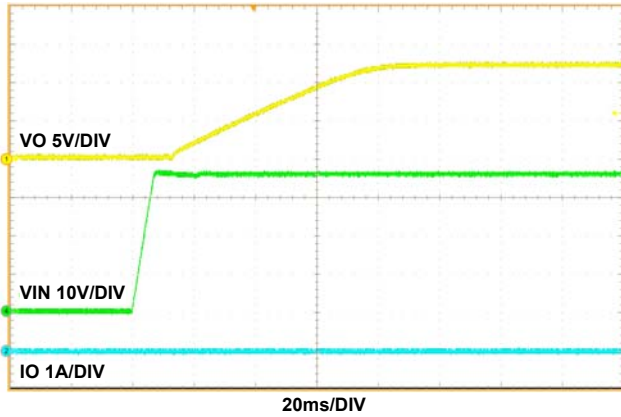

Figure 19. Start-Up Waveforms
($V_{IN} = 36V$, $I_{OUT} = 0A$)

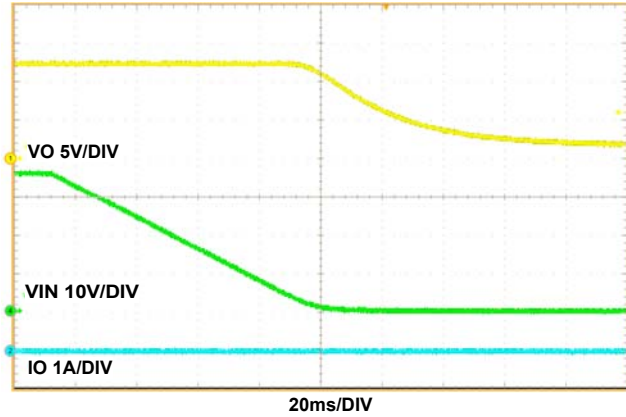

Figure 20. Shutdown Waveforms
($V_{IN} = 36V$, $I_{OUT} = 0A$)

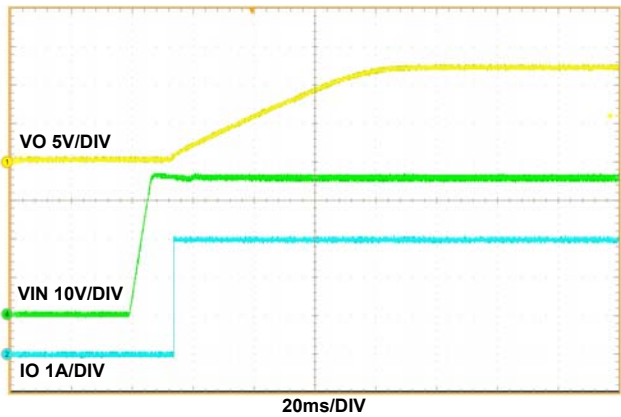

Figure 21. Start-Up Waveforms
($V_{IN} = 36V$, $I_{OUT} = 3A$)

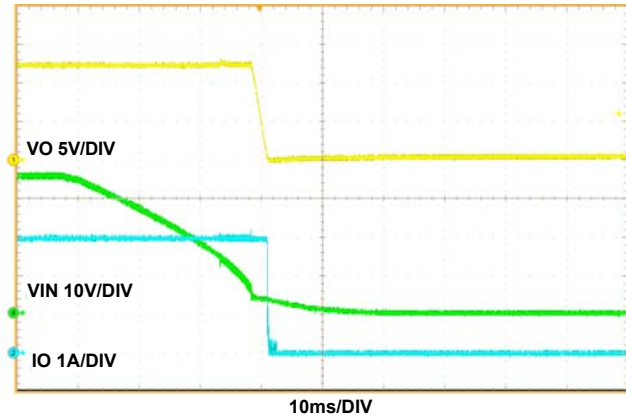

Figure 22. Shutdown Waveforms
($V_{IN} = 36V$, $I_{OUT} = 3A$)

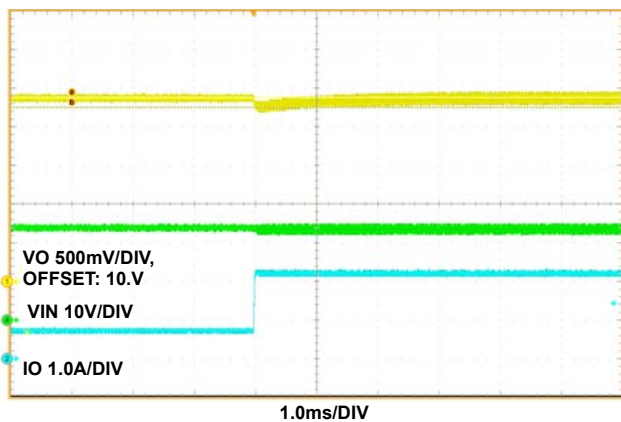

Figure 23. Load Transient,
($I_{OUT} = 0.75$ to $2.25A$)

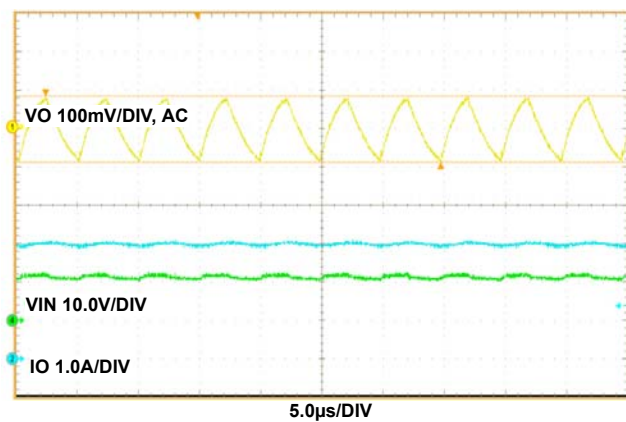

Figure 24. Output Ripple
($I_{OUT} = 3A$, $V_{IN} = 12V$)

$V_{IN} = 24V$, $V_{OUT} = 12V$, unless otherwise noted. (Continued)

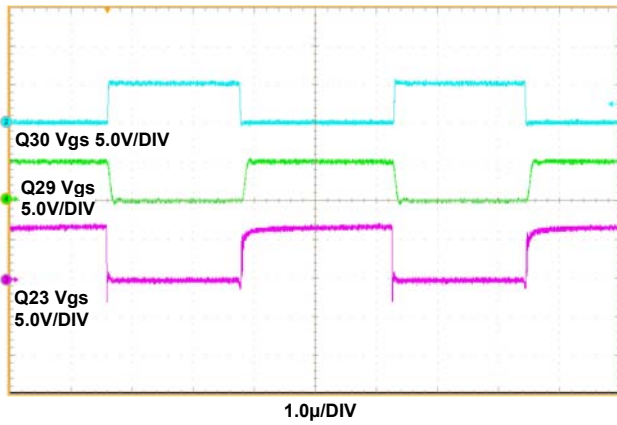

Figure 25. Gating Signals
 $V_{IN} = 12V$, $I_{OUT} = 3A$

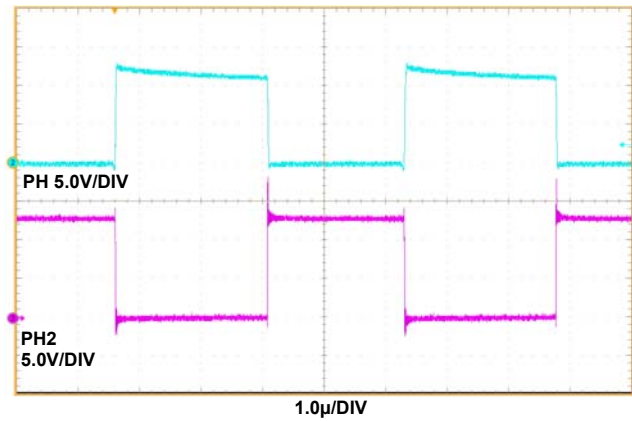

Figure 26. PH and PH2 Waveforms,
 $V_{IN} = 12V$, $I_{OUT} = 3A$

6. Revision History

Rev.	Date	Description
1.00	Oct 23, 2017	In Figure 1 on page 2 , changed from “47u/100V” to “4*22u/50V” and added a note, “A 12V DC fan may be needed, especially at low line”. In Figure 2 on page 4 , changed from “47u/100V” to “4*22u/50V”. In Figure 6 on page 8 , changed R13 from “91k” to “60.4k”. In Table 3 on page 9 , changed R13 from “91k” to “60.4k” and the part number from “ERJ-3EKF9102V” to “ERJ-3EKF6042V”.
0.00	Apr 28, 2017	Initial release

© Copyright Intersil Americas LLC 2017. All Rights Reserved.

All trademarks and registered trademarks are the property of their respective owners.

Intersil Corporation reserves the right to make changes in circuit design, software and/or specifications at any time without notice. Accordingly, the reader is cautioned to verify that the document is current before proceeding.

For information regarding Intersil Corporation and its products, see www.intersil.com

ISL8117ADEMO4Z

