

# RL78 Family

RTK7RLG240P00000BJ  
RL78/G24 DC/DC LED Control Evaluation Board  
User's Manual

All information contained in these materials, including products and product specifications, represents information on the product at the time of publication and is subject to change by Renesas Electronics Corp. without notice. Please review the latest information published by Renesas Electronics Corp. through various means, including the Renesas Electronics Corp. website (<http://www.renesas.com>).

## Notice

1. Descriptions of circuits, software and other related information in this document are provided only to illustrate the operation of semiconductor products and application examples. You are fully responsible for the incorporation or any other use of the circuits, software, and information in the design of your product or system. Renesas Electronics disclaims any and all liability for any losses and damages incurred by you or third parties arising from the use of these circuits, software, or information.
2. Renesas Electronics hereby expressly disclaims any warranties against and liability for infringement or any other claims involving patents, copyrights, or other intellectual property rights of third parties, by or arising from the use of Renesas Electronics products or technical information described in this document, including but not limited to, the product data, drawings, charts, programs, algorithms, and application examples.
3. No license, express, implied or otherwise, is granted hereby under any patents, copyrights or other intellectual property rights of Renesas Electronics or others.
4. You shall be responsible for determining what licenses are required from any third parties, and obtaining such licenses for the lawful import, export, manufacture, sales, utilization, distribution or other disposal of any products incorporating Renesas Electronics products, if required.
5. You shall not alter, modify, copy, or reverse engineer any Renesas Electronics product, whether in whole or in part. Renesas Electronics disclaims any and all liability for any losses or damages incurred by you or third parties arising from such alteration, modification, copying or reverse engineering.
6. Renesas Electronics products are classified according to the following two quality grades: "Standard" and "High Quality". The intended applications for each Renesas Electronics product depends on the product's quality grade, as indicated below.

"Standard": Computers; office equipment; communications equipment; test and measurement equipment; audio and visual equipment; home electronic appliances; machine tools; personal electronic equipment; industrial robots; etc.

"High Quality": Transportation equipment (automobiles, trains, ships, etc.); traffic control (traffic lights); large-scale communication equipment; key financial terminal systems; safety control equipment; etc.

Unless expressly designated as a high reliability product or a product for harsh environments in a Renesas Electronics data sheet or other Renesas Electronics document, Renesas Electronics products are not intended or authorized for use in products or systems that may pose a direct threat to human life or bodily injury (artificial life support devices or systems; surgical implantations; etc.), or may cause serious property damage (space system; undersea repeaters; nuclear power control systems; aircraft control systems; key plant systems; military equipment; etc.). Renesas Electronics disclaims any and all liability for any damages or losses incurred by you or any third parties arising from the use of any Renesas Electronics product that is inconsistent with any Renesas Electronics data sheet, user's manual or other Renesas Electronics document.

7. No semiconductor product is absolutely secure. Notwithstanding any security measures or features that may be implemented in Renesas Electronics hardware or software products, Renesas Electronics shall have absolutely no liability arising out of any vulnerability or security breach, including but not limited to any unauthorized access to or use of a Renesas Electronics product or a system that uses a Renesas Electronics product. RENESAS ELECTRONICS DOES NOT WARRANT OR GUARANTEE THAT RENESAS ELECTRONICS PRODUCTS, OR ANY SYSTEMS CREATED USING RENESAS ELECTRONICS PRODUCTS WILL BE INVULNERABLE OR FREE FROM CORRUPTION, ATTACK, VIRUSES, INTERFERENCE, HACKING, DATA LOSS OR THEFT, OR OTHER SECURITY INTRUSION ("Vulnerability Issues"). RENESAS ELECTRONICS DISCLAIMS ANY AND ALL RESPONSIBILITY OR LIABILITY ARISING FROM OR RELATED TO ANY VULNERABILITY ISSUES. FURTHERMORE, TO THE EXTENT PERMITTED BY APPLICABLE LAW, RENESAS ELECTRONICS DISCLAIMS ANY AND ALL WARRANTIES, EXPRESS OR IMPLIED, WITH RESPECT TO THIS DOCUMENT AND ANY RELATED OR ACCOMPANYING SOFTWARE OR HARDWARE, INCLUDING BUT NOT LIMITED TO THE IMPLIED WARRANTIES OF MERCHANTABILITY, OR FITNESS FOR A PARTICULAR PURPOSE.
8. When using Renesas Electronics products, refer to the latest product information (data sheets, user's manuals, application notes, "General Notes for Handling and Using Semiconductor Devices" in the reliability handbook, etc.), and ensure that usage conditions are within the ranges specified by Renesas Electronics with respect to maximum ratings, operating power supply voltage range, heat dissipation characteristics, installation, etc. Renesas Electronics disclaims any and all liability for any malfunctions, failure or accident arising out of the use of Renesas Electronics products outside of such specified ranges.
9. Although Renesas Electronics endeavors to improve the quality and reliability of Renesas Electronics products, semiconductor products have specific characteristics, such as the occurrence of failure at a certain rate and malfunctions under certain use conditions. Unless designated as a high reliability product or a product for harsh environments in a Renesas Electronics data sheet or other Renesas Electronics document, Renesas Electronics products are not subject to radiation resistance design. You are responsible for implementing safety measures to guard against the possibility of bodily injury, injury or damage caused by fire, and/or danger to the public in the event of a failure or malfunction of Renesas Electronics products, such as safety design for hardware and software, including but not limited to redundancy, fire control and malfunction prevention, appropriate treatment for aging degradation or any other appropriate measures. Because the evaluation of microcomputer software alone is very difficult and impractical, you are responsible for evaluating the safety of the final products or systems manufactured by you.
10. Please contact a Renesas Electronics sales office for details as to environmental matters such as the environmental compatibility of each Renesas Electronics product. You are responsible for carefully and sufficiently investigating applicable laws and regulations that regulate the inclusion or use of controlled substances, including without limitation, the EU RoHS Directive, and using Renesas Electronics products in compliance with all these applicable laws and regulations. Renesas Electronics disclaims any and all liability for damages or losses occurring as a result of your noncompliance with applicable laws and regulations.
11. Renesas Electronics products and technologies shall not be used for or incorporated into any products or systems whose manufacture, use, or sale is prohibited under any applicable domestic or foreign laws or regulations. You shall comply with any applicable export control laws and regulations promulgated and administered by the governments of any countries asserting jurisdiction over the parties or transactions.
12. It is the responsibility of the buyer or distributor of Renesas Electronics products, or any other party who distributes, disposes of, or otherwise sells or transfers the product to a third party, to notify such third party in advance of the contents and conditions set forth in this document.
13. This document shall not be reprinted, reproduced or duplicated in any form, in whole or in part, without prior written consent of Renesas Electronics.
14. Please contact a Renesas Electronics sales office if you have any questions regarding the information contained in this document or Renesas Electronics products.

(Note1) "Renesas Electronics" as used in this document means Renesas Electronics Corporation and also includes its directly or indirectly controlled subsidiaries.

(Note2) "Renesas Electronics product(s)" means any product developed or manufactured by or for Renesas Electronics.

(Rev.5.0-1 October 2020)

## Corporate Headquarters

TOYOSU FORESIA, 3-2-24 Toyosu,

Koto-ku, Tokyo 135-0061, Japan

[www.renesas.com](http://www.renesas.com)

## Trademarks

Renesas and the Renesas logo are trademarks of Renesas Electronics Corporation. All trademarks and registered trademarks are the property of their respective owners.

## Contact information

For further information on a product, technology, the most up-to-date version of a document, or your nearest sales office, please visit:

[www.renesas.com/contact/](http://www.renesas.com/contact/).

## General Precautions in the Handling of Microprocessing Unit and Microcontroller Unit Products

The following usage notes are applicable to all Microprocessing unit and Microcontroller unit products from Renesas. For detailed usage notes on the products covered by this document, refer to the relevant sections of the document as well as any technical updates that have been issued for the products.

### 1. Precaution against Electrostatic Discharge (ESD)

A strong electrical field, when exposed to a CMOS device, can cause destruction of the gate oxide and ultimately degrade the device operation. Steps must be taken to stop the generation of static electricity as much as possible, and quickly dissipate it when it occurs. Environmental control must be adequate. When it is dry, a humidifier should be used. This is recommended to avoid using insulators that can easily build up static electricity.

Semiconductor devices must be stored and transported in an anti-static container, static shielding bag or conductive material. All test and measurement tools including work benches and floors must be grounded. The operator must also be grounded using a wrist strap. Semiconductor devices must not be touched with bare hands. Similar precautions must be taken for printed circuit boards with mounted semiconductor devices.

### 2. Processing at power-on

The state of the product is undefined at the time when power is supplied. The states of internal circuits in the LSI are indeterminate and the states of register settings and pins are undefined at the time when power is supplied. In a finished product where the reset signal is applied to the external reset pin, the states of pins are not guaranteed from the time when power is supplied until the reset process is completed. In a similar way, the states of pins in a product that is reset by an on-chip power-on reset function are not guaranteed from the time when power is supplied until the power reaches the level at which resetting is specified.

### 3. Input of signal during power-off state

Do not input signals or an I/O pull-up power supply while the device is powered off. The current injection that results from input of such a signal or I/O pull-up power supply may cause malfunction and the abnormal current that passes in the device at this time may cause degradation of internal elements. Follow the guideline for input signal during power-off state as described in your product documentation.

### 4. Handling of unused pins

Handle unused pins in accordance with the directions given under handling of unused pins in the manual. The input pins of CMOS products are generally in the high-impedance state. In operation with an unused pin in the open-circuit state, extra electromagnetic noise is induced in the vicinity of the LSI, an associated shoot-through current flows internally, and malfunctions occur due to the false recognition of the pin state as an input signal become possible.

### 5. Clock signals

After applying a reset, only release the reset line after the operating clock signal becomes stable. When switching the clock signal during program execution, wait until the target clock signal is stabilized. When the clock signal is generated with an external resonator or from an external oscillator during a reset, ensure that the reset line is only released after full stabilization of the clock signal. Additionally, when switching to a clock signal produced with an external resonator or by an external oscillator while program execution is in progress, wait until the target clock signal is stable.

### 6. Voltage application waveform at input pin

Waveform distortion due to input noise or a reflected wave may cause malfunction. If the input of the CMOS device stays in the area between  $V_{IL}$  (Max.) and  $V_{IH}$  (Min.) due to noise, for example, the device may malfunction. Take care to prevent chattering noise from entering the device when the input level is fixed, and also in the transition period when the input level passes through the area between  $V_{IL}$  (Max.) and  $V_{IH}$  (Min.).

### 7. Prohibition of access to reserved addresses

Access to reserved addresses is prohibited. The reserved addresses are provided for possible future expansion of functions. Do not access these addresses as the correct operation of the LSI is not guaranteed.

### 8. Differences between products

Before changing from one product to another, for example to a product with a different part number, confirm that the change will not lead to problems.

The characteristics of a microprocessing unit or microcontroller unit products in the same group but having a different part number might differ in terms of internal memory capacity, layout pattern, and other factors, which can affect the ranges of electrical characteristics, such as characteristic values, operating margins, immunity to noise, and amount of radiated noise. When changing to a product with a different part number, implement a system-evaluation test for the given product.

# How to Use This Manual

## 1. Purpose and Target Readers

This manual is intended for users who want to develop Lighting systems or Digital power supply systems with RL78/G24 microcontrollers.



Basic knowledge of electrical circuits, logic circuits, and microcomputers is required to use this manual. This manual is broadly categorized and consists of product overview, specifications, and usage instructions.

Particular attention should be paid to the precautionary notes when using the manual. These notes occur within the body of the text, at the end of each section, and in the Usage Notes section.







The revision history summarizes the locations of revisions and additions. It does not list all revisions. Refer to the text of the manual for details.

## 2. Symbols Used



This document uses the following symbols for items to be observed to ensure the safe use of the unit. The symbols are followed by a brief explanation of the possible extent of problems which may occur if the items are not observed.

	<b>Danger</b>	The risk is high if the warning is not observed, and the user may suffer death or serious injury.
	<b>Warning</b>	The user may suffer death or serious injury if the warning is not observed.
	<b>Caution</b>	Human injury or property damage may occur if the caution is not observed.











The following symbols express behaviors that are prohibited in order to prevent injury or accident.

	<b>General prohibition</b> The action mentioned is prohibited.		<b>Do not touch</b> Touching the specified location may cause injury.		<b>Do not disassemble.</b> Disassembly may cause a problem such as electric shock or product failure.
	<b>Keep away from water</b> Use near water poses the risk of electric shock or product failure if moisture were to contact the unit.		<b>Flammable</b> Proximity to flame may cause the unit to catch fire.		<b>Do not touch with wet hands</b> Touching with wet hands may cause electric shock or product failure.

The following symbols are used for cautions to prevent product failure and accidents.

	<b>General caution</b> Unspecified general cautions		<b>Caution: Hot</b> Human injury due to a high temperature
---	--	---	---

## Warnings

 <h1 style="margin: 0;">Warning</h1>	
	<p><b>Be careful to avoid burns.</b> The temperature of this part of board increases when AC power is connected.</p>
	<p><b>Be careful of LED brightness and the LED On/Off interval.</b> Simulations of strong light may cause symptoms linked to an epileptic condition.</p>
	<p><b>Do not use this board for a purpose other than the evaluation of an MCU.</b> This board does not include the safety measures or anti-EMI measures required for lighting equipment.</p>
	<p><b>Do not heat the board or expose it to fire and do not short the terminals.</b> Doing so may cause the product to fail, heat up, catch fire, or rupture.</p>
	<p><b>Do not disassemble or modify the board.</b> Doing so may cause the product to fail, emit smoke, or catch fire, or result in electric shock.</p>
	<p><b>Do not touch with wet hands.</b> Doing so while connected to power may cause the product to fail or result in electric shock.</p>
	<p><b>Do not look directly at the LEDs on this board.</b> Doing so may weaken eyesight.</p>
	<p><b>Do not drop the board or subject the board to heavy impact.</b> Doing so may break or damage the board, causing fire or electric shock.</p>
	<p><b>Do not turn on the power switch when the AC adapter, interface cable, or other cables are not properly connected.</b> Doing so may cause the product to fail, heat up, or catch fire, or result in electric shock.</p>
	<p><b>Do not plug in or unplug a connector or cable with power applied to the board.</b> Doing so may cause the product to fail, heat up, or catch fire, or result in electric shock.</p>
	<p><b>Do not move this board when the AC adapter or any cables are connected.</b> Doing so may damage cables and cause the product to fail, heat up, or catch fire, or result in electric shock.</p>
	<p><b>Use this board with a spacer and on an electrically isolated bench.</b> If a conductor contacts the board, the product may fail, heat up, or catch fire, or it may result in electric shock.</p>
	<p><b>Use an AC adapter adapted to the safety standard of each country.</b> Using an inappropriate AC adapter may cause the product to fail, heat up, or catch fire, or result in electric shock.</p>
	<p><b>Use the specified AC adapter.</b> Using an AC adapter other than that specified may cause the product to fail, heat up, or catch fire, or result in electric shock.</p>
	<p><b>Use an AC adapter of the following size and DC plug polarity.</b> EIAJ Type2 Plug (outer diameter: 4.0 mm, inner diameter: 1.7 mm) </p> <p>Using another type of AC adapter may cause the product to fail, heat up, or catch fire, or result in electric shock.</p>
	<p><b>Using another type of AC adapter may cause the product to fail, heat up, or catch fire, or result in electric shock.</b></p>
	<p><b>Confirm that the outlet is near this board and can be easily unplugged.</b></p>
	<p><b>If smoke or an abnormal smell or sound is emitted or if overheating occurs, promptly switch off the board power and unplug the AC power supply.</b> Using the board in such a state poses a risk of fire, burning or electric shock.</p>



## Warning



**Be careful to avoid burns.**

Parts of the board, especially the area enclosed by a dotted line, become extremely hot.



**Do not look directly at LEDs on this board.**

Doing so may weaken eyesight.  
Use this board with the LED mounting surface back.



**Use a specified AC adapter.**

Using an AC adapter other than that specified causes the product to fail, heat up, or catch fire, or electric shock.



## Caution



**Do not touch directly LEDs on this board.**

Doing so may cause a product failure.

# Table of Contents

1.	Overview.....	1
1.1	Configuration of this product.....	2
1.2	Main features of RL78/G24 DC/DC LED Control Evaluation Board.....	3
2.	Specification .....	4
2.1	Spec. of this board .....	4
2.2	Power input .....	5
2.3	Main components.....	6
2.4	Function .....	8
2.4.1	PowerLED .....	8
2.4.2	Dimming control interface .....	9
2.4.3	On chip debug function .....	14
2.4.4	Arduino UNO R3 Interface connector J3 to J6.....	17
2.4.5	Extended connector J1 ,J2.....	18
3.	Quick start.....	20
4.	Circuit diagram.....	23
5.	Parts list.....	28

## 1. Overview

RTK7RLG240P00000BJ is an evaluation board for LED, DC/DC control and communication by the RL78/G24 microcontroller.

This board can operate with the 5 VDC power supply provided by an AC adapter, which should be prepared separately. The customer should also prepare USB cable.

By using the RL78/G23 Lighting Communication Master Evaluation Board (RTK7RL23LMP00000B) and a GUI tool (which can be downloaded from the Renesas Electronics' website), dimming evaluation by DALI-2, DMX512 or infrared data communication protocol is possible.

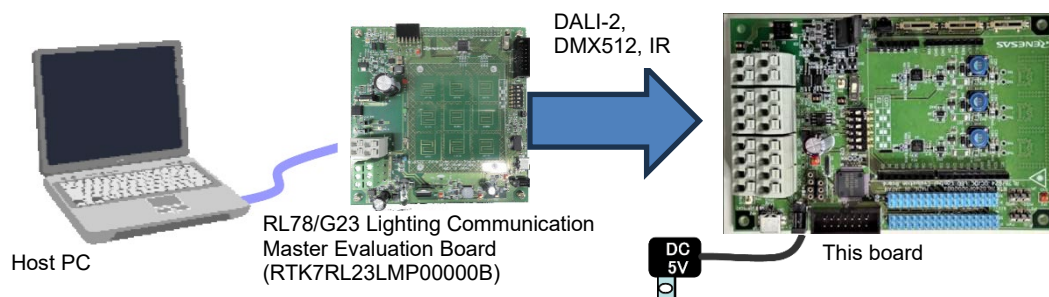

Prepare an USB cable and an AC adapter that satisfies the following:

USB Cable

- TYPE MINI-B that can data communication

AC adapter

- Output Voltage : DC5V
- Output current : > 2A
- Connector : EIAJ- 2 (outer diameter: 4.0 mm, inner diameter: 1.7 mm)



- Circuit type : Switching regulator type with overcurrent protection circuit
- Do not use an AC adapter whose output voltage is guaranteed only when the rated load current flows.



### 1.1 Configuration of this product

This product configures as below :

- RTK7RLG240P0000BJ (RL78/G24 DC/DC LED Control Evaluation board)

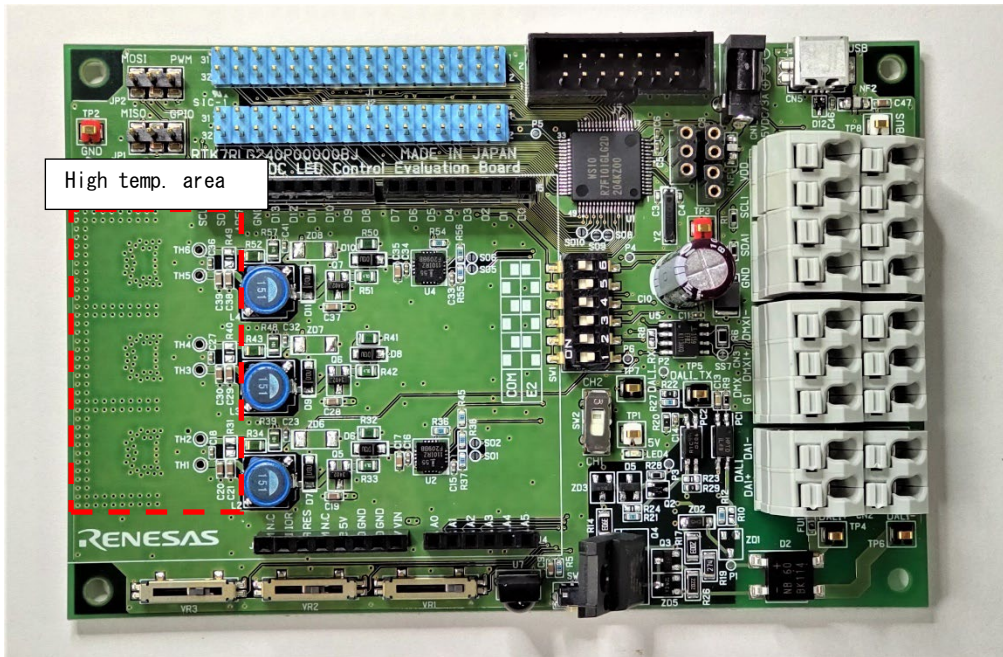

Fig 2-1 Top

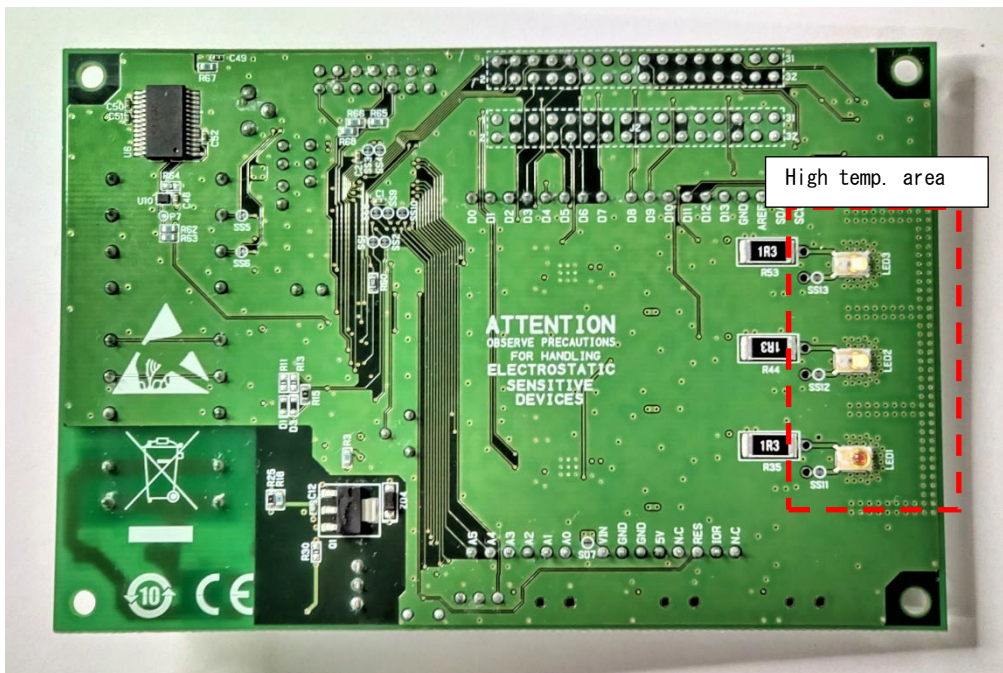

Fig 2-2 Bottom

## 1.2 Main features of RL78/G24 DC/DC LED Control Evaluation Board

- LED lighting system and DC/DC converter control system demonstration capabilities
- This board demonstrates constant current control of LEDs by using 16-bit timers KBN( n = 0, 1, 2 ) dedicated to PWM output
  - Back topology
  - Constant current drive of 350 mA ( max. ) x 3 channels
- 5types of dimming control interface supported
  - DALI-2 protocol communication interface
  - DMX512 protocol communication interface ( also available as RDM-DMX )
  - SMBus/PMbus protocol communication interface
  - IR remote control interface
  - 3 ch. analog volume control interface (for standalone evaluation)
- Easy to use device demonstration capabilities

The RL78/G24 DC/DC LED Control Evaluation Board contains elements to easily demonstrate I/O-functions (i.e. LED output, I/O lines, UART serial interface) together with Real Time Clock (RTC), ADC and Timers. Also, The board has Arduino UNO R3 compatible interface. Various shields can be connected.
- Power supply via 5V DC connector

The RL78/G24 DC/DC LED Control Evaluation Board is powered via a 5V DC jack connector. This power supply is used for power the RL78/I1A as well as the LEDs.
- On-Board debugging function

The RL78/G24 DC/DC LED Control Evaluation Board supports an On-Board debugging function by using the IDE, without the need of additional debugging hardware. It allows flash programming and supports standard debugging functions such as code execution, step execution, software breakpoints, memory manipulation etc. (The E2 emulator lite can also be used for on-chip debugging.)
- Renesas Flash Programmer (RFP)

Windows based Flash programming software allows the user to select and download application programs to the RL78/G24 DC/DC LED Control Evaluation Board for evaluation purposes via USB.

## 2. Specification

This section describes the specification of this products.

### 2.1 Spec. of this board

Describes the specification table as below:

**Table 2-1 Specification Table**

Item	Specification			
<b>Product Name</b>	RTK7RLG240P00000BJ (RL78/G24 DC/DC LED Control Evaluation board)			
<b>List of products</b>	Main product	RTK7RLG240P00000BJ 1pcs		
	Spacer	4 pcs		
	Screw	4 pcs		
	Attached documents	Precautions for use	1 letter	
<b>MCU</b>	RL78/G24 (P/N : R7F101GLG2DFB)			
<b>External sub clock</b>	32.768KHz oscillator			
<b>Converters and Interface</b>	DC/DC Converters and power LED	LED1 (RED)	1ch	
		LED2 (GREEN)	1ch	
		LED3 (BLUE)	1ch	
	Communication / Dimming Interface	DALI	1ch	
		DMX512	1ch	
		SMBus/PMbus	1ch	
		IR Remote Control	1ch	
	Analog volumes	3ch		
	USB *Exclusive use with COM port debugging	UART	1ch	
	Debugging I/F	COM Port debugging E2 emulator/ E2 emulator Lite		
Expanded connector	Expanded connector			
	Arduino UNO R3 I/F connector			
<b>Size</b>	140×90[mm]			
<b>Weight</b>	Around 80g			
<b>Power input</b>	AC adapter	DC5V/2A		
<b>Current consumption</b>	5V/1.1A [max.]	Detail	Board consumption (/w Power LED)	5V/0.05A [max.]
			Power LED consumption	5V/1.050A[max.]
<b>Operation environment</b>	Temperature	0Cdeg~+40Cdeg		
	Humidity	5%~95%RH(no condensation)		



## 2.2 Power input

Describes specification of power input as blow

**Table 2-2 Power input specification**

Power input	Voltage	Current	Power connector	
AC adapter	5V	2A	DC Jack(CN1)	EIAJ-2

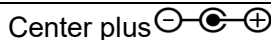
**Table 2-3 Specification of DC Jack**

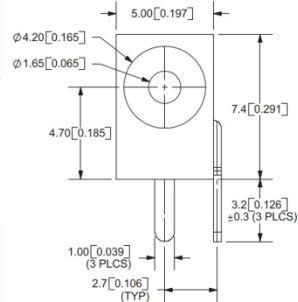
Item		explanation
Manufacture		CUJ
P/N		PJ-018H
Spec.	Input voltage / current	+5V/ >2A
	Recommended Plug	JEITA RC-5320A TYPE2
	Contact num.	3 pole
	Polarity	Center plus 
	Size	 

### Warning



Use an AC adapter that conforms to the safety standard of each country. Using an incorrect AC adapter causes the product to fail, heat up, or catch fire, or result in electric shock.

### 2.3 Main components

The location of main components is shown Fig. 2-1 and Talb 2-4. Also show recommended spec. of cable for DALI communication connector (CN2), DMX512 communication connector(CN3), SMBus/PMBus communication connector(CN4) as Fig.2-2.

●Parts side

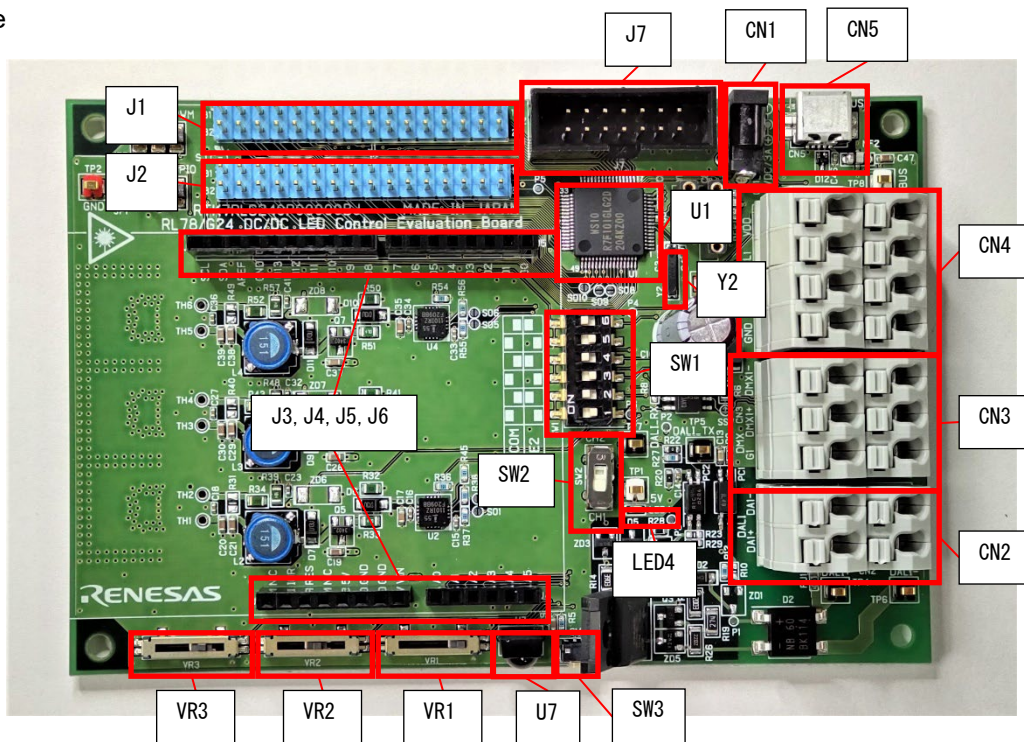

●Soldering side

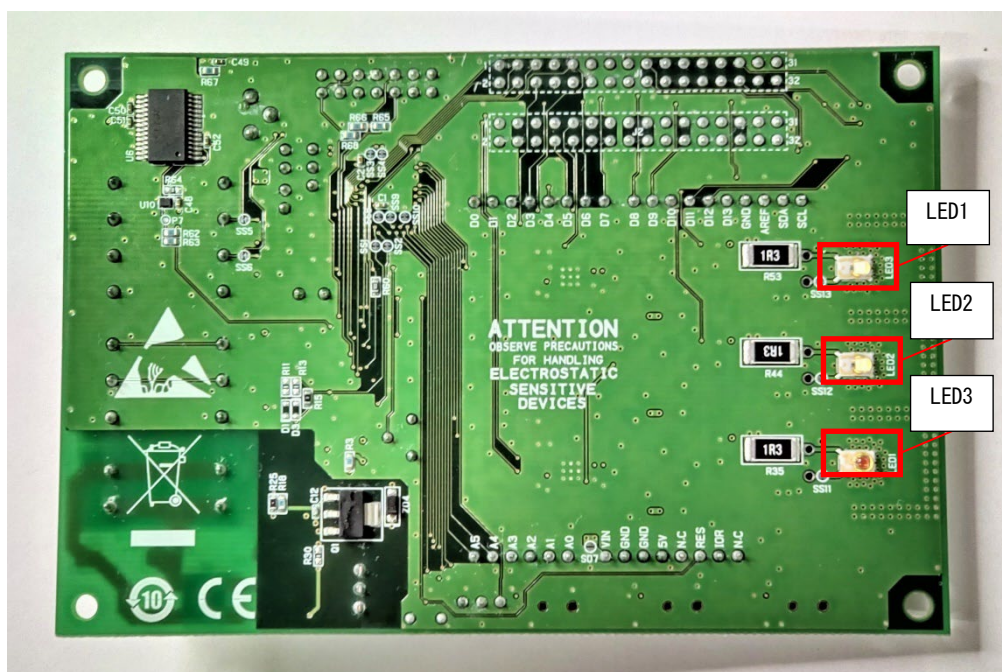
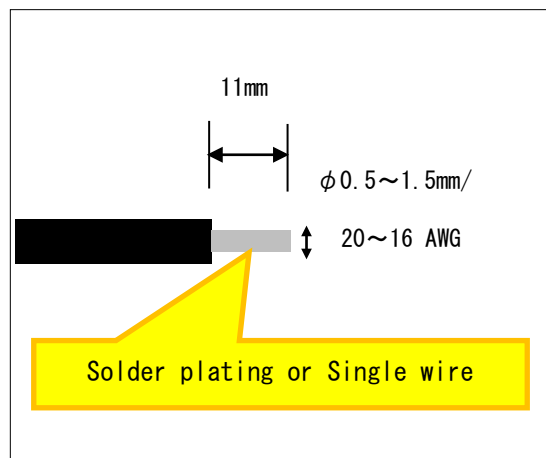

Fig. 2-1 The location of main components

**Table 2-4 Main parts**

Reference Num.	Name	Note
U1	MCU (RL78/G24)	-
Y2	32.768KHz Xtal oscillator	Connected to XT1 OSC circuit ( subclock )
CN1	DC jack	+5V Center EIAJ2
CN5	USB connector	Mini-B type
LED4	Indicator LED	Yellow
CN2	DALI communication connector	Push in/Cascade
CN3	DMX512communication connector	Push in/Cascade
CN4	SMBus/PMBus communication connector	Push in/Cascade
SW1	switch	Operation mode change switch
SW2	switch	IR ch change switch
SW3	Reset Switch	Reset for MCU
U7	IR receiver	-
VR1,VR2,VR3	Analog volume	10kΩ Dimming for LED1,LED2,LED3
J1,J2	Expanded connector	-
J3,J4,J5,J6	Arduino UNO R3 Interface connector	-
J7	Connector for E2 emulator lite	-
LED1	Power LED (RED)	-
LED2	Power LED (GREEN)	-
LED3	Power LED (BLUE)	-



**Fig. 2-2 The specification of recommended communication cable**

## 2.4 Function

This section describes explanation of each function.

### 2.4.1 Power LED

It is equipped with three colors of Power LED: LED1 (red), LED2 (green), and LED3 (blue). The PWM output of the TKBO pin activates the buck converter and controlling each LED. In addition, by detecting the LED current at each analog input terminal, constant current control by feedback can be performed. Constant current control should be performed so that the current value of each LED does not exceed 350mA.

Note 1: Fixing the TKBO pin to the HIGH output by the general-purpose output port is prohibited. Overcurrent can cause the LED to fail.

**Table 2-5 Power LED control port**

Channel	Port	Direction from MCU	Description
LED1(Red)	P12/TKBO00	Out	For buck converter gate PWM control, active high
	P120/ANI19/IVCMP0/PGAI0	In	Current detection for Feedback PGA analog input
LED2(Green)	P13/TKBO01	Out	For buck converter gate PWM control, active high
	P00/ANI29/IVCMP1/PGAI1	In	Current detection for Feedback PGA analog input
LED3(Blue)	P14/TKBO10	Out	For buck converter gate PWM control, active high
	P01/ANI30/IVCMP2/PGAI2	In	Current detection for Feedback PGA analog input

**Table 2-6 Power LED Parts name**

Item	Parts name	Manufacture
LED1(Red)	LXM2-PD01-0050	Lumileds
LED2(Green)	LXML-PM01-0090	
LED3(Blue)	LXML-PB01-0030	

**2.4.2 Dimming control interface**

This board supported 5 types of dimming control interfaces. This section describes each dimming control interface.

- DALI-2 protocol communication interface
- DMX512 protocol communication interface ( also available as RDM-DMX )
- SMbus/PMbus protocol communication interface
- IR remote control interface
- 3 ch. analog volume control interface (for standalone evaluation)

**2.4.2.1 DALI-2 protocol communication interface**

It is equipped with connector CN2 for DALI protocol communication interface and enables communication with the DALI Control device. In order to enable cascading of connectors, the signals printed on silk are connected as the same signal in the front (1st stage) and back (2nd stage) of the connector.

**Table 2-7 DALI-2 protocol communication port**

Port name	Direction from MCU	Description
P02/(DALITxD0) <sup>Note1</sup>	Out	DALI sending signal
P03/(DALIRxD0) <sup>Note1</sup>	In	DALI receiving signal

Note 1 : PIOR registers setting is needed

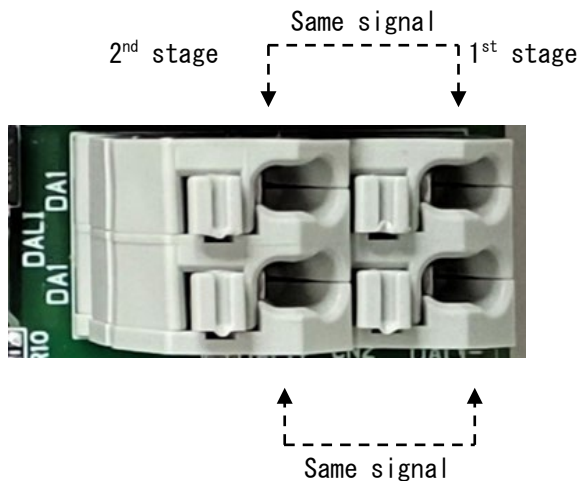

**Fig. 2-3 DALI communication connector CN2**



2.4.2.2 DMX512 protocol communication interface

It is equipped with connector CN3 for DMX512 protocol communication interface and enables communication with the DMX512 master. In order to enable cascading of connectors, the signals printed on silk are connected as the same signal in the front (first stage) and back (second stage) of the connector.

Table 2-8 DMX512 protocol communication port

Port name	Direction from MCU	Description
P77/(Tx/D2) <sup>Note1</sup>	Out	DMX512 sending signal
P76/(Rx/D2) <sup>Note1</sup>	In	DMX512 receiving signal
P31/TI03	In	DMX512 receiving signal
P30	Out	DMX512 direction signal HIGH=Enable sending LOW=Enable receiving

Note 1 : PIOR registers setting is needed

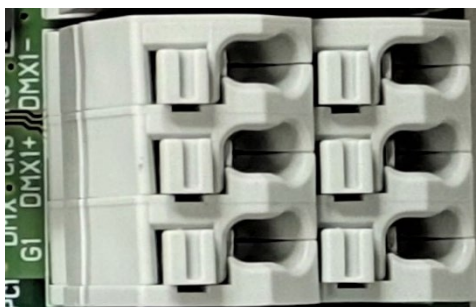

Fig. 2-4 DMX512 communication connector CN3

**2.4.2.3 SMbus/PMbus protocol communication interface**

It is equipped with connector CN4 for SMbus/PMbus protocol communication interface and enables communication with the SMbus/PMbus master. In order to enable cascading of connectors, the signals printed on silk are connected as the same signal in the front (first stage) and back (second stage) of the connector.

**Table 2-9 SMbus/PMbus protocol communication port**

Port name	Direction from MCU	Description
P60/SCLA0	In/Out	Serial clock in/out signal
P61/SDAA0	In/Out	Serial data in/out signal

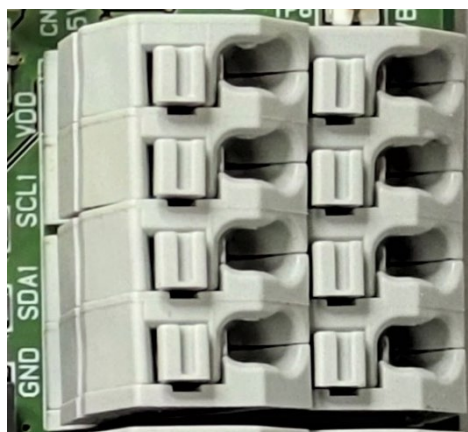

**Fig. 2-5 SMbus/PMbus communication connector CN4**

2.4.2.4 IR remote control interface

The infrared (IR) detector U7 can be used for performing IR communication between the controller device and the RL78/G24. The controller device can send commands to the RL78/G24 microcontroller using the IR communication protocol.

Table 2-10 IR remote control interface control port

Port name	Direction from MCU	Description
P17/TI02	In	IR detection port
P140/INTP6	In	IR channel select port

● IR detector U7

Describes basic specification of IR detector U7



Table 2-11 IR detector U7 basic specification

Parts name	Manufacture	BPF Center frequency	Angle
BRM-2508	American Bright Optoelectronics	38kHz (typ.)	45 degree (typ.)

● Switch SW2

IR remote control channel can be selected by switch SW2. Setting is below.

Table 2-12 Switch SW2 setting

Setting		Description
Setting slide bar to CH1 silk side	CH1  CH2	CH1 selected
Setting slide bar to CH2 silk side	CH1  CH2	CH2 selected

2.4.2.5 Analog volume control interface

Three volumes are included for stand-alone evaluation. It can be used as a brightness indication for LED1 (red), LED2 (green), and LED3 (blue) LEDs. For how to operate volumes, see Fig. 2-6.

Table 2-13 Volume connected port

Port name	Direction from MCU	Description
P22/ANI2	In	LED1 (Red) dimming setting (VR1)
P147/ANI18	In	LED2 (Green) dimming setting (VR2)
P146/ANI28	In	LED3 (Blue) dimming setting (VR3)



Fig. 2-6 Volume VR1, VR2, VR3

Minimum position

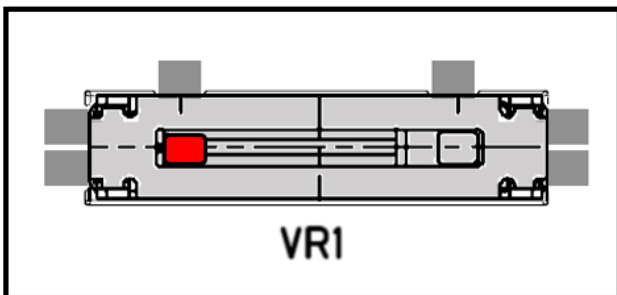

Maximum position

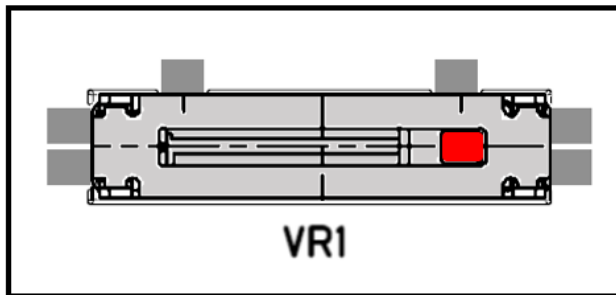

Fig. 2-6 Volume position



**2.4.3 On chip debugging function**

The product supports two on-chip debugging methods: COM Port debugging (Chapter 2.4.3.2) and debugging using the E2 emulator/E2 emulator Lite (Chapter 2.4.3.3). The on-chip debugging method and normal operating mode are switched by switch SW1.

**2.4.3.1 Switch SW1**

Controls various operating modes. Each operation mode and setting are as follows.

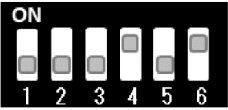
**Table 2-14 Switch Sw1 setting**

Mode	Description	
Normal operation mode		Turn on bit 4 and 6
COM port debugging mode		Turn on bit 1, 3 and 5
E2 emulator / E2 emulator lite mode		Turn on bit 2, 4 and 6

**2.4.3.2 COM Port debugging / Virtual UART communication**

COM Port debugging is a function that allows you to debugging application software or write a flash program to RL78/G24 devices via USB connection. Connects to a host system via the Mini-B USB connector (CN5).

The RL78/G24 device ~ USB connector is connected via a USB serial converter (FT232RL).

Note that COM Port debugging and virtual UART interface share the same control port, so they are used exclusively.

**Table 2-15 USB interface port**

Port name	Direction from MCU	Description
P51/TOOLTxD	Out	COM Port debugging sending signal
P51/TxD0		Virtual UART sending signal
P50/TOOLRxD	In	COM Port debugging receiving signal
P50/RxD0		Virtual UART receiving signal
RESET (Low Active)	In	Reset signal *Reset control is controlled by DTR signal of USB serial converter when use COM Port debugging.

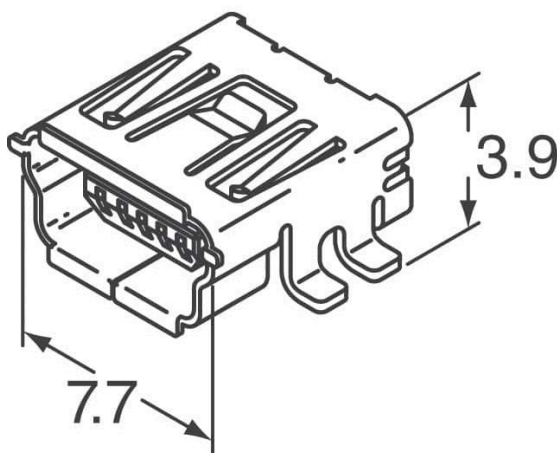

**Fig. 2-7 Out shape of Mini-B USB type connector**

2.4.3.3 E2 emulator / E2 emulator lite debugging

This function enables on-chip debugging and flash program writing via E2 Emulator / E2 Emulator Lite (manufactured by Renesas Electronics). Connect the user interface cable (14-pin) of the E2 emulator Lite accessory to the debugging connector (J7) of this product and connect to the host system. Using this method, it is possible to perform virtual serial communication and debugging by COM Port at the same time.

Table2-16 Debugging connector (J7) specification

Number of positions	Number of columns	Pitch	Connector type	Mounting type	Parts name	Manufacturer
14 pin	2	2.54mm	Male	Through hole	7614-6002	3M Japan

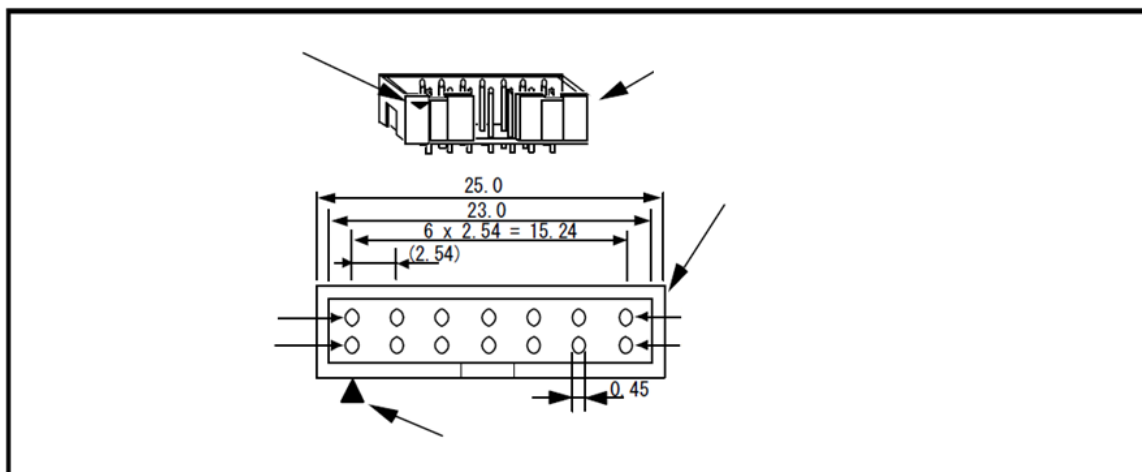

Fig. 2-8 Out shape of Debugging connector

Table2-17 Debugging connector (J7) pin assignment

Pin num.	Pine name	Direction *	Function
1	N.C	—	—
2	GND	—	—
3	N.C	—	—
4	N.C	—	—
5	TOOL0	In/Out	Command and data sending / receiving
6	RESI	Out	Reset signal to emulator from the product
7	N.C	—	—
8	VDD	—	—
9	EVDD	In	—
10	RESO	In	Reset signal to the product from emulator
11	N.C	—	—
12	GND	—	—
13	RESO	In	Reset signal to the product from emulator
14	GND	—	—

\* Direction detail : Input = The product <- emulator, Output = The product -> Emulator

2.4.4 Arduino UNO R3 Interface connector J3 to J6

J3~J6 is the Arduino UNO R3 interface connector. A 2.54 pitch, straight socket is implemented. For electrical specifications of the available pins, refer to the user's manual for the RL78/G24 device. Fig. 2-9 shows the pin assignments and precautions when using them.

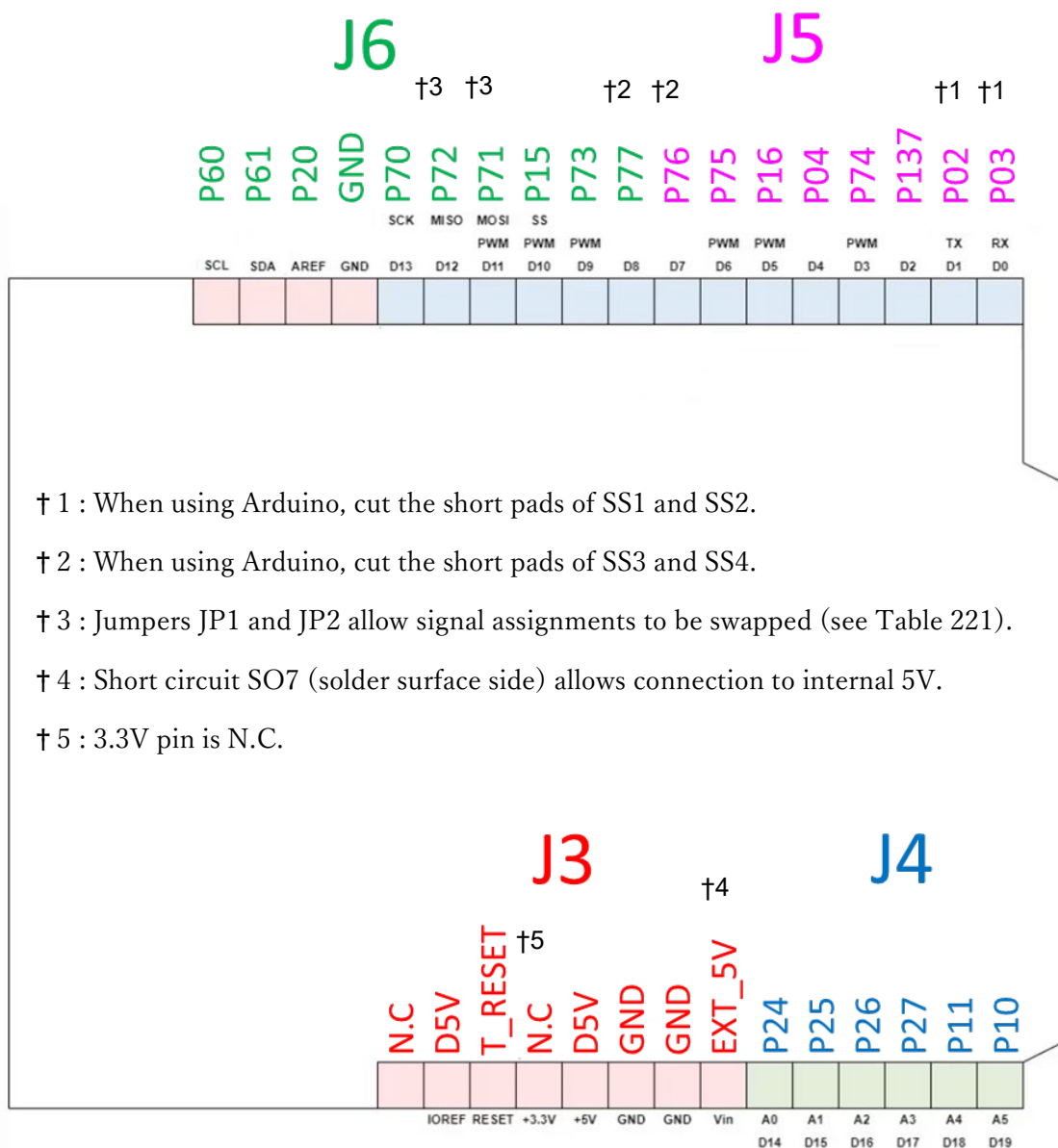

Fig. 2-9 Pin assignment of Arduino UNO R3 Interface connector J3 to J6

Table 2-18 Jumper JP1, JP2 setting

Jumper	Setting	J6 pin	Signal assignment
JP1	GPIO side (Short 1 and 2)	J6-5 pin	P72
JP2	PWM side (Short 1 and 2)	J6-4 pin	P71
JP1	MISO side (Short 2 and 3)	J6-5 pin	P71
JP2	MOSI side (Short 2 and 3)	J6-4 pin	P72



### 2.4.5 Extended connector J1 ,J2

J1 and J2 are connectors for external user hardware. A 2.54 pitch, straight header is implemented and connected to the RL78/G24 pin. For electrical specifications of the available pins, refer to the user's manual for the RL78/G24 device. Table 2-19 and 2-20 show the pin assignments.

**Table 2-19 Extended J1 pin assignment**

Extended connector (J1)		MCU	
Pin num	Pin name	Pin num.	Pin name
1	P120/ANI19/IVCMP0/PGAI0	1	P120/ANI19/IVCMP0/PGAI0/TRGIDZ/TRGTRG
2	P43	2	P43/(INTP9)
3	P42	3	P42/(INTP8)
4	P41	4	P41/(TRJIO0)
5	P40/TOOL0	5	P40/TOOL0
6	T_RESET	6	RESET
7	N.C	-	-
8	N.C	-	-
9	P137	9	P137/INTP0
10	N.C	-	-
11	N.C	-	-
12	N.C	-	-
13	GND	13,14	VSS, EVSS
14	GND	13,14	VSS, EVSS
15	D5V	15,16	VDD, EVDD
16	D5V	15,16	VDD, EVDD
17	P60/SCLA0	17	P60/CCD04/SCLA0
18	P61/SDAA0	18	P61/CCD05/SDAA0
19	P62	19	P62/CCD02/SSI00
20	P63	20	P63/CCD03
21	P31	21	P31/TI03/TO03/INTP4/(TRJIO0)/(VCOUT0)/(PCLBUZ0)
22	P77/(TxD2)	22	P77/KR7/INTP11/(TxD2)
23	P76/(RxD2)	23	P76/KR6/INTP10/(RxD2)
24	P75	24	P75/KR5/INTP9/SCK01/SCL01/(TRDIOD1)
25	P74	25	P74/KR4/INTP8/SI01/SDA01/(TRDIOB1)
26	P73	26	P73/KR3/(RxD1)/(TRDIOC1)/SO01
27	P72	27	P72/KR2/SO21/(TxD1)/(TRDIOA1)
28	P71	28	P71/KR1/SI21/SDA21/(TI01)/(TO01)/(TRDIOD0)
29	P70	29	P70/(TRDIOB0)/KR0/SCK21/SCL21
30	P06_LED1PD	30	P06/(INTP11)/(TRJIO0)
31	P05_LED1EN	31	P05/(INTP10)
32	P30_DM512_EN	32	P30/INTP3/RTC1HZ/SCK00/SCL00/TRJIO0/(VCOUT1)

\* If the pin name of the external connector is the port name alone, it is unused on the board and is directly connected to the MCU. If the pin name is not the port name alone, it is used for the circuit in the board.

\* Terminals used in the Arduino UNO R3 interface connector are shown in blue.

**Table 2-20 Extended J2 pin assignment**

Extended connector (J2)		MCU	
Pin num	Pin name	Pin num	Pin name
1	P50/RxD0/TOOLRxD	33	P50/INTP1/SI00/RxD0/TOOLRxD/DALIRxD0/SDA00/TRGIOA/(TRJ00)/(TI03)/(VCOUT3)
2	P51/TxD0/TOOLTxD	34	P51/INTP2/SO00/TxD0/TOOLTxD/DALITxD0/TRGIOB/(VCOUT2)
3	P52_LED2EN	35	P52/(INTP1)
4	P53_LED2PD	36	P53/(INTP2)
5	P54_LED3EN	37	P54/(INTP3)
6	P55_LED3PD	38	P55/(PCLBUZ1)/(SCK00)/(INTP4)
7	P17/TI02	39	P17/CCD01/TI02/TO02/TRDIOA0/TRDCLK/TKBO21/(TxD0)/(TRGIOA)/ANI27/(SO00)
8	P16	40	P16/ANI26/CCD00/TI01/TO01/INTP5/TRDI0C0/TKBO20/IVREF0/(RxD0)/(TRGIOB)/(SI00)
9	P15	41	P15/SCK20/SCL20/TRDIOB0/TKBO11/VCOUT1/(SDAA0)/ANI25
10	P14/TKBO10	42	P14/RxD2/SI20/SDA20/TRDIOD0/TKBO10/VCOUT0/(SCLA0)/ANI24
11	P13/TKBO01	43	P13/ANI23/TxD2/SO20/TRDIOA1/TKBO01/(TRDI0C0)
12	P12/TKBO00	44	P12/ANI22/SO11/TRDIOB1/TKBO00/IVREF1/(INTP5)/(TxD0_1)
13	P11	45	P11ANI21/PGA0/CCD07/SI11/SDA11/TRDI0C1/(TO03)/(RxD0_1)/VCOUT3
14	P10	46	P10/ANI20/CCD06/SCK11/SCL11/TRDIOD1/VCOUT2
15	P146/ANI28	47	P146/ANI28
16	P147/ANI18	48	P147/ANI18/ANO2/IVCMP3/PGA13
17	P27	49	P27/ANI7
18	P26	50	P26/ANI6
19	P25	51	P25/ANI5
20	P24	52	P24/ANI4
21	P23/PGAGND	53	P23/ANI3/ANO1/PGAGND
22	P22/ANI2	54	P22/ANI2/ANO0/PGA14
23	P21/AVREFM	55	P21/ANI1/AVREFM/(INTP7)
24	P20/AVREFP	56	P20/ANI0/AVREFP/(INTP6)
25	P130	57	P130
26	P04	58	P04/SCK10/SCL10
27	P03/(DALIRxD0)	59	P03/ANI16/RxD1/(DALIRxD0)/(TI00)/SI10/SDA10
28	P02/(DALITxD0)	60	P02/ANI17/TxD1/(DALITxD0)/SO10
29	P01/ANI30/IVCMP2/PGA12	61	P01/ANI30/IVCMP2/PGA12/TO00/TRGCLKB/TRJIO0
30	P00/ANI29/IVCMP1/PGA11	62	P00/ANI29/IVCMP1/PGA11/TI00/TRGCLKA/(TRJ00)
31	P141	63	P141/PCLBUZ1/INTP7
32	P140/INTP6	64	P140/PCLBUZ0/INTP6

### 3. Quick start

This chapter explains programming and operation. This chapter covers how to start the system, execute the EPV command (Erase, Program, Verify), operate RL78/G24 device.

The conditions of the series of operations described in this chapter are as follows:

Hardware Configuration of this board

Board : RTK7RLG240P00000BJ (RL78/G24 DC/DC LED Control Evaluation Board)

CPU : RL78/G24

Target device : R7F101GL

Voltage level : 5 V

Software configuration of RFP

Operation setting : Erase, Write, Verify

Tool : COM port

Interface : 2 wire UART

Speed : 115200 bps

Tool detail : COMx ( depends on environment each PC )

Write HEX file : \*.hex, \*.mot

1. Setting and connecting

Connect power source with this board and set the switch SW1 as following:

**Table 3-1 COM Port Setting for Debugging**

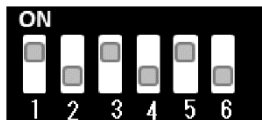
Mode	Description
COM Port Debugging mode	 <p>Turn on bit 1, 3 and 5</p>

Connect this board with host PC.

2. Starting

Start the RFP from the start menu:

[Start] - [All Programs] - [Renesas Electronics Utilities] - [Renesas Flash Programmer Vx.xx]

3. Creating project

Select [File] - [New project]

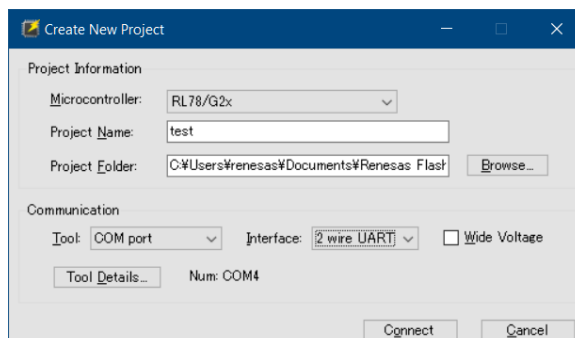

**Fig. 3-1 Create New Project**

Open new project window  
 Select Target microcontroller and input project name.  
 Select Tool (COM port), Interface(2 wire UART), COM port num in Tool details.  
 Click connect button

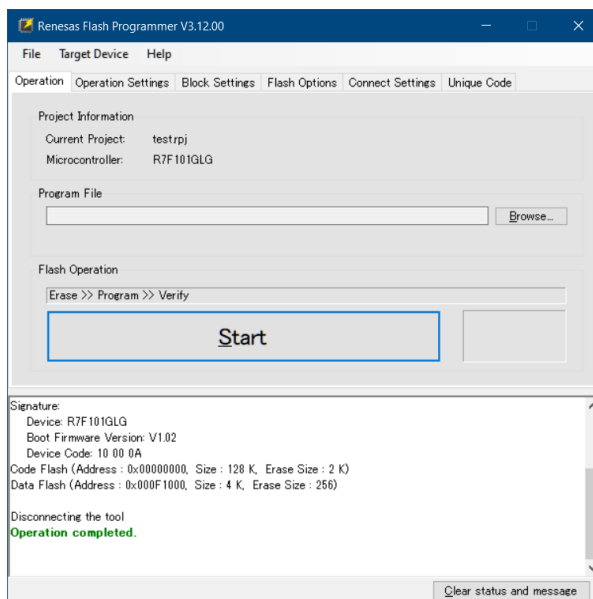

Fig. 3-2 Connected

4. Execution

Select the program file to be written to the target microcontroller in the “User/Data area” box.

Next, click Start to start writing of the selected program file.

When “completed” is displayed, close the window.

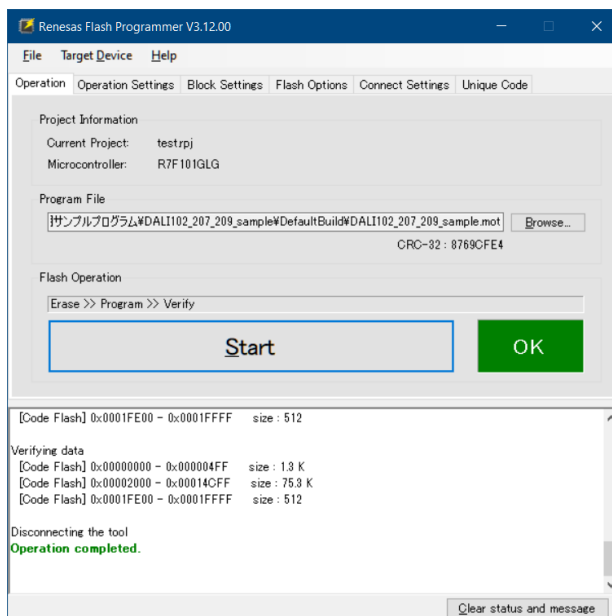
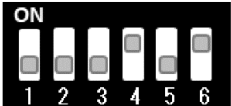

Fig. 3-3 Complete Flash

5. Terminating  
 Select [File] - [Quit] to terminate the RFP.

6. Execute application  
 Set this board to the normal operation mode by applying the following settings.

**Table 3-2 COM Port Setting for Normal Operation**

Mode	Description
Normal operation mode	 <p>Turn on bit 4 and 6</p>

# 4. Circuit diagram

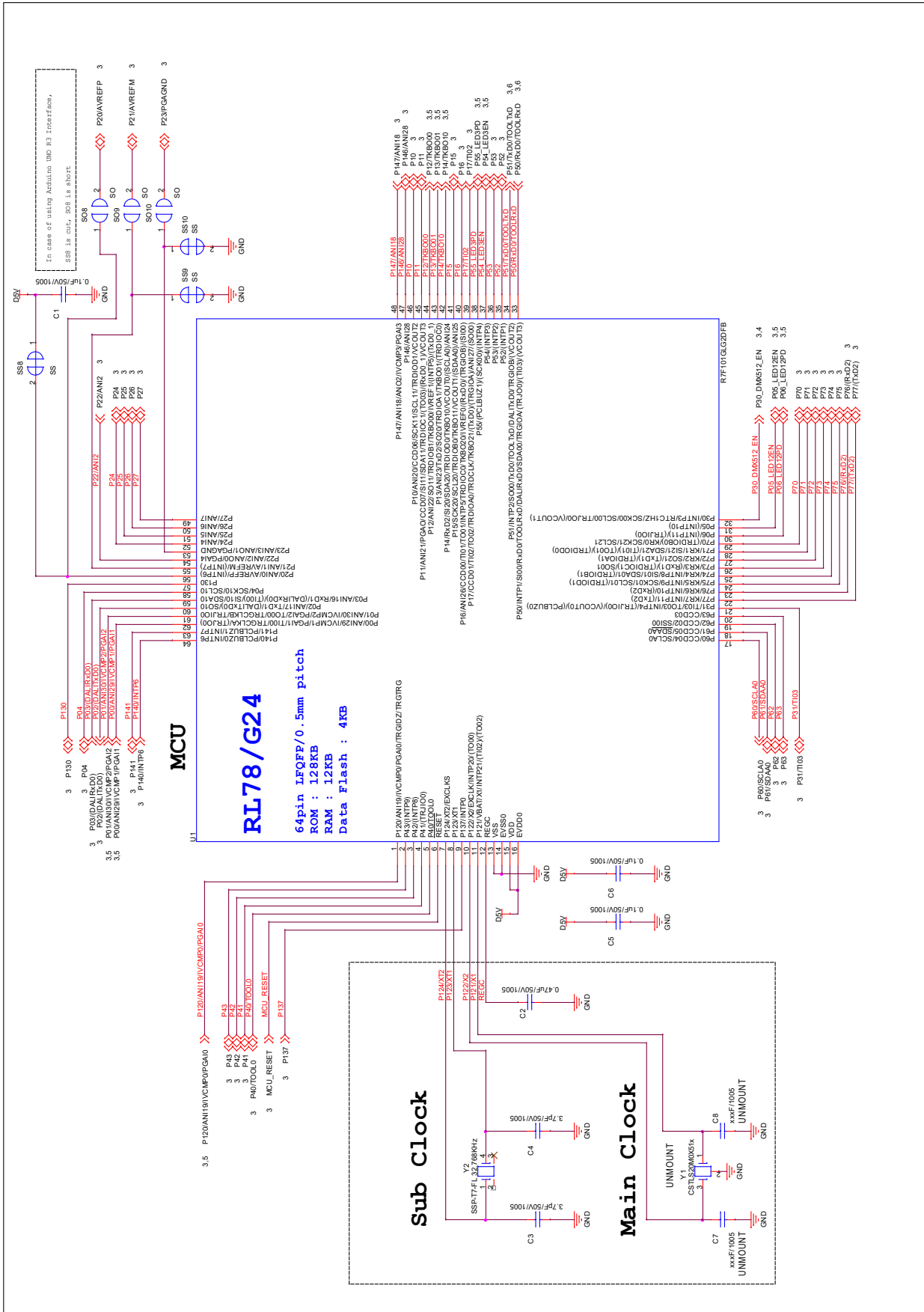

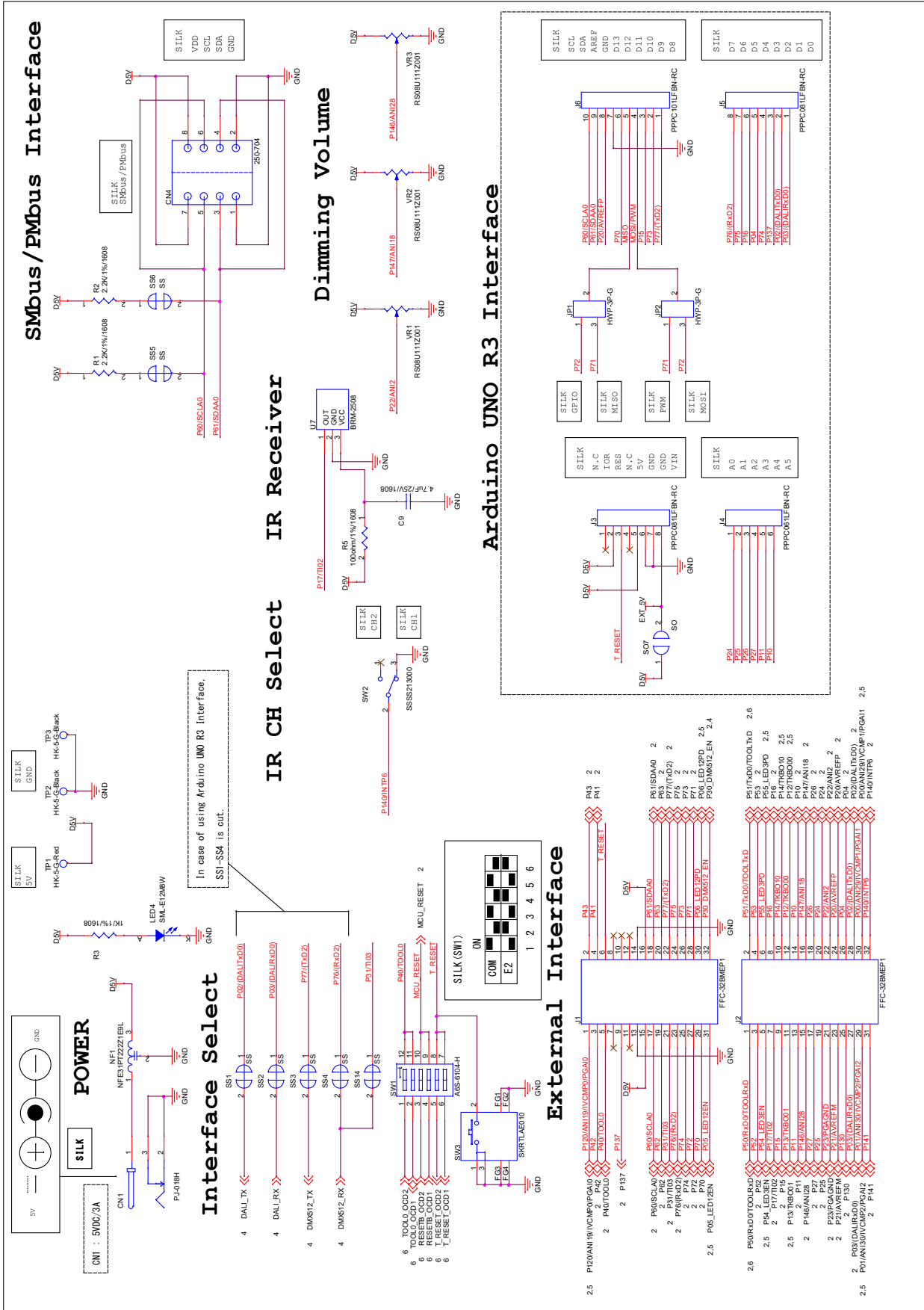

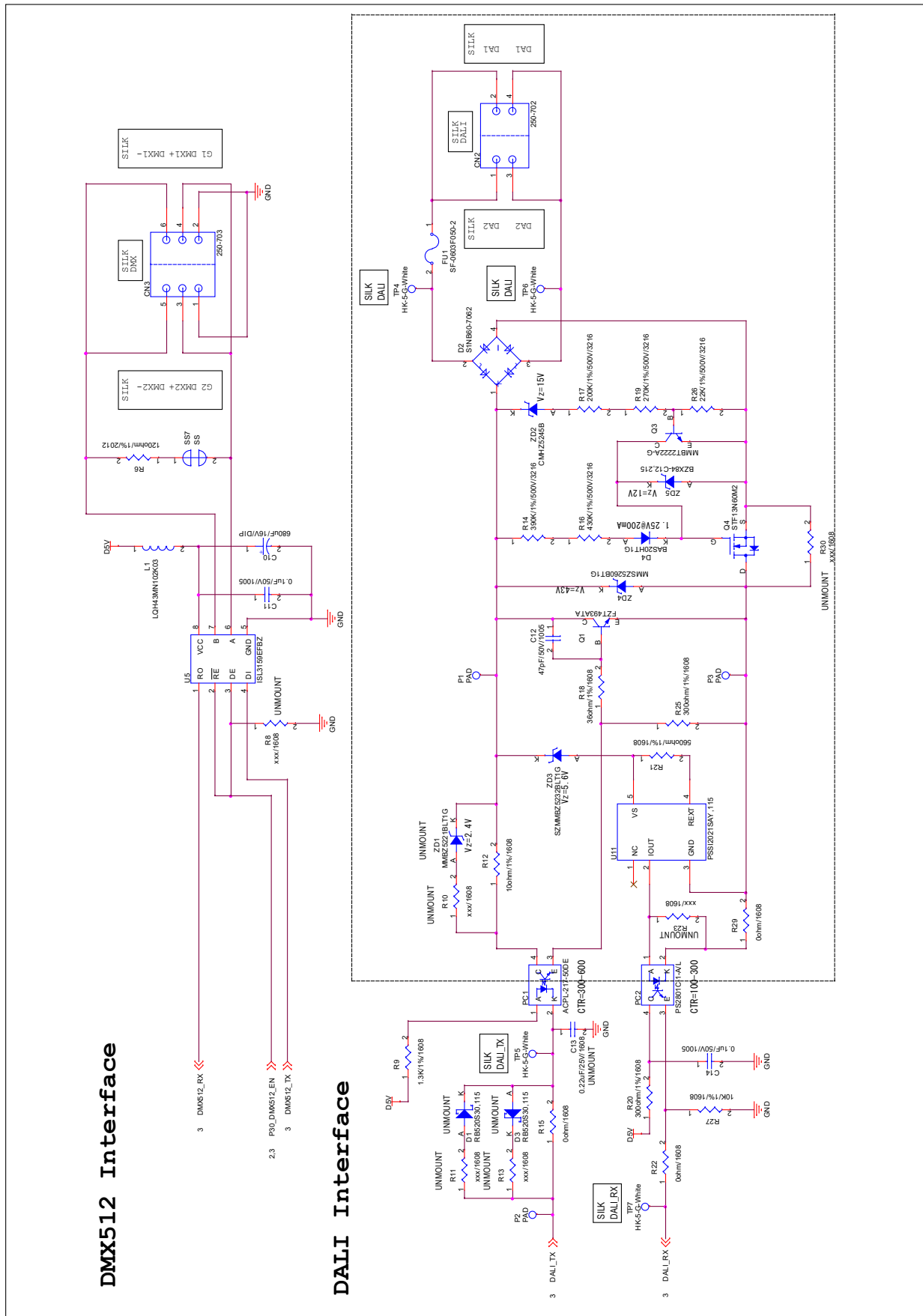



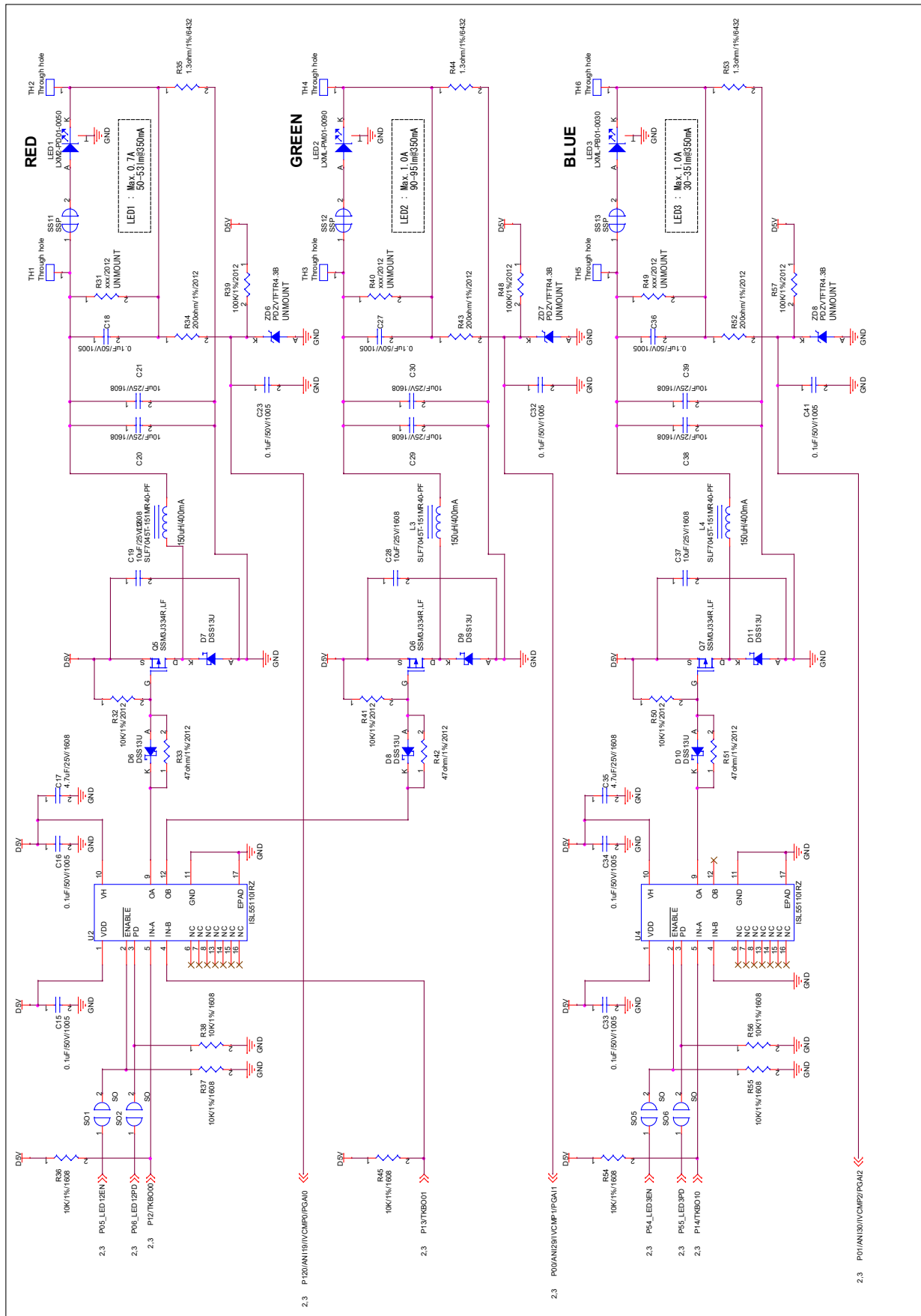

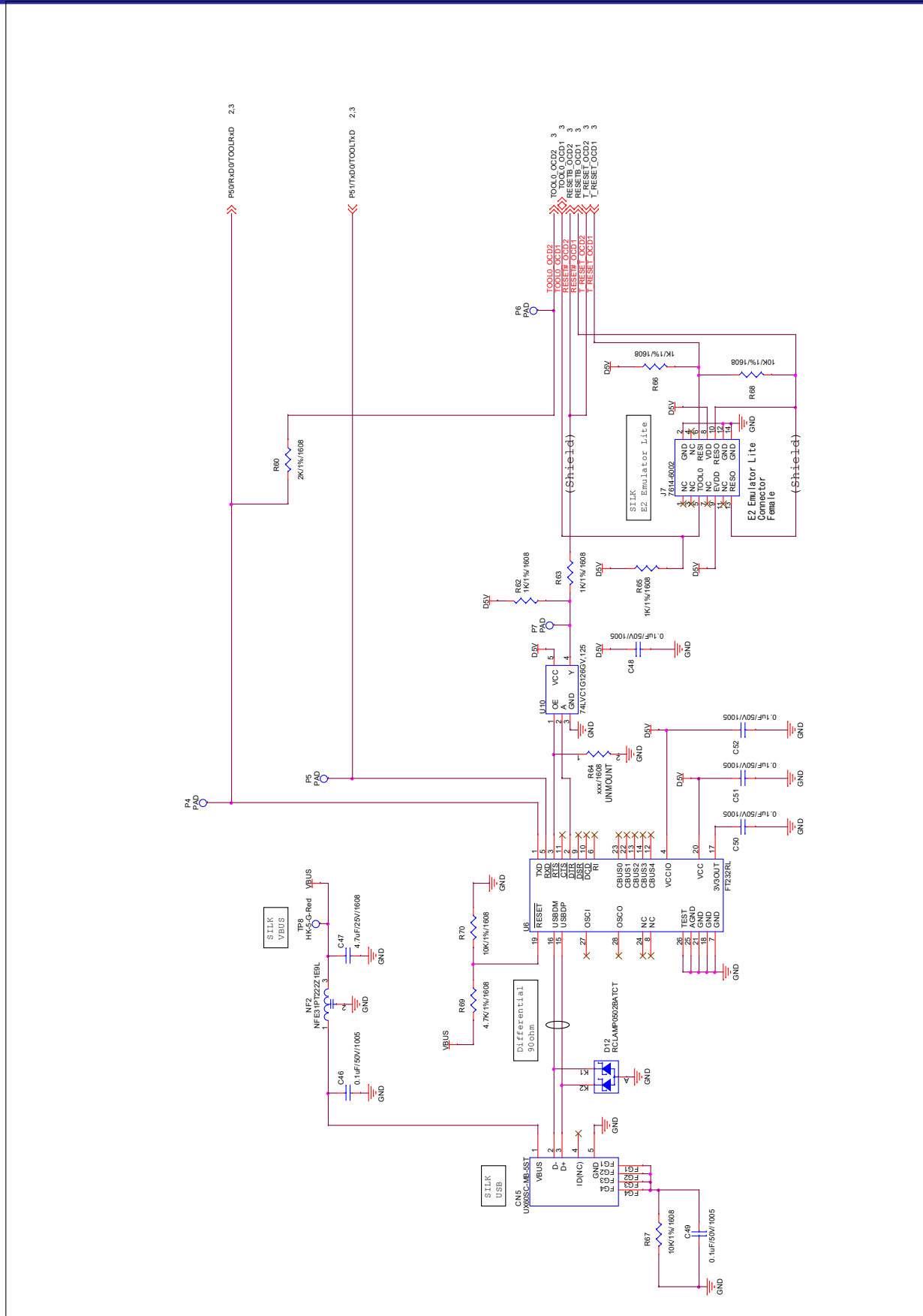

## 5. Parts list

ItemNo	Quantity	Mount component reference	Unmount component reference	Schematic part name	Kind	Part name	Manufacture
1	1	CN1		PJ-018H	JACK	PJ-018H	CUI Devices
2	1	CN2		250-702	Terminal Block	250-702	WAGO
3	1	CN3		250-703	Terminal Block	250-703	WAGO
4	1	CN4		250-704	Terminal Block	250-704	WAGO
5	1	CN5		UX60SC-MB-5ST	USB Connector	UX60SC-MB-5ST	Hirose Electric
6	21	C1,C5,C6,C11,C14,C15,C16,C18,C23,C27,C32,C33,C34,C36,C41,C46,C48,C49,C50,C51,C52		0.1uF/50V/1005	CERAMIC CAPACITOR	GRT155R71H104KE01D	Murata Electronics
7	1	C2		0.47uF/50V/1005	CERAMIC CAPACITOR	GRM155R61H474KE11D	Murata Electronics
8	2	C4,C3		3.7pF/50V/1005	CERAMIC CAPACITOR	GCQ1555C1H3R7CB01D	Murata Electronics
9	2	C7,C8		xxxF/1005	Pin Socket	801-87-002-10-001101	Preci-Dip
10	4	C9,C17,C35,C47		4.7uF/25V/1608	CERAMIC CAPACITOR	GRM188R61E475KE11D	Murata Electronics
11	1	C10		680uF/16V/DIP	ALUMINUM CAPACITOR	UPW1C681MPD6	Nichicon
12	1	C12		47pF/50V/1005	CERAMIC CAPACITOR	GCM1555C1H470JA16J	Murata Electronics
13	0		C13	0.22uF/25V/1608	CERAMIC CAPACITOR	CC0603JRX7R8BB224	YAGEO
14	9	C19,C20,C21,C28,C29,C30,C37,C38,C39		10uF/25V/1608	CERAMIC CAPACITOR	GRM188R61E106KA73D	Murata Electronics
15	0		D3,D1	RB520S30,115	Schottky Diode	RB520S30,115	Nexperia USA
16	1	D2		S1NB60-7062	Bridge Rectifiers	S1NB60-7062	Shindengen
17	1	D4		BAS20HT1G	Diode	BAS20HT1G	onsemi
18	6	D6,D7,D8,D9,D10,D11		DSS13U	Schottky Diode	DSS13U	SMC Diode Solutions
19	1	D12		RCLAMP0502BATCT	TVS Diode	RCLAMP0502BATCT	Semtech
20	1	FU1		SF-0603F050-2	FUSE	SF-0603F050-2	Bourns
21	2	JP2,JP1		HWP-3P-G	Pin Header	HWP-3P-G	MAC8
22	2	J2,J1		FFC-32BMEP1	Pin Header	FFC-32BMEP1	Honda
23	2	J5,J3		PPPC081LFBN-RC	Pin Socket	PPPC081LFBN-RC	Sullins Connector Solutions
24	1	J4		PPPC061LFBN-RC	Pin Socket	PPPC061LFBN-RC	Sullins Connector Solutions
25	1	J6		PPPC101LFBN-RC	Pin Socket	PPPC101LFBN-RC	Sullins Connector Solutions
26	1	J7		7614-6002	Connector	7614-6002BL	3M
27	1	LED1		LXM2-PD01-0050	LED	LXM2-PD01-0050	Lumileds
28	1	LED2		LXML-PM01-0090	LED	LXML-PM01-0090	Lumileds
29	1	LED3		LXML-PB01-0030	LED	LXML-PB01-0030	Lumileds
30	1	LED4		SML-E12M8W	LED	SML-E12M8W	Rohm Semiconductor
31	1	L1		LQH43MN102K03	Inductor	LQH43MN102K03	Murata Electronics
32	3	L2,L3,L4		SLF7045T-151MR40-PF	Inductor	SLF7045T-151MR40-PF	TDK
33	2	NF2,NF1		NFE31PT222Z1E9L	Filter	NFE31PT222Z1E9L	Murata Electronics
34	1	PC1		ACPL-217-50DE	Photo Coupler	ACPL-217-50DE	Broadcom Limited
35	1	PC2		PS2801C-1-A/L	Photo Coupler	PS2801C-1-A/L	Renesas Electronics
36	0		P1 to P7	PAD	PAD		
37	1	Q1		FZT493ATA	Transistor	FZT493ATA	Diodes Incorporated
38	1	Q3		MMBT2222A-G	Transistor	MMBT2222A-G	Comchip Technology
39	1	Q4		STF13N60M2	Transistor	STF13N60M2	STMicroelectronics
40	3	Q5,Q6,Q7		SSM3J334R,LF	Transistor	SSM3J334R,LF	TOSHIBA
41	2	R1,R2		2.2K/1%/1608	Resistor	RK73H1JTTD2201F	KOA Speer Electronics

42	5	R3,R62,R63,R65,R66		1K/1%/1608	Resistor	RK73H1JTDD1001F	KOA Speer Electronics
43	11	R27,R36,R37,R38,R45,R54, R55,R56,R67,R68,R70		10K/1%/1608	Resistor	RK73H1JTDD1002F	KOA Speer Electronics
44	1	R5		100ohm/1%/1608	Resistor	RK73H1JTDD1000F	KOA Speer Electronics
45	1	R6		120ohm/1%/2012	Resistor	RK73H2ATDD1200F	KOA Speer Electronics
46	0		R8,R10,R11,R13 R23,R30,R64	xxx/1608	Resistor		
47	1	R9		1.3K/1%/1608	Resistor	RK73H1JTDD1301F	KOA Speer Electronics
48	1	R12		10ohm/1%/1608	Resistor	RK73H1JTDD10R0F	KOA Speer Electronics
49	1	R14		390K/1%/500V/3216	Resistor	KTR18EZPF3903	Rohm Semiconductor
50	3	R15,R22,R29		0ohm/1608	Resistor	RK73Z1JTDD	KOA Speer Electronics
51	1	R16		430K/1%/500V/3216	Resistor	KTR18EZPF4303	Rohm Semiconductor
52	1	R17		200K/1%/500V/3216	Resistor	KTR18EZPF2003	Rohm Semiconductor
53	1	R18		36ohm/1%/1608	Resistor	RK73H1JTDD36R0F	KOA Speer Electronics
54	1	R19		270K/1%/500V/3216	Resistor	KTR18EZPF2703	Rohm Semiconductor
55	2	R20,R25		300ohm/1%/1608	Resistor	RK73H1JTDD3000F	KOA Speer Electronics
56	1	R21		560ohm/1%/1608	Resistor	RK73H1JTDD5600F	KOA Speer Electronics
57	1	R26		22K/1%/500V/3216	Resistor	KTR18EZPF2202	Rohm Semiconductor
58	0		R31,R40,R49	xxx/2012	Resistor		
59	3	R32,R41,R50		10K/1%/2012	Resistor	RK73H2ATDD1002F	KOA Speer Electronics
60	3	R33,R42,R51		47ohm/1%/2012	Resistor	RK73H2ATDD47R0F	KOA Speer Electronics
61	3	R34,R43,R52		200ohm/1%/2012	Resistor	RK73H2ATDD2000F	KOA Speer Electronics
62	3	R35,R44,R53		1.3ohm/1%/6432	Resistor	ERJ-1TRQF1R3U	Panasonic Electronic
63	3	R39,R48,R57		100K/1%/2012	Resistor	RK73H2ATDD1003F	KOA Speer Electronics
64	1	R60		2K/1%/1608	Resistor	RK73H1JTDD2001F	KOA Speer Electronics
65	0		SO1 to 10	SO	ShortPAD		
66	0		SS1 to SS14	SS	ShortPAD		
67	1	SW1		A6S-6104-H	Switch	A6S-6104-H	Omron Electronics
68	1	SW2		SSSS213000	Switch	SSSS213000	Alps Alpine
69	1	SW3		SKRTLAE010	Switch	SKRTLAE010	Alps Alpine
70	0		TH1 to TH6	Through hole	Through hole		
71	2	TP8,TP1		HK-5-G-Red	Test Pin	HK-5-G-Red	MAC8
72	2	TP3,TP2		HK-5-G-Black	Test Pin	HK-5-G-Black	MAC8
73	4	TP4,TP5,TP6,TP7		HK-5-G-White	Test Pin	HK-5-G-White	MAC8
74	1	U1		R7F101GLG2DFB	IC	R7F101GLG2DFB	Renesas Electronics
75	2	U2,U4		ISL55110IRZ	IC	ISL55110IRZ	Renesas Electronics
76	1	U5		ISL3159EFBZ	IC	ISL3159EFBZ	Renesas Electronics
77	1	U6		FT232RL	IC	FT232RL	FTDI
78	1	U7		BRM-2508	IC	BRM-2508	American Bright Optoelectronics
79	1	U10		74LVC1G126GV,125	IC	74LVC1G126GV,125	Nexperia
80	3	VR1,VR2,VR3		RS08U111Z001	Variable Resistor	RS08U111Z001	Alps Alpine
81	1	Y1		CSTLS20M0X51x	Pin Socket	801-87-003-10-001101	Preci-Dip
82	1	Y2		SSP-T7-FL 32.768KHz	CRYSTAL	SSP-T7-FL 32.768KHz	Seiko Instruments
83	0		ZD1	MMBZ5221BLT1G	Zener Diode	MMBZ5221BLT1G	onsemi
84	1	ZD2		CMHZ5245B	Zener Diode	CMHZ5245B	Central Semiconductor
85	1	ZD3		SZMMBZ5232BLT1G	Zener Diode	SZMMBZ5232BLT1G	onsemi
86	1	ZD4		MMSZ5260BT1G	Zener Diode	MMSZ5260BT1G	onsemi
87	1	ZD5		BZX84-C12,215	Zener Diode	BZX84-C12,215	Nexperia USA
88	0		ZD6,ZD7,ZD8	PDZVTFTR4.3B	Zener Diode	PDZVTFTR4.3B	Rohm Semiconductor
89	1	R69		4.7K/1%/1608	Resistor	RK73H1JTDD4701F	KOA Speer Electronics

---

90	1	U11		PSSI2021SAY,115	IC	PSSI2021SAY,115	Nexperia
----	---	-----	--	-----------------	----	-----------------	----------

Revision History	RL78 Family RTK7RLG240P00000BJ RL78/G24 DC/DC LED Control Evaluation Board User's manual
------------------	---

Rev.	Date	Description	
		Page	Summary
1.00	11 <sup>th</sup> , Sep., 23	—	First Edition issued

---

RL78 Family RTK7RLG240P0000BJ  
RL78/G24 DC/DC LED Control Evaluation Board User's  
Manual  
Publication Date: Rev.1.00 11<sup>th</sup>, Sep., 23

Published by: Renesas Electronics Corporation

---

# RL78 Family

