

RTE0T00020KCAA0000J

Isolator for the E2 Emulator (E2 emulator Lite) of RA/RE

1. Preface

The RTE0T00020KCAA0000J is an isolator for E2 Emulator and E2 emulator Lite.

This product is used for debugging in an environment where there is a GND gap between the user system and the emulator system.

Package Components

Before using this product, please make sure that all the following items are packed.

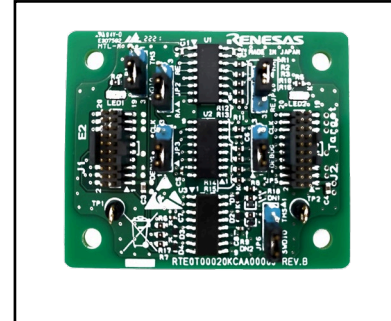

Table 1.1 Package Components

Item	Sermon	Qty.
RTE0T00020KCAA0000J	Isolator for the E2 Emulator (E2 emulator Lite) of RA/RE	1
RTE0T00020KCAC0000J	User interface cable (ARM20P-20Pcable)	1
709441800(Wurth Elektronik)	Nylon Spacer	4
R20UT5065JJ0100	Japanese User's Manual (this material)	1
R20UT5065EJ0100	English User's Manual	1
LLWEB-10018513	List of hazardous toxic substances or elements	1

Note: Please handle this product as precision equipment for transportation.

Important matter

! CAUTION

Caution on Isolation Voltage:



This product is intended to isolate a small and electrically safe GND gap between the user system and emulator system. In any case isolation voltage must be maintained within SELV limits i.e. less than 42.4VAC, or 60VDC.

The isolator must never be used as an element of a safety isolation system. The part could be expected to function correctly at higher voltage across the isolation barrier; but then the circuitry on both sides of the barrier must be regarded as operating at an unsafe voltage and further isolation/insulation systems must form a barrier between these circuits and any user-accessible circuitry according to safety standard requirements.

Caution to Be Taken for Disposal:



Penalties may be applicable for incorrect disposal of this waste, in accordance with your national legislation.

European Union regulatory notices:



The WEEE (Waste Electrical and Electronic Equipment) regulations put responsibilities on producers for the collection and recycling or disposal of electrical and electronic waste. Return of WEEE under these regulations is applicable in the European Union only. This equipment (including all accessories) is not intended for household use. After use the equipment cannot be disposed of as household waste, and the WEEE must be treated, recycled and disposed of in an environmentally sound manner. Renesas Electronics Europe GmbH can take back end of life equipment, register for this service at "<http://www.renesas.eu/weee>".

Cautions to Be Taken for Handling the Isolator:



- Take full care not to touch any parts or cause short circuits on this product.
- Protect this product from excessive physical shock.
- Do not modify this product. Modifying the product will void your warranty.

Cautions for Use Temperature:



The isolator is to be used in an environment with a maximum ambient temperature of 35°C. Care should be taken that this temperature is not exceeded.

CAUTION
Cautions to Be Taken for Connecting the Isolator:

- Always switch OFF the power before connecting or disconnecting this product.
- This product has some switches. Make settings depending on debugging interface you use. Before changing settings power off this product and other connected devices.
- To connect this product to the user system, align the #1 pin of the connector to the right position.
- To connect this product to the emulator, align the #1 pin of the connector to the right position.
- The cable to connect to this product is the same for the user system and the emulator, so check the connection position and connect correctly.

Cautions to Be Taken for Power Supply When Connecting:

- This product needs the power supply from both user system and Emulator.
- Do not change the voltage of the user system after turning on the power.
- When an attempt to connect the emulator debugger to the user system has failed, turn off the user system and then unplug and plug the USB cable of the emulator before trying again.

Cautions to Be Taken for Power Supply When Disconnecting:

- Turn off the power supply of the user system promptly when you disconnect the user system from the emulator debugger. If the power supply of a user system continues being ON, a user program will carry out a reset start. Moreover, you may fail to reconnect the emulator debugger to the user system.
- When an attempt to reconnect to the user system has failed, turn off the user system and then unplug and plug the USB cable of the emulator before trying again.

European Union regulatory notices

This product complies with the following EU Directive.

Environmental Compliance and Certification:

- Waste Electrical and Electronic Equipment (WEEE) Directive 2012/19/EU

2. Specifications

Table 2.1 Product Specifications

Item	Specification	Remarks
Target emulator	1) E2 Emulator 2) E2 emulator Lite	
Power	Requires both of the following two power supplies 1) Supply from the user system. (U_VCC). Voltage: 3.0 V to 5.5 V 2) Supply from the emulator's power supply facility Voltage: 3.3 V	Supply from the user system (U_VCC) needs to be 100 mA (max).
Acceptable GND gap voltage	Less than 42.4 VAC or 60 VDC	
Applicable MCU Families	RA Family RE Family	
Device for isolation	ACSL-6420-00TE (AVAGO) IL260-3E, IL261-3E (NVE)	
LED indication	LED1: Illuminated when power is supplied from the emulator LED2: Illuminated when power is supplied from the user system	This isolator is only usable when both LEDs are illuminated.

3. Notes on Usage

Note on Power-Supply Voltage:

When you use an emulator with this isolator connected, power-supply voltage of the MCU on your system should be between 3.0 V and 5.5 V. Power-supply voltage less than 3.0 V is not supported.
Power-supply voltage less than 3.0 V is not supported.

Note on Signal Delay:

When this product is connected, the communication interface speed may be limited due to the signal delay of the isolation circuit.

Use the e²studio as the debugger.

Set the e²studio communication speed to "AUTO". (The connection speed is optimal.)

The e²studio must be version 2021-10 (21.10.0) or higher.

Note on Programming Software:

Use the Renesas Flash Programmer as the writing software.

If you are unable to start the Renesas Flash Programmer, run e²studio once.

4. Usage

Sections 4.1 to 4.3 of this chapter use the E2 Emulator as an example. If you are using the E2 emulator Lite, read "E2 Emulator" as "E2 emulator Lite". Set the jumper pins according to the usage before connecting. (See Chapter 5)

4.1 Setup

Make sure that the user system and emulator are powered off before installing. Do not connect the USB cable to the emulator.

Connect the emulator to the J1 connector (E2) of this product using the user interface cable.

Connect the user system and the J2 connector (Target) of this product with the user interface cable.

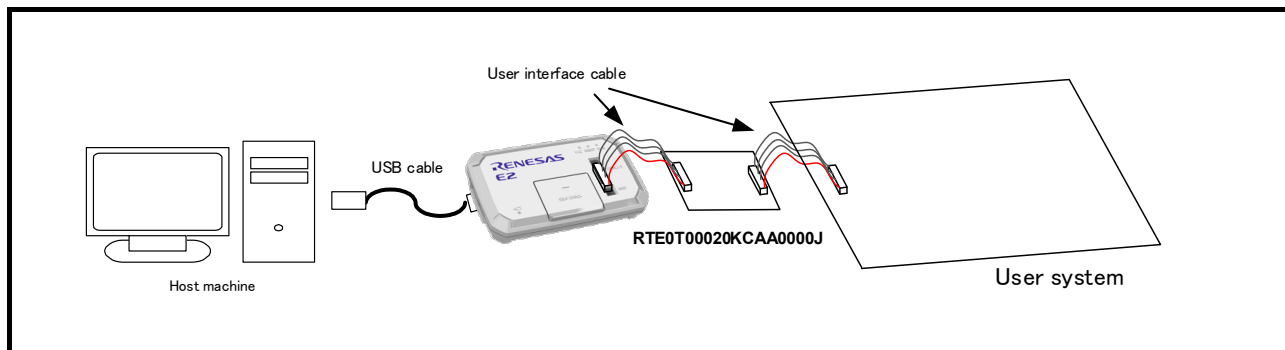

Figure 4.1 RTE0T00020KCAA0000J Installation Method

4.2 Starting the Power Supply

Start the power supply following the procedure below.

(1) **Starting the emulator power supply**

Connect the USB cable between the host machine and the E2 Emulator. E2 Emulator power is supplied.

(2) **User System Power Up**

User System Power Up Power is supplied to this product from the J2-1 terminal.

(3) **Debugger startup (power supply setting)**

Start the debugger from the control PC, and set the power supply to the target device to ON in the initial setting screen. Select 3.3V for supply voltage regardless of the voltage used for the user system.

Refer to the user's manual for your emulator (E2 Emulator or E2 emulator Lite) for the following settings.

4.3 Shutdown the Power Supply

- (1) **Shut down user system power**
Shut down the power supply of the user system.
- (2) **Shut down the power supply of the emulator**
Disconnect the USB cable between the host machine and the E2 Emulator to turn off the E2 Emulator power.

5. Jumper Pins (JP1 - JP6) Settings

The jumper pin settings differ depending on the software used. If you are using the debugger (e2studio), see Section 5.1. If you are using the Renesas Flash Programmer, see Section 5.2.

5.1 Settings when using the debugger (e²studio)

Set the jumper pins (JP1 - JP6) of this product according to the settings of the debugger (e2studio).

When the setting of (2) in Figure 5.1 is **JTAG**, set the jumper pins (JP1 - JP6) of this product according to **JTAG** in Table 5.1.

When the setting of (2) in Figure 5.1 is **SWD**, set the jumper pin (JP1 - JP6) of this product according to the **SWD** in Table 5.1.

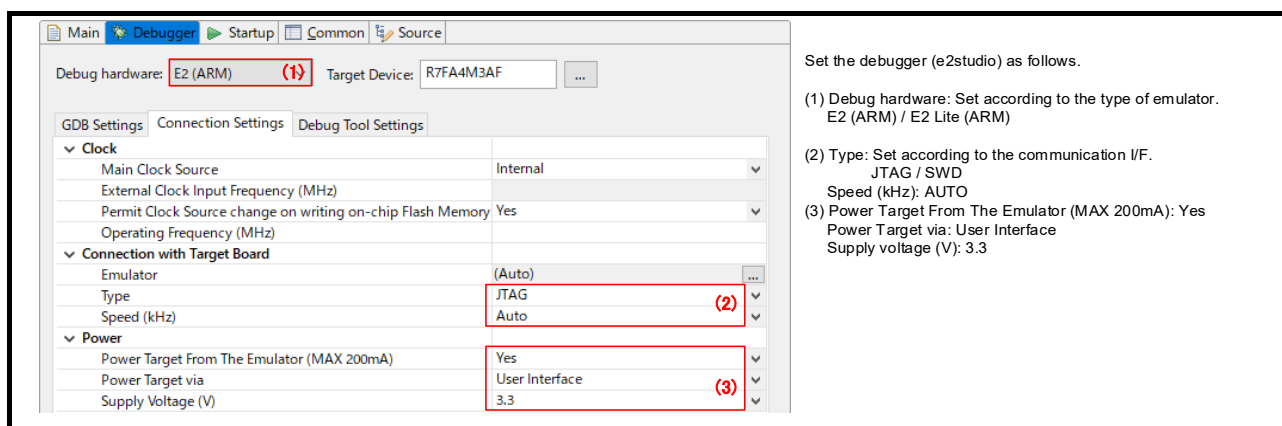

Figure 5.1 Debugger (e² studio) settings

Table 5.1 Jumper pin (JP1 - JP6) settings when using the debugger (e² studio)

JTAG		SWD	
	JP1, JP6: 1-2 (TMS)		JP1, JP6: 2-3 (SWDIO)
	JP2, JP4: 1-2 (RA)		JP2, JP4: 1-2 (RA)
JP3, JP5: 1-2 (DEBUG)	JP3, JP5: 1-2 (DEBUG)		JP3, JP5: 1-2 (DEBUG)

5.2 Settings when using Renesas Flash Programmer (Programming GUI)

Set the jumper pins (JP1 - JP6) of this product according to the settings of the Renesas Flash Programmer. When (1) in Figure 5.2 is RA, set the jumper pins (JP1 - JP6) of this product according to RA in Table 5.2. When (1) in Figure 5.2 is RE, set the jumper pins (JP1 - JP6) of this product according to RE in Table 5.2. Set "Power Supply" to 3.3V from [Tool Details] dialog box on the [Connect Settings] tab.

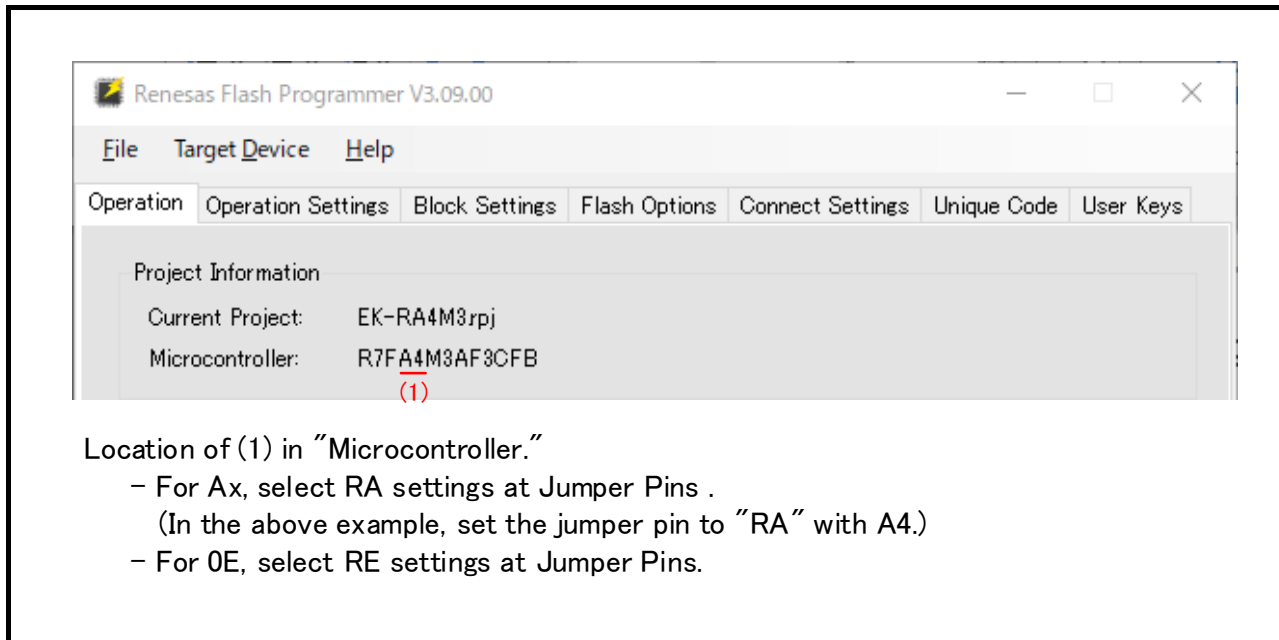
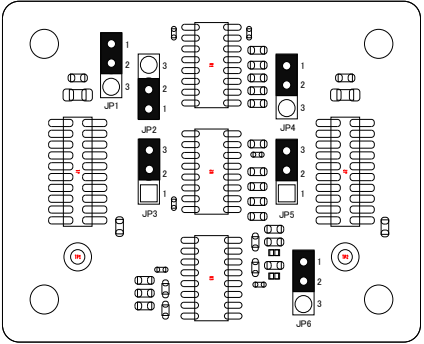
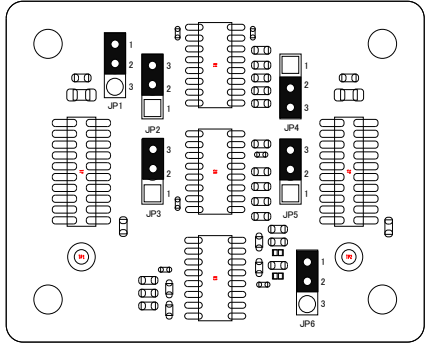

Figure 5.2 Configuring Renesas Flash Programmer

Table 5.2 Jumper Pins (JP1 - JP6) Settings for Renesas Flash Programmer

RA		RE	
	<p>JP1, JP6: 1-2 (TMS)</p> <p>JP2, JP4: 1-2 (RA)</p> <p>JP3, JP5: 2-3 (CLK)</p>		<p>JP1, JP6: 1-2 (TMS)</p> <p>JP2, JP4: 2-3 (RE)</p> <p>JP3, JP5: 2-3 (CLK)</p>

6. External Dimensions

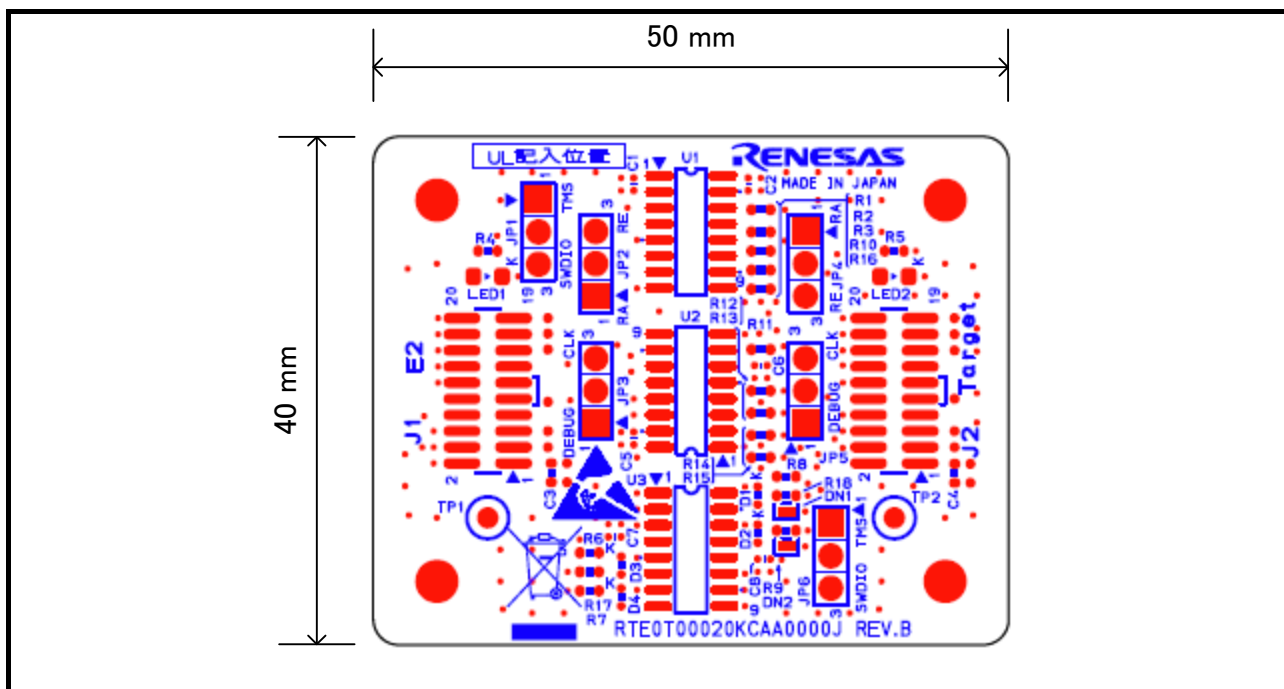

Figure 6.1 External Dimensions

7. Warranty

This product comes with a one-year warranty after purchase.

- (1) Should the product break down or be damaged while you're using it under normal condition based on its user's manual, it will be replaced free of cost.
- (2) However, if the following failure or damage occurs to the product under warranty, the product will be replaced at cost.
 - a) Failure or damage attributable to the misuse or abuse of the product or its use under other abnormal conditions.
 - b) Failure or damage attributable to improper handling of the product after purchase, such as dropping of the product when it is transported or moved.
 - c) Failure or damage to the product caused by other pieces of equipment connected to it.
 - d) Failure or damage attributable to fire, earthquakes, thunderbolts, floods, or other natural disasters or abnormal voltages, etc.
 - e) Failure or damage attributable to modifications, repairs, adjustments, or other acts made to the product by other than Renesas Electronics Corporation.
- (3) This product is accessories product. We cannot accept any request for repair. Please forgive the request for repair.

Precautions

This product is only intended for use in a laboratory environment under ambient temperature and humidity conditions. A safe separation distance should be used between this and any sensitive equipment. Its use outside the laboratory, classroom, study area or similar such area invalidates conformity with the protection requirements of the Electromagnetic Compatibility Directive and could lead to prosecution.

The product generates, uses, and can radiate radio frequency energy and may cause harmful interference to radio communications. However, there is no guarantee that interference will not occur in a particular installation. If this equipment causes harmful interference to radio or television reception, which can be determined by turning the equipment off or on, you are encouraged to try to correct the interference by one or more of the following measures;

- ensure attached cables do not lie across the equipment
- reorient the receiving antenna
- increase the distance between the equipment and the receiver
- connect the equipment into an outlet on a circuit different from that which the receiver is connected
- power down the equipment when not in use
- consult the dealer or an experienced radio/TV technician for help

NOTE: It is recommended that wherever possible shielded interface cables are used.

The product is potentially susceptible to certain EMC phenomena. To mitigate against them it is recommended that the following measures be undertaken;

- The user is advised that mobile phones should not be used within 10m of the product when in use.
- The user is advised to take ESD precautions when handling the equipment.

This product does not represent an ideal reference design for an end product and does not fulfil the regulatory standards for an end product.

Notice

1. Descriptions of circuits, software and other related information in this document are provided only to illustrate the operation of semiconductor products and application examples. You are fully responsible for the incorporation or any other use of the circuits, software, and information in the design of your product or system. Renesas Electronics disclaims any and all liability for any losses and damages incurred by you or third parties arising from the use of these circuits, software, or information.
2. Renesas Electronics hereby expressly disclaims any warranties against and liability for infringement or any other claims involving patents, copyrights, or other intellectual property rights of third parties, by or arising from the use of Renesas Electronics products or technical information described in this document, including but not limited to, the product data, drawings, charts, programs, algorithms, and application examples.
3. No license, express, implied or otherwise, is granted hereby under any patents, copyrights or other intellectual property rights of Renesas Electronics or others.
4. You shall be responsible for determining what licenses are required from any third parties, and obtaining such licenses for the lawful import, export, manufacture, sales, utilization, distribution or other disposal of any products incorporating Renesas Electronics products, if required.
5. You shall not alter, modify, copy, or reverse engineer any Renesas Electronics product, whether in whole or in part. Renesas Electronics disclaims any and all liability for any losses or damages incurred by you or third parties arising from such alteration, modification, copying or reverse engineering.
6. Renesas Electronics products are classified according to the following two quality grades: "Standard" and "High Quality". The intended applications for each Renesas Electronics product depends on the product's quality grade, as indicated below.
 - "Standard": Computers; office equipment; communications equipment; test and measurement equipment; audio and visual equipment; home electronic appliances; machine tools; personal electronic equipment; industrial robots; etc.
 - "High Quality": Transportation equipment (automobiles, trains, ships, etc.); traffic control (traffic lights); large-scale communication equipment; key financial terminal systems; safety control equipment; etc.
- Unless expressly designated as a high reliability product or a product for harsh environments in a Renesas Electronics data sheet or other Renesas Electronics document, Renesas Electronics products are not intended or authorized for use in products or systems that may pose a direct threat to human life or bodily injury (artificial life support devices or systems; surgical implantations; etc.), or may cause serious property damage (space system; undersea repeaters; nuclear power control systems; aircraft control systems; key plant systems; military equipment; etc.). Renesas Electronics disclaims any and all liability for any damages or losses incurred by you or any third parties arising from the use of any Renesas Electronics product that is inconsistent with any Renesas Electronics data sheet, user's manual or other Renesas Electronics document.
7. No semiconductor product is absolutely secure. Notwithstanding any security measures or features that may be implemented in Renesas Electronics hardware or software products, Renesas Electronics shall have absolutely no liability arising out of any vulnerability or security breach, including but not limited to any unauthorized access to or use of a Renesas Electronics product or a system that uses a Renesas Electronics product. RENESAS ELECTRONICS DOES NOT WARRANT OR GUARANTEE THAT RENESAS ELECTRONICS PRODUCTS, OR ANY SYSTEMS CREATED USING RENESAS ELECTRONICS PRODUCTS WILL BE INVULNERABLE OR FREE FROM CORRUPTION, ATTACK, VIRUSES, INTERFERENCE, HACKING, DATA LOSS OR THEFT, OR OTHER SECURITY INTRUSION ("Vulnerability Issues"). RENESAS ELECTRONICS DISCLAIMS ANY AND ALL RESPONSIBILITY OR LIABILITY ARISING FROM OR RELATED TO ANY VULNERABILITY ISSUES. FURTHERMORE, TO THE EXTENT PERMITTED BY APPLICABLE LAW, RENESAS ELECTRONICS DISCLAIMS ANY AND ALL WARRANTIES, EXPRESS OR IMPLIED, WITH RESPECT TO THIS DOCUMENT AND ANY RELATED OR ACCOMPANYING SOFTWARE OR HARDWARE, INCLUDING BUT NOT LIMITED TO THE IMPLIED WARRANTIES OF MERCHANTABILITY, OR FITNESS FOR A PARTICULAR PURPOSE.
8. When using Renesas Electronics products, refer to the latest product information (data sheets, user's manuals, application notes, "General Notes for Handling and Using Semiconductor Devices" in the reliability handbook, etc.), and ensure that usage conditions are within the ranges specified by Renesas Electronics with respect to maximum ratings, operating power supply voltage range, heat dissipation characteristics, installation, etc. Renesas Electronics disclaims any and all liability for any malfunctions, failure or accident arising out of the use of Renesas Electronics products outside of such specified ranges.
9. Although Renesas Electronics endeavors to improve the quality and reliability of Renesas Electronics products, semiconductor products have specific characteristics, such as the occurrence of failure at a certain rate and malfunctions under certain use conditions. Unless designated as a high reliability product or a product for harsh environments in a Renesas Electronics data sheet or other Renesas Electronics document, Renesas Electronics products are not subject to radiation resistance design. You are responsible for implementing safety measures to guard against the possibility of bodily injury, injury or damage caused by fire, and/or danger to the public in the event of a failure or malfunction of Renesas Electronics products, such as safety design for hardware and software, including but not limited to redundancy, fire control and malfunction prevention, appropriate treatment for aging degradation or any other appropriate measures. Because the evaluation of microcomputer software alone is very difficult and impractical, you are responsible for evaluating the safety of the final products or systems manufactured by you.
10. Please contact a Renesas Electronics sales office for details as to environmental matters such as the environmental compatibility of each Renesas Electronics product. You are responsible for carefully and sufficiently investigating applicable laws and regulations that regulate the inclusion or use of controlled substances, including without limitation, the EU RoHS Directive, and using Renesas Electronics products in compliance with all these applicable laws and regulations. Renesas Electronics disclaims any and all liability for damages or losses occurring as a result of your noncompliance with applicable laws and regulations.
11. Renesas Electronics products and technologies shall not be used for or incorporated into any products or systems whose manufacture, use, or sale is prohibited under any applicable domestic or foreign laws or regulations. You shall comply with any applicable export control laws and regulations promulgated and administered by the governments of any countries asserting jurisdiction over the parties or transactions.
12. It is the responsibility of the buyer or distributor of Renesas Electronics products, or any other party who distributes, disposes of, or otherwise sells or transfers the product to a third party, to notify such third party in advance of the contents and conditions set forth in this document.
13. This document shall not be reprinted, reproduced or duplicated in any form, in whole or in part, without prior written consent of Renesas Electronics.
14. Please contact a Renesas Electronics sales office if you have any questions regarding the information contained in this document or Renesas Electronics products.

(Note1) "Renesas Electronics" as used in this document means Renesas Electronics Corporation and also includes its directly or indirectly controlled subsidiaries.

(Note2) "Renesas Electronics product(s)" means any product developed or manufactured by or for Renesas Electronics.

(Rev.5.0-1 October 2020)

Corporate Headquarters

TOYOSU FORESIA, 3-2-24 Toyosu,
Koto-ku, Tokyo 135-0061, Japan
www.renesas.com

Trademarks

Renesas and the Renesas logo are trademarks of Renesas Electronics Corporation. All trademarks and registered trademarks are the property of their respective owners.

Contact information

For further information on a product, technology, the most up-to-date version of a document, or your nearest sales office, please visit:
www.renesas.com/contact/.