

RTKA211450DE0000BU

The RTKA211450DE0000BU board evaluates the [RAA211450](#) (QFN version), a DC/DC synchronous step-down regulator with programmable switching frequency.

The RAA211450 supports a wide input voltage range (from 4.5V to 42V) and adjustable output voltage. It delivers up to a continuous 3A output current with premium load regulation and line regulation performance.

Features

- Simple and flexible design
- 4.5V to 42V V_{IN} range
- Convenient power conversion

Specifications

The following are the design specifications for the RTKA211450DE0000BU:

- Input voltage (V_{IN}): 4.5V to 42V
- Output voltage (V_{OUT}): 3.3V
- Maximum output current: 5A

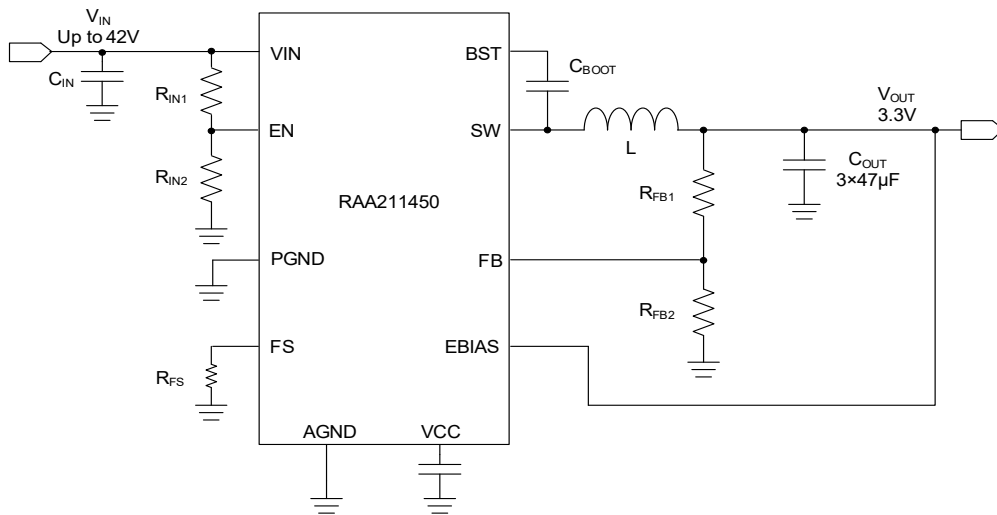

Figure 1. Simplified Circuit

Contents

1. Functional Description	3
1.1 Operational Characteristics	3
1.2 Setup and Configuration	3
2. Board Design	4
2.1 Layout Guidelines	4
2.2 Schematic Diagram	5
2.3 Bill of Materials	6
2.4 Board Layout	7
3. Typical Performance Graphs	9
4. Ordering Information	10
5. Revision History	10

1. Functional Description

The RAA211450 (QFN version) is an easy-to-use synchronous Buck switching regulator with integrated 70mΩ (high-side) and 30mΩ (low-side) MOSFETs. The RTKA211450DE0000BU board evaluates the operations of RAA211450 (QFN version). The board allows you to evaluate the performance of the part with different application circuits, and it provides a reference for the board layout.

The manual includes a schematic (Figure 4), PCB layers (Figure 5 to Figure 8), performance data and waveforms taken from the evaluation board (Figure 9 to Figure 16), and a full list of materials (Bill of Materials).

1.1 Operational Characteristics

The board input voltage range is from 4.5V to 42V. The output voltage is set to 3.3V by default and can be changed by R₉ and R₁₀, as shown in Equation 1:

$$(EQ. 1) \quad R_9 = R_{10} \cdot \frac{V_{out} - 0.8}{0.8}$$

Renesas recommends using a 20kΩ resistor for R₁₀ and choose R₉ based on Equation 1.

1.2 Setup and Configuration

1. Populate a jumper on JP1(VIN shorted to EN).
2. Connect the power supply to the input terminals VIN(T1) and GND(T2). Connect the load to the output terminals VOUT(T3) and GND(T4). Make sure the setup is correctly connected before applying any power or load to the board.
3. Turn on the power supply and the part should start operating.
4. Verify that the output voltage is 3.3V and phase node waveforms can be monitored at J1.

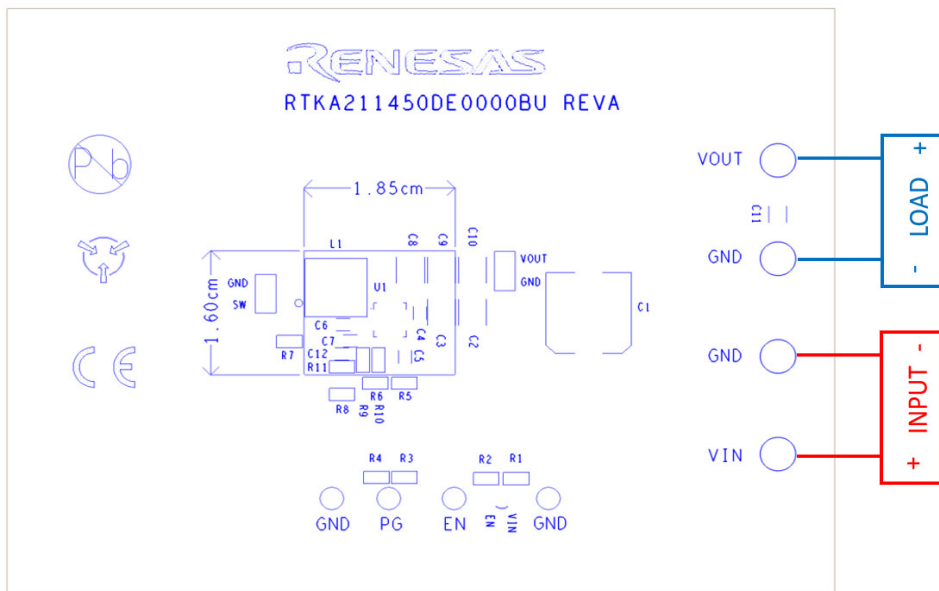

Figure 2. RTKA211450DE0000BU Board Setup

2. Board Design

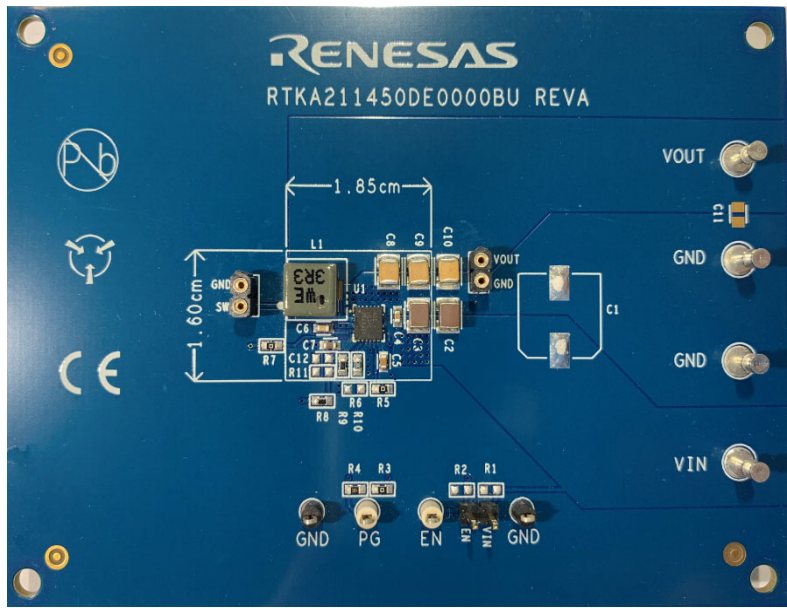

Figure 3. RTKA211450DE0000BU Evaluation Board (Top)

2.1 Layout Guidelines

For detailed layout guidelines reference the Layout Guidelines section in the *RAA211450 Datasheet*.

2.2 Schematic Diagram

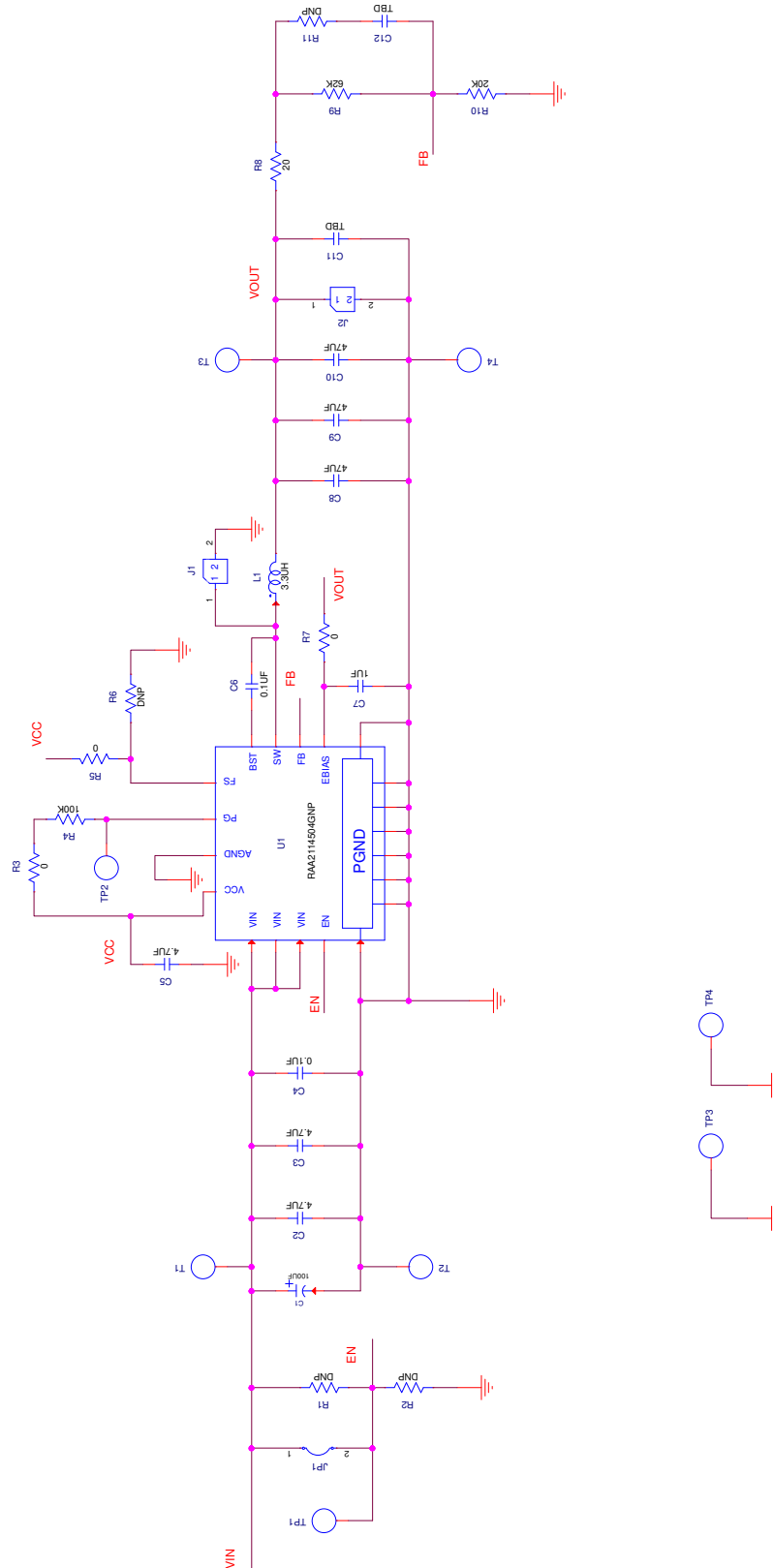

Figure 4. RTKA211450DE000BU Schematic

2.3 Bill of Materials

Qty	Ref Des	Description	Manufacturer	Part Number
3	C8, C9, C10	CAP, SMD, 1210, 47 μ F, 10V, 10%, X7R, ROHS	Murata	GRM32ER71A476KE15L
1	C7	CAP, SMD, 0603, 1.0 μ F, 16V, 10%, X7R, ROHS	TDK	C1608X7R1C105K
1	C6	CAP, SMD, 0603, 0.1 μ F, 16V, 10%, X7R, ROHS	Murata	GCM188R71C104KA37D
1	C5	CAP, SMD, 0603, 4.7 μ F, 10V, 10%, X7S, ROHS	Murata	GRM188C71A475KE11D
1	C4	CAP, SMD, 0402, 0.1 μ F, 50V, 10%, X5R, ROHS	TDK	CGA2B3X5R1H104K050BB
2	C2, C3	CAP, SMD, 1206, 10 μ F, 50V, 10%, X5R, ROHS	TDK	C3216X5R1H106K
1	L1	COIL-PWR Inductor, SMD, 6.6mmx6.4mm, 6.8 μ H, 20%, 6.5A, ROHS	Würth Electronics	74439344033
4	T1, T2, T3, T4	CONN-DBL TURRET, TH, 0.218x0.078 PCB MNT, TIN/BRASS, ROHS	Keystone	1502-1
2	J1, J2	CONN-BRD-BRD, 1x2, TH, Socket, 1x64 STRIP, 2.54mm, ST	Mill-max	310-43-164-41-001000
1	TP3, TP4	CONN-MINI TEST POINT, Vertical, Blk, ROHS	Keystone	5001
1	TP1, TP2	CONN-MINI TEST POINT, Vertical, White, ROHS	Keystone	5002
1	JP1	CONN-HEADER, 1x2, Retentive, 2.54mm, 0.230x 0.120, ROHS	BERG/FCI	69190-202HLF
1	R10	RES, SMD, 0603, 20k Ω , 1/10W, 1%, ROHS	Various	Generic
1	R9	RES, SMD, 0603, 62k Ω , 1/10W, 1%, ROHS	Panasonic	ERJ-3EKF6202V
1	R8	RES, SMD, 0603, 20 Ω , 1/10W, 1%, ROHS	Panasonic	ERJ-3EKF20R0V
3	R3, R5, R7	RES, SMD, 0603, 0 Ω , 1/10W, ROHS	Various	Generic
1	R4	RES, SMD, 0603, 100k Ω , 1/10W, 1%, ROHS	Various	Generic
1	U1	IC-5A DC/DC Step Down Regulator, 20P, QFN, ROHS	Renesas	RAA211450GNP#HA0
0	C1	CAP, SMD, 12x10, 47 μ F, 100V, 20%, Alum.Elec., ROHS	Vishay	MAL214699904E3
0	C11, C12, R1, R2, R6, R11	DO NOT POPULATE	N/A	N/A

2.4 Board Layout

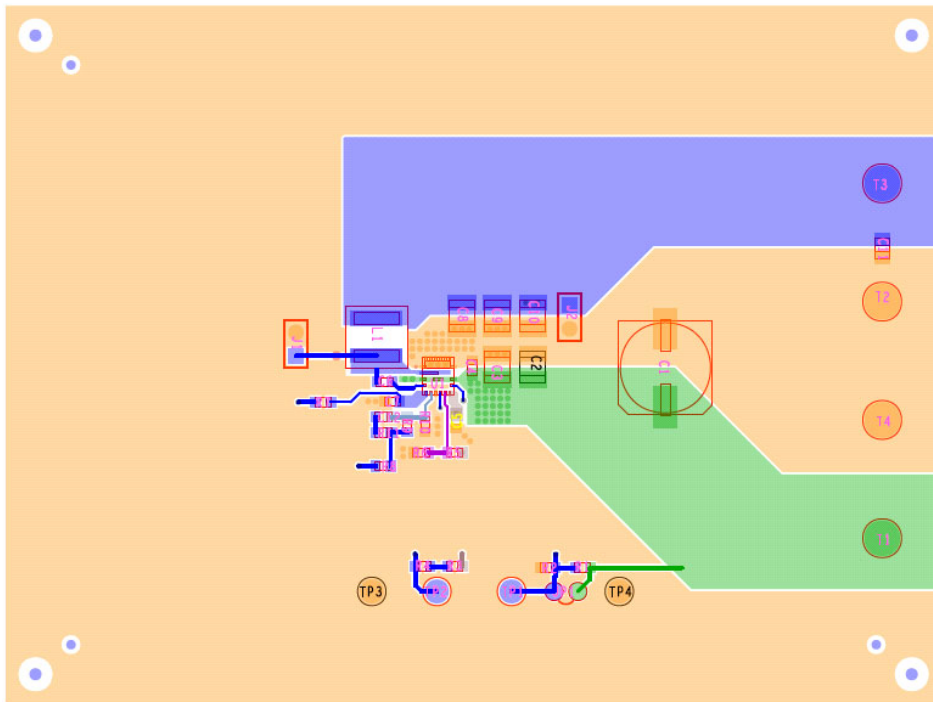

Figure 5. Top Layer

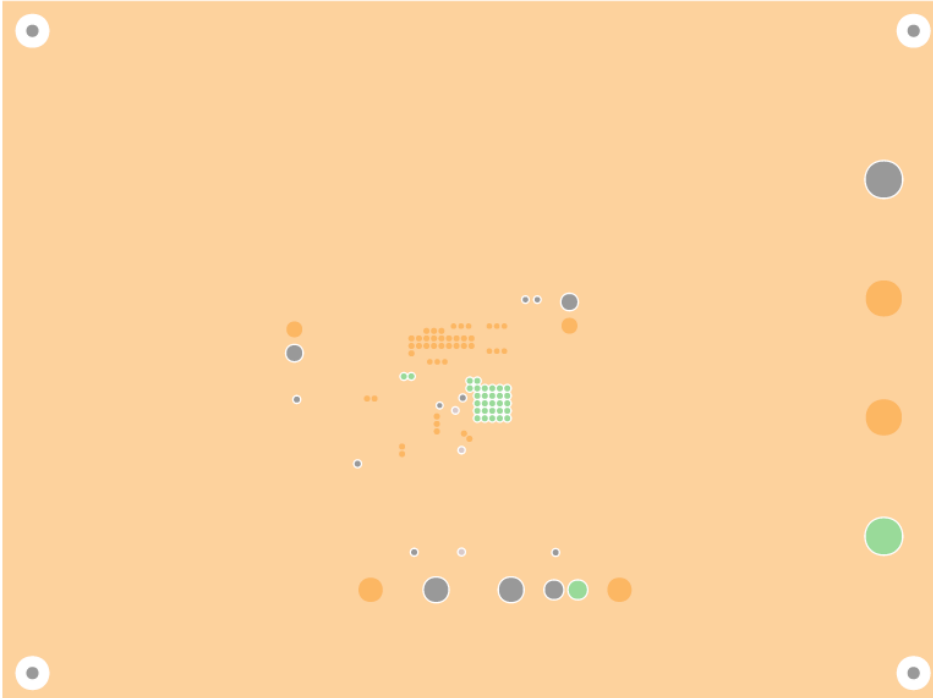

Figure 6. Second Layer

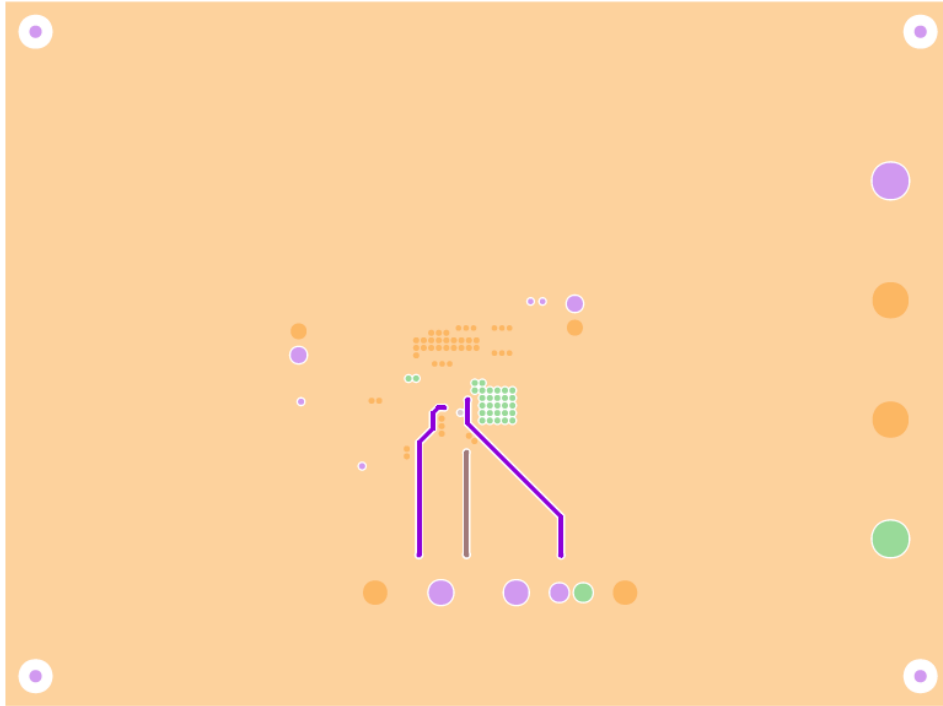

Figure 7. Third Layer

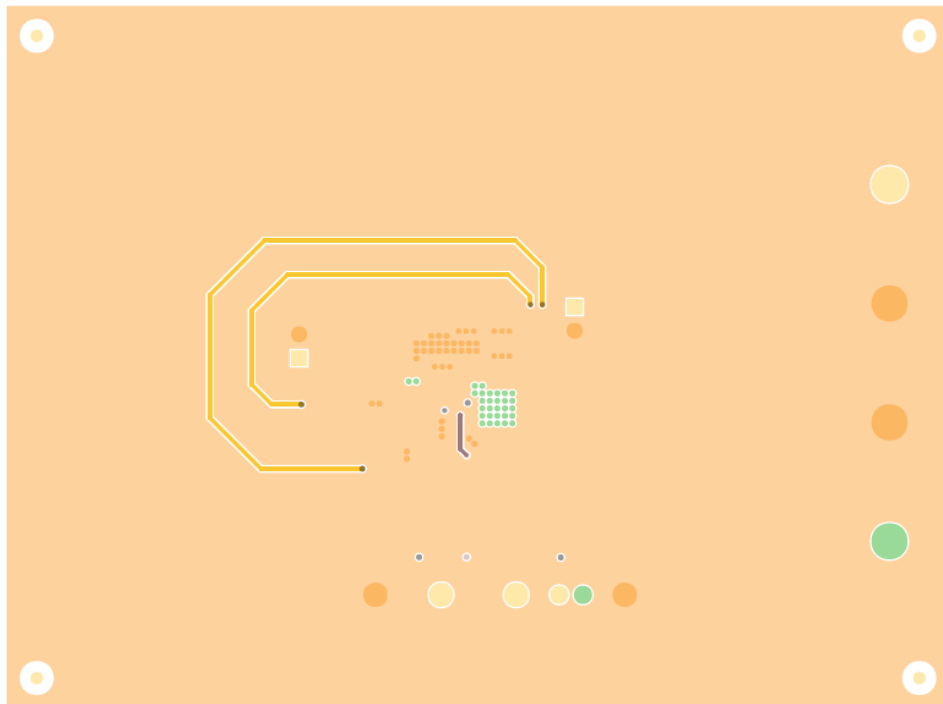

Figure 8. Bottom Layer

3. Typical Performance Graphs

$V_{IN} = 24V$, $V_{OUT} = 3.3V$, $T_A = +25^{\circ}C$, unless otherwise noted.

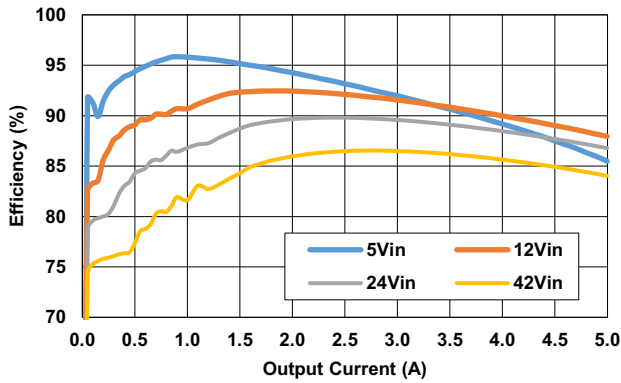

Figure 9. Efficiency vs Load

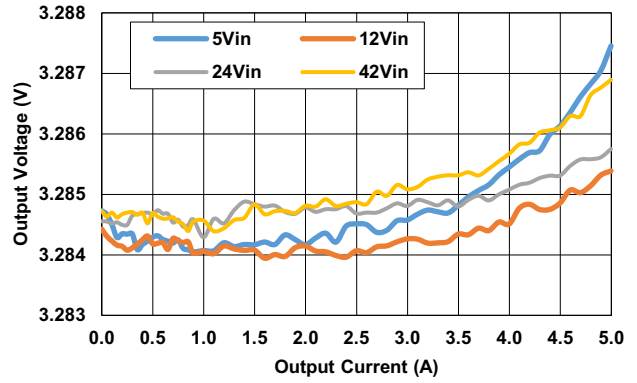

Figure 10. Load Regulation

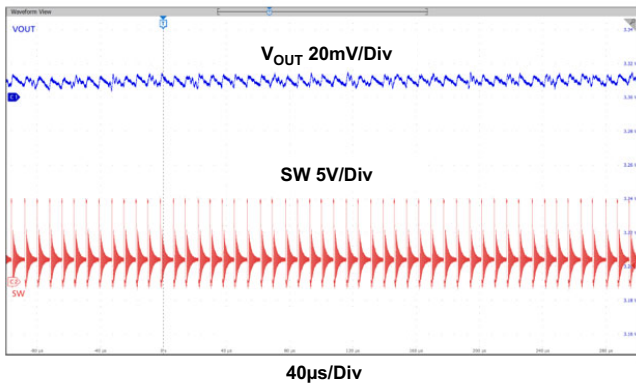

Figure 11. Output Ripple at No Load

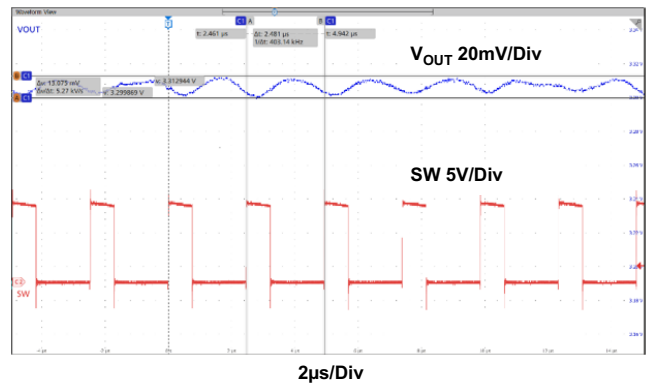

Figure 12. Output Ripple at Full Load

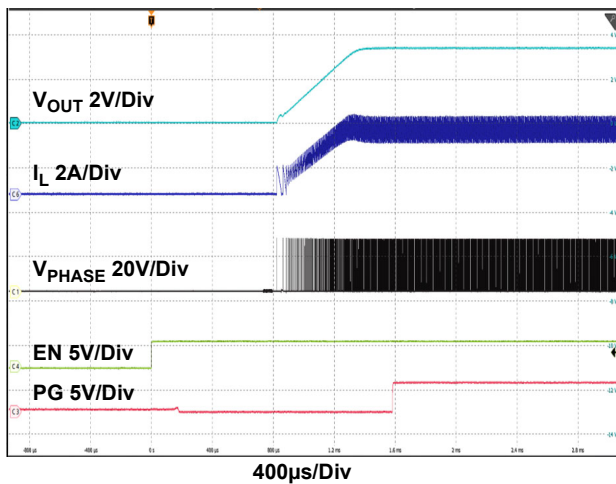

Figure 13. Enable On at Full Load with Internal SS

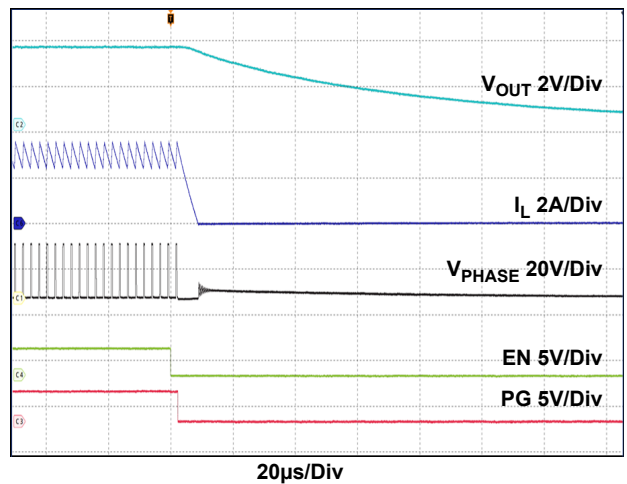

Figure 14. Enable Off at Full Load with Internal SS

$V_{IN} = 24V$, $V_{OUT} = 3.3V$, $T_A = +25^{\circ}C$, unless otherwise noted. (Cont.)

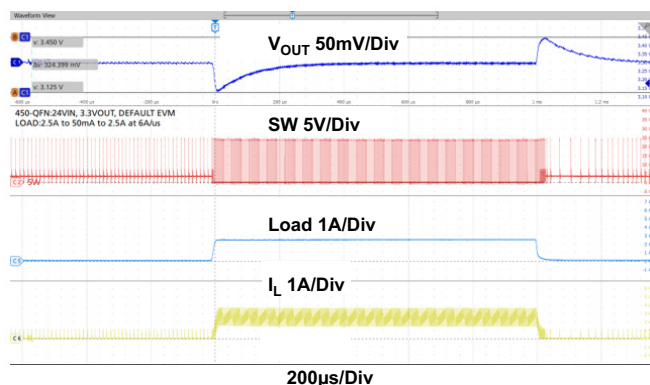

Figure 15. Load Ramp from 50mA to 2.5A

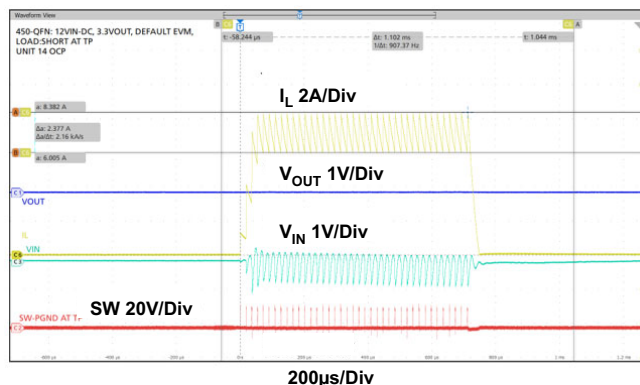

Figure 16. OCP by Short V_{OUT}

4. Ordering Information

Part Number	Description
RTKA211450DE0000BU	RAA211450 Evaluation Board - QFN Version

5. Revision History

Revision	Date	Description
1.01	Oct 7, 2022	Updated Figure 1.
1.00	May 5, 2022	Initial release

IMPORTANT NOTICE AND DISCLAIMER

RENESAS ELECTRONICS CORPORATION AND ITS SUBSIDIARIES (“RENESAS”) PROVIDES TECHNICAL SPECIFICATIONS AND RELIABILITY DATA (INCLUDING DATASHEETS), DESIGN RESOURCES (INCLUDING REFERENCE DESIGNS), APPLICATION OR OTHER DESIGN ADVICE, WEB TOOLS, SAFETY INFORMATION, AND OTHER RESOURCES “AS IS” AND WITH ALL FAULTS, AND DISCLAIMS ALL WARRANTIES, EXPRESS OR IMPLIED, INCLUDING, WITHOUT LIMITATION, ANY IMPLIED WARRANTIES OF MERCHANTABILITY, FITNESS FOR A PARTICULAR PURPOSE, OR NON-INFRINGEMENT OF THIRD PARTY INTELLECTUAL PROPERTY RIGHTS.

These resources are intended for developers skilled in the art designing with Renesas products. You are solely responsible for (1) selecting the appropriate products for your application, (2) designing, validating, and testing your application, and (3) ensuring your application meets applicable standards, and any other safety, security, or other requirements. These resources are subject to change without notice. Renesas grants you permission to use these resources only for development of an application that uses Renesas products. Other reproduction or use of these resources is strictly prohibited. No license is granted to any other Renesas intellectual property or to any third party intellectual property. Renesas disclaims responsibility for, and you will fully indemnify Renesas and its representatives against, any claims, damages, costs, losses, or liabilities arising out of your use of these resources. Renesas' products are provided only subject to Renesas' Terms and Conditions of Sale or other applicable terms agreed to in writing. No use of any Renesas resources expands or otherwise alters any applicable warranties or warranty disclaimers for these products.

(Rev.1.0 Mar 2020)

Corporate Headquarters

TOYOSU FORESIA, 3-2-24 Toyosu,
Koto-ku, Tokyo 135-0061, Japan
www.renesas.com

Contact Information

For further information on a product, technology, the most up-to-date version of a document, or your nearest sales office, please visit:
www.renesas.com/contact/

Trademarks

Renesas and the Renesas logo are trademarks of Renesas Electronics Corporation. All trademarks and registered trademarks are the property of their respective owners.