

RTKA211835DE0010BU

The RTKA211835DE0010BU board demonstrates and quickly evaluates the [RAA211835](#) (HTSSOP version), a DC/DC asynchronous step-down regulator with programmable switching frequency.

The RAA211835 supports a wide input voltage range (from 4.5V to 75V) and adjustable output voltage. It can deliver up to continuous 3A output current with premium load regulation and line regulation performance.

Features

- Simple and flexible design
- 4.5V to 75V V_{IN} range
- Convenient power conversion

Specifications

The design specifications of the RTKA211835DE0010BU are shown below:

- Input voltage (V_{IN}): 4.5V to 75V
- Output voltage (V_{OUT}): 3.3V
- Maximum output current: 3A

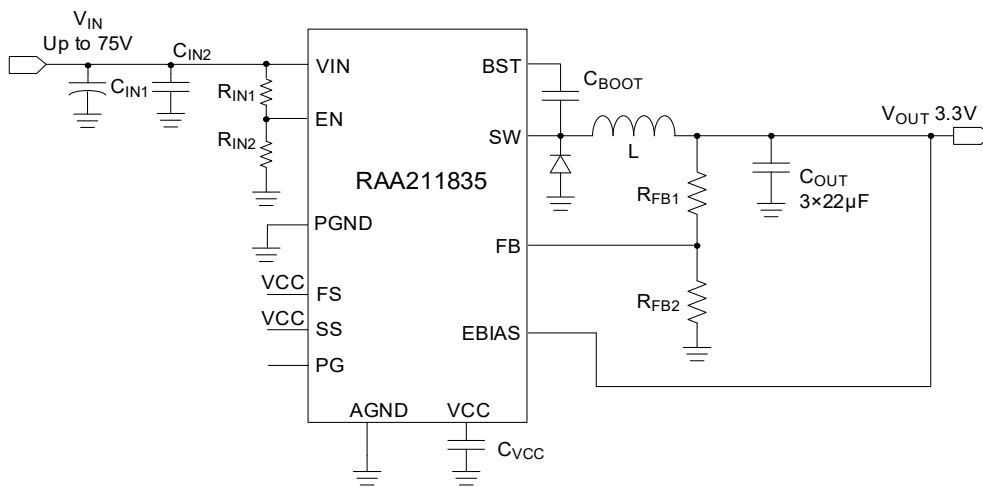

Figure 1. RAA211835 Typical Application

Contents

1. Functional Description	3
1.1 Operational Characteristics	3
1.2 Setup and Configuration	3
2. Board Design	4
2.1 Layout Guidelines	4
2.2 Schematic Diagrams	5
2.3 Bill of Materials	6
2.4 Board Layout	7
3. Typical Performance Graphs	9
4. Ordering Information	11
5. Revision History	11

2. Board Design

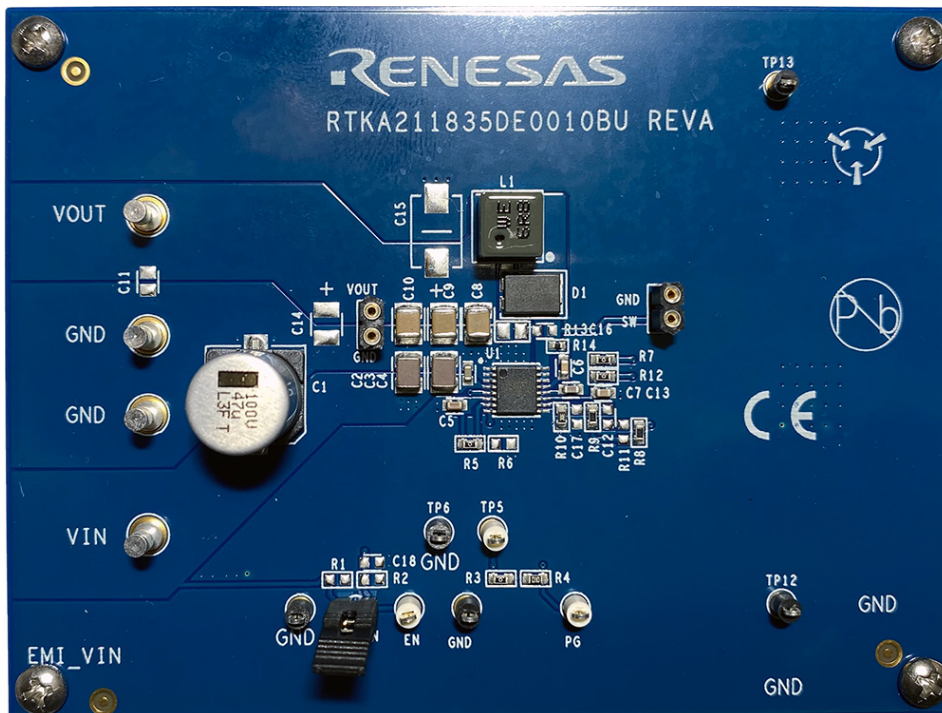

Figure 3. RTKA211835DE0010BU Evaluation Board (Top)

2.1 Layout Guidelines

For detailed layout guidelines reference the Layout Guidelines section in the *RAA211835 Datasheet*.

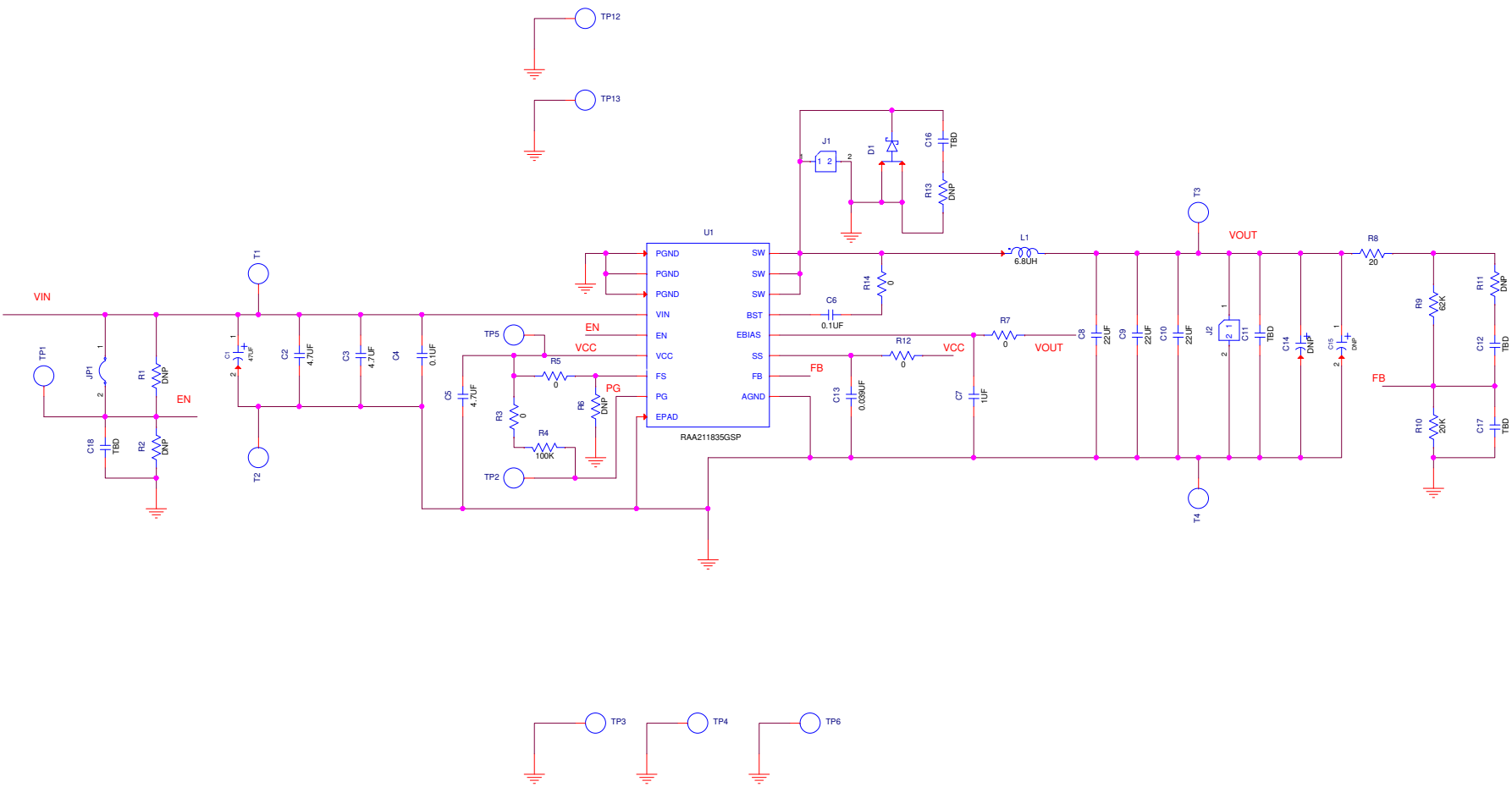

Figure 4. RTKA211835DE0010BU Schematic

2.2 Schematic Diagrams

2.3 Bill of Materials

Qty	Reference Designator	Description	Manufacturer	Manufacturer Part Number
3	C8, C9, C10	CAP, SMD, 1210, 22 μ F, 16V, 10%, X7R, ROHS	Murata	GRM32ER71C226KE18L
1	C7	CAP, SMD, 0603, 1.0 μ F, 16V, 10%, X7R, ROHS	TDK	C1608X7R1C105K
1	C6	CAP, SMD, 0603, 0.1 μ F, 16V, 10%, X7R, ROHS	Murata	GCM188R71C104KA37D
1	C5	CAP, SMD, 0603, 4.7 μ F, 10V, 10%, X7S, ROHS	Murata	GRM188C71A475KE11D
1	C4	CAP, SMD, 0603, 0.1 μ F, 100V, 10%, X7R, ROHS	Murata	GRM188R72A104KA35J
2	C2, C3	CAP-AEC-Q200, SMD, 1210, 4.7 μ F, 100V, 10%, X7R, ROHS	TDK	CNA6P1X7R2A475K250AE
1	C13	CAP, SMD, 0603, 0.039 μ F, 25V, 10%, X7R, ROHS	Panasonic	ECJ-1VB1E393K
1	L1	COIL-PWR INDUCTOR, SMD, 6.6x6.4mm, 6.8 μ H, 20%, 6.5A, ROHS	Würth Electronics	74439346068
4	T1, T2, T3, T4	CONN-DBL TURRET, TH, 0.218x0.078 PCB MNT, TIN/BRASS, ROHS	Keystone	1502-1
2	J1, J2	CONN-BRD-BRD, 1x2, TH, SOCKET, 1x64 STRIP, 2.54mm, ST	Mill-Max	310-43-164-41-001000
5	TP3, TP4, TP6, TP12, TP13	CONN-MINI TEST PT, VERTICAL, BLK, ROHS	Keystone	5001
3	TP1, TP2, TP5	CONN-MINI TEST POINT, VERTICAL, WHITE, ROHS	Keystone	5002
1	JP1	CONN-HEADER, 1x2, RETENTIVE, 2.54mm, 0.230x0.120, ROHS	Berg/FCI	69190-202HLF
1	R10	RES, SMD, 0603, 20k Ω , 1/10W, 1%, TF, ROHS	Various	VARIOUS
1	R9	RES-AEC-Q200, SMD, 0603, 62K, 1/10W, 1%, ROHS	Panasonic	ERJ-3EKF6202V
1	R8	RES-AEC-Q200, SMD, 0603, 20 Ω , 1/10W, 1%, TF, ROHS	Panasonic	ERJ-3EKF20R0V
4	R3, R5, R7, R12	RES, SMD, 0603, 0 Ω , 1/10W, TF, ROHS	Various	VARIOUS
1	R14	RES, SMD, 0402, 0 Ω , 1/10W, TF, ROHS	Various	VARIOUS
1	R4	RES, SMD, 0603, 100k Ω , 1/10W, 1%, TF, ROHS	Various	VARIOUS
1	U1	IC-75V 3A PWM SWITCHING REGULATOR, 16P, HTSSOP, ROHS	Renesas	RAA211835GSP#HA0
1	C1	CAP, SMD, 12x10, 47 μ F, 100V, 20%, ALUM.ELEC., ROHS	Vishay	MAL214699904E3
1	D1	DIODE SCHOTTKY 100V 10A TO277-3	OnSemi	FSV10100V
0	C11, C12, C14, C15, C16, C17, C18, R1, R2, R6, R11, R13	Do Not Populate	N/A	N/A

2.4 Board Layout

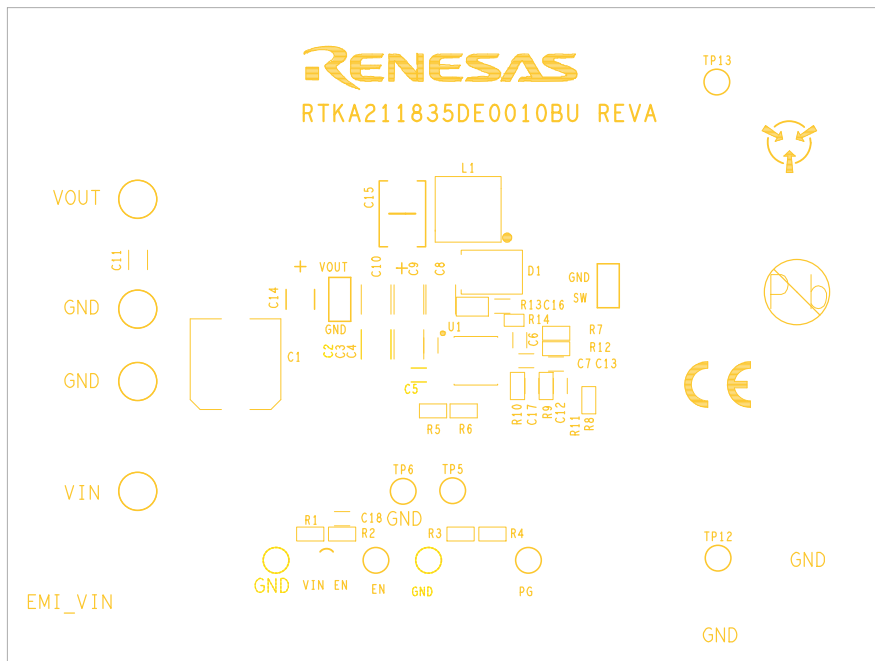

Figure 5. Silkscreen Top Layer

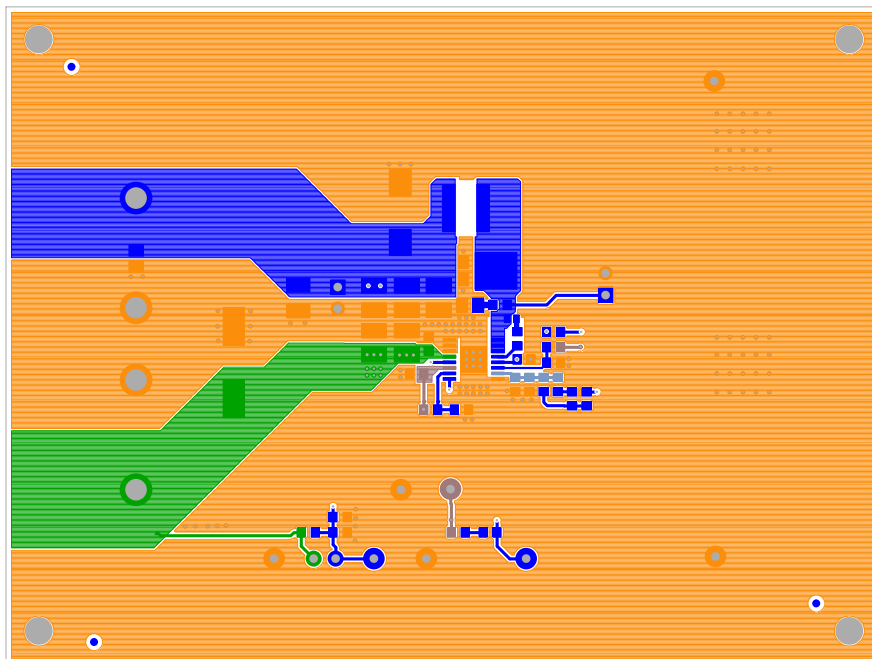

Figure 6. Top Layer

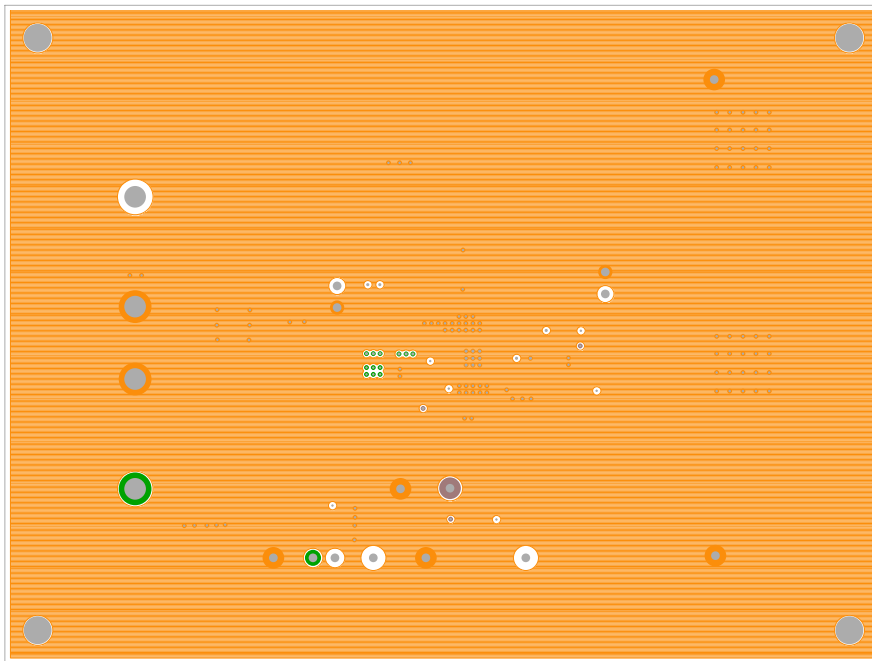

Figure 7. Second Layer

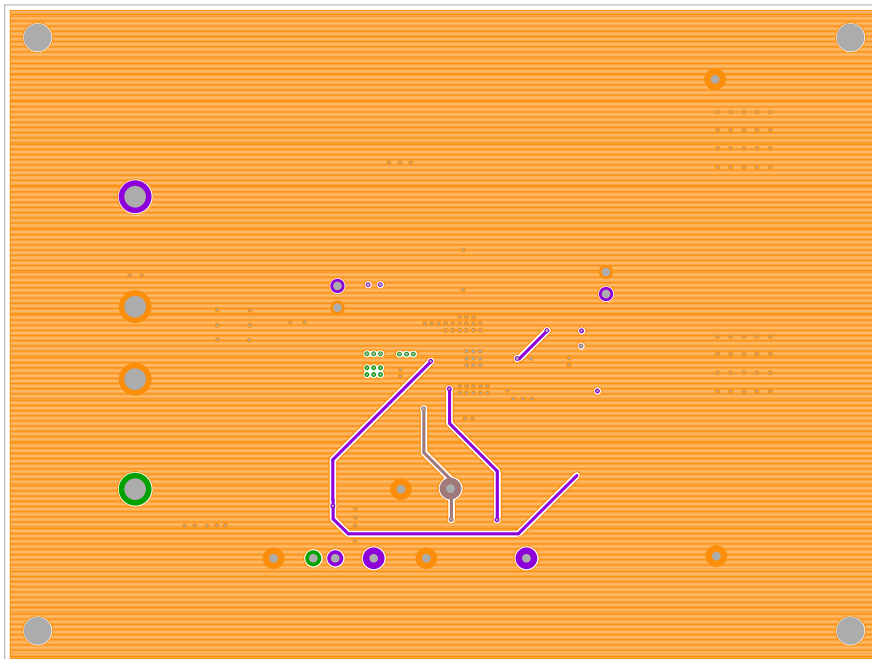

Figure 8. Third Layer

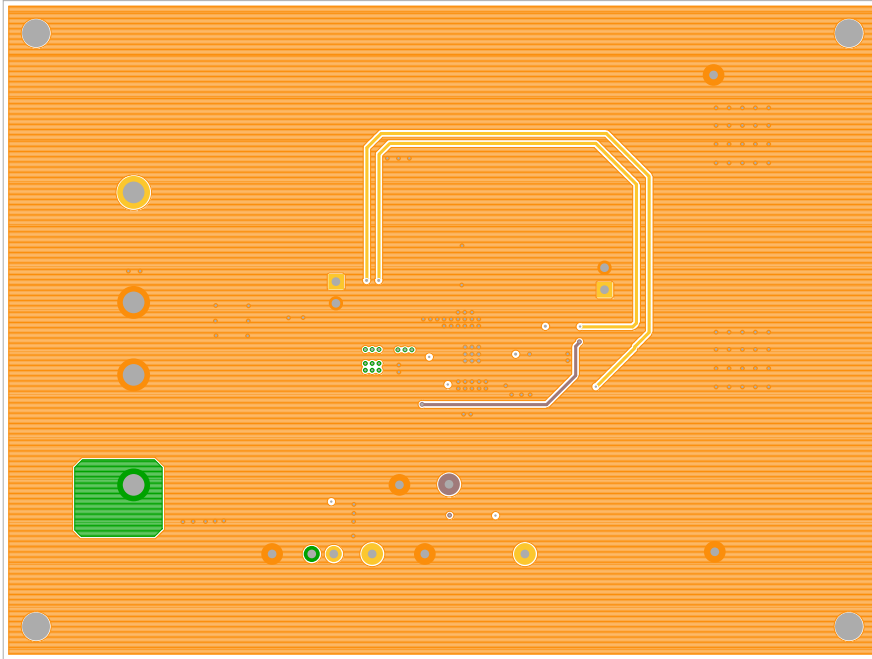

Figure 9. Bottom Layer

3. Typical Performance Graphs

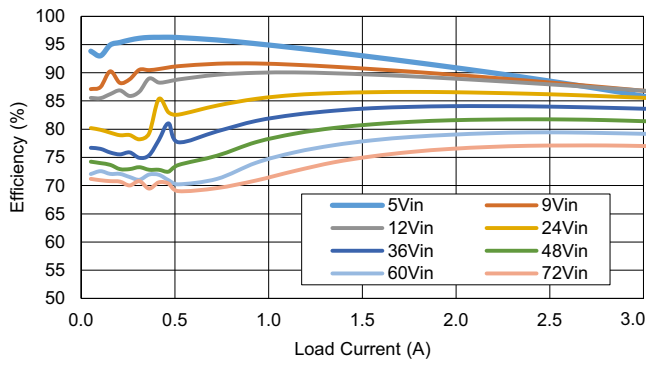

Figure 10. Efficiency vs Load

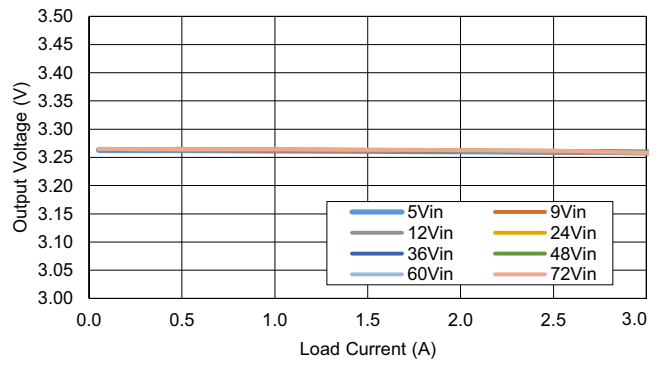

Figure 11. Load Regulation

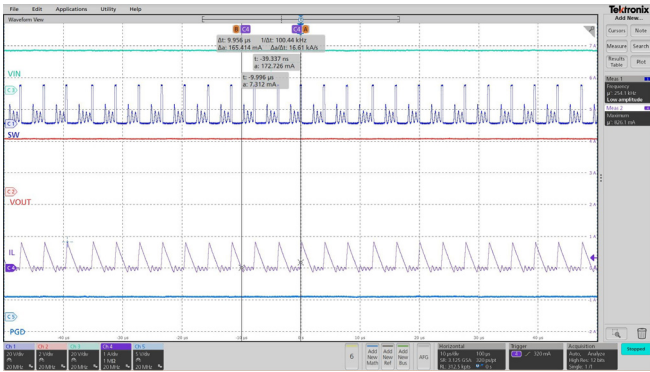

Figure 12. Steady State at 0.2A Load

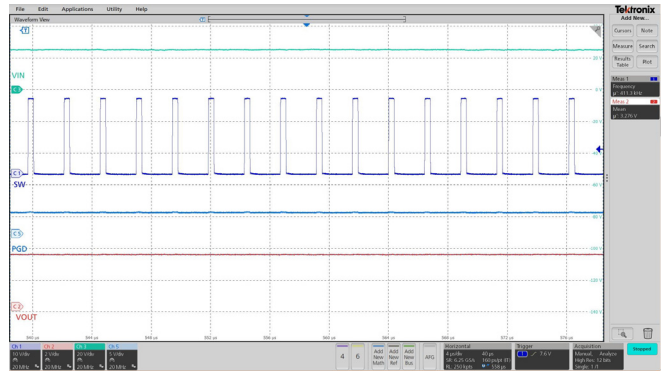

Figure 13. Steady State at 2A Load

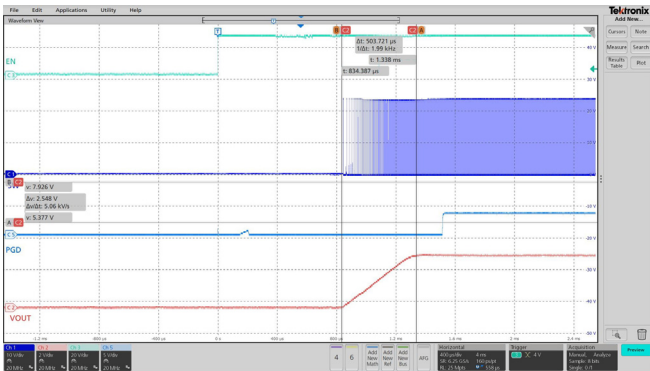

Figure 14. Startup by EN at 1A Load

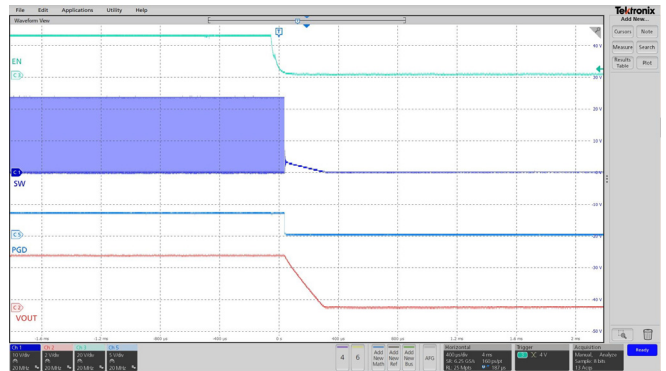

Figure 15. Shutdown by EN at 1A Load

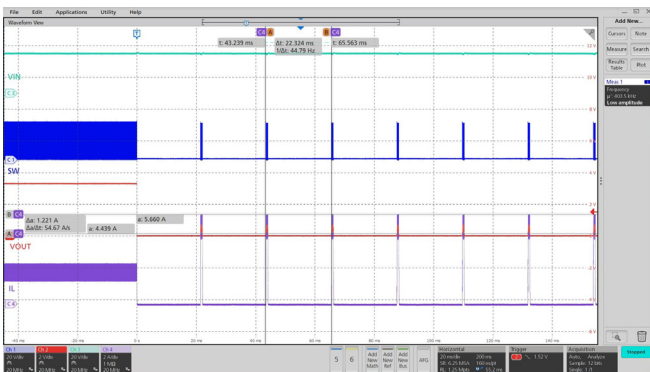

Figure 16. Overcurrent Protection

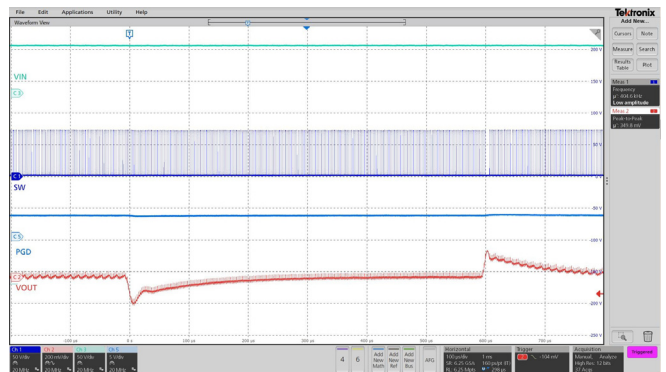

Figure 17. Load Transient 1A to 3A to 1A

4. Ordering Information

Part Number	Description
RTKA211835DE0010BU	RAA211835 (HTSSOP version) evaluation board

5. Revision History

Revision	Date	Description
1.00	Nov 4, 2022	Initial release

IMPORTANT NOTICE AND DISCLAIMER

RENESAS ELECTRONICS CORPORATION AND ITS SUBSIDIARIES (“RENESAS”) PROVIDES TECHNICAL SPECIFICATIONS AND RELIABILITY DATA (INCLUDING DATASHEETS), DESIGN RESOURCES (INCLUDING REFERENCE DESIGNS), APPLICATION OR OTHER DESIGN ADVICE, WEB TOOLS, SAFETY INFORMATION, AND OTHER RESOURCES “AS IS” AND WITH ALL FAULTS, AND DISCLAIMS ALL WARRANTIES, EXPRESS OR IMPLIED, INCLUDING, WITHOUT LIMITATION, ANY IMPLIED WARRANTIES OF MERCHANTABILITY, FITNESS FOR A PARTICULAR PURPOSE, OR NON-INFRINGEMENT OF THIRD PARTY INTELLECTUAL PROPERTY RIGHTS.

These resources are intended for developers skilled in the art designing with Renesas products. You are solely responsible for (1) selecting the appropriate products for your application, (2) designing, validating, and testing your application, and (3) ensuring your application meets applicable standards, and any other safety, security, or other requirements. These resources are subject to change without notice. Renesas grants you permission to use these resources only for development of an application that uses Renesas products. Other reproduction or use of these resources is strictly prohibited. No license is granted to any other Renesas intellectual property or to any third party intellectual property. Renesas disclaims responsibility for, and you will fully indemnify Renesas and its representatives against, any claims, damages, costs, losses, or liabilities arising out of your use of these resources. Renesas' products are provided only subject to Renesas' Terms and Conditions of Sale or other applicable terms agreed to in writing. No use of any Renesas resources expands or otherwise alters any applicable warranties or warranty disclaimers for these products.

(Rev.1.0 Mar 2020)

Corporate Headquarters

TOYOSU FORESIA, 3-2-24 Toyosu,
Koto-ku, Tokyo 135-0061, Japan
www.renesas.com

Contact Information

For further information on a product, technology, the most up-to-date version of a document, or your nearest sales office, please visit:
www.renesas.com/contact/

Trademarks

Renesas and the Renesas logo are trademarks of Renesas Electronics Corporation. All trademarks and registered trademarks are the property of their respective owners.