

RTKA223182DR0000BU

Dual Output 11W 3-phase Input Flyback Demonstration Board using RAA223182

The dual output 11W universal input Flyback demonstration board, RTKA223182DR0000BU, featured RAA223182 1000V regulator demonstrates a low-cost, high-performance isolated AC/DC solution from a universal 3-phase input of 121V_{AC} to 500V_{AC}, to 12.5V and 5V outputs for smart Meter applications.

The RTKA223182DR0000BU has proprietary cost-saving features, such as the short-time heavy load operation, which eliminates the need for transformer over-design for the short-time heavy load in communication. The board operates in DCM with constant frequency at 50kHz in normal operation, complimented with valley switching, reducing switching losses and EMI noises. The board has built-in protections against input brownout, V_{CC} UV, V_{CC} OV, V_{IN} UV, V_{IN} OV, overload, output short-circuit, primary winding short, and over-temperature. The board is pre-compliant with EN55022/CISPR 22 Class B conducted EMI limits and has the 4kV surge capability by IEC61000-4-5 standard.

Features

- Short-time heavy load support
- Low BOM cost design
- EMI compliance for EN55022/CISPR22
- Surge test compliance to IEC61000-4-5 up to 4kV

Specifications

This board is optimized for the following operating conditions:

- Input voltage: 121V_{AC} ~ 500V_{AC} (phase to phase)
- Operating temperature: -40C~105C
- Output: 12.5V/800mA; 5V/200mA
- Output power: 11W
- Max short-time load support (80ms, set by the OVL pin cap): 21W
- Efficiency: >75% at 100% load; >70% at 50% load
- Load regulation: 12.5V: <3.1%; 5V: <9.3%, 10% to 100% load
- Board dimension: 105mm×58mm.

Contents

1. Functional Description	3
1.1 Recommended Equipment	3
1.2 Setup and Configuration	3
2. Board Design	4
2.1 Photo	4
2.2 Schematic Diagram	5
2.3 Layout Guidelines	6
2.4 Board Layout	6
2.5 Bill of Materials	7
2.6 Transformer Specifications	9
3. Typical Performance Graphs	10
3.1 Short-Time Heavy Load	11
3.2 EMI Performance	12
4. Ordering Information	12
5. Revision History	12

1. Functional Description

The RTKA223182DR0000BU consists of a 3-phase input stage^[1], the power stage^[2], and the control circuit surrounding the RAA223182 Flyback controller.

The input stage ensures the power supply meets the requirement set by the UL safety, IEC surge immunity, and IEC-conducted EMI standards. The power converter is fed with a rectified voltage buffered by C9 and C19. The voltage regulation of two outputs is implemented by a secondary side TL431 circuit and an optocoupler, U2, with weighted feedback through R3, R1, and R5. In this design, the 12.5V has dominant feedback (~85% weight), and 5V has lighter feedback (~15% weight). R12 sets the switching frequency at 50kHz. R13 sets the maximum power for the chosen transformer. C10 sets the maximum allowed time for a transient overload.

1.1 Recommended Equipment

- Three-phase AC Power supply capable of generating line voltage from 121V_{AC} to 500V_{AC} at 60Hz/50Hz, with at least 100mA output current capability.
- A load resistor box with an adjustable value of 15.6Ω and up or an electronics load that can emulate a resistor load or current load up to 800mA for 12.5V output. A load resistor box with an adjustable value of 25Ω and up or an electronics load that can emulate a resistor load or current load up to 200mA for 5V output.
- Multimeters to measure the output voltage and current
- Power meter to measure the AC input power

1.2 Setup and Configuration

1. Program the AC power supply with a voltage between 121V_{AC} to 500V_{AC} at the corresponding frequency of 60Hz or 50Hz.
2. While the AC power supply is off, connect the output cables of the AC power supply to the Va, Vb, Vc, and VN terminals of the RTKA223182DR0000BU. An optional power meter can be added between the AC power supply output and the input of the board.
3. Connect the corresponding load to the output terminal 13VOUT and GND and 5VOUT and GND, respectively.
4. Connect a voltage meter to VOUT and GND and connect a current meter between the board outputs and the load.
5. Turn on the AC power supply..

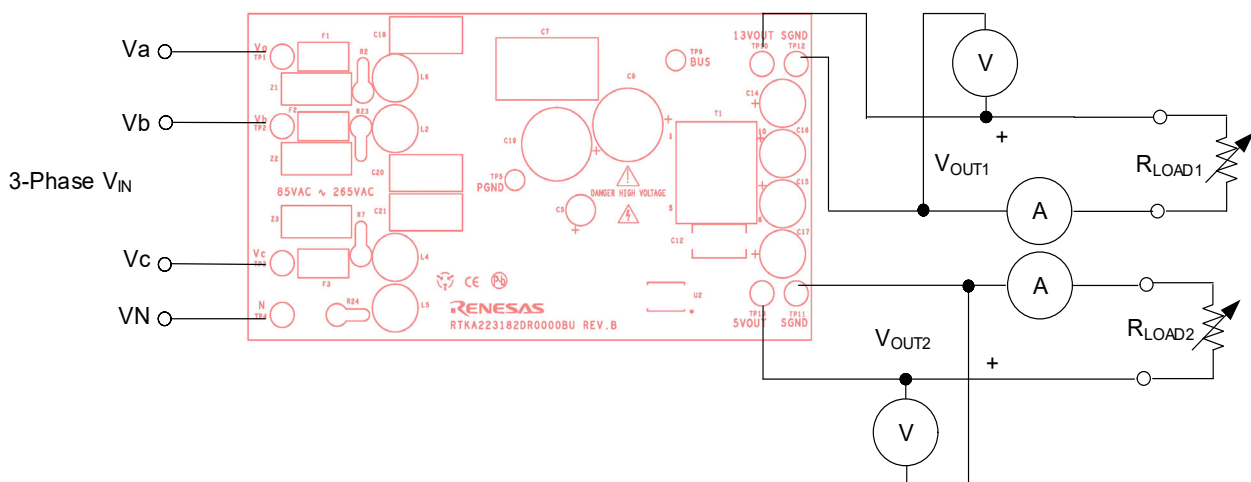

Figure 1. RTKA223182DR0000BU Connection Diagram

1. F1, F2, F3, Z1, Z2, Z3, R2, R7, R23, R24, L2, L4, L5, L6, D2, D4, C18, C20, C21, C7, and optional L1
2. C9, C19, T1, D8, C14, C16, D9, C15 and C17

2. Board Design

2.1 Photo

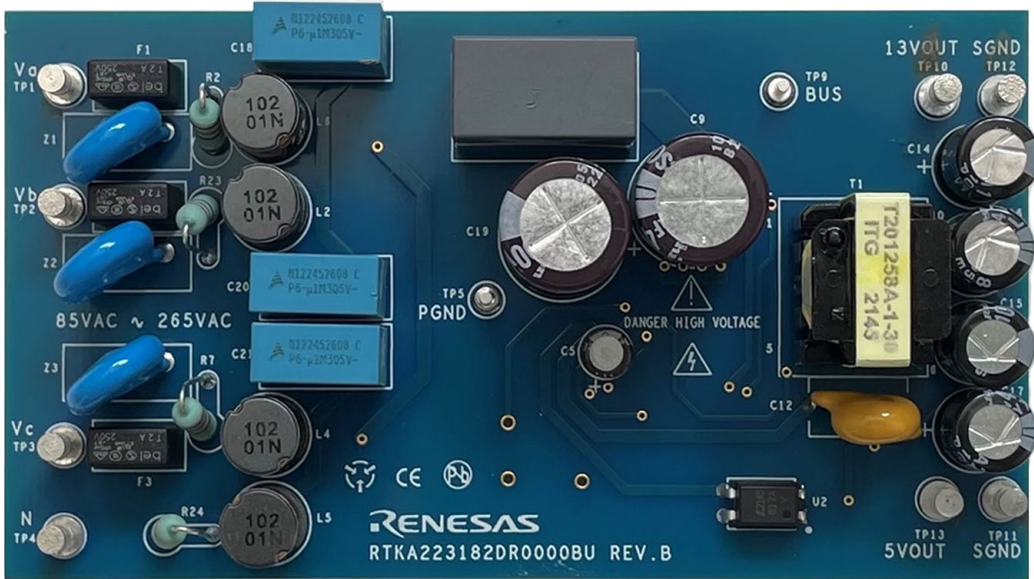

Figure 2. RTKA223182DR0000BU Evaluation Board (Top)

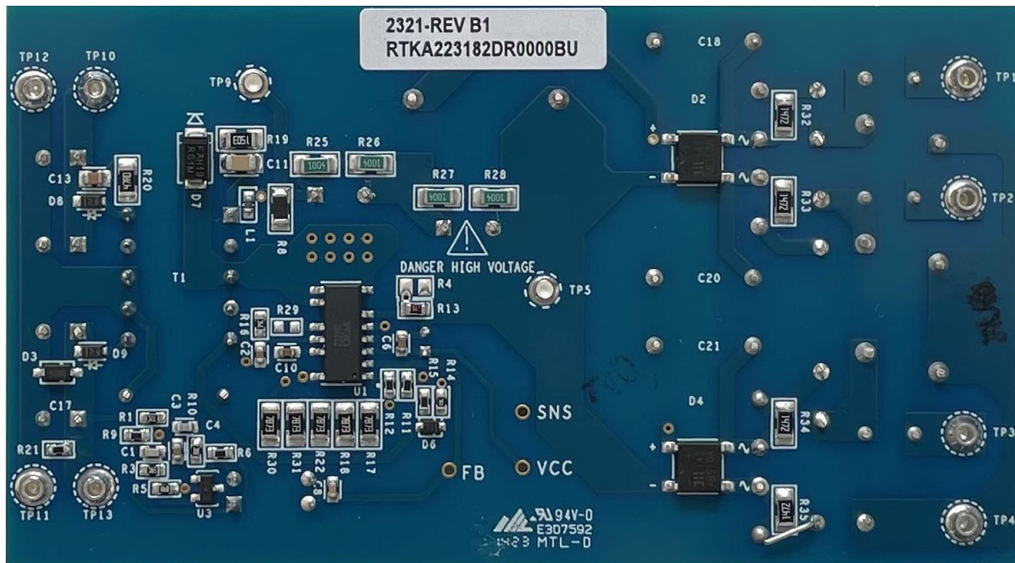

Figure 3. RTKA223182DR0000BU Evaluation Board (Bottom)

2.2 Schematic Diagram

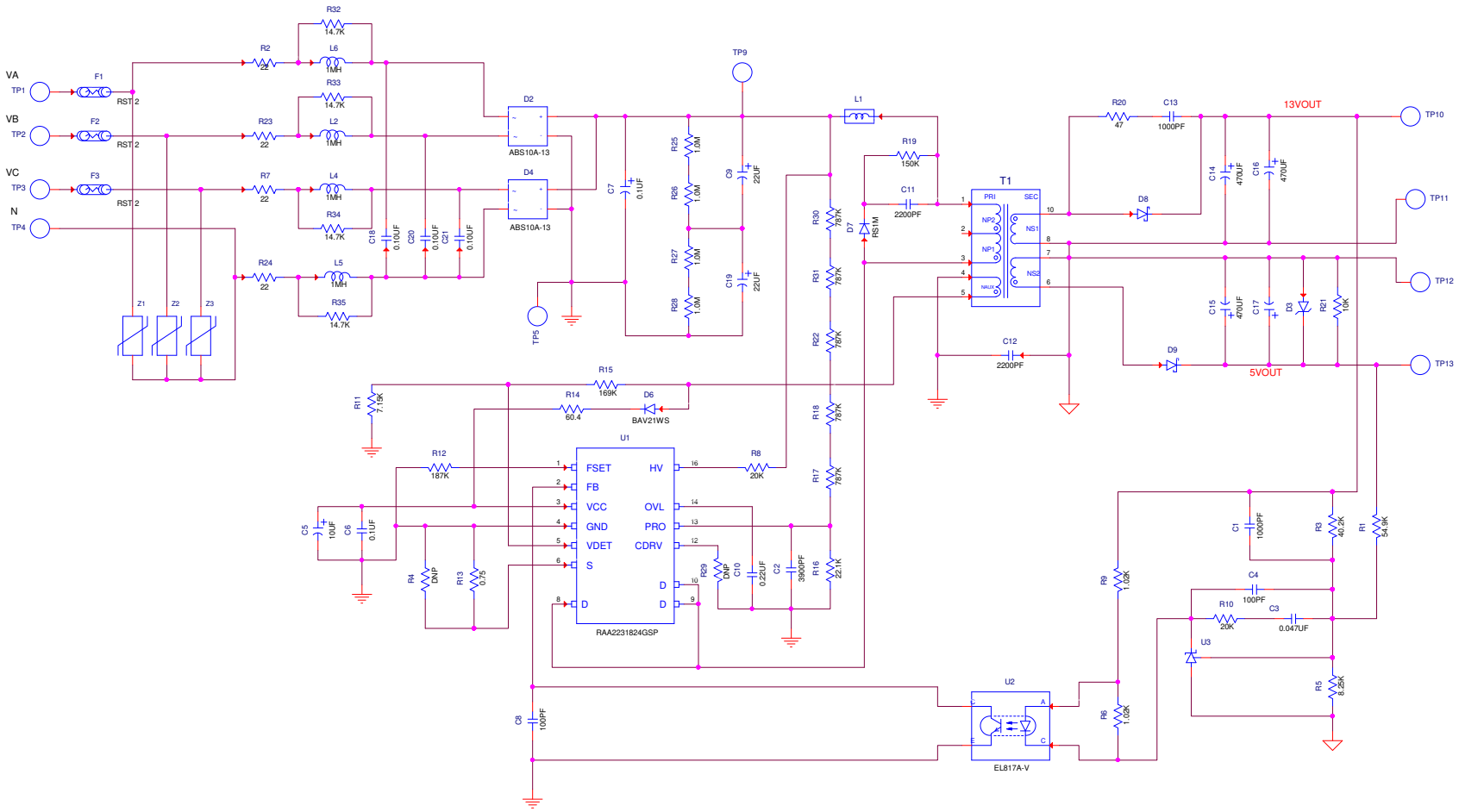

Figure 4. RTKA223182DR0000BU Schematic

2.3 Layout Guidelines

Proper layout is important to ensure a stable operation, good thermal behavior, EMI performance, and reliable operation for various operating environments. Pay attention to the following layout recommendations:

- Leave proper spacing. Recommend a minimum of 1.5mm between traces with voltage differences up to 400V and 2mm between traces with voltage differences up to 780V.
- Keep a small loop from the input bulk capacitor, transformer primary winding, D pin, S pin to the input bulk capacitor ground pin. Also keep a small loop consisting of the secondary winding, rectifier diode, and output capacitor.
- Use the star connection of ground traces as shown in the top layout picture (Figure 5). The connection point needs to be close to the IC ground pin.
- Place the VCC decoupling capacitor close to the VCC pin.
- Keep sufficient copper area on the IC drain pin (around 165mm² for single-phase 6W output or 3-phase 11W output) for better thermal performance.
- Make the traces connected to secondary rectifier diodes thick enough so they provide enough heat dissipation.

2.4 Board Layout

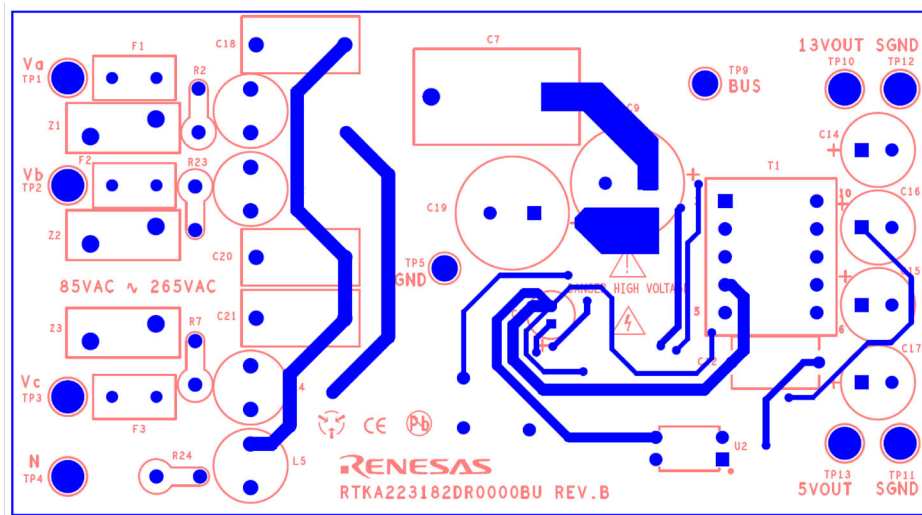

Figure 5. Top Layer

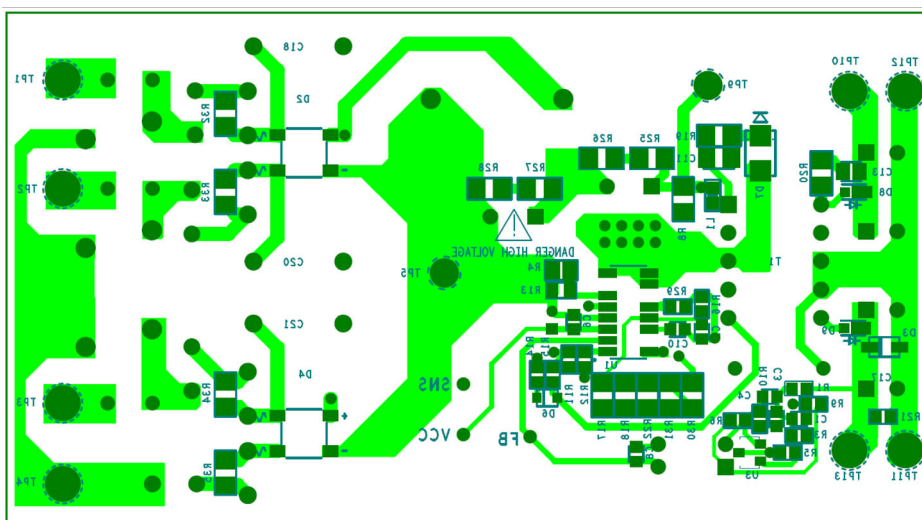

Figure 6. Bottom Layer

2.5 Bill of Materials

Qty	Reference Designator	Description	Value	Manufacturer	Manufacturer Part Number
3	F1, F2, F3	Fuse	2A, 250V _{AC} , Radial	Bel Fuse	RST 2
2	D2, D4	1A 1000V Bridge Rectifier	1A, 1000V, ABS	Diodes Inc	ABS10A-13
1	D3	Zener Diode	5.6V, 500mW, SOD-123	Micro commercial	BZT52C5V6-TP
1	D6	General Purpose Diode	0.2A, 200V, SOD-323	Micro commercial	BAV21WS-TP
1	D7	Fast Recovery Diode	1A, 1kV, SMA	On-semi	RS1M
2	D8, D9	Schottky Rectifier	2A, 120V, DO-219AD	Vishay	V2PM12
1	L1	Ferrite Bead, SMD	60Ω at 100MHz, 0603	Murata	BLM18PG600SN1D
4	L2, L4, L5, L6	Fixed Inductor	1mH, 5%, 0.1A, Axial	TDK	RCH8011NP-102L
1	C1	Multilayer Ceramic Cap	1000pF, 10%, 50V, 0603	Generic	Various
1	C2	Multilayer Ceramic Cap	3900pF, 10%, 50V, 0603	Generic	Various
1	C3	Multilayer Ceramic Cap	47nF, 10%, 50V, 0603	Generic	Various
1	C4	Multilayer Ceramic Cap	100pF, 10%, 50V, 0603	Generic	Various
1	C6	Multilayer Ceramic Cap, X7R	0.1μF, 10%, 50V, 0603	Generic	Various
1	C5	Aluminum Cap, radial	10μF, 20%, 25V, 0603	Nichicon	UMV1E100MFD1TP
1	C8	Multilayer Ceramic Cap	100pF, 10%, 50V, 0603	Generic	Various
1	C9, C19	Aluminum Electrolytic 105C rated >5khrs	22μF, 20%, 400V, Radial	Nichicon	UCS2G220MHD
1	C10	Multilayer Ceramic Cap	0.22μF, 10%, 25V, 0603	Generic	Various
1	C11	Multilayer Ceramic Cap	2.2nF, 10%, 630V, 1206	Murata	GRM31BR72J222KW01L
1	C12	AC Rated Class Y1 Ceramic Disk Capacitor	2200pF, 20%, 500V _{AC}	Vishay	VY1222M37Y5VQ63V0
1	C13	Multilayer Ceramic Cap	1nF, 10%, 200V, 0805	Generic	Various
2	C7	Film Cap, Radial	0.1μF, 10%, 1kV, Radial	Kemet	R75QI31005030J
2	C14, C16	Aluminum Electrolytic 105C rated 8khrs	470μF, 20%, 16V, RADIAL	Rubycon	16ZLH470MEFCT78X11.5
2	C15, C17	Aluminum Electrolytic 105C rated 6khrs	470μF, 20%, 10V, RADIAL	Rubycon	10YXF470MEFCT78X11.5
3	C18, C20, C21	Film Cap, X2 type	0.1μF, RADIAL, 20%, 305V	TDK	B32921C3104M189
1	R1	Thick Film Chip Resistor	54.9k, 1%, 1/16W, 0603	Generic	Various

Qty	Reference Designator	Description	Value	Manufacturer	Manufacturer Part Number
1	R2, R7, R23, R24	Wire-wound Resistors	22, 5%, 1W, axial	Yageo	KNP100JR-73-22R
1	R3	Thick Film Chip Resistor	40.2k, 1%, 1/16W, 0603	Generic	Various
0	R4	Thick Film Chip Resistor	DNP	Generic	Various
1	R5	Thick Film Chip Resistor	8.25k, 1%, 1/16W, 0603	Generic	Various
2	R6, R9	Thick Film Chip Resistor	1.02k, 1%, 1/16W, 0603	Generic	Various
1	R8	Thick Film Chip Resistor	10k, 1%, 1/4W, 1206	Generic	Various
1	R10	Thick Film Chip Resistor	20k, 1%, 1/16W, 0603	Generic	Various
1	R11	Thick Film Chip Resistor	7.15k, 1%, 1/16W, 0603	Generic	Various
1	R12	Thick Film Chip Resistor	187k, 1%, 1/16W, 0603	Generic	Various
1	R13	Thick Film Chip Resistor	0.75, 1%, 1/8W, 0805	Generic	Various
1	R14	Thick Film Chip Resistor	60.4, 1%, 1/16W, 0603	Generic	Various
1	R15	Thick Film Chip Resistor	169k, 1%, 1/16W, 0603	Generic	Various
1	R16	Thick Film Chip Resistor	22.1k, 1%, 1/16W, 0603	Generic	Various
5	R17, R18, R22, R30, R31	Thick Film Chip Resistor	787k, 1%, 1/4W, 1206	Generic	Various
1	R19	Thick Film Chip Resistor	150k, 1%, 1/8W, 1206	Generic	Various
1	R20	Thick Film Chip Resistor	47, 5%, 1/8W, 1206	Generic	Various
4	R25~R28	Thick Film Chip Resistor	1M, 1%, 1/4W, 1206	Generic	Various
4	R32~R35	Thick Film Chip Resistor	14.7k, 1%, 1/4W, 1206	Generic	Various
1	T1	Transformer	1.3mH, 10%, EE16, PTH	ITG	T201258A-1-30
1	U1	1000V, Off-line Flyback Regulator	RAA223182, SO13	Renesas	RAA223182
1	U2	Optocoupler	CTR: 80-160, PTH	Lite-On	LTV-817-A
1	U3	Shunt Regulator	TL431, SOT23	Nexperia	TL431AQDBZR,215
3	Z1, Z2, Z3	Varistor	430V 2.5KA PTH	Bourns	MOV-10D431KTR

2.6 Transformer Specifications

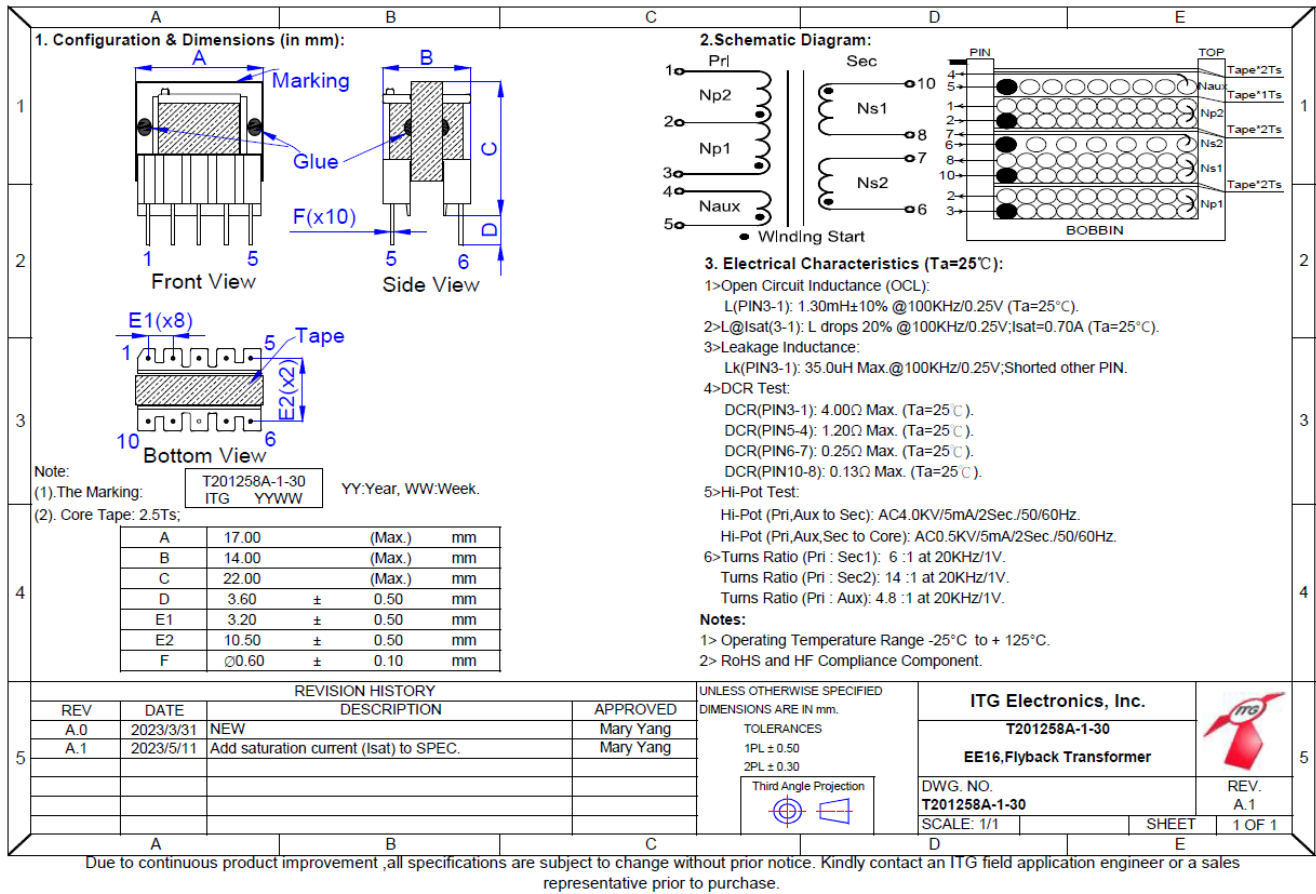

Figure 7. Transformer Specifications and Construction

The transformer for the demonstration board is a customized part by ITG, and has the following key characteristics:

- Low cost E16 core
- Meet 7.0mm clearance and creepage distance
- Reinforced insulation with triple insulated wires
- Isolation voltage: 4kV AC (4kV AC at 2 sec)
- Dual output
- Operating temperature: -25C~+125C
- RoHS and Halogen Free compliance

3. Typical Performance Graphs

$V_{IN} = 121V_{AC} \sim 500V_{AC}$, $V_{OUT1} = 12.5V$, $I_{OUT1} = 800mA$ (max), $V_{OUT2} = 5V$, $I_{OUT2} = 200mA$ (max), $T_A = +25^{\circ}C$

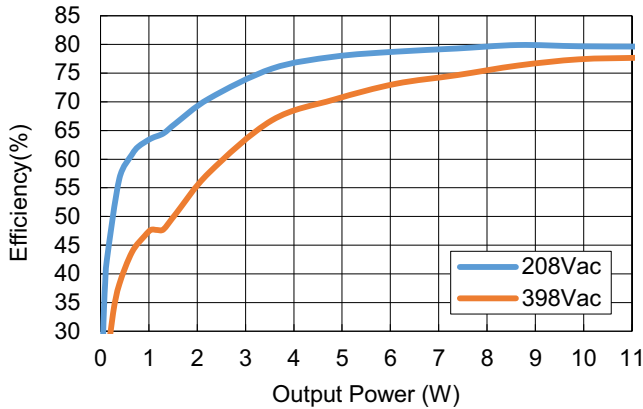

Figure 8. Efficiency Overload Range

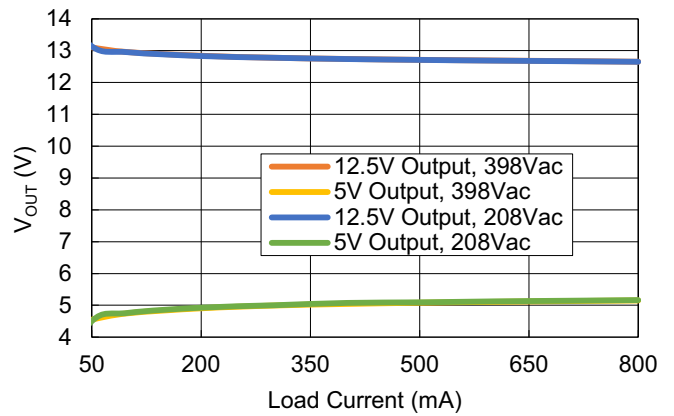

Figure 9. Load Regulation with 13V Load Sweep

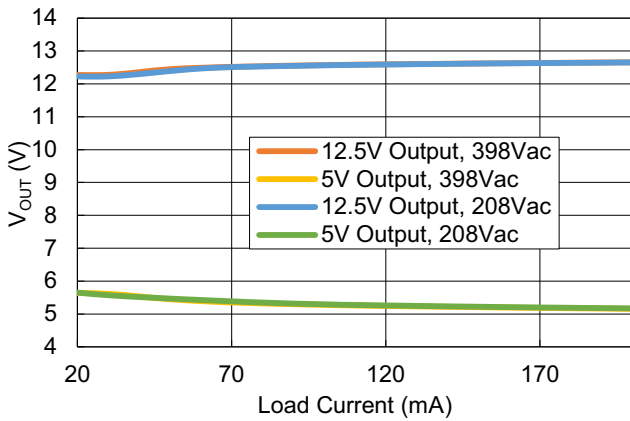

Figure 10. Load Regulation with 5V Load Sweep

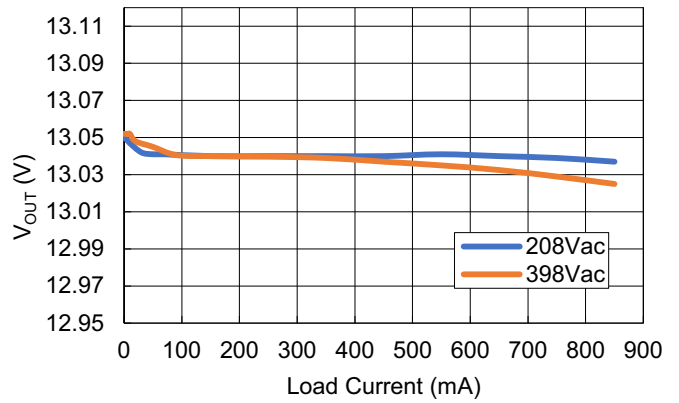

Figure 11. Load Regulation with Single Output
(R5 = 9.31k, R1: Not Install)

Table 1. Typical Light-Load and No-Load Power Consumption (25C Ambient)

Input Voltage (Phase to Phase)	Input Power with 340mW Load (Per Phase)	No-Load Power (Per Phase)
208V _{AC} /60Hz	189mW	41.7mW
398V _{AC} /50Hz	288mW	89.7mW

3.1 Short-Time Heavy Load

The RTKA223182DR0000BU can support the short-time heavy load, as Figure 12 shows. The allowed operation time is limited by the capacitor on the OVL pin, as calculated by Equation 13 in the datasheet. A bigger OVL capacitor allows longer heavy-load operation. If the heavy load is removed before the programmed time, the IC switches at 2x frequency until the time length is reached, as Figure 14 shows. When the OVL pin is grounded, the IC operates at 2x frequency indefinitely. How long the IC can operate in this mode depends on the thermal capability of the board design with the given IC thermal resistance. When the pin is floated, the 2x frequency operation is disabled.

Figure 15 shows the drain voltage waveform when AC input voltage reaches up to 500V_{AC} in a heavy load (21W) operation. It can be seen that the peak of drain voltage is about 870V, which still has 130V margin to the maximum voltage rating of the internal FET. This makes RAA223182 a right candidate for 3-phase applications.

$$V_{IN} = 230V_{AC}, V_{OUT1} = 13V, V_{OUT2} = 5V, I_{OUT2} = 200mA, T_A = +25^{\circ}C$$

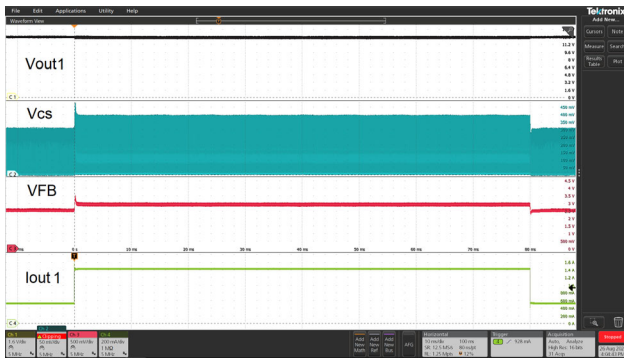

Figure 12. Short-Time Heavy Load Operation

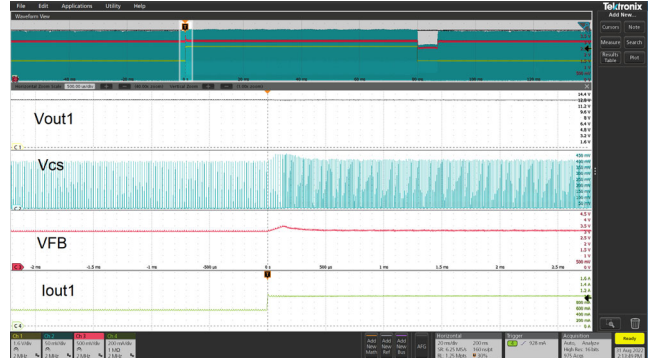

Figure 13. Zoomed View of Short-Time Heavy Load Operation

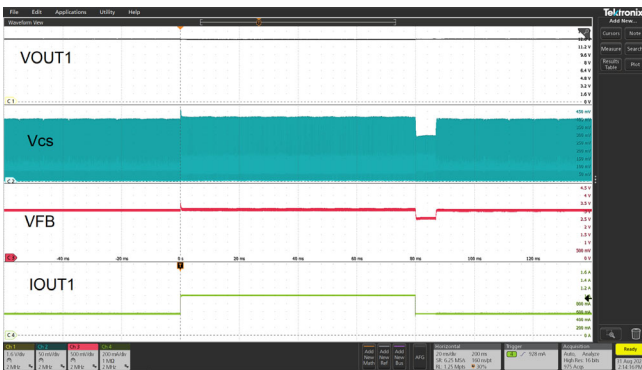

Figure 14. Heavy Load Lasts Shorter than the Programmed Time Length

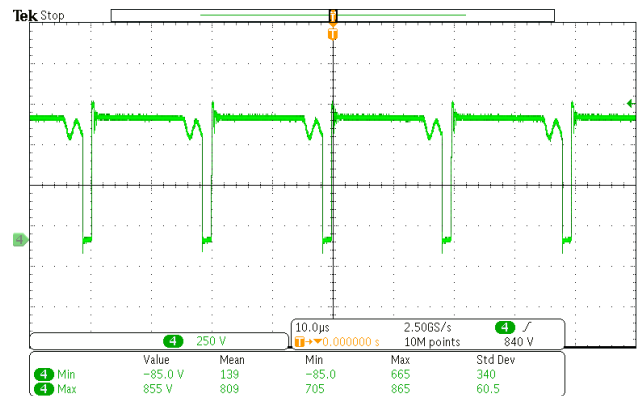

Figure 15. Drain Voltage with 500V_{AC} Input and 21W Short-Time Heavy Load

3.2 EMI Performance

RTKA223182DR000BU is compliant to the conducted EMI requirements of FCC Part 15 and CISPR22 Class B.

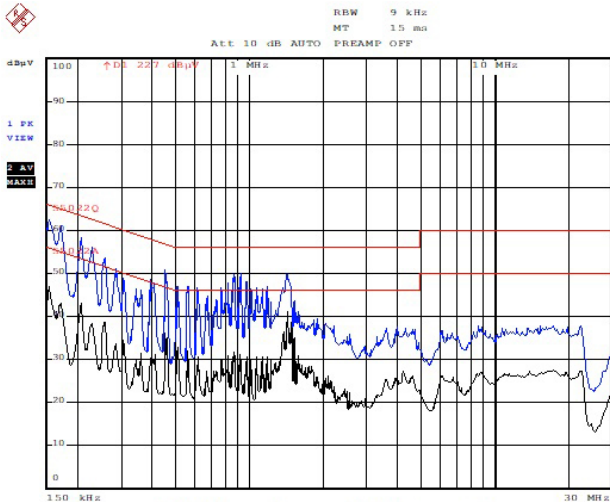

Figure 16. 207V_{AC} Phase-to-Phase, Line

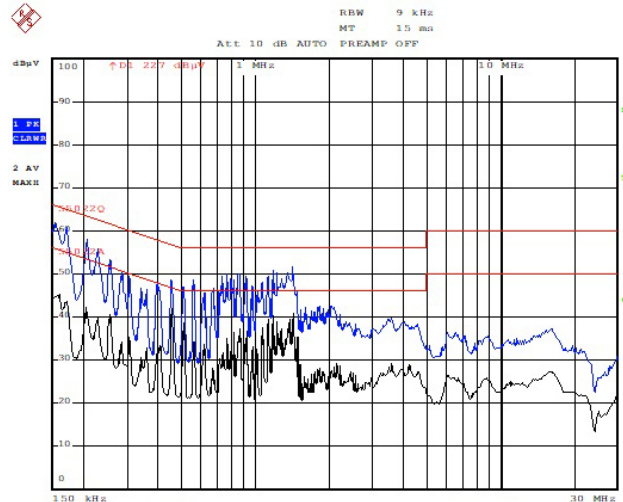

Figure 17. 207V_{AC} Phase-to-Phase, Neutral

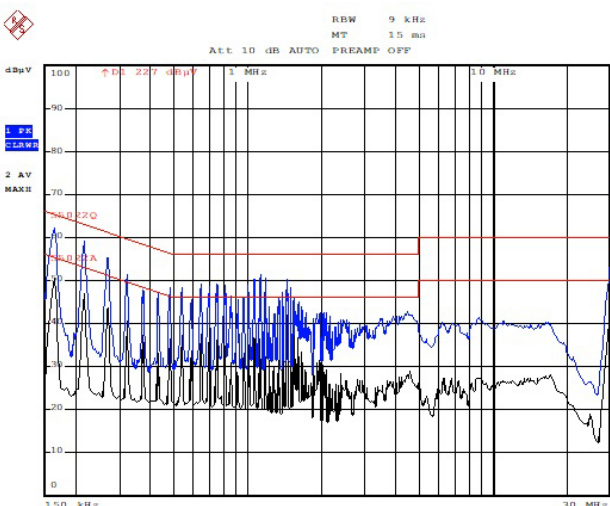

Figure 18. 276V_{AC} Phase-to-Phase, Line

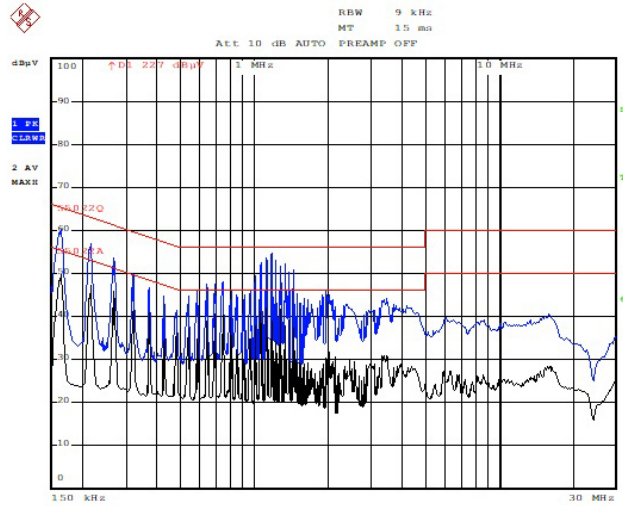

Figure 19. 276V_{AC} Phase-to-Phase, Neutral

4. Ordering Information

Part Number	Description
RTKA223182DR000BU	RAA223182 Demo Board

5. Revision History

Revision	Date	Description
1.01	Mar 8, 2024	Updated BOM
1.00	Sep 8, 2023	Initial release

IMPORTANT NOTICE AND DISCLAIMER

RENESAS ELECTRONICS CORPORATION AND ITS SUBSIDIARIES (“RENESAS”) PROVIDES TECHNICAL SPECIFICATIONS AND RELIABILITY DATA (INCLUDING DATASHEETS), DESIGN RESOURCES (INCLUDING REFERENCE DESIGNS), APPLICATION OR OTHER DESIGN ADVICE, WEB TOOLS, SAFETY INFORMATION, AND OTHER RESOURCES “AS IS” AND WITH ALL FAULTS, AND DISCLAIMS ALL WARRANTIES, EXPRESS OR IMPLIED, INCLUDING, WITHOUT LIMITATION, ANY IMPLIED WARRANTIES OF MERCHANTABILITY, FITNESS FOR A PARTICULAR PURPOSE, OR NON-INFRINGEMENT OF THIRD-PARTY INTELLECTUAL PROPERTY RIGHTS.

These resources are intended for developers who are designing with Renesas products. You are solely responsible for (1) selecting the appropriate products for your application, (2) designing, validating, and testing your application, and (3) ensuring your application meets applicable standards, and any other safety, security, or other requirements. These resources are subject to change without notice. Renesas grants you permission to use these resources only to develop an application that uses Renesas products. Other reproduction or use of these resources is strictly prohibited. No license is granted to any other Renesas intellectual property or to any third-party intellectual property. Renesas disclaims responsibility for, and you will fully indemnify Renesas and its representatives against, any claims, damages, costs, losses, or liabilities arising from your use of these resources. Renesas' products are provided only subject to Renesas' Terms and Conditions of Sale or other applicable terms agreed to in writing. No use of any Renesas resources expands or otherwise alters any applicable warranties or warranty disclaimers for these products.

(Disclaimer Rev.1.01 Jan 2024)

Corporate Headquarters

TOYOSU FORESIA, 3-2-24 Toyosu,
Koto-ku, Tokyo 135-0061, Japan
www.renesas.com

Trademarks

Renesas and the Renesas logo are trademarks of Renesas Electronics Corporation. All trademarks and registered trademarks are the property of their respective owners.

Contact Information

For further information on a product, technology, the most up-to-date version of a document, or your nearest sales office, please visit www.renesas.com/contact-us/.