

RTKA223882DE0000BU

Dual Output 25W Universal Input Flyback Evaluation Board

The dual output 25W universal input Flyback evaluation board, RTKA223882DE0000BU, features the RAA223882 700V regulator and demonstrates a low-cost high performance isolated AC/DC solution from a universal input of 85V<sub>AC</sub> to 265V<sub>AC</sub>, to 12V and 5.9V outputs.

The RTKA223882DE0000BU is a low-cost input EMI filter, pre-compliant with EN55022/CISPR 22 Class B conducted EMI limits. It also passes the 4kV surge capability by IEC61000-4-5 standard.

Features

- Universal input from 85Vac to 265Vac
- Low BOM cost design
- EMI compliance for EN55022/CISPR22
- Surge test compliance to IEC61000-4-5 up to 4kV

Specifications

This board is optimized for the following operating conditions:

- Input voltage: 85V<sub>AC</sub> ~ 265V<sub>AC</sub>
- Operating temperature: -10°C~50°C
- Output (max): 12V/2A; 5.9V/1A
- Output power (max):
  - 25W<sup>[1]</sup> - 85V<sub>AC</sub>~265V<sub>AC</sub> input
  - 30W<sup>[1]</sup> - 120V<sub>AC</sub>~230V<sub>AC</sub> input
- Efficiency: >80% at 10%~100% load; 70% at 300mW load
- Board dimension: 82mm×48mm

1. Defined by IC temperature rise ≤40°C in open frame no fan condition.

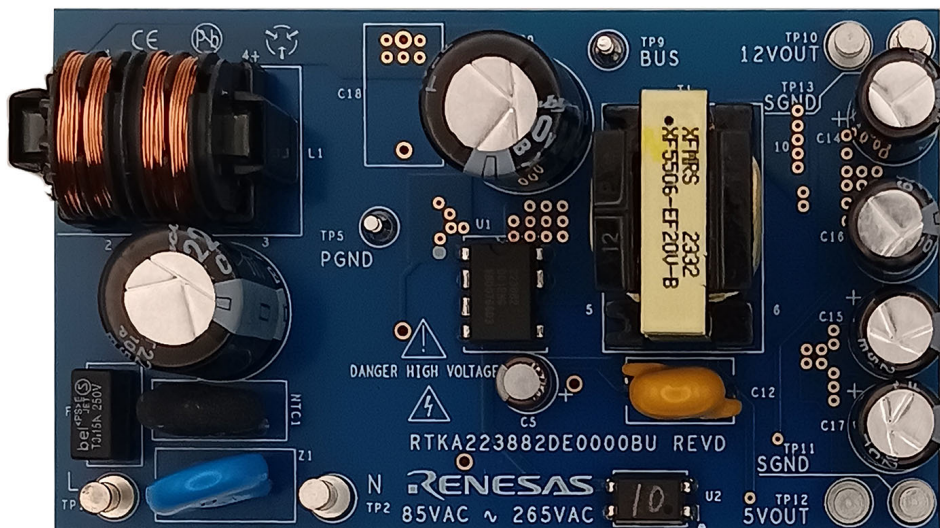

Figure 1. RTKA223882DE0000BU Evaluation Board

## Contents

<b>1. Functional Description</b>	<b>3</b>
1.1 Recommended Equipment	3
1.2 Setup and Configuration	3
<b>2. Board Design</b>	<b>4</b>
2.1 Schematic Diagrams	5
2.2 Bill of Materials	5
2.3 Transformer Specifications	6
2.4 Board Layout	8
2.5 Layout Guidelines	8
<b>3. Typical Performance</b>	<b>9</b>
3.1 EMI Test Results	10
<b>4. Ordering Information</b>	<b>11</b>
<b>5. Revision History</b>	<b>11</b>

# 1. Functional Description

The RTKA223882DE0000BU consisted of a low-cost input stage (F1, Z1, NTC1, D2, C2, L1), the power stage (C9, T1, D1, D8, C14, C16, D4, D9, C15, and C17), and the control circuit surrounding the RAA223882 Flyback controller.

The input stage ensures that the power supply meets the UL safety requirement, IEC surge immunity, and IEC conducted, and radiated EMI standards. The power converter is fed with a rectified voltage buffered by C9. The voltage regulation of two outputs is implemented by a secondary side TL431 circuit and an opto-coupler, U2, with weighted feedback through R3, R1, and R5. In this design, 12V has dominant feedback (~85% weight) and 5.9V has lighter feedback (~15% weight). R4 and R13 set the maximum power for the chosen transformer.

## 1.1 Recommended Equipment

- AC Power supply capable of generating AC voltage from 85V<sub>AC</sub> to 265V<sub>AC</sub> at 60Hz/50Hz with at least 400mA output current capability.
- A load resistor box with adjustable value of 6Ω and up, or an electronics load that can emulate a resistor load or current load up to 2A for 12V output. A load resistor box with adjustable value of 5.9Ω and up, or an electronics load that can emulate a resistor load or current load up to 1A for 5.9V output.
- Multi-meters to measure the output voltage and current.
- Power meter to measure the AC input power.

## 1.2 Setup and Configuration

1. Program the AC power supply with a voltage between 85V<sub>AC</sub> and 265V<sub>AC</sub> at the corresponding frequency of 60Hz or 50Hz.
2. While the AC power supply is off, connect the output cables of the AC power supply to the L and N terminal of the RTKA223882DE0000BU. An optional power meter can be added between the AC power supply output and the input of the board.
3. Connect the corresponding load to the output terminal 12VOUT to GND, and 5.9VOUT to GND, respectively.
4. Connect a voltage meter to VOUT and GND, and connect a current meter between board outputs and the load.
5. Turn on the AC power supply.

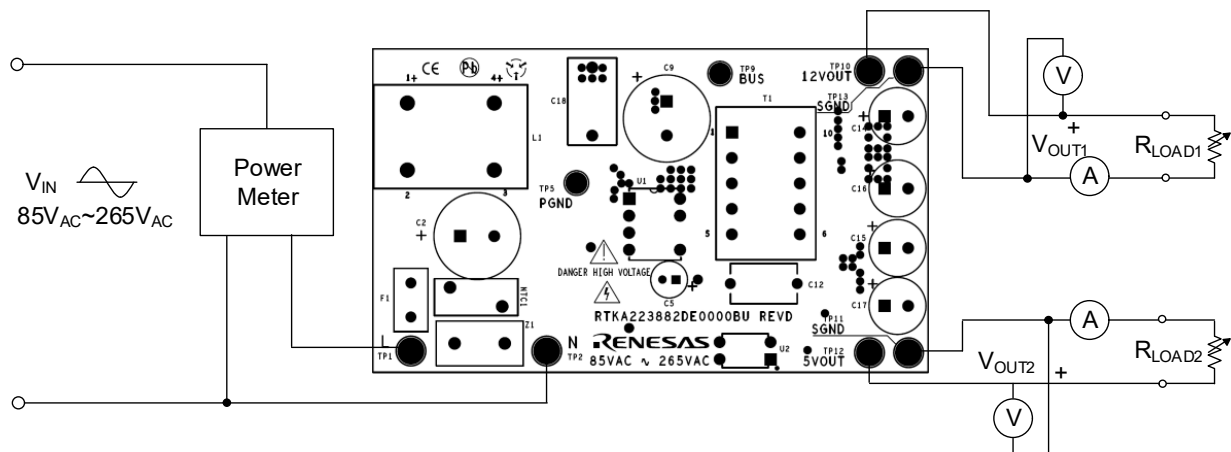

Figure 2. RTKA223882DE0000BU Connection Diagram

## 2. Board Design

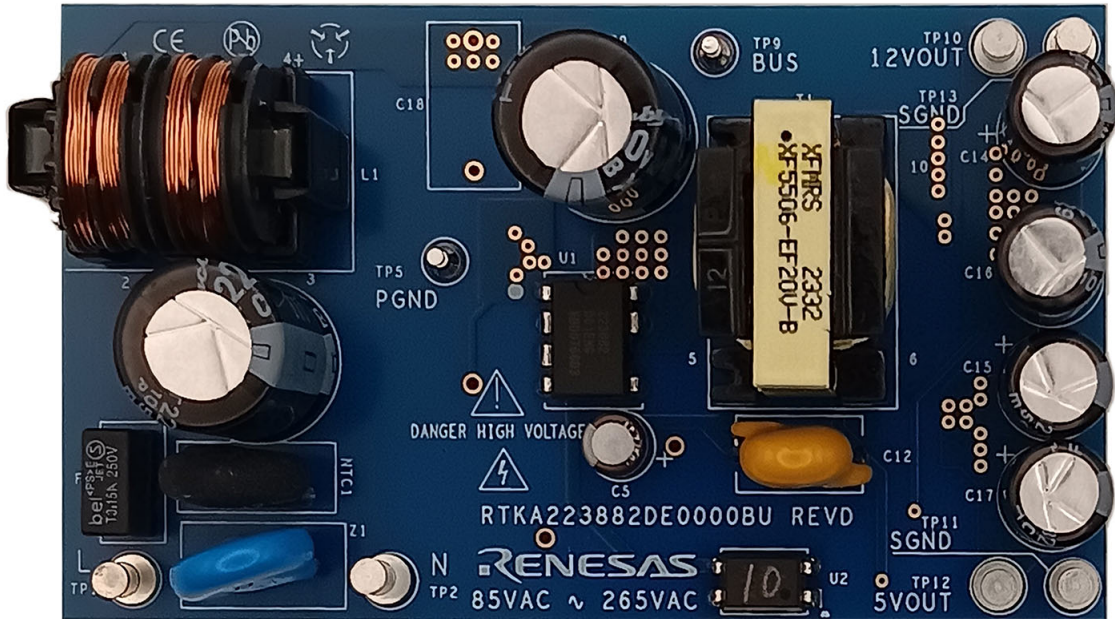

Figure 3. RTKA223882DE0000BU Evaluation Board (Top)

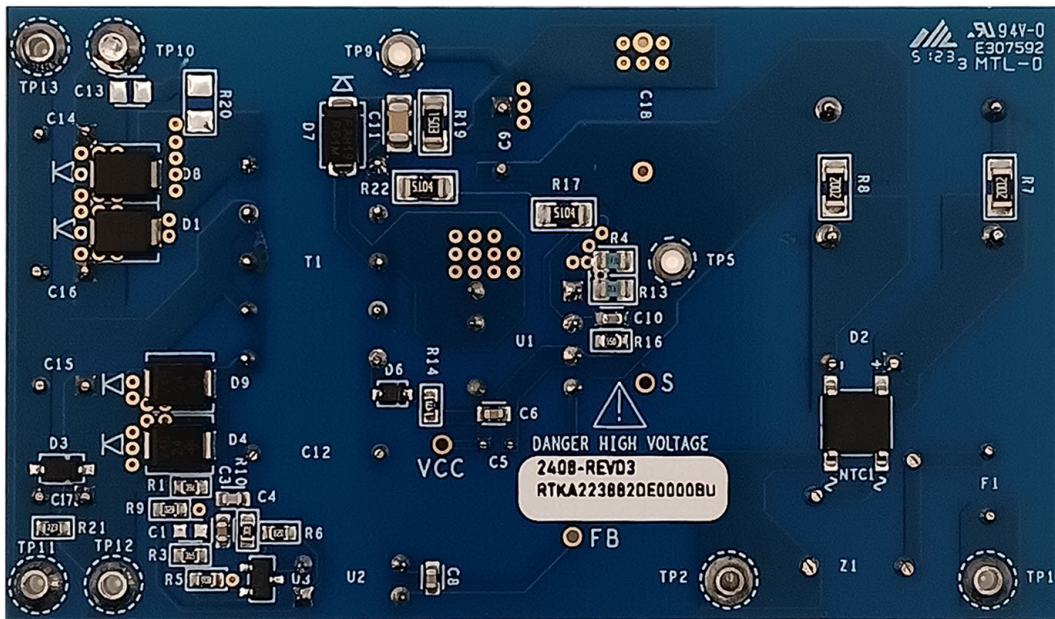

Figure 4. RTKA223882DE0000BU Evaluation Board (Bottom)

## 2.1 Schematic Diagrams

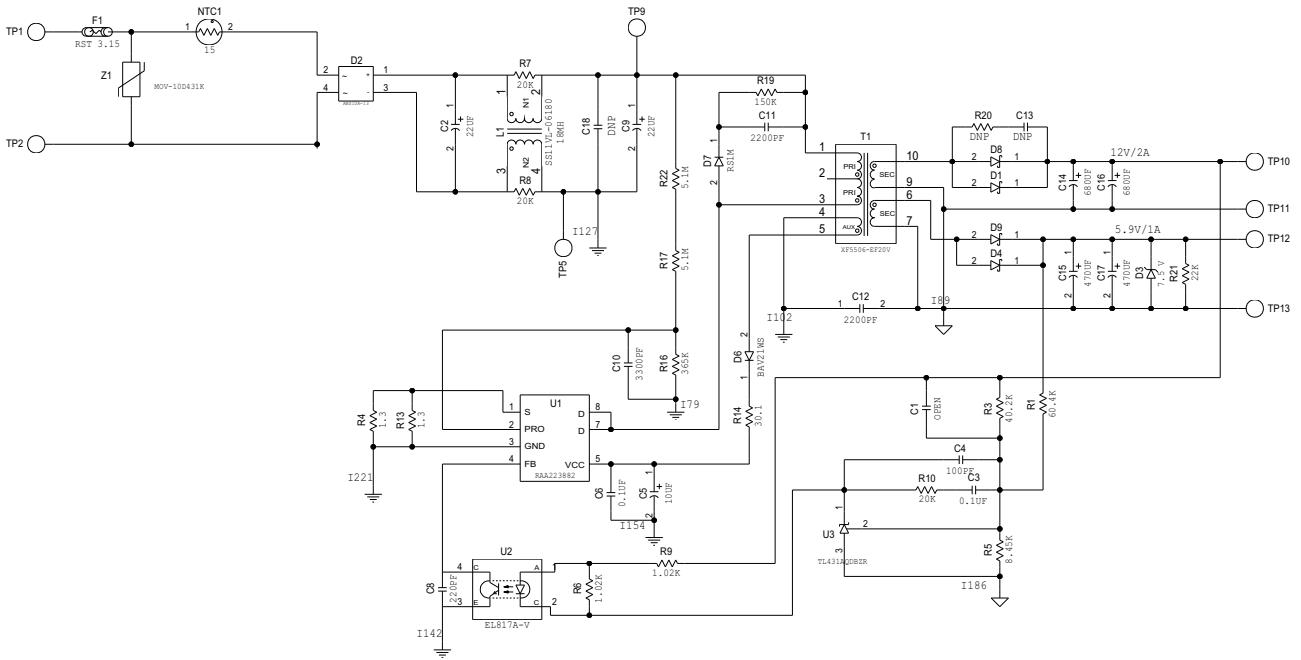

Figure 5. RTKA223882DE000BU Schematic

## 2.2 Bill of Materials

Designator	Qty	Description	Value	Manufacturer	Part Number
F1	1	Fuse	3.15A, 250V <sub>AC</sub> , Radial	Bel Fuse	RST 3.15
D2	1	1A 1000V Bridge Rectifier	1A, 1000V, ABS	Diodes Inc	ABS10A-13
D3	1	Zener Diode	7.5V, 6%, 200mA, SOD-123	Micro commercial	BZT52C7V5-TP
D6	1	General Purpose Diode	0.2A, 200V, SOD-323	Micro commercial	BAV21WS-TP
D7	1	Fast Recovery Diode	1A, 1kV, SMA	Onsemi	RS1M
D1, D8	4	SCHOTTKY RECTIFIER	5A, 100V, SMB	Diodes Inc	SDT5A100SB
D4, D9		SCHOTTKY RECTIFIER	1.9A, 100V, SMB	Vishay	VSSB410S
L1	1	Common Mode Choke	250V <sub>AC</sub> , 18mH, 600mA	KEMET	SS11VL-06180
C1	0	Do Not Populate	Do Not Populate	-	-
C3, C6	2	Multilayer Ceramic Cap	100nF, 10%, 50V, 0603	Various	Generic
C4	1	Multilayer Ceramic Cap	100pF, 10%, 50V, 0603	Various	Generic
C5	1	Aluminum Electrolytic Cap	10μF, 20%, 25V, 0603, Radial	Nichicon	UMV1E100MFD1TP
C2, C9	1	Aluminum Electrolytic Cap	22μF, 400V, 12khrs@105C, Radial	Rubycon	400BXC22MEFC12.5X20
C8	1	Multilayer Ceramic Cap	220pF, 10%, 50V, 0603	Various	Generic
C10	1	Multilayer Ceramic Cap	3300pF, 10%, 50V, 0603	Various	Generic
C11	1	Multilayer Ceramic Cap	2.2nF, 10%, 630V, 1206	MuRata	GRM31BR72J222KW01L

Designator	Qty	Description	Value	Manufacturer	Part Number
C12	1	Ceramic Disk Capacitor	2200pF, 20%, 500V <sub>AC</sub> , Class Y1	Vishay	VY1222M37Y5VQ63V0
C13	0	DNP	Do Not Populate	-	-
C18	0	DNP	Do Not Populate	-	-
C14, C16	2	Aluminum Electrolytic Cap	680μF, 25V, 9khrs at 105C, Radial	Panasonic	EEU-FR1E681L
C15, C17	2	Aluminum Electrolytic Cap	470μF, 16V, 7khrs at 105C, Radial	Rubycon	16YXJ470M8X11.5
R1	1	Thick Film Chip Resistor	60.4k, 1%, 1/10W, 0603	Various	Generic
R3	1	Thick Film Chip Resistor	40.2K, 1%, 1/10W, 0603	Various	Generic
R4, R13	2	Thick Film Chip Resistor	1.3, 1%, 1/4W, 0805	KOA	RK73H2ATTD1R30F
R5	1	Thick Film Chip Resistor	8.45K, 1%, 1/10W, 0603	Various	Generic
R6, R9	2	Thick Film Chip Resistor	1.02K, 1%, 1/10W, 0603	Various	Generic
R7, R8	2	Thick Film Chip Resistor	20k, 1%, 1/4W, 1206	Various	Generic
R10	1	Thick Film Chip Resistor	20K, 1%, 1/10W, 0603	Various	Generic
R14	1	Thick Film Chip Resistor	30.1, 1%, 1/10W, 0603	Various	Generic
R16	1	Thick Film Chip Resistor	365k, 1%, 1/10W, 0603	Various	Generic
R17, R22	2	Thick Film Chip Resistor	5.1M, 1%, 1/4W, 1206	Various	Generic
R19	1	Thick Film Chip Resistor	150k, 1%, 1/4W, 1206	Various	Generic
R20	0	DNP	Do Not Populate	-	-
T1	1	Transformer	550μH, 10%, 1.4A Isat, EF20, PTH	XFMRS	XF5506-EF20V-B
U1	1	700V Offline Flyback Regulator	RAA223882, DIP-7	Renesas	RAA2238824GSP#AA1
U2	1	Opto-coupler	CTR: 80-160, PTH	Lite-On	LTV-817-A
U3	1	Shunt Regulator	TL431, SOT23, 1%	Nexperia	TL431AQDBZR,215
Z1	1	Varistor	430V, 2.5KA, 10mm Disc, PTH	Bourns	MOV-10D431K

## 2.3 Transformer Specifications

The transformer for the EV board is a customized part by XFMRS, and has the following key characteristics:

- Low cost E22 core
- Meets 3.2mm clearance and creepage distance
- Reinforced insulation with triple insulated wires
- Isolation voltage: 3.6kVAC (3.6kVAC at 3s)
- Dual output
- Operating temperature: -40°C~+85°C
- RoHS and Halogen Free compliance

Figure 6 shows the XFMR5 Transformer specification and construction.

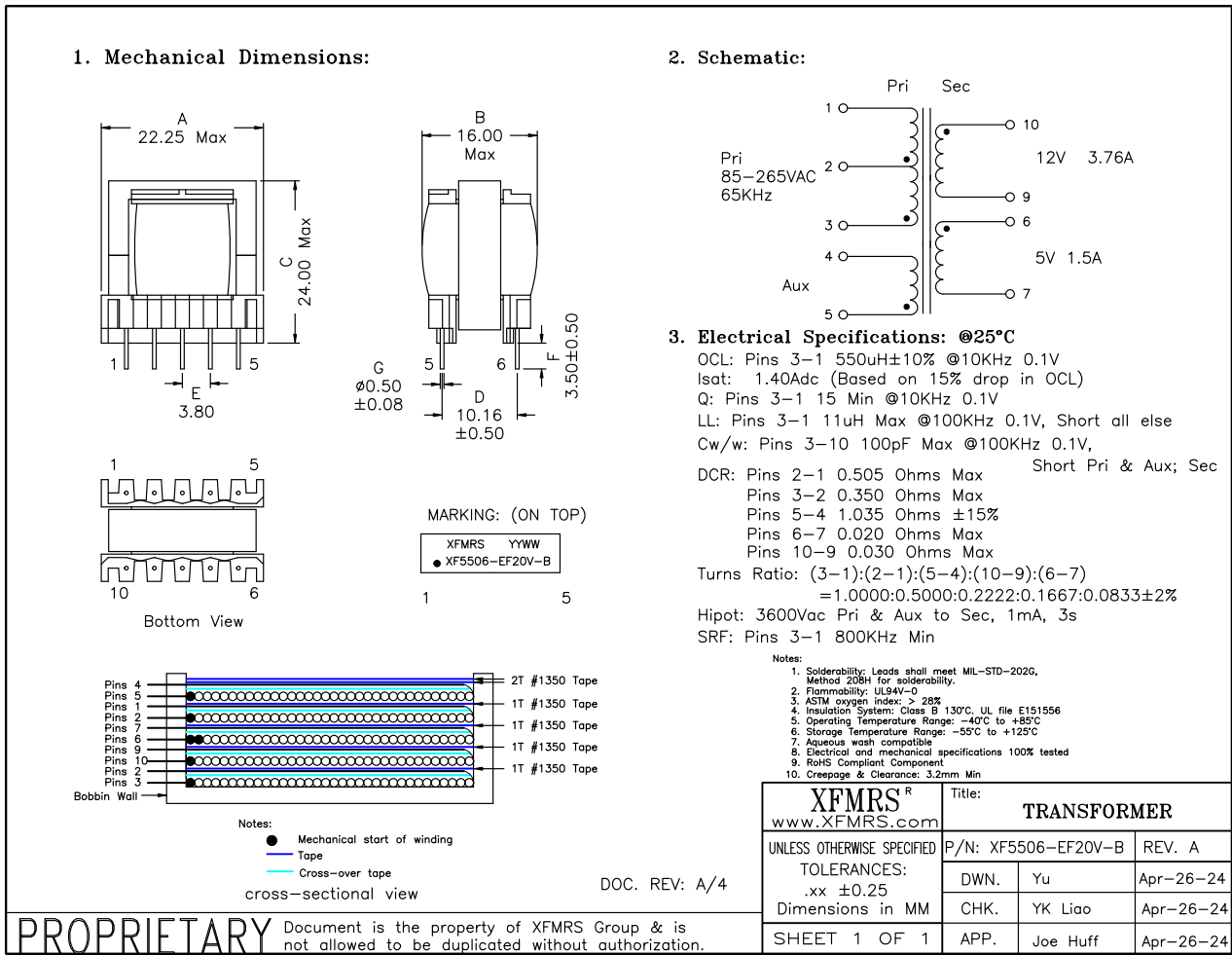

Figure 6. Transformer Specifications and Construction

## 2.4 Board Layout

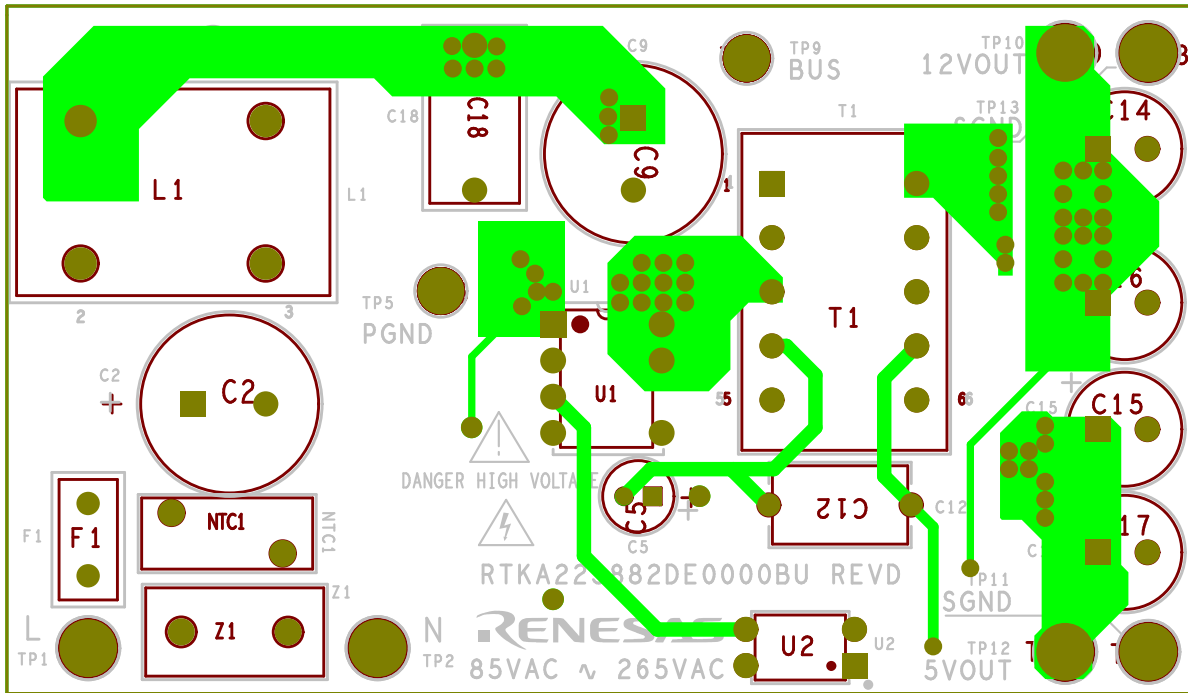

Figure 7. Top Layer

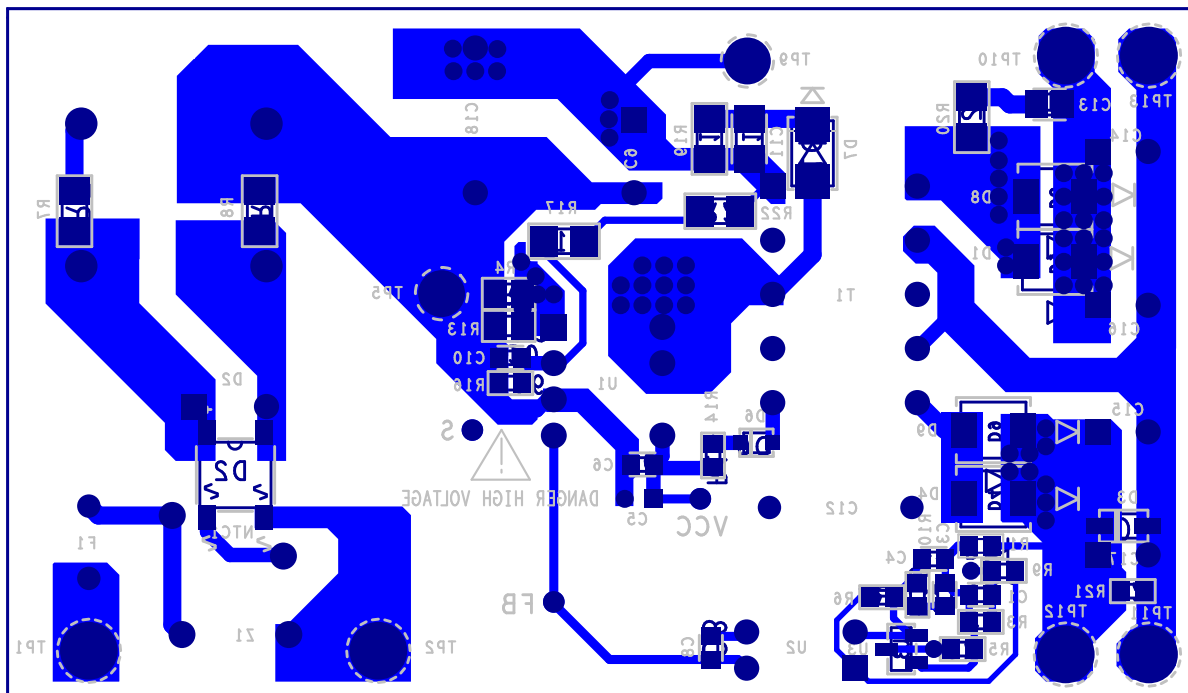

Figure 8. Bottom Layer

## 2.5 Layout Guidelines

For optimal design, refer to the PCB Layout Guidance section in the *RAA223882 Datasheet*.



### 3. Typical Performance

$V_{in} = 120V_{AC} \sim 230V_{AC}$ ,  $V_{O1} = 12V$ ,  $I_{O1} = 2A$  (max),  $V_{O2} = 5.9V$ ,  $I_{O2} = 1A$  (max),  $T_A = +25^{\circ}C$

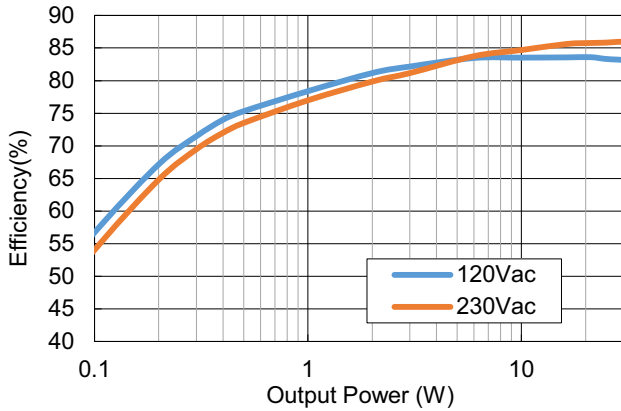

Figure 9. Efficiency Over Load Range

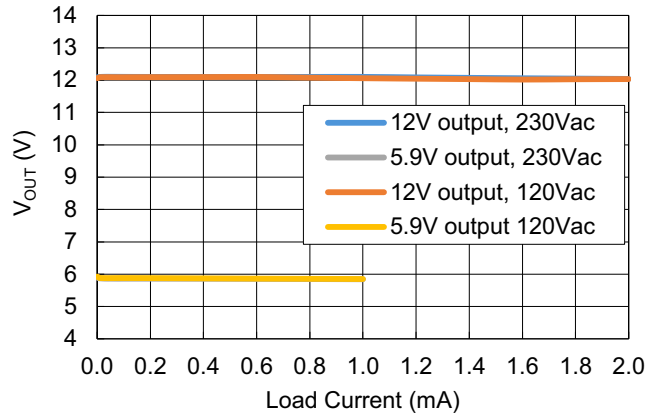

Figure 10. Load Regulation

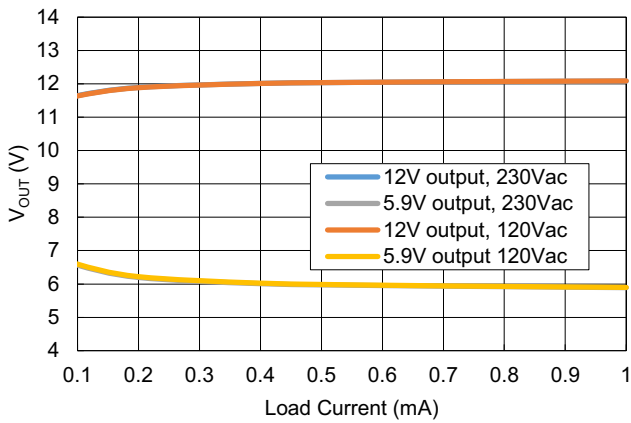

Figure 11. Load Regulation with 5.9V Load Sweep

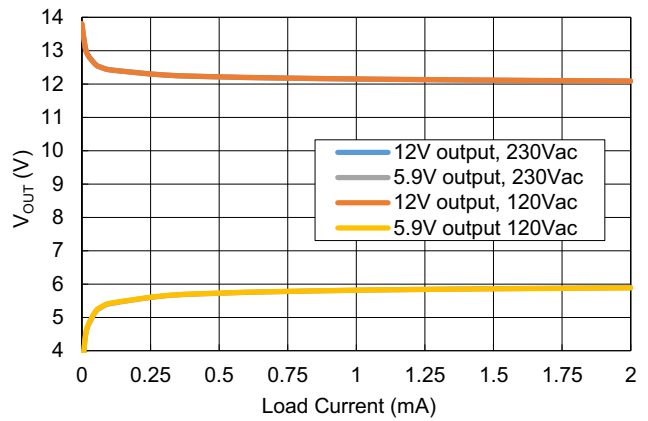

Figure 12. Load Regulation with 12V Load Sweep

Table 1. Typical No-load Power Consumption (25°C Ambient)

Input Voltage	No-Load Power	300mW Load Power
120V <sub>AC</sub> /60Hz	65mW	420mW
230V <sub>AC</sub> /50Hz	110mW	431mW

### 3.1 EMI Test Results

RTKA223882DE000BU is compliant to the conducted EMI requirements of FCC Part 15 and CISPR22 Class B.

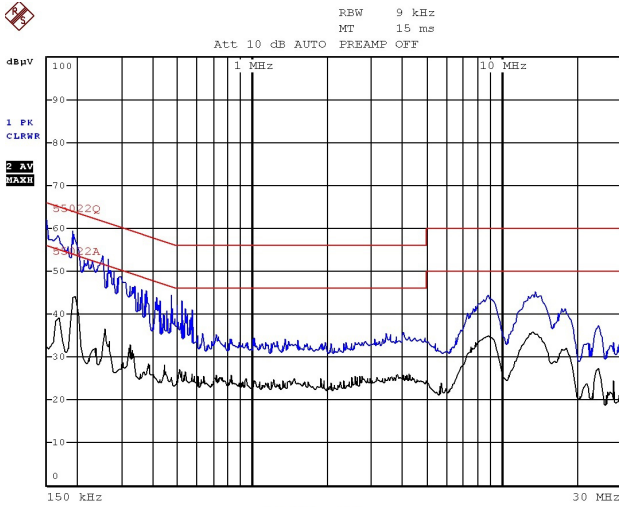

Figure 13. 120V<sub>AC</sub> Line

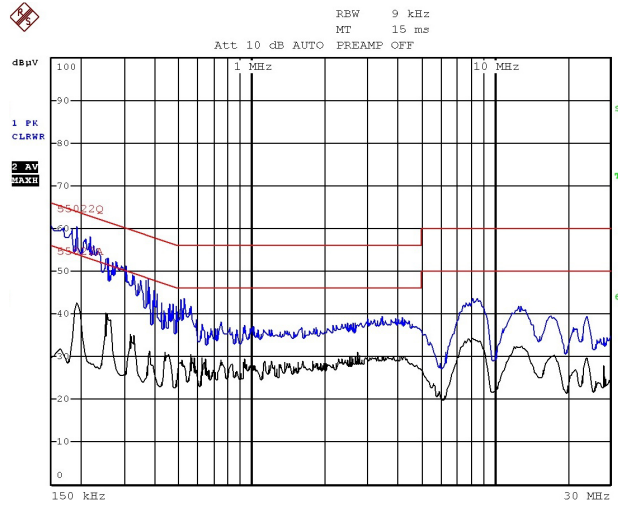

Figure 14. 120V<sub>AC</sub> Neutral

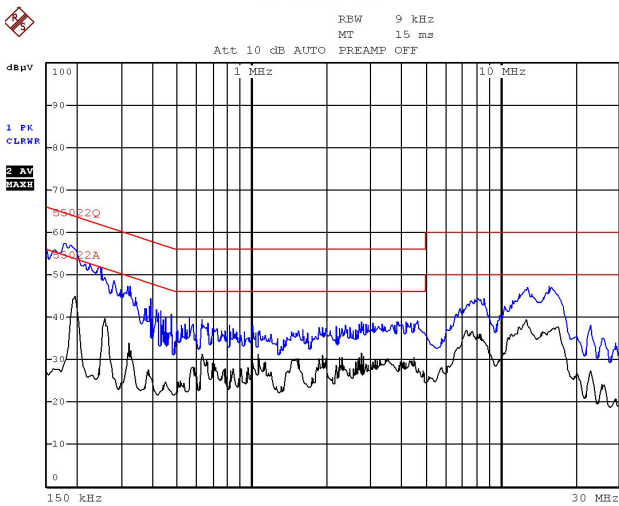

Figure 15. 230V<sub>AC</sub> Line

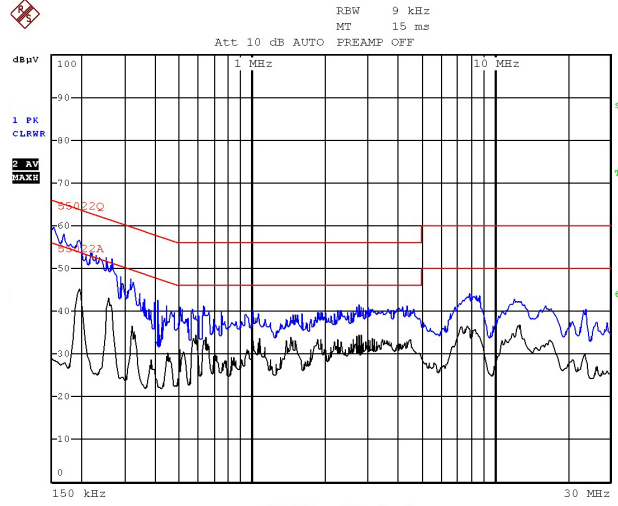

Figure 16. 230V<sub>AC</sub> Neutral

## 4. Ordering Information

Part Number	Description
RTKA223882DE0000BU	RAA223882 Evaluation Board

## 5. Revision History

Revision	Date	Description
1.00	May 8, 2024	Initial release

## IMPORTANT NOTICE AND DISCLAIMER

RENESAS ELECTRONICS CORPORATION AND ITS SUBSIDIARIES (“RENESAS”) PROVIDES TECHNICAL SPECIFICATIONS AND RELIABILITY DATA (INCLUDING DATASHEETS), DESIGN RESOURCES (INCLUDING REFERENCE DESIGNS), APPLICATION OR OTHER DESIGN ADVICE, WEB TOOLS, SAFETY INFORMATION, AND OTHER RESOURCES “AS IS” AND WITH ALL FAULTS, AND DISCLAIMS ALL WARRANTIES, EXPRESS OR IMPLIED, INCLUDING, WITHOUT LIMITATION, ANY IMPLIED WARRANTIES OF MERCHANTABILITY, FITNESS FOR A PARTICULAR PURPOSE, OR NON-INFRINGEMENT OF THIRD-PARTY INTELLECTUAL PROPERTY RIGHTS.

These resources are intended for developers who are designing with Renesas products. You are solely responsible for (1) selecting the appropriate products for your application, (2) designing, validating, and testing your application, and (3) ensuring your application meets applicable standards, and any other safety, security, or other requirements. These resources are subject to change without notice. Renesas grants you permission to use these resources only to develop an application that uses Renesas products. Other reproduction or use of these resources is strictly prohibited. No license is granted to any other Renesas intellectual property or to any third-party intellectual property. Renesas disclaims responsibility for, and you will fully indemnify Renesas and its representatives against, any claims, damages, costs, losses, or liabilities arising from your use of these resources. Renesas' products are provided only subject to Renesas' Terms and Conditions of Sale or other applicable terms agreed to in writing. No use of any Renesas resources expands or otherwise alters any applicable warranties or warranty disclaimers for these products.

(Disclaimer Rev.1.01 Jan 2024)

### Corporate Headquarters

TOYOSU FORESIA, 3-2-24 Toyosu,  
Koto-ku, Tokyo 135-0061, Japan  
[www.renesas.com](http://www.renesas.com)

### Trademarks

Renesas and the Renesas logo are trademarks of Renesas Electronics Corporation. All trademarks and registered trademarks are the property of their respective owners.

### Contact Information

For further information on a product, technology, the most up-to-date version of a document, or your nearest sales office, please visit [www.renesas.com/contact-us/](http://www.renesas.com/contact-us/).