

RTKA489000DE0000BU

The [RAA489000](#) is a digitally configurable buck-boost battery charger with USB-C® Port Controller (TCPC). The battery charging function supports Narrow Voltage Direct Charging (NVDC) and USB Power Delivery (PD) programmable power supply output supplies. The TCPC controller integrates TCPC PHY, CC-Logic, and VCONN switches. All RAA489000 blocks connected to the adapter/USB pin (CC1, CC2, VBUS) are protected from input overvoltage events up to 28V. The back-to-back NFET driver and VBUS self-discharge control further simplify the USB PD designs.

The RAA489000 supports reverse buck, boost, or buck-boost operation to the adapter port (OTG mode) from 2- to 4-cell batteries that allow configurations to support USB PD output for Programmable Power Supply (PPS) ports. Because of the on-chip TCPC and Renesas advanced R3™ Technology, RAA489000 is fully compliant with USB PD Sink Fast Role Swap (FRS) specification by monitoring CC line and bringing VBUS voltage back to a safe range rapidly. The RAA489000 has dual SMBus/I²C ports supporting simultaneous direct charger function programming and CC line traffic through TCPCI, when operating with a USB-C Port Manager (TCPM) such as the Renesas R9A02G015, to form a complete USB PD compliant solution for single-port or multi-port applications.

The RAA489000 battery charger supports all NFETs solution and supports system power from the adapter, battery, or a combination of both. The on-chip ADC monitors the charging input voltage/current, battery voltage, charging/discharging current, and the battery temperature. For Intel™ IMVP compliant systems, the RAA489000 includes PROCHOT#.

The RTKA489000DE0000BU evaluation board is designed to demonstrate the performance of the RAA489000. From the PROG pin to GND, the resistor can be used to program the default value numbers of the battery in series, the switching frequency, and the adapter current limit charging function. The default value numbers can also be set by SMBus.

Features

- Buck-Boost NVDC charger for 2-, 3-, or 4-cell Li-ion batteries using all NFET transistors
- USB-C Port Controller (TCPC) with integrated TCPC PHY, CC-Logic
- Dual SMBus/I²C ports for charger programming and CC line traffic
- Internal 500mΩ VCONN MUX for up to 1.6A
- Input voltage range: 3.9V to 23.4V (no dead zone)
- System/battery output voltage: 3.9V to 18.304V
- 28V protection for CC1/CC2/VBUS
- Adapter Crash Prevention with adapter current and battery current regulation
- PROCHOT# IMVP compliant
- Support Intel VMIN Active Protection (VAP)
- Internal 8-bit ADC for charger operation telemetry
- Software configurable for DFP, UFP, or DRP
- USB-C PD Sink Fast Role Swap (FRS) and PPS support
- Pass-Through-Mode (PTM) in forward direction
- Battery Ship mode - IC ultra-low power state
- Supports JEITA compliance autonomous charge
- Dynamic Voltage Compensation (DVC) support for multi-port charging applications
- USB Power Delivery (PD) 3.0 and Programmable Power Supply (PPS) certified
- 5x5 40 Ld QFN package
- UL 2367, IEC 62368-1: File No. E520109

Specifications

- V_{IN} = 3.9V to 23.4V (no dead zone)
- V_{OUT} = 3.9V to 18.304V
- MAX charge current up to 6A

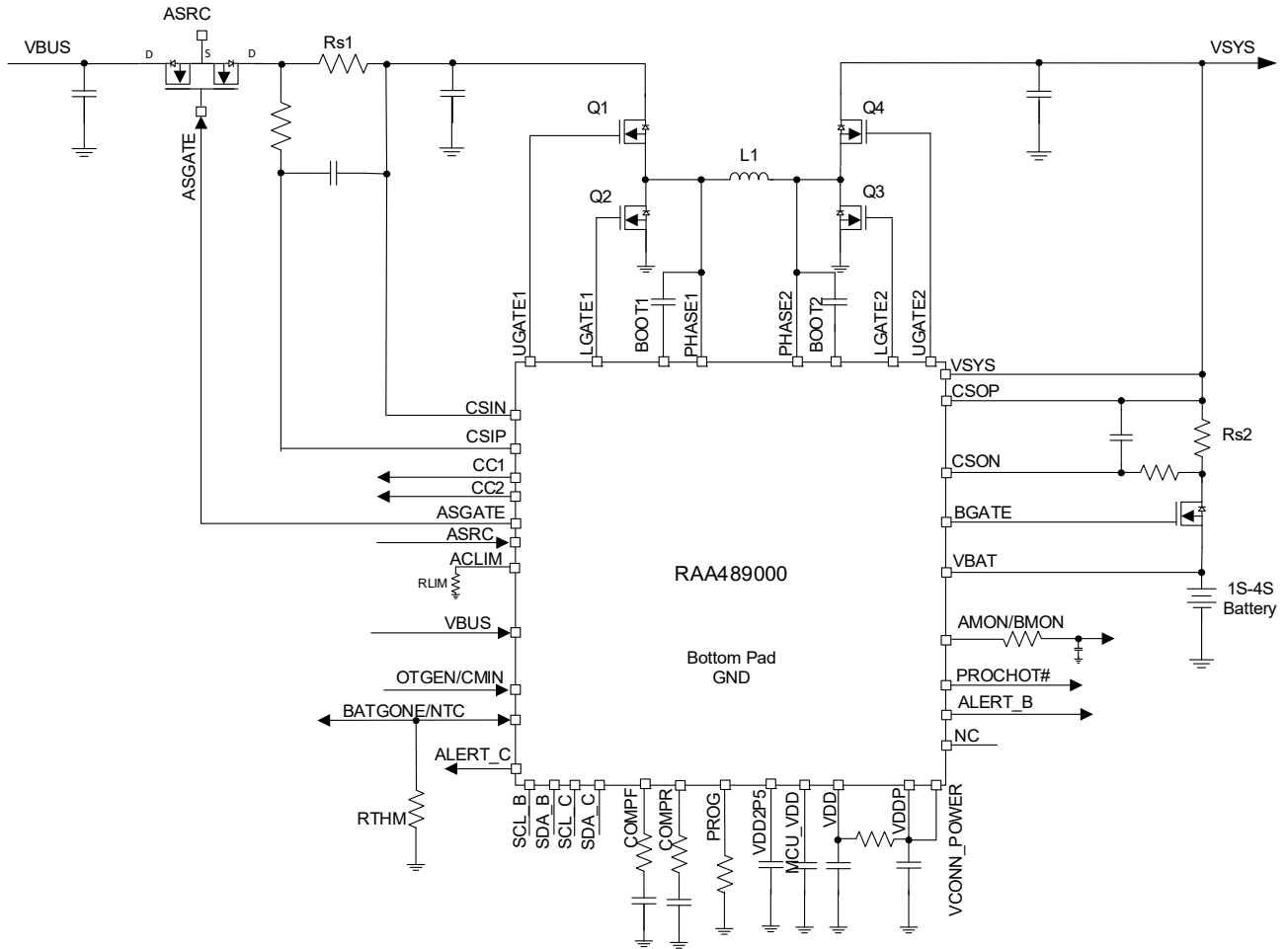

Figure 1. RTKA489000DE0000BU Application Diagram

Contents

1. Installing the RAA489000 Software	4
1.1 Required Hardware	4
1.2 Required Software	4
1.3 Installing the GUI	4
1.4 Installing the USB Driver	5
2. Using the GUI	7
2.1 Setting the USB Connection	7
2.2 Starting the GUI	7
2.3 Troubleshooting the GUI	8
3. Functional Description	8
3.1 Recommended Equipment	8
3.2 Quick Start Guide	8
3.3 Regulating System Voltage	9
3.4 Regulating Input Current Limit	9
3.5 Configuring the RTKA489000DE0000BU for Charging Mode	10
3.6 Configuring the RTKA489000DE0000BU for Trickle Charging Mode	11
3.7 Configuring the RTKA489000DE0000BU for OTG Mode	11
3.8 Configuring the RTKA489000DE0000BU as Source	13
3.9 Configuring the RTKA489000DE0000BU as Sink	15
4. Board Design	16
4.1 PCB Layout Guidelines	16
4.2 Schematics Drawings	20
4.3 Bill of Materials	22
4.4 Board Layout	27
5. Typical Performance	37
6. Ordering Information	40
7. Revision History	40

1. Installing the RAA489000 Software

The RAA489000 Control Software communicates with the RAA489000 controller using the USB to on-board SMBus Graphical User Interface (GUI). The GUI facilitates access to the RAA489000 SMBus registers.

This section describes how to install, start, and use the GUI.

1.1 Required Hardware

- RTKA489000DE0000BU evaluation board
- USB 2.0 A/B cable

1.2 Required Software

The software Installation Wizard package includes all three required components:

- RAA489000 SMBus Control Tool
- National Instruments Runtime VISA Engine
- USB interface module driver

1.3 Installing the GUI

Both the RAA489000 Control Software and the National Instruments Runtime Engine are installed automatically from the installation wizard.

Note: Close all other applications before this installation and reboot the computer when the installation is complete.

1. Extract the zip file to the local drive, not the network drive. Network security prohibits the .inf file from being copied onto the network.
2. Run **autorun.exe**. The menu in [Figure 2](#) appears.

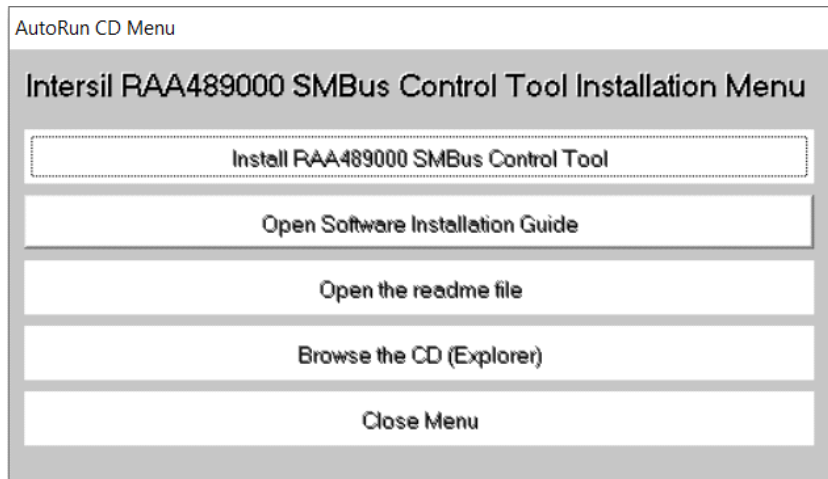

Figure 2. RAA489000 SMBus Control Tool Installation Wizard

3. Click **Install RAA489000 SMBus Control Tool**.
 - a. The window shown in [Figure 3](#) appears. Click **Next**.

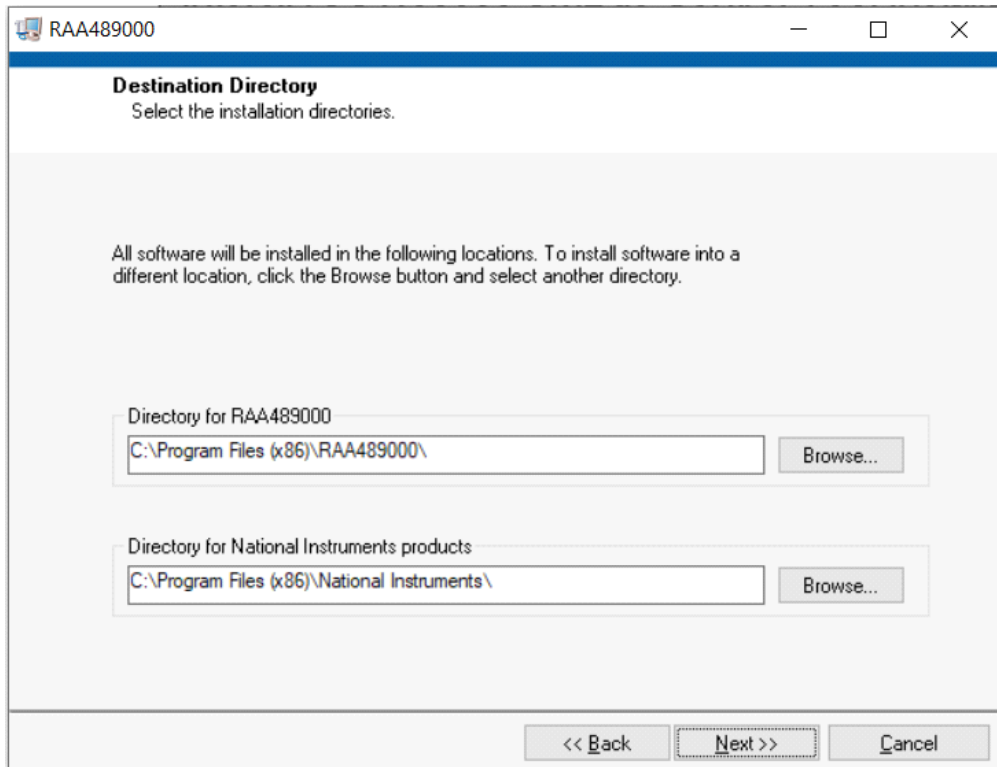

Figure 3. RAA489000 Control Software Installer

4. Follow the instructions to accept the two End User License Agreements to complete the software installation.
5. Click **Close Menu** from the installation wizard.

1.4 Installing the USB Driver

This process explains how to install the SMBus to USB interface driver.

The driver supports Microsoft Vista, Windows 7, Windows 8, Windows 8.1, and Windows 10 operating systems.

Note: If you installed the driver or certificate previously, skip this section.

1. Open the installation wizard package.
2. Navigate to **USB-I2C Driver**. Right-click the **SMBus-USB-Win10.inf** file and select **Install**.

Note: Install the driver from the local drive. The driver installation fails because of network security if you install from the network drive.

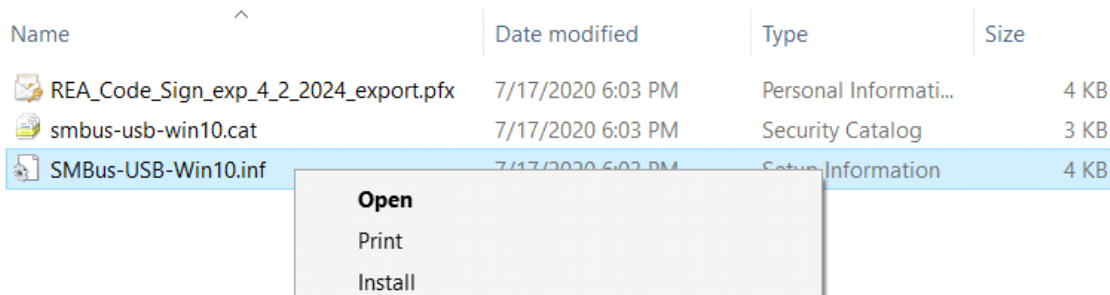

Figure 4. RAA489000 USB Driver Location

3. The message in [Figure 5](#) appears when the driver is successfully installed.

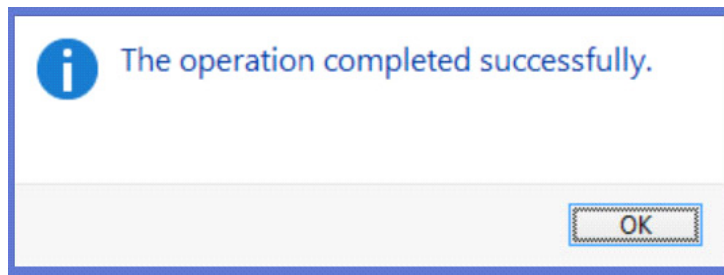

Figure 5. RAA489000 Successful Driver Installation

4. If the installation fails the Digital Signature required in Windows 10 or security settings, complete the following steps to bypass it.

Note: To complete the process, print and complete the following steps. The system restarts and these instructions are needed.

5. Open the **Command Prompt** from the Start menu.
6. Enter the command **shutdown /r /o /f /t 00** in the Command Prompt.
7. Click **OK**.
8. The system restarts to the **Choose an option** screen.
9. Select **Troubleshoot** from the **Choose an option** screen.
10. Select **Advanced options** from the **Troubleshoot** screen.
11. Select **Windows Startup Settings** from the **Advanced options** screen.
12. Click **Restart**.
13. The system restarts to the **Advanced Boot Options** screen.
14. Select **Disable Driver Signature Enforcement**.
15. Restart and install the drivers.

2. Using the GUI

The RAA489000 SMBus Control Tool Software must be installed to use the evaluation system. Do not connect the RTKA489000DE0000BU evaluation board to the USB port until installation is complete.

Connect the RTKA489000DE0000BU to a power supply before using the SMBus GUI.

2.1 Setting the USB Connection

Connect the USB cable from the USB port of the computer to connector J20 of the RTKA489000DE0000BU.

2.2 Starting the GUI

To start the GUI, navigate to the **Start** menu, then select **All Programs** → **Renesas** → **RAA489000 SMBus Control Tool**.

Figure 6 shows the GUI.

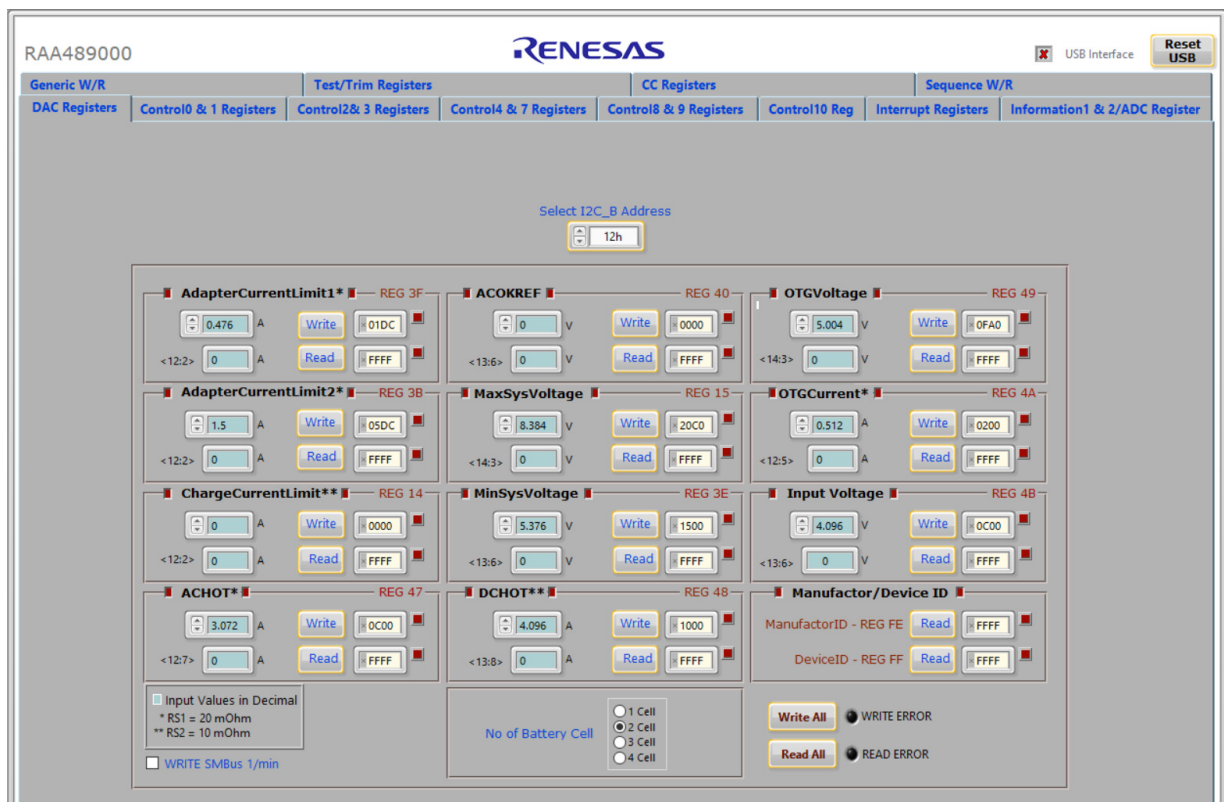

Figure 6. RAA489000 Graphical User Interface

2.3 Troubleshooting the GUI

Check the status of the USB interface at the top of the GUI. If the USB communication is OK, the **USB Interface** status shows a green check mark, as seen in [Figure 6](#).

If the **USB Interface** status shows a red X, the computer cannot establish the connection. Complete the following steps to troubleshoot:

1. Ensure the driver files for the USB interface are installed correctly. The driver files are in the **USB-I2C Driver** folder.
2. Check the USB cable connections from the RTKA489000DE0000BU to the USB port of the computer.
3. Try different sequences: plug in the RTKA489000DE0000BU first or start the GUI first.

If the problem continues, the USB driver may not be properly installed; therefore, the RTKA489000DE0000BU is not recognized. See [Installing the USB Driver](#) for driver installation instructions.

3. Functional Description

The RTKA489000DE0000BU evaluation board provides all circuits required to evaluate the features of the RAA489000. Most of the features of the RAA489000 are available on the RTKA489000DE0000BU, such as adjustable output voltage, On-the-Go (OTG) mode, Trickle Charging mode for a depleted battery, and system power monitor at Buck, Boost, and Buck-Boost modes.

3.1 Recommended Equipment

- 0V to 25V power supply with at least 6A source current capability
- Electronic load capable of sinking current up to 6A
- Battery emulator capable of sinking and sourcing current up to 6A
- Digital Multimeters (DMMs)
- 100MHz quad-trace oscilloscope

Note: You can use a power supply (that can source but cannot sink current) in parallel with an e-load Constant Current (CC) mode to emulate the battery. For example, when charging, set the charging current command lower than the CC mode e-load. If the e-load CC mode current is set at 3A, the charge current command is 2A and the e-load takes 2A from the charger and another 1A from the power supply in parallel with it. When discharging, the power supply acts just like the battery to discharge current. You can also use the e-load Constant Voltage (CV) mode to emulate the battery to take the charging current from the charger and set the e-load CV voltage below the MaxSysV register setting. However, this e-load CV mode cannot source current like a battery.

3.2 Quick Start Guide

The number of battery cell and adapter current limit default values can be configured with a standard 1% 0603 resistor (R23a) from the PROG pin to GND. The *PROG Pin Programming Table* in the RAA489000 datasheet shows the programming options. After the default number of cells in series is set, the default values for MaxSystemVoltage and MinSystemVoltage are set accordingly. These values can also be changed through the SMBus control registers, which are implemented with the Renesas GUI shown in [Figure 8](#). The three LEDs indicate the PROCHOT, ALERT_B, and ALERT_C status, respectively. For more details about the functions of these three pins, see the RAA489000 datasheet.

Complete the following steps to evaluate the RAA489000 key functions, including system voltage regulation, input current limit regulation, Charging mode, trickle Charging mode, and OTG mode. [Figure 7](#) shows the top view of the RTKA489000DE0000BU and highlights the key testing points and connection terminals. For more information about the RAA489000, including other operation modes, see the RAA489000 datasheet.

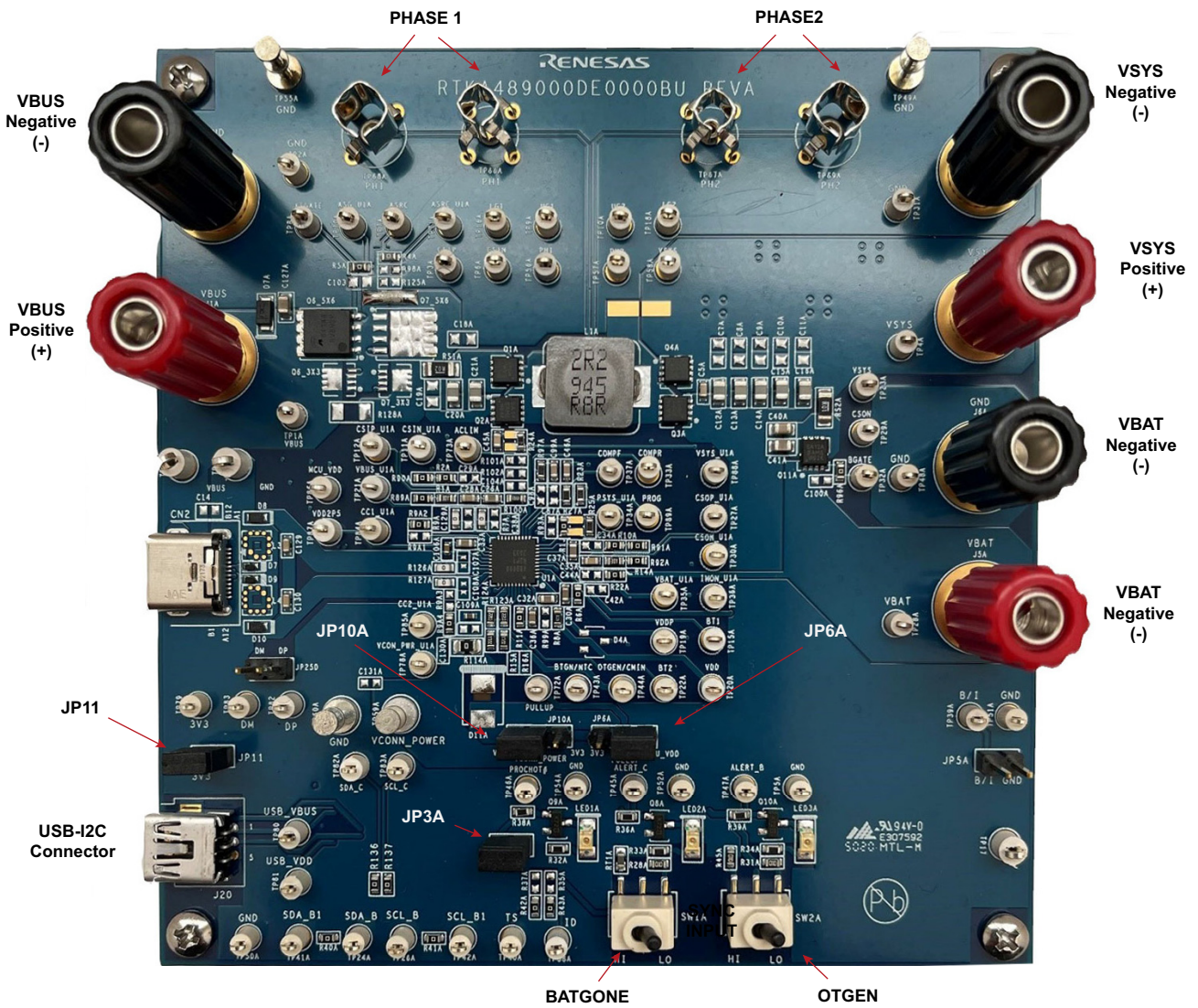

Figure 7. RTKA489000DE0000BU Connections

3.3 Regulating System Voltage

1. Set the power supply to 5V. With the output disabled, connect the (+) end to J1A and the (-) end to J2A.
2. Ensure jumpers JP3A and JP11 are shorted. Connect Jumper JP10A between VCONN_POWER and VDDP. Connect Jumper JP6A connect between PULL_UP and 3V3. Keep the Jumpers JP25D and JP5A open or NC. Switch SW1 and SW2 to the low position.
3. Turn on the power supply and measure VSYS using the DMM across (+) and (-). VSYS should read 8.38V. The current meter on the supply should read <100mA. Increase VIN from 5V to 15V slowly. Monitor PH1 and PH2 to observe seamless switching from Boost mode to Buck-Boost mode and finally into Buck mode.

3.4 Regulating Input Current Limit

1. Keep VIN as a constant value between 3.9V and 23.4V. Set the battery emulator voltage to 7.8V and connect the battery emulator output to battery leads J5A and J6A.
2. Turn on the battery emulator; there is no charge and discharge current for the battery, which is consistent with BGATE FET being off.

3. Add an electrical load on VSYS and GND terminals J3A and J4A. Turn on the load and increase the electrical load slowly; the input current increases correspondingly and VSYS keeps stable at 8.38V. The output voltage (VSYS) starts dropping as the input current reaches the 0.476A input current limit. For the input current limit details, see the RAA489000 datasheet. If the VSYS voltage is 150mV lower than the battery voltage, the BGATE FET turns on at a low voltage level so that the battery supplies the current to the load.

3.5 Configuring the RTKA489000DE0000BU for Charging Mode

1. Set the power supply to a constant value between 3.9V and 23.4V, then complete Steps 1 and 2 in [Regulating System Voltage](#). Ensure the input current does not exceed the limit.
2. Set the battery emulator voltage to 7.8V and connect the battery emulator output to battery leads J5A and J6A.
3. Connect the USB cable at the USB port for the SMBus.
4. Turn on the power supply. Turn on the battery emulator and open the Renesas RAA489000 GUI ([Figure 8](#)).

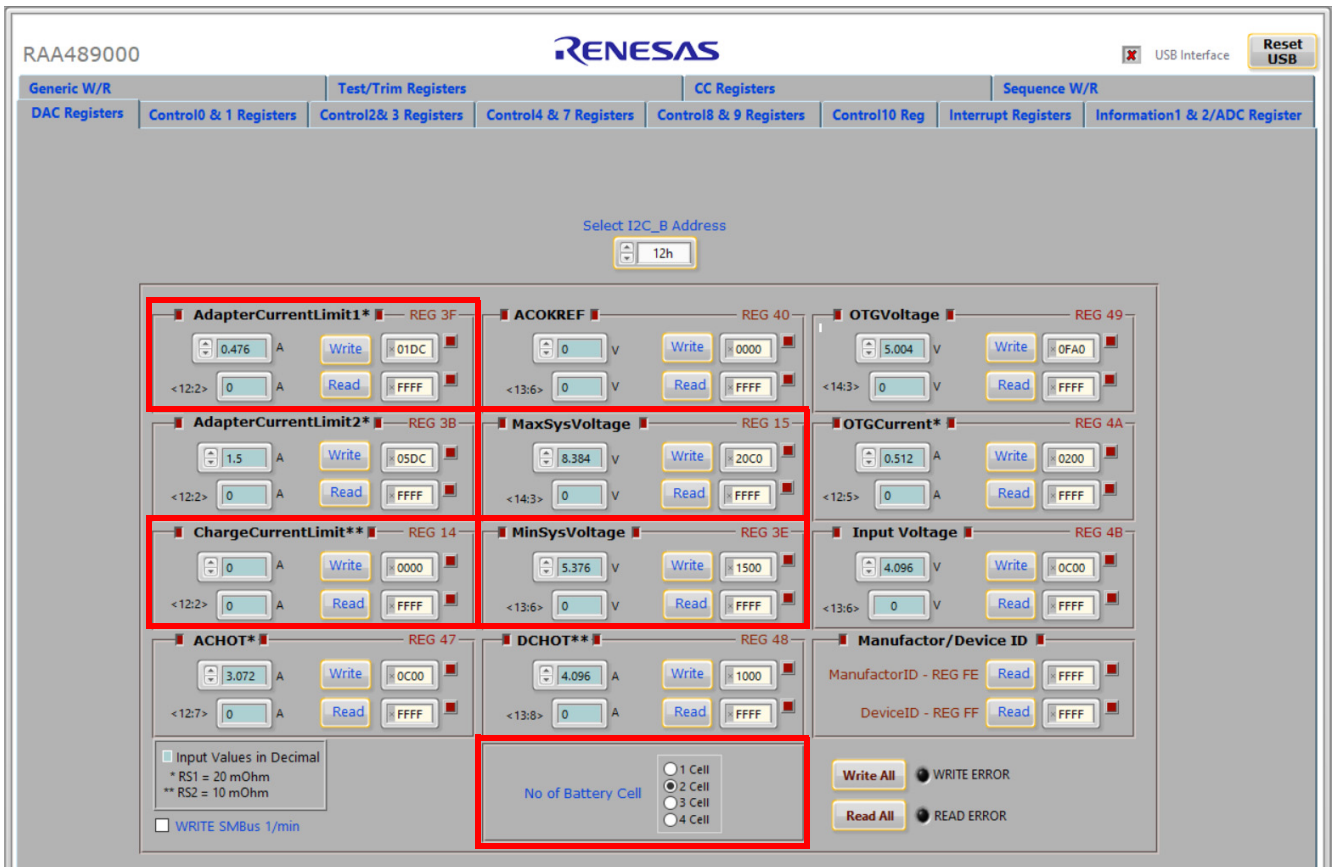

Figure 8. RAA489000 GUI

Note: A green check mark in the **USB Interface** status indicates the GUI is ready to communicate with the RTKA489000DE0000BU. If the **USB Interface** shows a red X, the GUI is not ready to communicate with the RTKA489000DE0000BU. Click the **Reset USB** button until a green check mark appears in the **USB Interface**. If the green check mark does not appear, check the USB connection. See [Troubleshooting the GUI](#) for troubleshooting information.

5. Select **2 Cell** in the **No of Battery Cell** section and click the **Write All** button. All controller register values are set to the default values correspondingly. The system voltage is 8.4V, which is the value of **MaxSysVoltage** in the GUI. There is no charge and discharge current for the battery. Set the minimum system voltage (**MinSysVoltage**) to a non zero value. Change the charge current limit (**ChargeCurrentLimit**) from 0A to 2A and click **Write**. The battery is now in 2A current charge operation. The charge current value can be monitored

in the GUI by clicking **Read** in the **ChargeCurrentLimit** column. Monitor the BGATE signal status to confirm the battery is in Charging mode.

6. To turn on charging (trickle and fast/normal), set the **MinSysVoltage** register and the **ChargeCurrentLimit** register to non-zero values.

Note: Ensure the input current does not reach the input current limit value, especially for a small VIN input.

3.6 Configuring the RTKA489000DE0000BU for Trickle Charging Mode

1. Complete steps 1 through 5 in [Configuring the RTKA489000DE0000BU for Charging Mode](#) without any changes. Set the **MinSysVoltage** register and the **ChargeCurrentLimit** register to non-zero values.
2. Decrease the battery emulator voltage and monitor the battery charging current. If the battery emulator voltage is less than 5.2V (lower than **MinSysVoltage**), the battery enters trickle Charging mode and the charge current decreases to 0.128A. The trickle charge current value can be changed through the SMBus control registers (see the RAA489000 datasheet).

Note: Ensure the input current does not reach the input current limit value, especially for small VIN input.

3.7 Configuring the RTKA489000DE0000BU for OTG Mode

1. Set the battery emulator voltage at a constant value between 5.8V and 15V. Connect battery leads J5A and J6A with the output disabled.
2. Connect an electric load on supply leads J1A and J2A with the output disabled.
3. Connect the USB cable at the USB port for SMBus. Turn on the battery emulator and electrical load without adding any load.
4. Open the RAA489000 GUI. **OTGVoltage** is the voltage value for the load side, as shown in [Figure 9](#), and **OTGCurrent** is the OTG output current limit at the load side. You can set these values as needed within the output limit range. See the RAA489000 datasheet for the limit ranges.

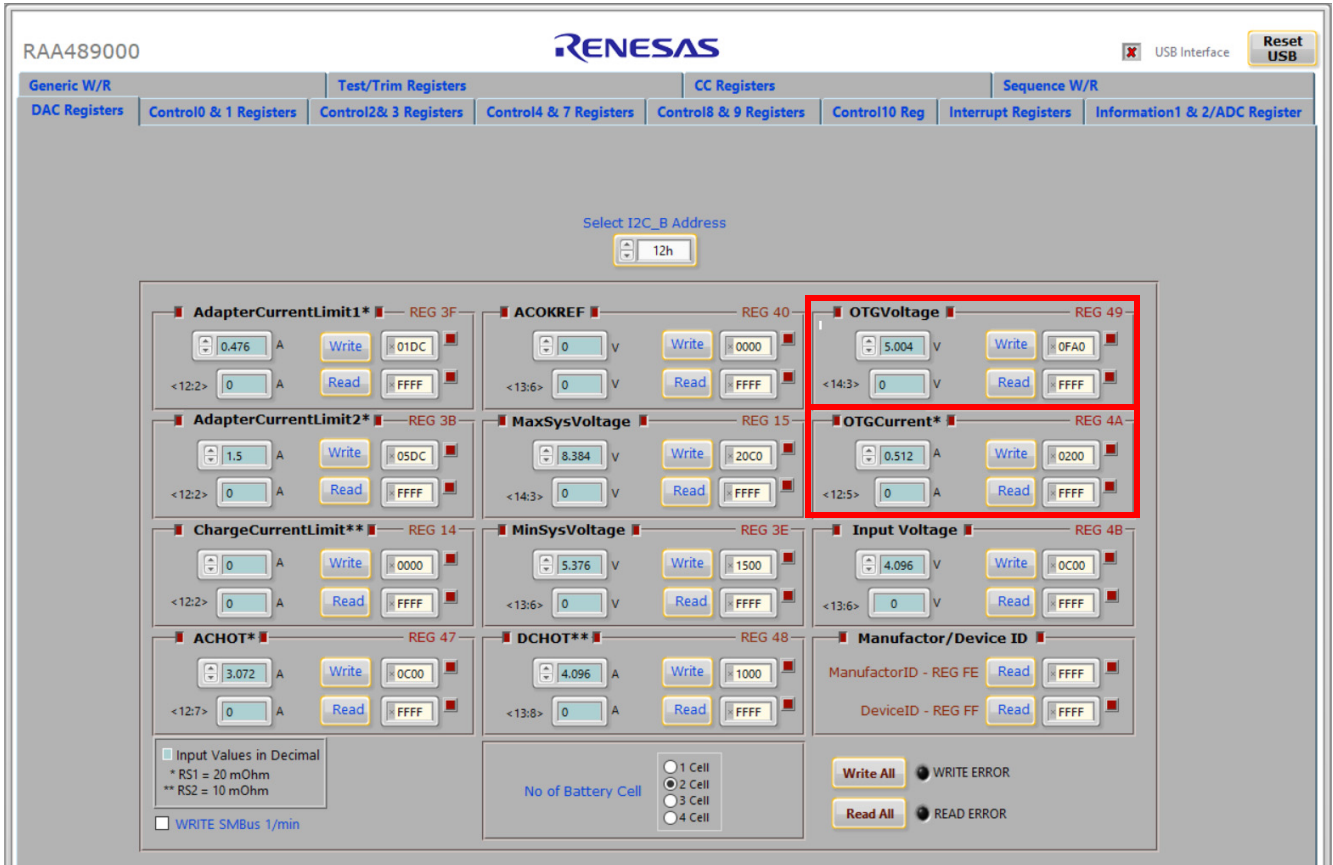

Figure 9. OTGVoltage and OTGCurrent Settings in GUI

5. Select the **Control0 & 1 Registers** tab.
6. In the **Control1 Register** column, select **1: Enable** in **OTG Function** to enable OTG, then click **Write**. See [Figure 10](#).

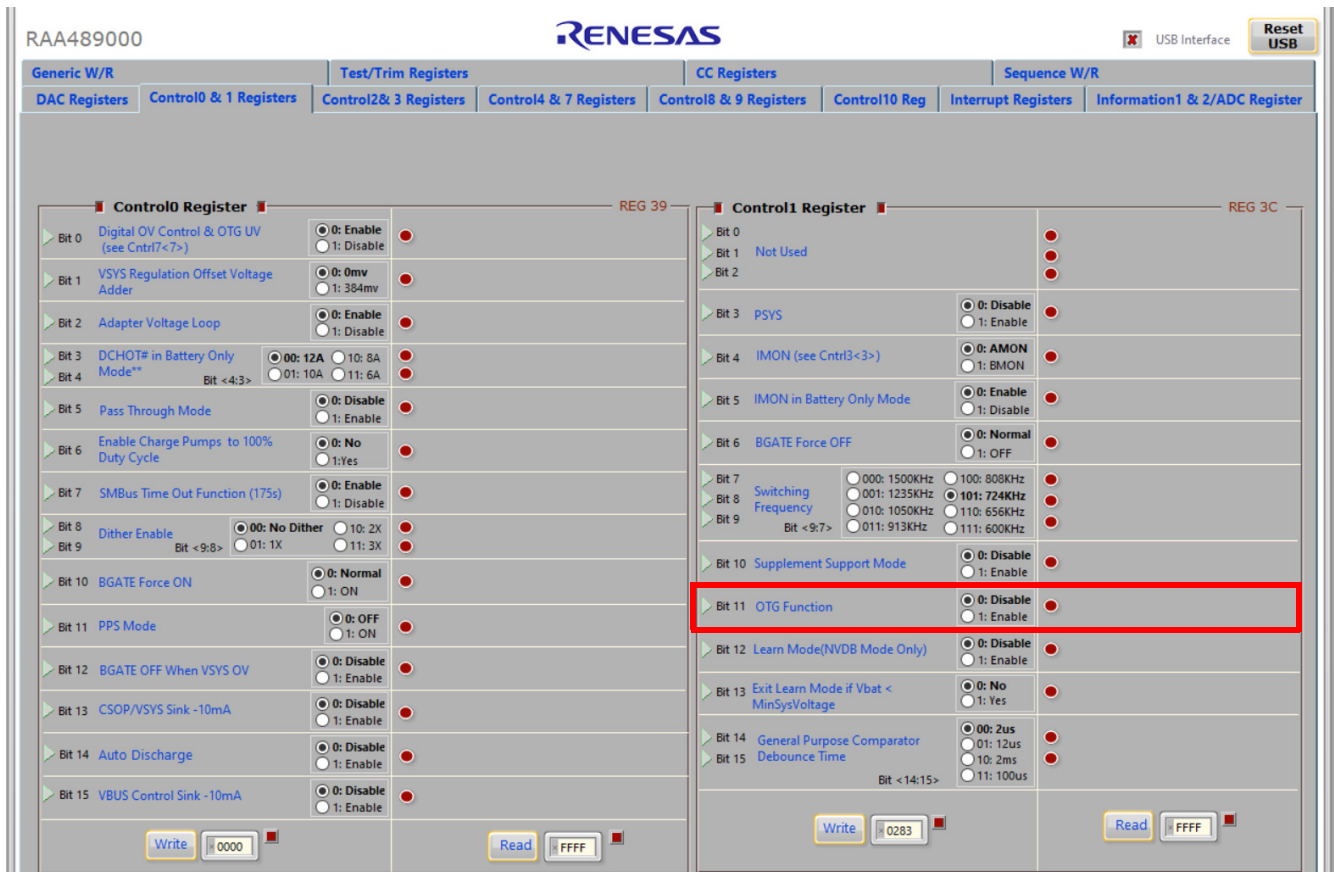

Figure 10. Enabling OTG Function

7. Switch SW2 on the evaluation board to the HI position. The load voltage is regulated as an **OTGVoltage** value, set in Step 4.
8. Increase the electrical load slowly and monitor the load voltage. If the load current is less than the **OTGCurrent** limit value, the load voltage is regulated at the setting value.

3.8 Configuring the RTKA489000DE0000BU as Source

1. Set the battery emulator voltage at a constant value between 5.8V and 15V. Connect battery leads J5A and J6A with the output disabled.
2. Connect an electric load on supply leads J1A and J2A with the output disabled.
3. Connect the USB cable at the USB port for SMBus. Turn on the battery emulator and electrical load without adding any load.
4. Open the RAA489000 GUI. Select the **Generic W/R** tab and set **Device ID** as 0x0044, see [Figure 11](#).

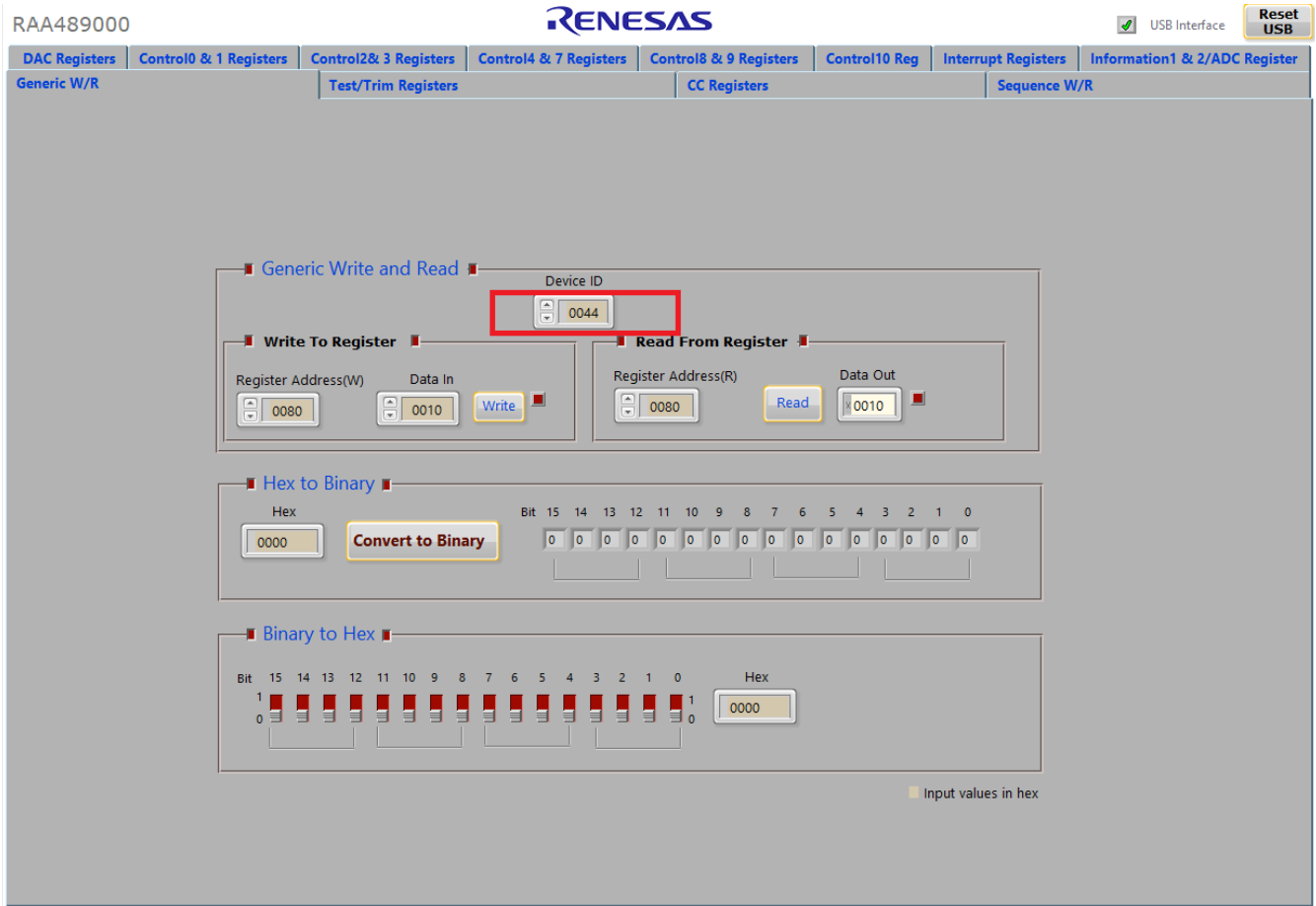

Figure 11. Configuring RAA489000 Through TCPC

5. In the **Write To Register** box, set **Register Address** to 0x0080 and **Data In** to 0x0010, then click **Write** to enable TCPC to control power. See [Figure 12](#).

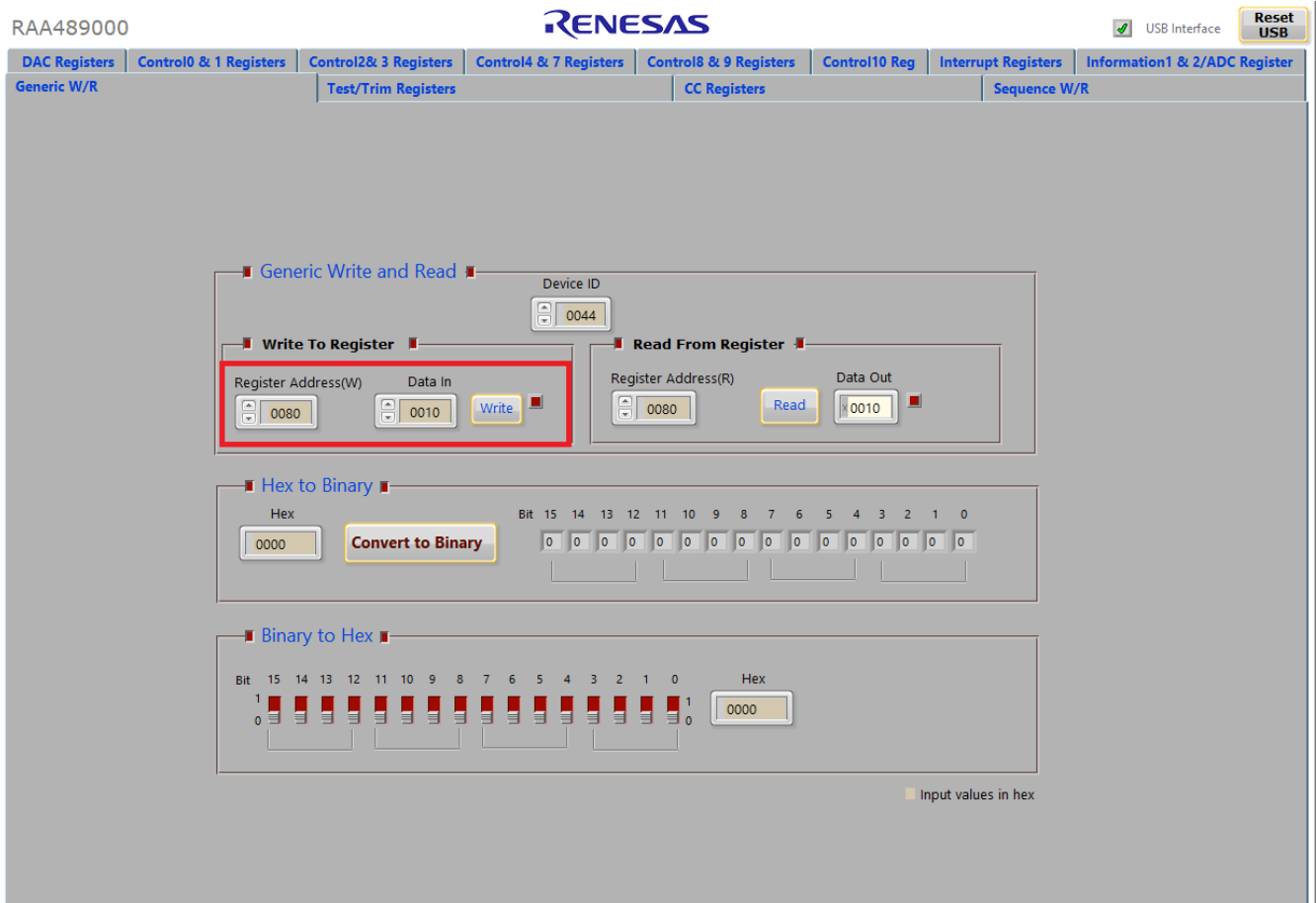

Figure 12. Enabling TCPC to Control Power

6. In the **Write To Register** box, set **Register Address** to 0x0090 and **Data In** to 0x0107, then click **Write** to set VBUS_5V_TARGET at 5.26V.
7. In the **Write To Register** box, set **Register Address** to 0x0092 and **Data In** to 0x0064, then click **Write** to set VBUS_CURRENT_TARGET at 3.2A.
8. In the **Write To Register** box, set **Register Address** to 0x0023 and **Data In** to 0x0077, then click **Write** to enable RTKA489000DE0000BU as source.
9. Increase the electrical load slowly and monitor the load voltage. If the load current is less than the current limit value, set in Step 7, the load voltage would be regulated at the voltage value, set in Step 6.

3.9 Configuring the RTKA489000DE0000BU as Sink

1. Complete Steps 1 and 2 in [Regulating System Voltage](#). Ensure the input current does not exceed the limit.
2. Turn on the power supply and measure VSYS using the DMM across (+) and (-). VSYS should read 8.38V.
3. Add an electrical load on VSYS and GND terminals J3A and J4A. Turn on the load and set the electrical load at 0.1A, measure VSYS using the DMM across (+) and (-). VSYS should still read 8.38V.
4. Open the RAA489000 GUI. Select the **Generic W/R** tab and set **Device ID** as 0x0044, see [Figure 11](#).
5. In the **Write To Register** box, set **Register Address** to 0x0080 and **Data In** to 0x0010, then click **Write** to enable TCPC to control power, see [Figure 12](#). Measure VSYS using the DMM across (+) and (-). VSYS should read 0 now.

In the **Write To Register** box, set **Register Address** to 0x0023 and Data In to 0x0055, then click **Write** to configure the RTKA489000DE0000BU as Sink. Measure VSYS using the DMM across (+) and (-). VSYS should read 8.38V.

4. Board Design

4.1 PCB Layout Guidelines

This section provides real examples of PCB layouts. The guidance is specific to board implementation, indicates key techniques used, and highlights areas that affect both functionality and performance.

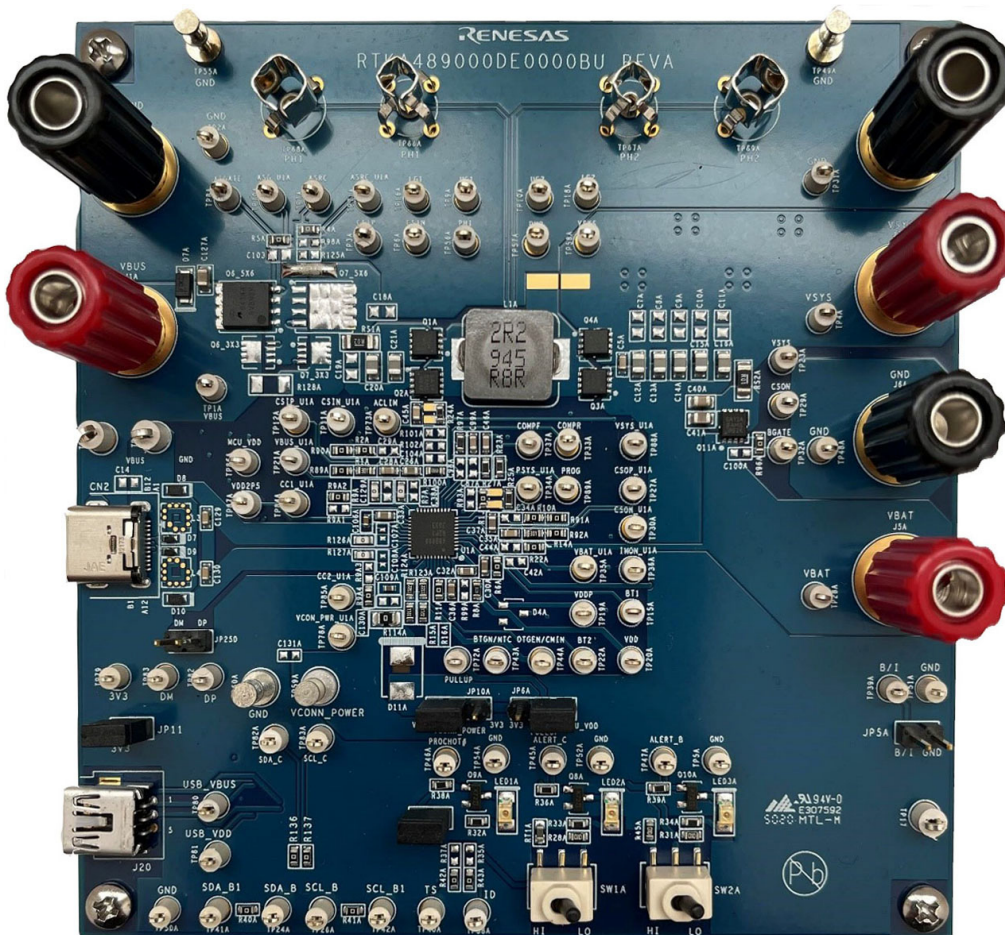

Figure 13. Evaluation Board (Top)



Figure 14. Evaluation Board (Bottom)

4.1.1 Guidelines for PCB Layout Guidelines

Pin #	Pin Name	Layout Guidelines
1	VDDP	Place the decoupling capacitor in the general proximity of the controller. Run the trace connecting to the VDDP pin with sufficient width.
2	LGATE1	Switching pin. Run the LGATE1 trace in parallel with the UGATE1 and PHASE1 traces on the same PCB layer. Use sufficient width. Avoid any sensitive analog signal trace from crossing over or getting close.
3	PHASE1	Run these two traces in parallel fashion with decent width. Avoid any sensitive analog signal trace from crossing over or getting close. Renesas recommends routing the PHASE1 trace to the high-side MOSFET source pin instead of general copper.
4	UGATE1	Place the IC close to the switching gate terminals of the MOSFET and keep the gate drive signal traces short for a clean MOSFET drive. The IC can be placed on the opposite side of the switching MOSFETs. Place the input capacitors as close as possible to the switching high-side MOSFET drain and the low-side MOSFET source and use shortest PCB trace connection. Place these capacitors on the same PCB layer as the MOSFETs. Do not place the capacitors on different layers with via connections. Place the inductor terminal to the switching high-side MOSFET drain and low-side MOSFET source terminal as close as possible. Minimize the phase node area to lower the electrical and magnetic field radiation but make the phase node area large enough to carry the current. Place the inductor and the switching MOSFETs on the same layer of the PCB.

Pin #	Pin Name	Layout Guidelines
5	BOOT1	Switching pin. Place the bootstrap capacitor in the general proximity of the controller. Use sufficiently wide traces. Avoid any sensitive analog signal trace from crossing over or getting close.
6	BGATE	Use a sufficiently wide trace from the IC to the BGATE N-type MOSFET gate. Place the capacitor from BGATE to ground close to the MOSFET.
7	VBAT	Place the optional RC filter in the general proximity of the controller. Run a dedicated trace from the battery positive connection point to the IC.
8	CSON	Run two dedicated traces with sufficient width in parallel (close to each other to minimize the loop area) from the two terminals of the battery current-sensing resistor to the IC. Place the differential mode and common-mode RC filter components in the general proximity of the controller.
9	CSOP	Route the current-sensing traces through vias to connect the center of the pads or route the traces into the pads from the inside of the current-sensing resistor. The following drawings show the two preferred ways of routing current-sensing traces. <div style="text-align: center;"> </div>
10	NC	Do not connect.
11	PROG	Signal pin. Place the PROG programming resistor in the general proximity of the controller.
12	COMPF	Place the compensation components in the general proximity of the controller. Avoid any switching signal from crossing over or getting close.
13	COMPR	
14	AMON/BMON	No special consideration. Place the optional RC filter in the general proximity of the controller.
15	ACLIM	Place the ACLIM resistor in the general proximity of the controller.
16	ASRC	Run this trace with sufficient width in parallel fashion with the ASGATE trace.
17	CSIN	Run two dedicated traces with sufficient width in parallel (close to each other to minimize the loop area) from the two terminals of the adapter current-sensing resistor to the IC. Place the Differential mode and common-mode RC filter components in the general proximity of the controller. Keep the CSIN node near the Q ₁ drain.
18	CSIP	Route the current-sensing traces through vias to connect the center of the pads or route the traces into the pads from the inside of the current-sensing resistor. The following drawings show the two preferred ways of routing current-sensing traces. <div style="text-align: center;"> </div>
19	ASGATE	Run this trace with sufficient width in parallel fashion with the ASRC trace.
20	VBUS	Run a dedicated trace from the bus to the pin and do not route near the switching traces.
21	VSYS	Run a dedicated trace from the system to the pin and do not route near the switching traces.
22	ALERT_B	Digital pin, open-drain output. No special consideration.
23	VDD	Place the RC filter connecting with VDD pin in the general proximity of the controller. Run the trace connecting to the VDD pin with sufficient width.
24	PROCHOT#	Digital pin, open-drain output. No special consideration.

Pin #	Pin Name	Layout Guidelines
25	MCU_VDD	Place the decoupling capacitor in the general proximity of the controller. Route the trace with sufficient width.
26	VDD2P5	
27	ALERT_C	Digital pin, open-drain output. No special consideration.
28	CC1	Route the trace with sufficient width. Place decoupling capacitor to filter the noise. Renesas recommends placing the charger CC pins as close to the USB connector as possible, avoid stubs on the CC lines, and route the CC lines with about the same length.
29	CC2	
30	BATGONE/NTC	Digital pin (BATGONE), Analog Pin (NTC). Place the 10kΩ resistor series in the BATGONE signal trace and the optional decoupling capacitor in the general proximity of the controller.
31	SCL_B	Digital pins. No special consideration. Run the SDA and SCL traces in parallel.
32	SDA_B	
33	VCONN_POWER	Place the decoupling capacitor in the general proximity of the controller. Route the trace with sufficient width.
34	SDA_C	Digital pins. No special consideration. Run the SDA and SCL traces in parallel.
35	SCL_C	
36	OTGEN/CMIN	Digital pins. No special consideration.
37	BOOT2	Switching pin. Place the bootstrap capacitor in the general proximity of the controller. Use sufficiently wide trace. Avoid any sensitive analog signal trace from crossing over or getting close.
38	UGATE2	Run these two traces in parallel fashion with sufficient width. Avoid any sensitive analog signal trace from crossing over or getting close. Renesas recommends routing the PHASE2 trace to the high-side MOSFET source pin instead of general copper. Place the IC close to the switching MOSFET's gate terminals and keep the gate drive signal traces short for a clean MOSFET drive. The IC can be placed on the opposite side of the switching MOSFETs. Place the output capacitors as close as possible to the switching high-side MOSFET drain and the low-side MOSFET source and use shortest PCB trace connection. Place these capacitors on the same PCB layer as the MOSFETs. Do not place the capacitors on different layers with via connections. Place the inductor terminal to the switching high-side MOSFET drain and low-side MOSFET source terminal as close as possible. Minimize this phase node area to lower the electrical and magnetic field radiation but make this phase node area large enough to carry the current. Place the inductor and the switching MOSFETs on the same layer of the PCB.
39	PHASE2	
40	LGATE2	Switching pin. Run the LGATE2 trace in parallel with the UGATE2 and PHASE2 traces on the same PCB layer. Use sufficient width. Avoid any sensitive analog signal trace from crossing over or getting close.
Bottom Pad	GND	Connect this ground pad to the ground plane through a low impedance path. Renesas recommends using at least five vias to connect to ground planes in the PCB to ensure sufficient thermal dissipation directly under the IC.

4.2 Schematics Drawings

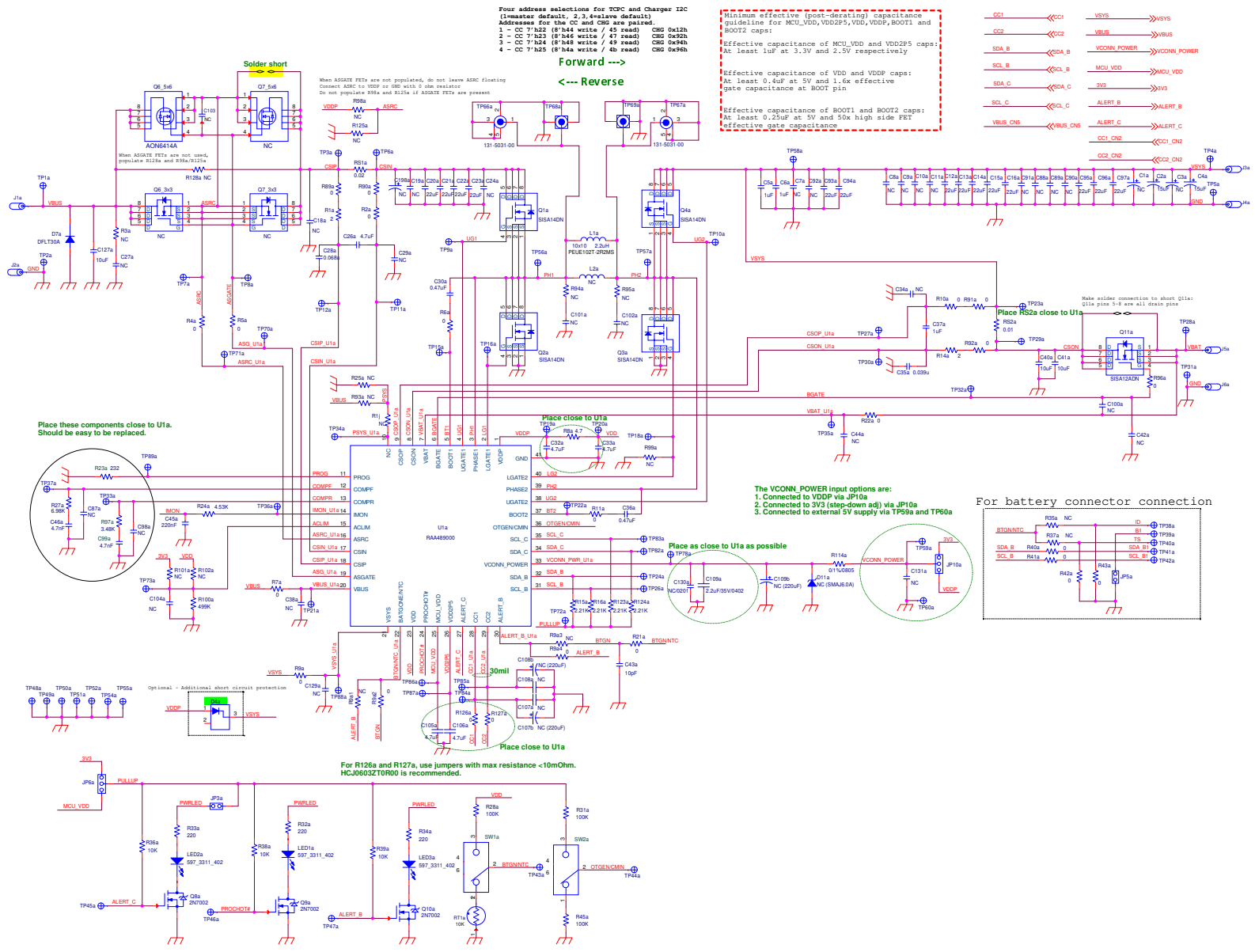
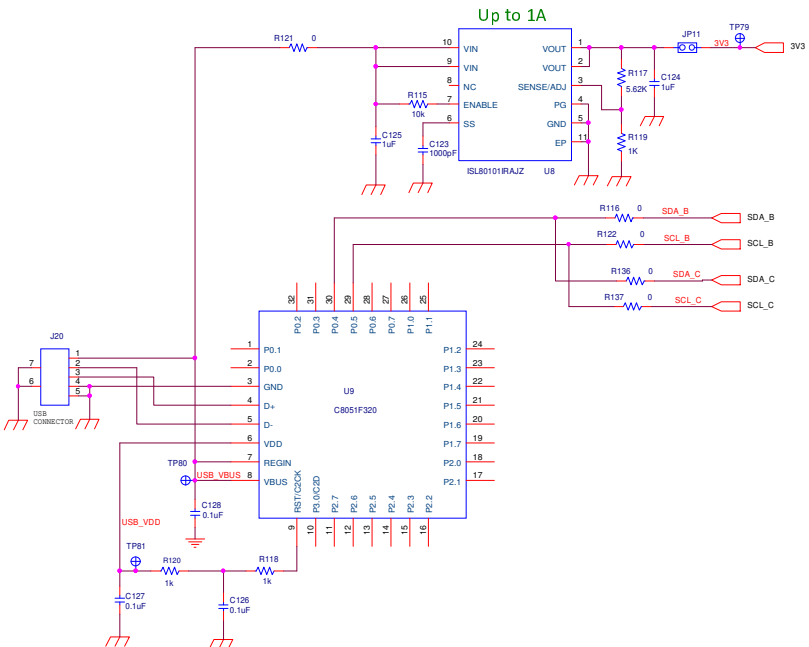

Figure 15. Schematic (1/2)



CC1	CC1	VSYS	VSYS
CC2	CC2	VBUS	VBUS
SDA_B	SDA_B	VCONN_POWER	VCONN_POWER
SCL_B	SCL_B	MCU_VDD	MCU_VDD
SDA_C	SDA_C	3V3	3V3
SCL_C	SCL_C	ALERT_B	ALERT_B
		ALERT_C	ALERT_C
		CC1_CN2	CC1_CN2
		CC2_CN2	CC2_CN2

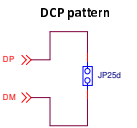
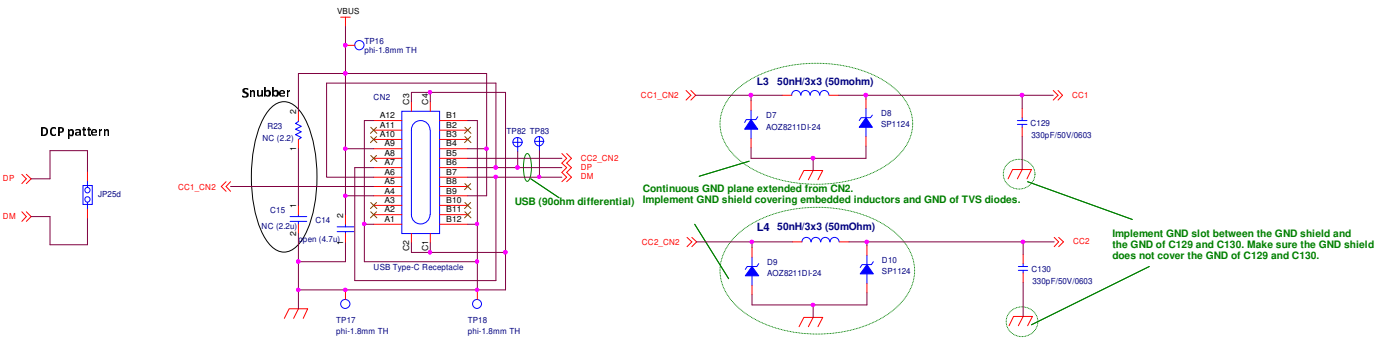

Figure 16. Schematic (2/2)

4.3 Bill of Materials

Qty	Reference Designator	Description	Manufacturer	Manufacturer Part Number
1		PWB-PCB, RTKA489000DE0000BU, ROHS	IMAGINEERING INC	RTKA489000DE0000BU
0		CAP-POSCAP, SMD, 3.5x2.8mm, 15µF, 25V, 20%, 100mΩ, ROHS	Panasonic	25TQC15MYFB
2	C105a, C106a	CAP CER 4.7µF 10V X5R 0402	Murata	GRM155R61A475MEAAD
1	C109a	CAP, SMD, 0402, 2.2µF, 35V, 10%, X5R, ROHS	TDK	C1005X5R1V225K050BC
1	C43a	CAP, SMD, 0603, 10pF, 50V, 10%, NP0, ROHS	Venkel	C0603COG500-100KDE
2	C129, C130	CAP, SMD, 0603, 330pF, 50V, 10%, X7R, ROHS	Yageo	CC0603KRX7R9BB331
1	C123	CAP, SMD, 0603, 1000pF, 16V, 10%, X7R, ROHS	Venkel	C0603X7R160102KNE
3	C126, C127, C128	CAP, SMD, 0603, 0.1µF, 25V, 10%, X7R, ROHS	Yageo	CC0603KRX7R8BB104
2	C5a, C6a	CAP, SMD, 0603, 1µF, 50V, 10%, X5R, ROHS	Murata	GRT188R61H105KE13D
3	C37a, C124, C125	CAP, SMD, 0603, 1µF, 25V, 10%, X5R, ROHS	Murata	GRM188R61E105KA12D
2	C46a, C99a	CAP, SMD, 0603, 4700pF, 50V, 10%, X7R, ROHS	TDK	CGA3E2X7R1H472K080AA
2	C30a, C36a	CAP, SMD, 0603, 0.22µF, 25V, 10%, X7R, ROHS	TDK	C1608X7R1E224K
1	C28a	CAP, SMD, 0603, 0.068µF, 25V, 10%, X7R, ROHS	Murata	GRM188R71E683KA01D
1	C35a	CAP, SMD, 0603, 0.039µF, 25V, 10%, X7R, ROHS	Murata	GRM188R71E393KA01D
1	C45a	CAP, SMD, 0603, 220nF, 50V, 10%, X7R, ROHS	Yageo	CC0603KRX7R9BB224
3	C26a, C32a, C33a	CAP, SMD, 0603, 4.7µF, 10V, 10%, X5R, ROHS	Venkel	C0603X5R100-475KNE
3	C40a, C41a, C127a	CAP, SMD, 0805, 10µF, 25V, 10%, X5R, ROHS	TDK	C2012X5R1E106K
14	C20a, C21a, C22a, C23a C12a-C16a, C93a-C97a	CAP, SMD, 0805, 22µF, 25V, 20%, X5R, ROHS	TDK	C2012X5R1E226M125AC
1	L1a	PWR CHOKE COIL, SMD, 10x10x2, 2.2µH, 10A, 20%, 14mΩ, ROHS	Cyntec CO.,LTD.	PEUE102T-2R2MS
1	CN2	USB Type-C Receptacle		DX07S024JJ2

3	J1a, J3a, J5a	CONN-GEN, BIND.POST, INSUL-RED, THMBNUT- GND	Johnson Components	111-0702-001
3	J2a, J4a, J6a	CONN-GEN, BIND.POST, INSUL-BLK, THMBNUT- GND	Johnson Components	111-0703-001
2	TP68a, TP69a	CONN-SCOPE PROBE TEST PT, COMPACT, PCB MNT, ROHS	Tektronix	131-4353-00
2	TP66a, TP67a,	CONN-SCOPE PROBE TEST PT, COMPACT, PCB MNT, ROHS	Tektronix	131-5031-00
2	TP59a, TP60a	CONN-TURRET, TERMINAL POST, TH, ROHS	Keystone	1514-2
71	TP1A, TP2A, TP3A, TP4A, TP5A, TP6A, TP7A, TP8A, TP9A, TP10A, TP11A, TP12A, TP15A, TP16A, TP18A, TP19A, TP20A, TP21A, TP22A, TP23A, TP24A, TP26A, TP27A, TP28A, TP29A, TP30A, TP31A, TP32A, TP33A, TP34A, TP35A, TP36A, TP37A, TP38A, TP39A, TP40A, TP41A, TP42A, TP43A, TP44A, TP45A, TP46A, TP47A, TP48A, TP49A, TP50A, TP51A, TP52A, TP54A, TP55A, TP56A, TP57A, TP58A, TP70A, TP71A, TP72A, TP73A, TP78A, TP82A, TP83A, TP84A, TP85A, TP86A, TP87A, TP88A, TP89A, TP79, TP80, TP81, TP82, TP83	CONN-MINI TEST POINT, VERTICAL, WHITE, ROHS	Keystone	5002
3	TP16, TP17, TP18,	CONN-MINI TEST POINT, VERTICAL, WHITE, ROHS	Keystone	5007
1	J20	CONN-USB MINI-B RECEPTACLE, TH, 5CIRCUIT, R/A, ROHS	Molex	54819-0519
2	JP6a, JP10a	CONN-HEADER, 1x3, BREAKAWY 1x36, 2.54mm, ROHS	Berg/FCI	68000-236HLF
4	JP3a, JP5a, JP25d, JP11,	CONN-HEADER, 1x2, RETENTIVE, 2.54mm, 0.230X 0.120, ROHS	Berg/FCI	69190-202HLF
4	JP3a, JP11, JP6a-Pins 1(3V3)-2(PULLUP), JP10a-Pins 2(VCONN_POWER)- 3(VDDP).	CONN-JUMPER, SHORTING, 2PIN, BLACK, GOLD, ROHS	Sullins	SPC02SYAN

1	D7a	225W SURFACE MOUNT TRANSIENT VOLTAGE SUPPRESSOR		DFLT30A
2	D7, D9	TVS DIODE 24V 2DFN/0402C/SOD923F	Comchip Technology	CPDQC24VEU-HF
2	D8, D10	ESD Suppressors / TVS Diodes 30kV 24V 20A TVS Diod uDFN-2	Littelfuse	SP1124-01UTG
3	LED1a, LED2a, LED3a	LED, SMD, 1206, GREEN, 75mW, 3mcd, 567nm, ROHS	Dialight	597-3311-407NF
1	U9	IC-USB MICROCONTROLLER, 32P, LQFP, PROGRAMMED, ROHS	Silicon Laboratories	C8051F320-GQ
1	U8	IC-ADJ.V, 1A LDO REGULATOR, 10P, DFN, 3X3, ROHS	Intersil	ISL80101IRAJZ
1	U1a	IC-NOTEBOOK BATTERY CHARGER, 40P, TQFN, 5X5, ROHS	Renesas Electronics America	RAA489000*
3	Q8a, Q9a, Q10a	TRANSISTOR, N-CHANNEL, 3LD, SOT-23, 60V, 115mA, ROHS	Diodes, INC.	2N7002-7-F
1	Q11a	TRANSISTOR-MOS, N-CHANNEL, SMD, PWRPK 1212-8, 30V, 25A, ROHS	Vishay	SISA12ADN-T1-GE3
4	Q1a, Q2a, Q3a, Q4a	TRANSISTOR-MOS, N-CHANNEL, 8P, PWRPAK, 30V, 20A, ROHS	Vishay	SISA14DN-T1-GE3
2	Q6_5x6	TRANSISTOR-MOS, N-CHANNEL, 30V, 30A, 8P, DFN, 5x6, ROHS	Alpha & Omega Semiconductor	AON6414A
2	R1a, R14a	RES, SMD, 0603, 2Ω, 1/10W, 1%, TF, ROHS	Yageo	9C06031A2R00FGHFT
1	R8a	RES, SMD, 0603, 4.7Ω, 1/10W, 1%, TF, ROHS	Venkel	CR0603-10W-4R70FT
4	R7a, R9a, R126a, R127a	RES 0 Ω JUMPER 1/4W 0603	Stackpole Electronics Inc.	HCJ0603ZT0R00
24	R2a, R4a, R5a, R6a, R10a, R11a, R21a, R22a, R40a, R41a, R42a, R43a, R89a, R90a, R91a, R92a, R121, R116, R122, R96a, R9a2, R9a4, R136, R137	RES, SMD, 0603, 0Ω, 1/10W, TF, ROHS	Venkel	CR0603-10W-000T
3	R118, R119, R120	RES, SMD, 0603, 1k, 1/10W, 1%, TF, ROHS	Panasonic	ERJ-3EKF1001V
1	R23a	RES, SMD, 0603, 232, 1/10W, 1%, TF, ROHS	Vishay/Dale	CRCW0603232RFKEAC

4	R15a, R16a, R123a, R124a	RES, SMD, 0603, 2.21k, 1/10W, 1%, TF, ROHS	Vishay/Dale	CRCW06032K21FKEAC
1	R97a	RES, SMD, 0603, 3.48k, 1/10W, 1%, TF, ROHS	Panasonic	ERJ-3EKF3481V
1	R24a	RES, SMD, 0603, 4.53k, 1/10W, 1%, TF, ROHS	Panasonic	ERJ-3EKF4531V
1	R27a	RES, SMD, 0603, 6.98k, 1/10W, 1%, TF, ROHS	Panasonic	ERJ-3EKF6981V
4	R36a, R38a, R39a, R115	RES, SMD, 0603, 10k, 1/10W, 1%, TF, ROHS	Venkel	CR0603-10W-1002FT
1	R100a	RES, SMD, 0603, 121k, 1/10W, 1%, TF, ROHS	Vishay/Dale	CRCW0603121KFKEAC
3	R28a, R31a, R45a	RES, SMD, 0603, 100k, 1/10W, 1%, TF, ROHS	Venkel	CR0603-10W-1003FT
1	R25a	Do not populate		
3	R32a, R33a, R34a	RES, SMD, 0603, 220Ω, 1/10W, 1%, TF, ROHS	Yageo	RC0603FR-07220RL
1	R117	RES, SMD, 0603, 5.62k, 1/10W, 1%, TF, ROHS	Panasonic	ERJ-3EKF5621V
1	R114a	RES, SMD, 0805, 0Ω, 1/10W, TF, ROHS	Vishay/Dale	CRCW08050000Z0EA
1	RT1a	THERMISTOR-NTC, SMD, 0603, 10k, 1%, - 40+125C, ROHS	Murata	NCP18XH103F03RB
2	RS2a, RS1a	RES-CURR.SENSE, SMD, 1206, 0.01Ω, 1W, 1%, 75ppm, ROHS	Vishay/Dale	WSLP1206R0100FEA
0		RES-CURR.SENSE, SMD, 1206, 0.02Ω, 1W, 1%, 75ppm, ROHS	Vishay/Dale	WSLP1206R0200FEA
1	Solder short at Q7 (See it in the other attachment)	CONN-JUMPER, SOLDER SHORT,		
2	SW1a, SW2a	SWITCH-TOGGLE, SMD, 6PIN, SPDT, 2POS, ON-NONE-ON, ROHS	ITT Industries/C&K Division	GT11MSCBE
4	Four corners	SCREW, 4-40x1/4in, PHILLIPS, PANHEAD, STAINLESS, ROHS	Building Fasteners	PMSSS 440 0025 PH
4	Four corners	STANDOFF, 4-40x3/4in, F/F, HEX, ALUMINUM, 0.25 OD, ROHS	Keystone	2204
0	D4a	Do Not Populate or Purchase		
0	D11a	Do Not Populate or Purchase		
0	L2a	Do Not Populate or Purchase		
0	L3, L4	Do Not Populate or Purchase		

0	Q6_3x3, Q7_3x3	Do Not Populate or Purchase		
0	C107b, C108b, C109b, C198a	Do Not Populate or Purchase		
0	C7a-C11a, C19a, C24a, C88a-C92a	Do Not Populate or Purchase		
0	C27a, C18a, C29a, C34a	Do Not Populate or Purchase		
0	R3a, R35a, R37a, R98a, R101a, R102a, R125a	Do Not Populate or Purchase		
0	C42a, C44a, C87a, C98a, C100a, C101a, C102a, C104a, C131a, C103	Do Not Populate or Purchase		
0	C38a, C129a	Do Not Populate or Purchase		
0	C107a, C108a	Do Not Populate or Purchase		
0	C130a	Do Not Populate or Purchase		
0	C15	Do Not Populate or Purchase		
0	C14	Do Not Populate or Purchase		
0	R94a, R95a	Do Not Populate or Purchase		
0	R128a	Do Not Populate or Purchase		
0	R23	Do Not Populate or Purchase		
0	C1a, C3a, C2a, C4a	Do Not Populate or Purchase		
0	R93A, R9A1, R9a3	Do Not Populate or Purchase		
0	Q7_5x6	Do Not Populate or Purchase		

4.4 Board Layout

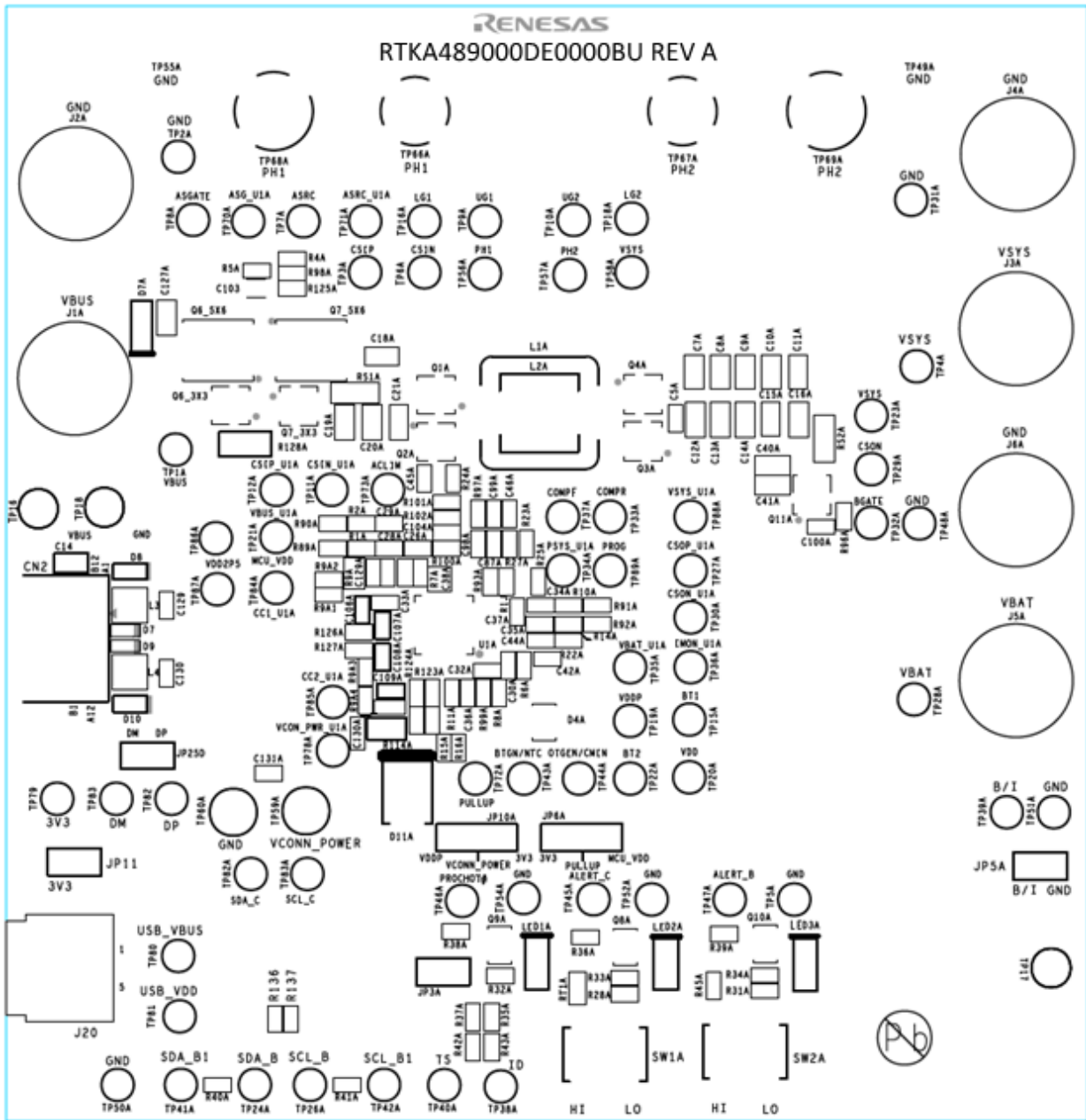

Figure 17. Top Silkscreen

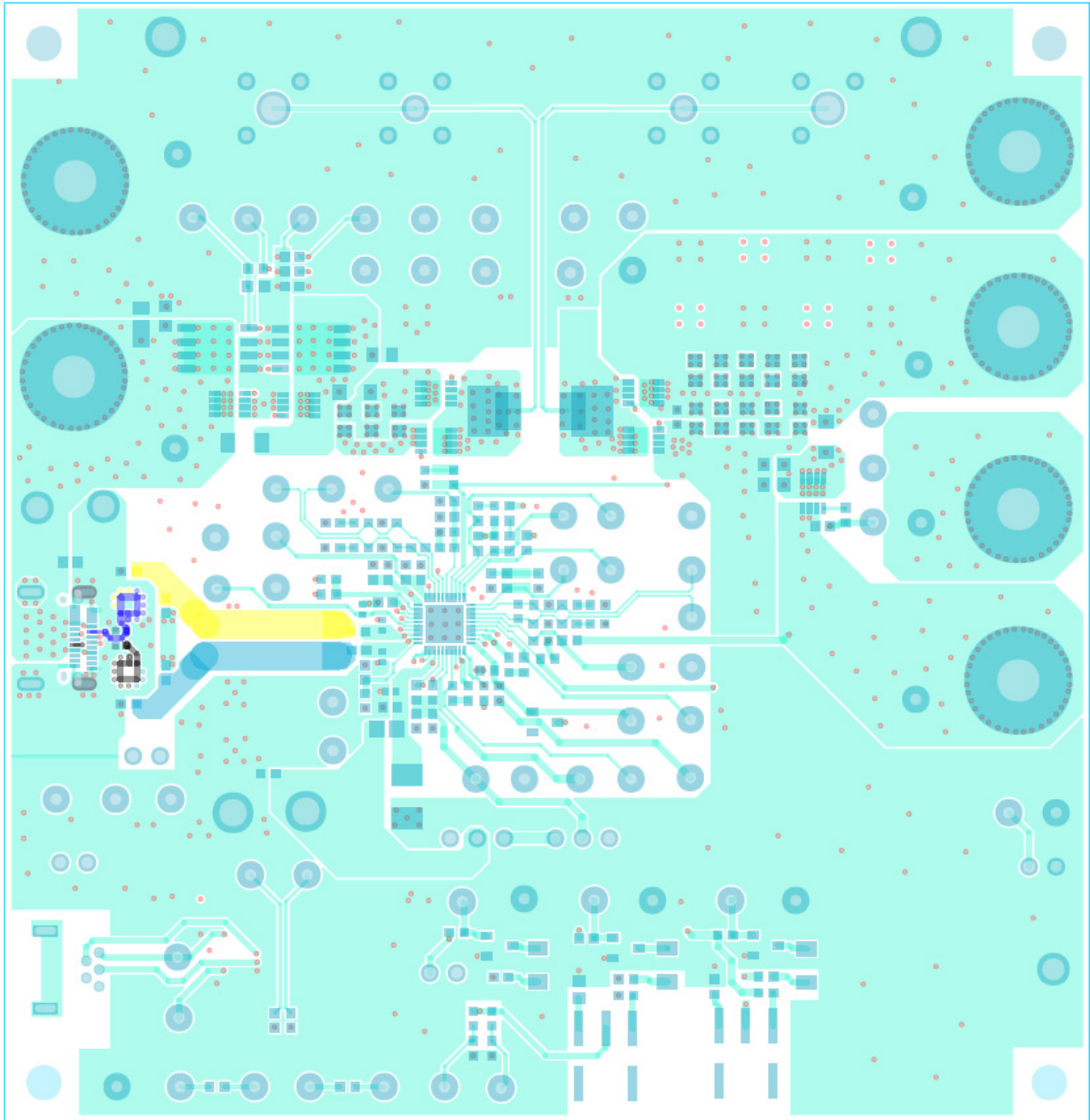

Figure 18. Top Layer

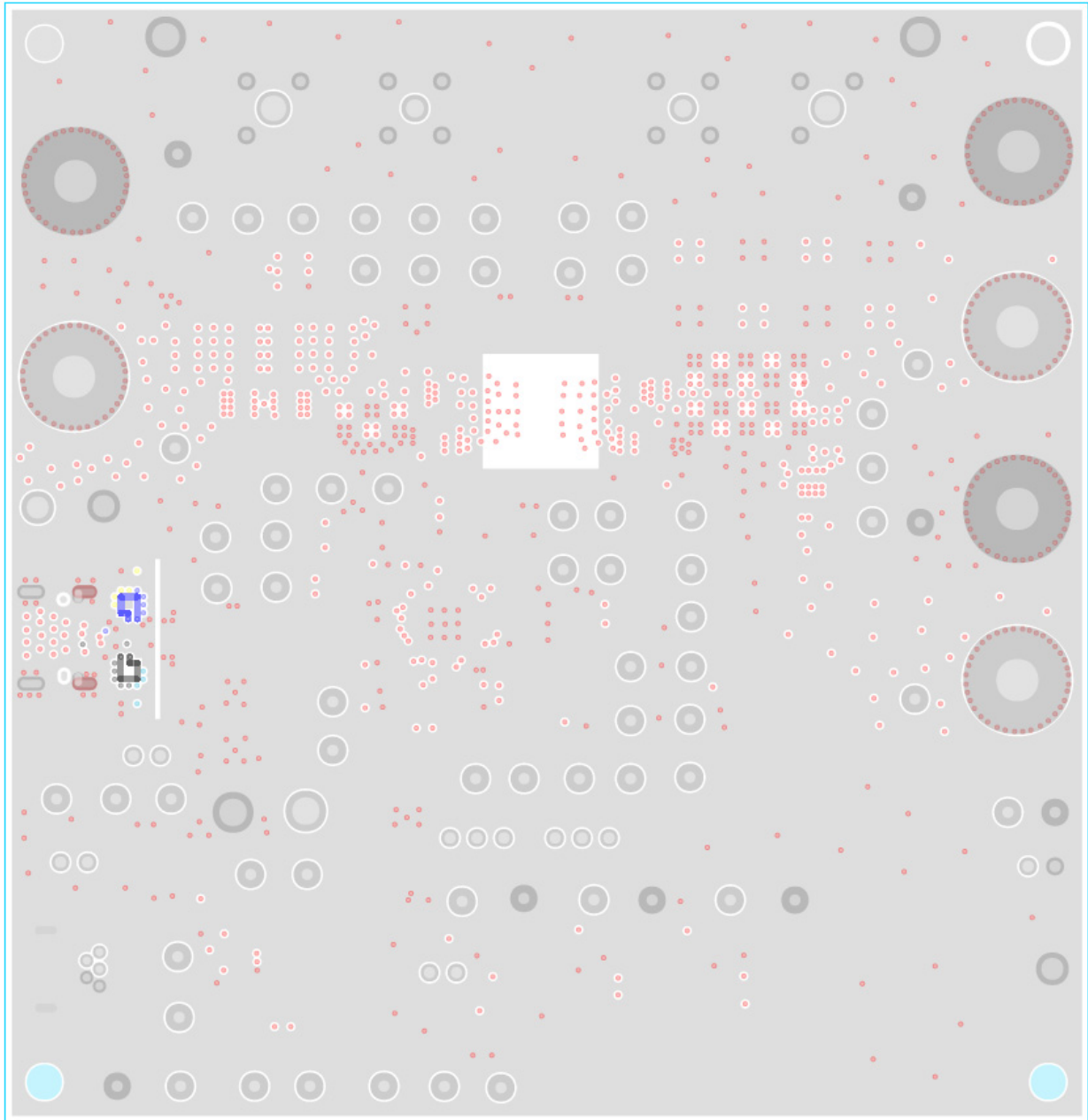

Figure 19. Layer 2

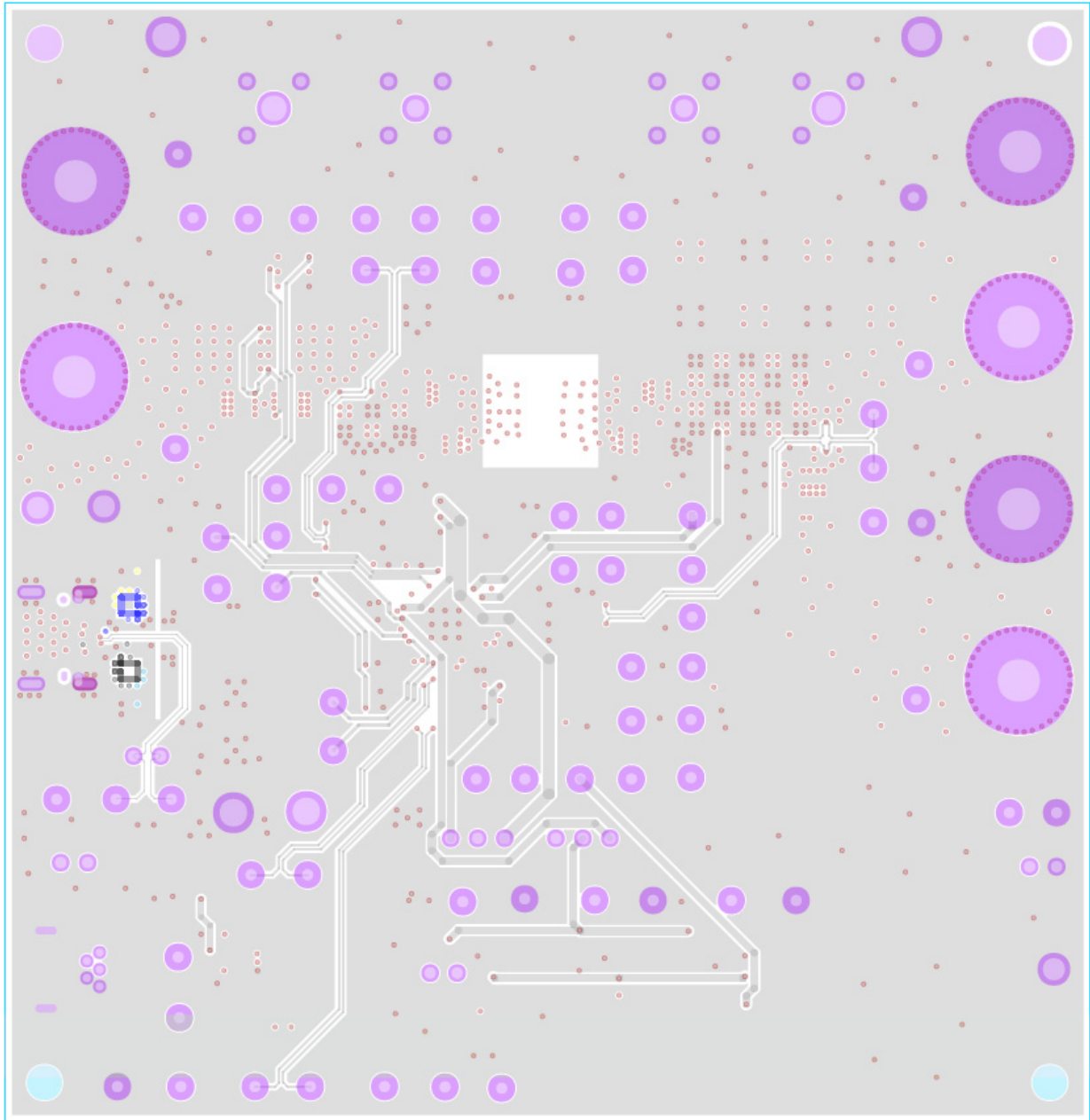

Figure 20. Layer 3

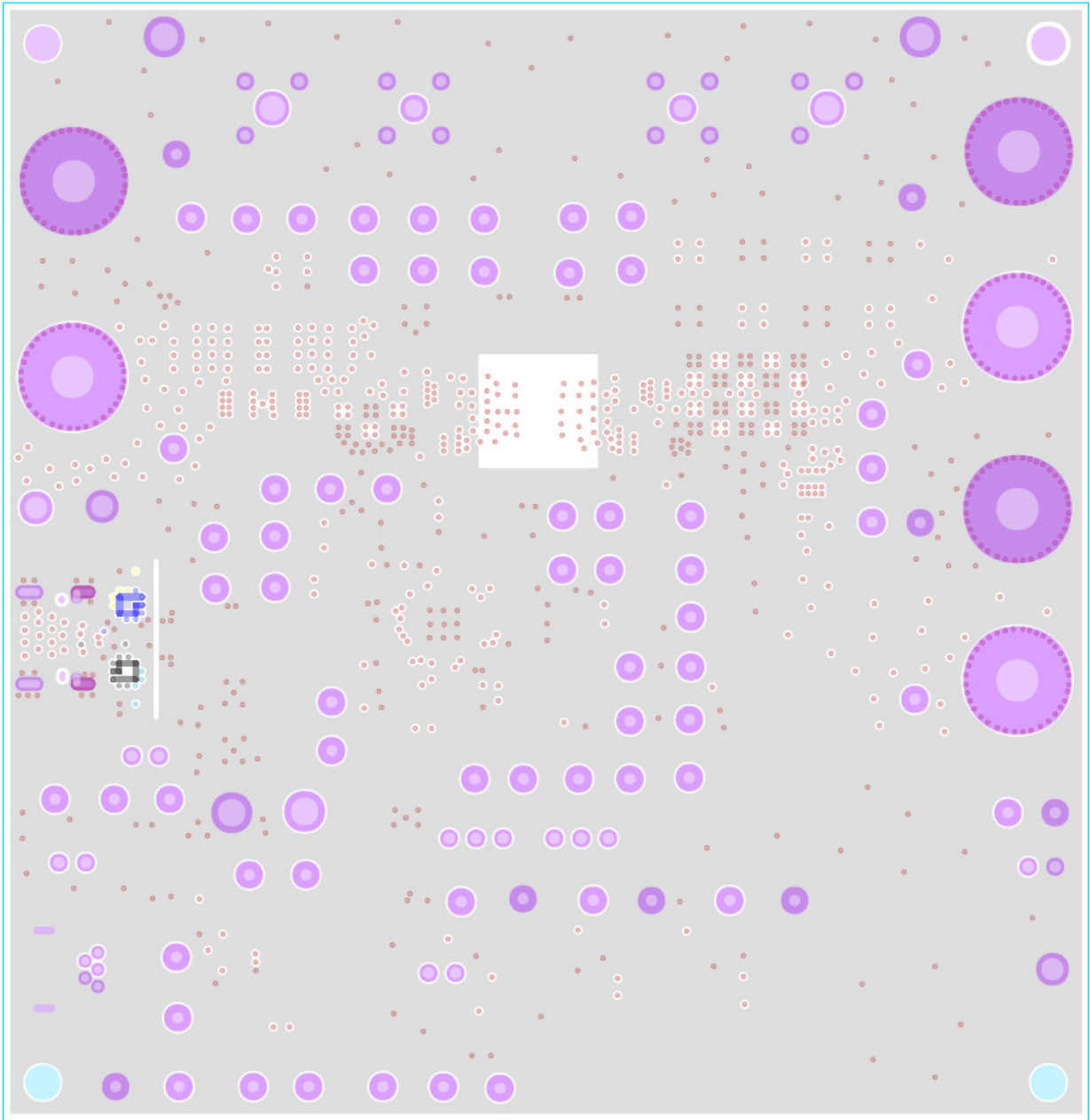

Figure 21. Layer 4

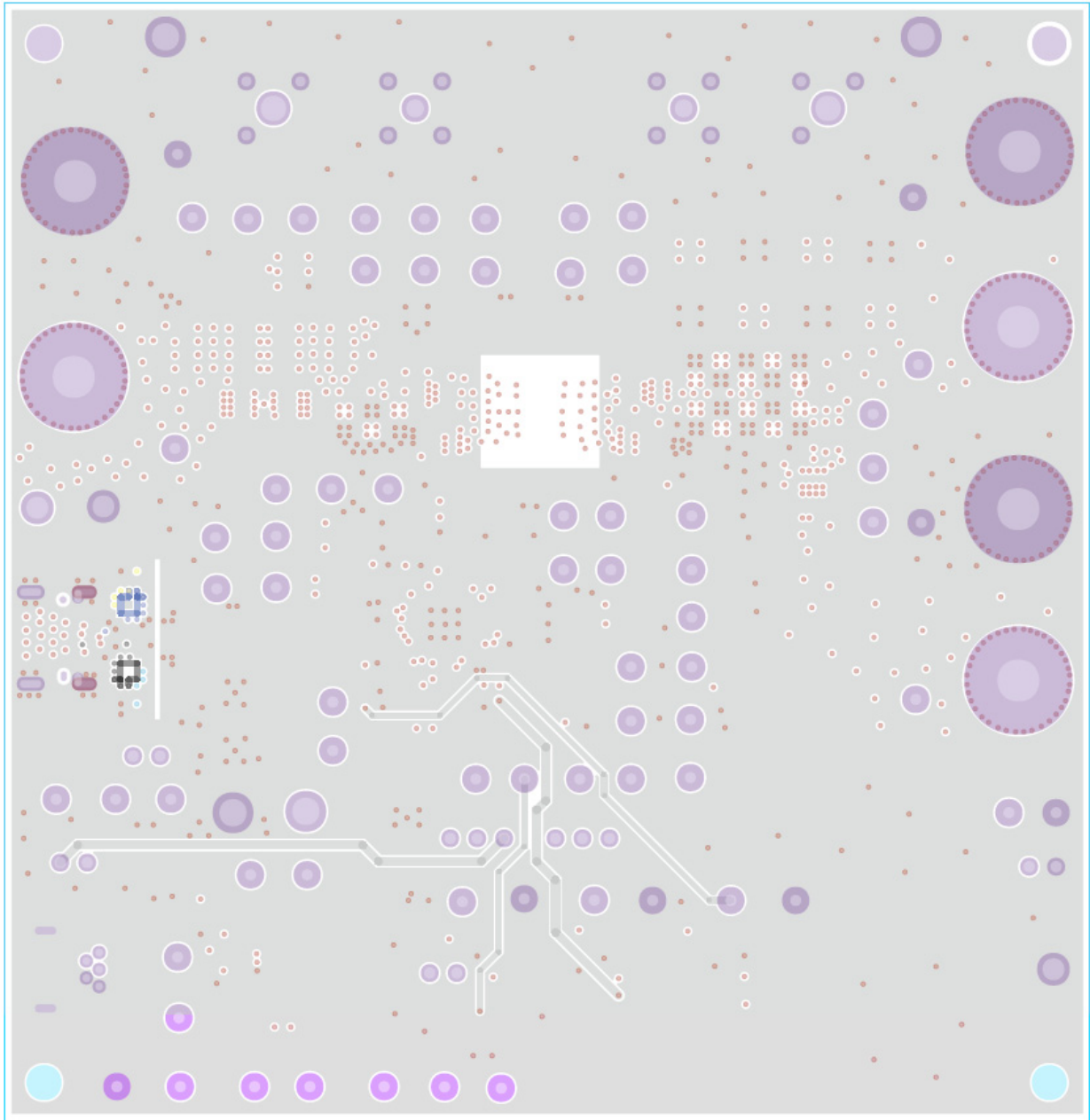

Figure 22. Layer 5

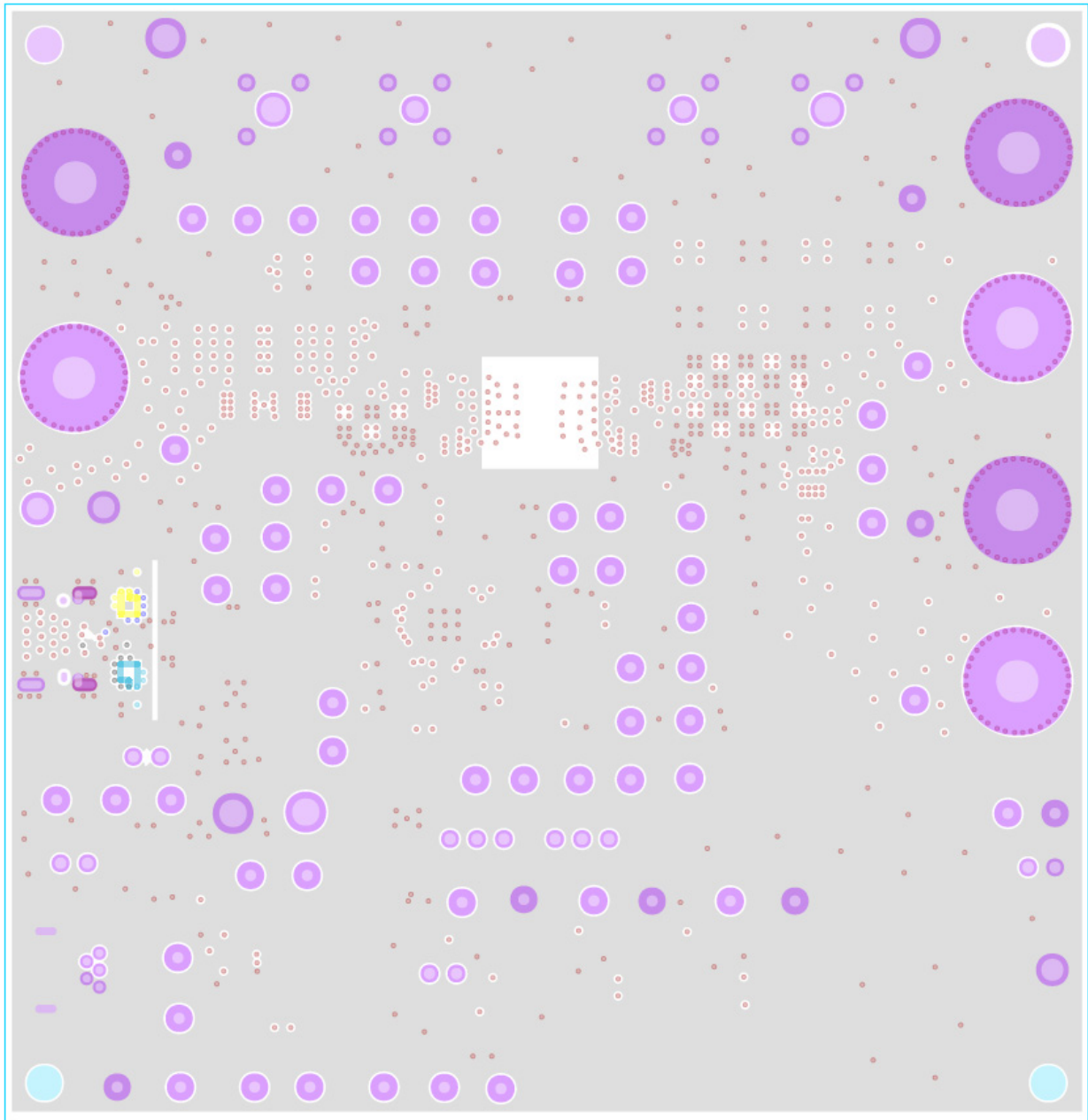

Figure 23. Layer 6

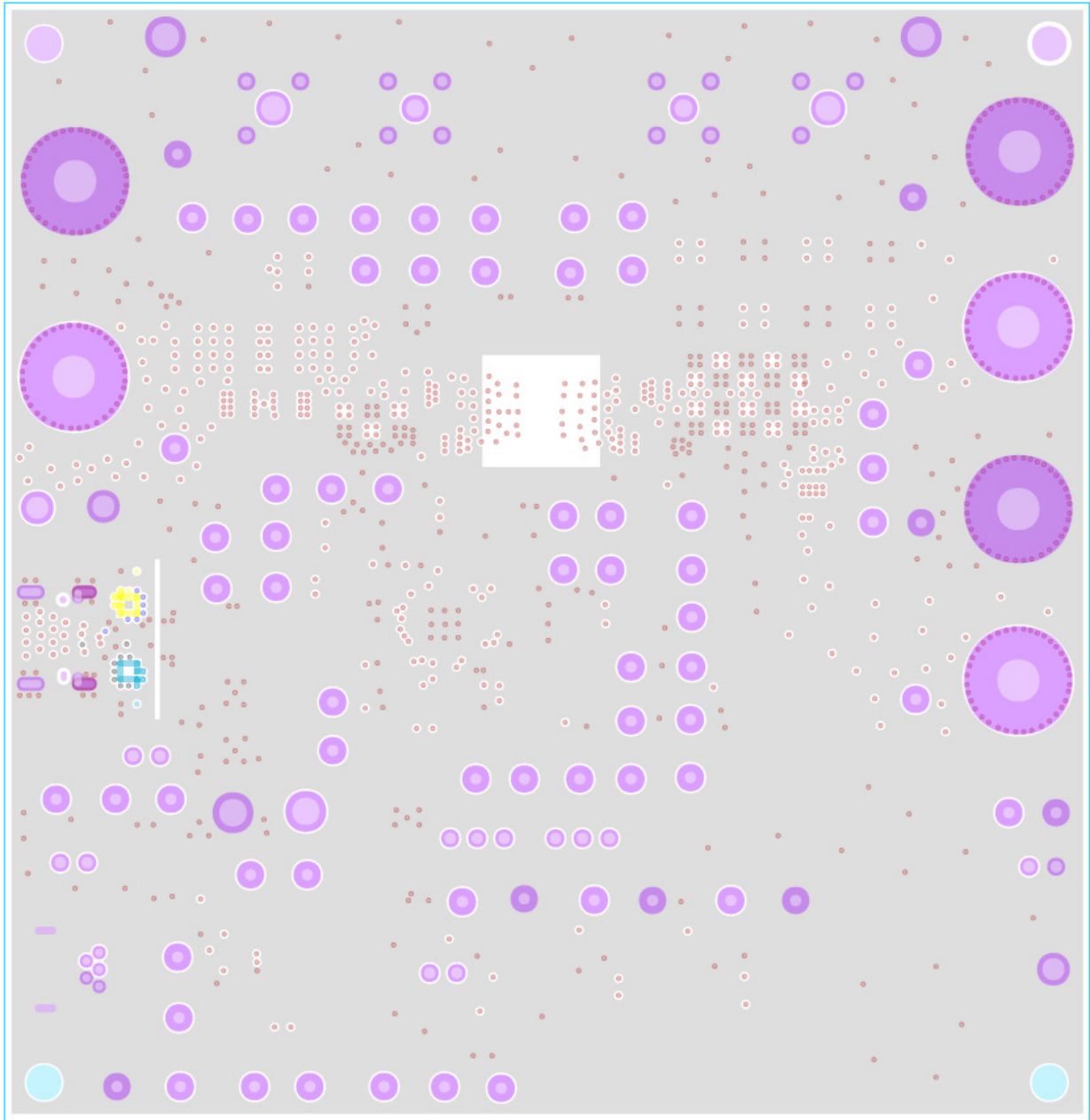

Figure 24. Layer 7

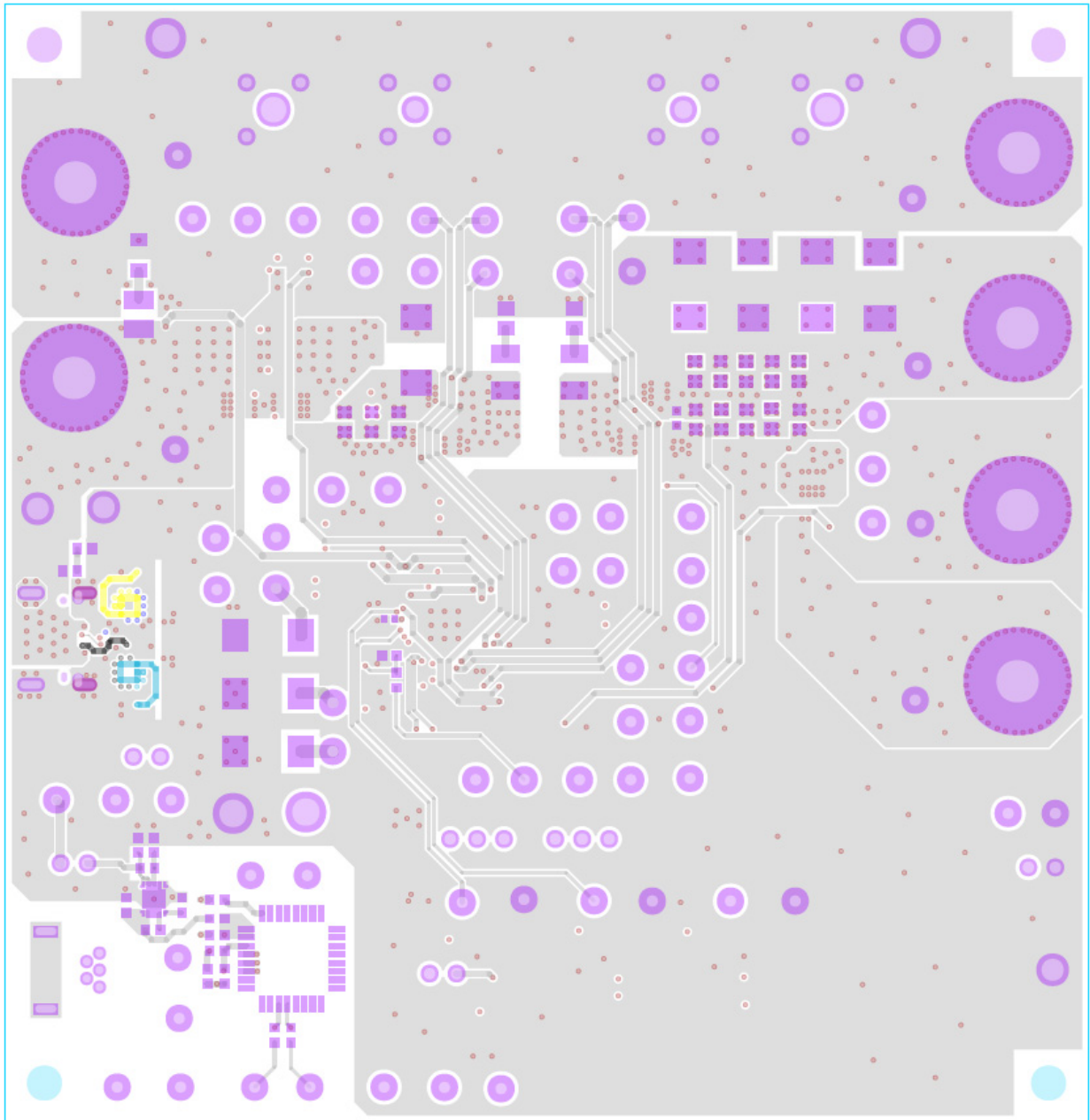

Figure 25. Bottom Layer

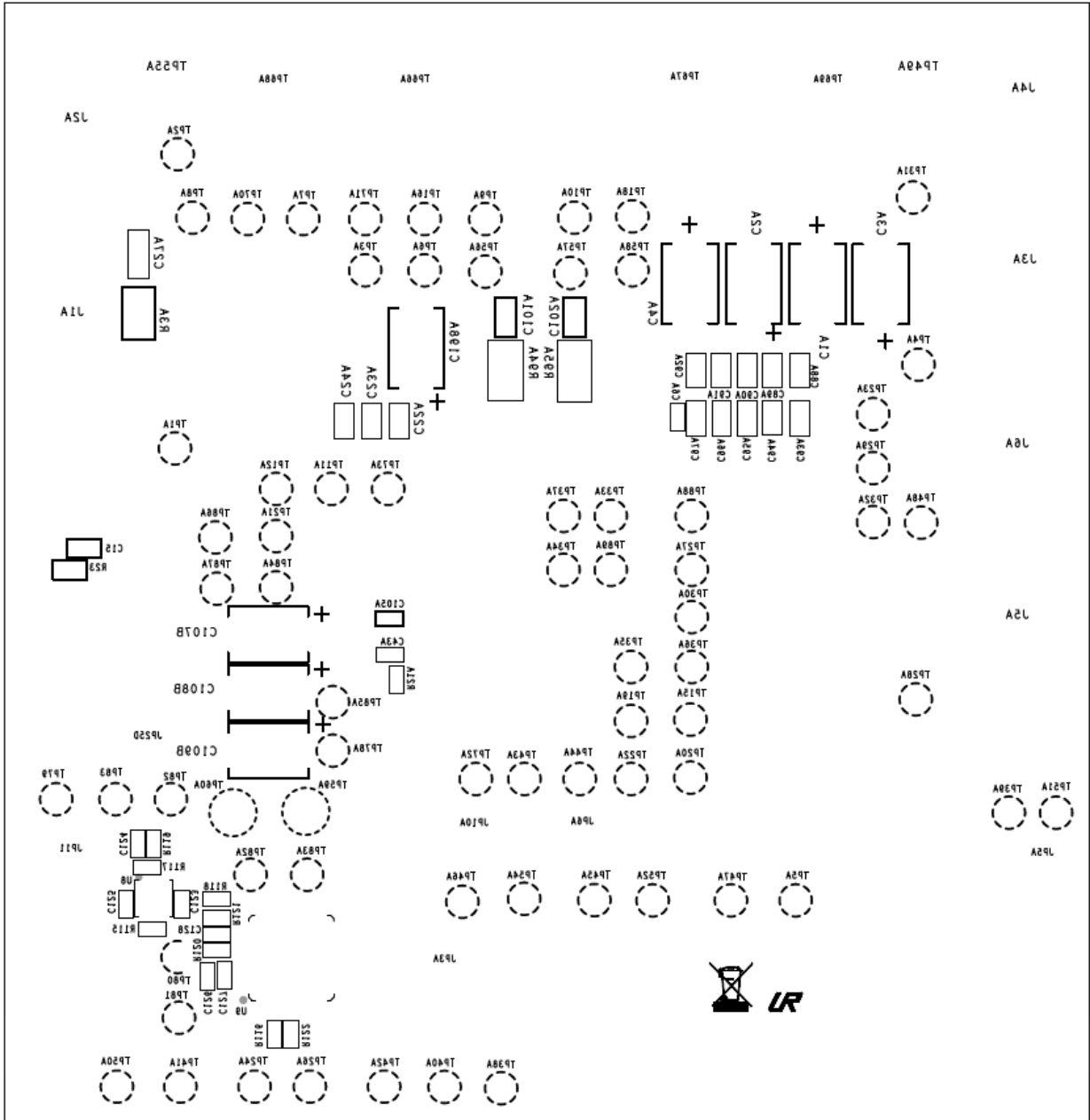

Figure 26. Bottom Silkscreen

5. Typical Performance

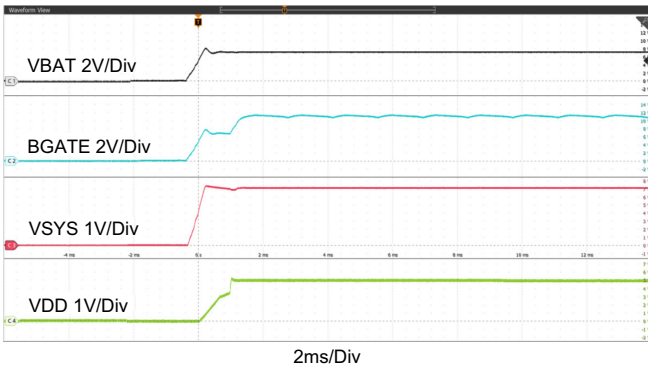

Figure 27. Start Up with Battery

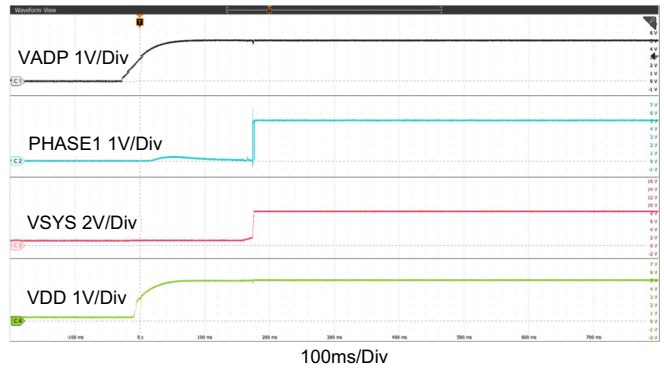

Figure 28. Start Up with 5V Adapter

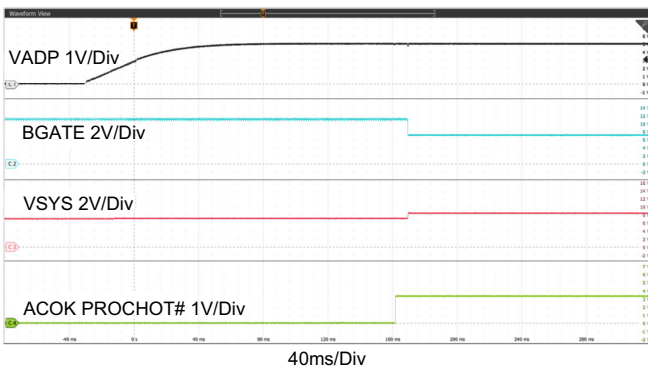

Figure 29. Start Up with Adapter and Battery,
 $V_{ADP} = 5V$, $MaxSystemVoltage = 8.384V$, $V_{BAT} = 7V$,
 Charge Current Limit = 0A

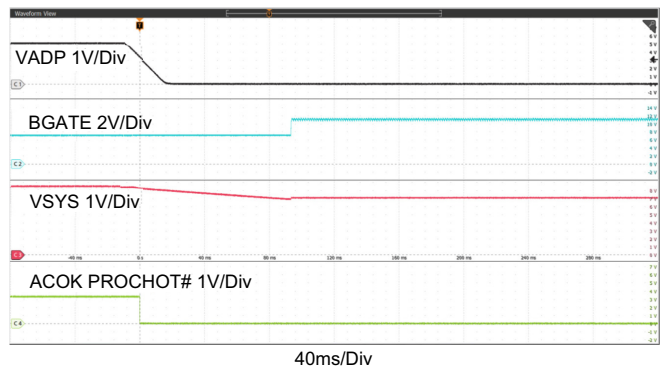

Figure 30. Adapter Removal,
 $V_{ADP} = 5V$, $MaxSystemVoltage = 8.384V$, $V_{BAT} = 7V$,
 Charge Current Limit = 0A, System Load = 0A

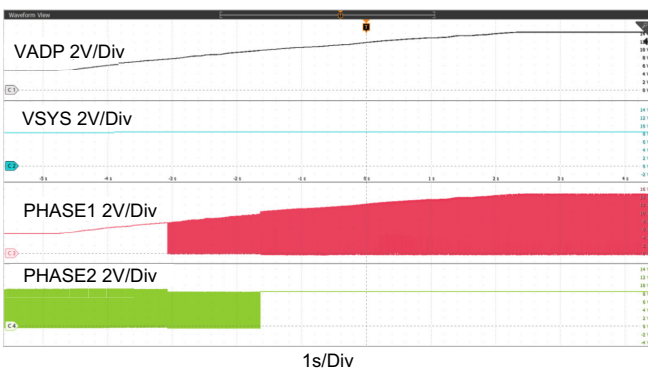

Figure 31. Adapter Voltage Ramp Up,
 Boost --> Buck_Boost -->
 Buck Operation Mode Transition

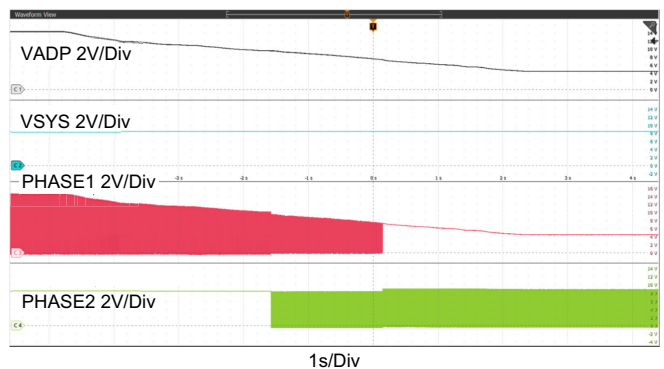

Figure 32. Adapter Voltage Ramp Down,
 Buck --> Buck_Boost -->
 Boost Operation Mode Transition

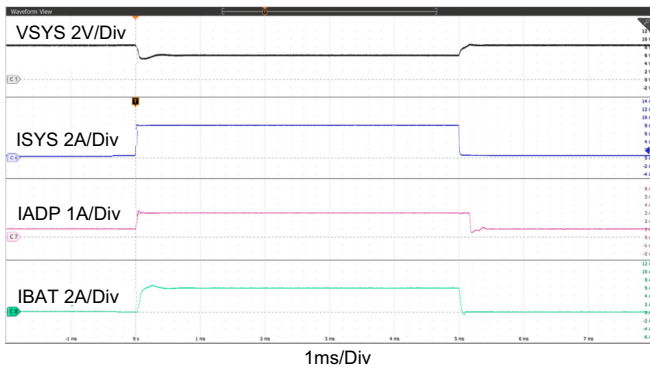

Figure 33. Boost Mode, Output Voltage Loop to Adapter Current Loop Transition, $V_{ADP} = 5V$, $V_{BAT} = 7V$, $MaxSystemVoltage = 8.384V$, $Adapter_current_limit = 3A$, $Charge_current = 0A$, $System_load = 0.5A$ to $8A$

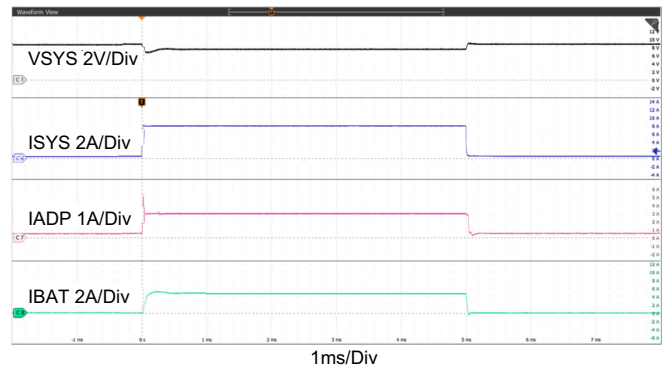

Figure 34. Boost Mode, Charge Current Loop to Adapter Current Loop Transition, $V_{ADP} = 5V$, $V_{BAT} = 7V$, $MaxSystemVoltage = 8.384V$, $Adapter_current_limit = 3A$, $Charge_current = 0.5A$, $System_load = 0.5A$ to $8A$

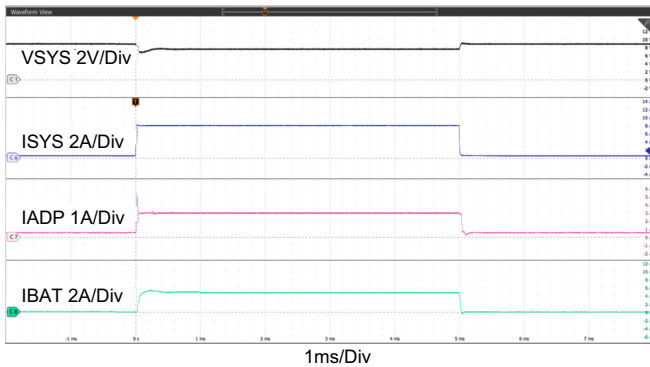

Figure 35. Buck_Boost Mode, Output Voltage Loop to Adapter Current Loop Transition, $V_{ADP} = 9V$, $V_{BAT} = 8.4V$, $MaxSystemVoltage = 8.8V$, $Adapter_current_limit = 3A$, $Charge_current = 0A$, $System_load = 0.5A$ to $8A$

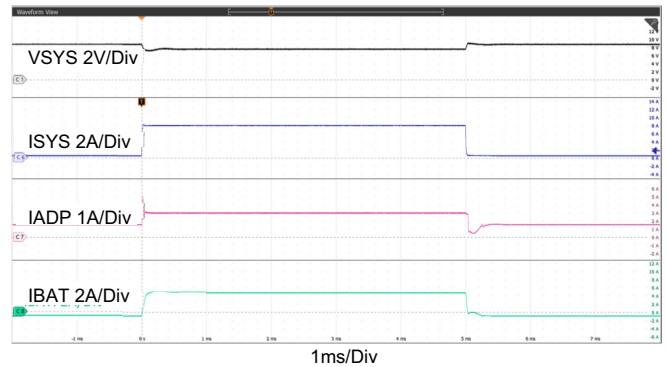

Figure 36. Buck_Boost Mode, Charge Current Loop to Adapter Current Loop Transition, $V_{ADP} = 9V$, $V_{BAT} = 8.4V$, $MaxSystemVoltage = 8.8V$, $Adapter_current_limit = 3A$, $Charge_current = 1A$, $System_load = 0.5A$ to $8A$

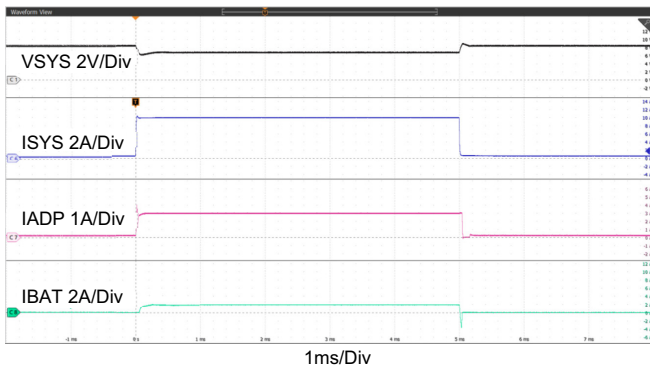

Figure 37. Buck Mode, Output Voltage Loop to Adapter Current Loop Transition, $V_{ADP} = 20V$, $V_{BAT} = 7V$, $MaxSystemVoltage = 8.384V$, $Adapter_current_limit = 3A$, $Charge_current = 0A$, $System_load = 0.5A$ to $10A$

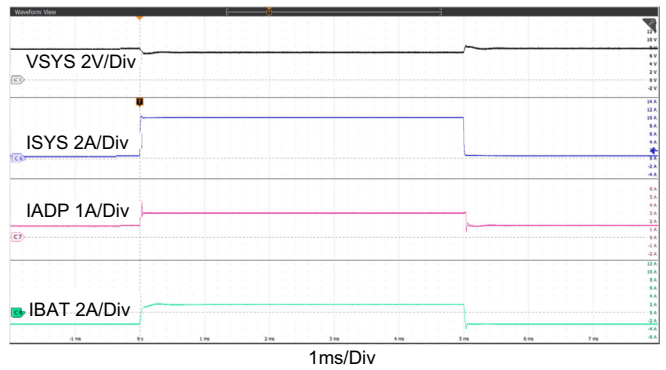

Figure 38. Buck Mode, Charge Current Loop to Adapter Current Loop Transition, $V_{ADP} = 20V$, $V_{BAT} = 7V$, $MaxSystemVoltage = 8.384V$, $Adapter_current_limit = 3A$, $Charge_current = 3A$, $System_load = 0.5A$ to $10A$

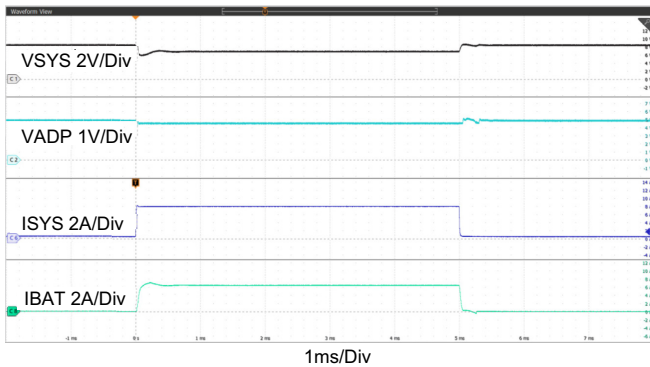

Figure 39. Boost Mode, Output Voltage Loop to Input Voltage Loop Transition, $V_{ADP} = 5V$, $V_{BAT} = 8V$, $MaxSystemVoltage = 8.384V$, $Charge_current = 0A$, $System_load = 0.5A$ to $8A$, $Input_voltage_dac = 4.437V$

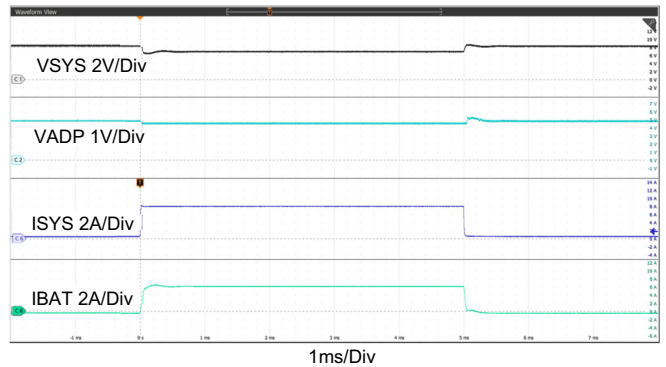

Figure 40. Boost Mode, Charge Current Loop to Input Voltage Loop Transition, $V_{ADP} = 5V$, $V_{BAT} = 8V$, $MaxSystemVoltage = 8.384V$, $Charge_current = 0.5A$, $System_load = 0.5A$ to $8A$, $Input_voltage_dac = 4.437V$

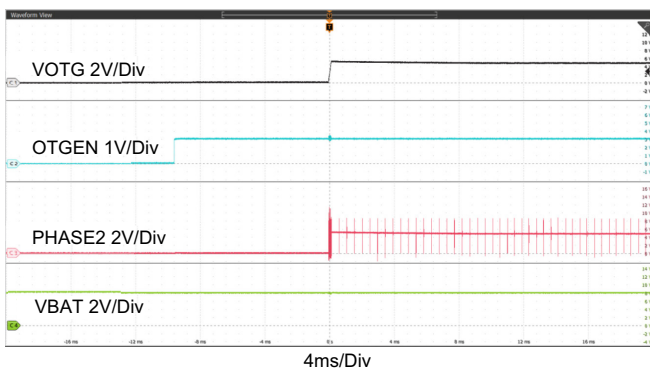

Figure 41. OTG Mode Enable Using OTGEN Pin, $V_{BAT} = 8V$, $V_{OTG} = 5V$, General Purpose Comparator Disabled, OTGEN Control Bit Enabled

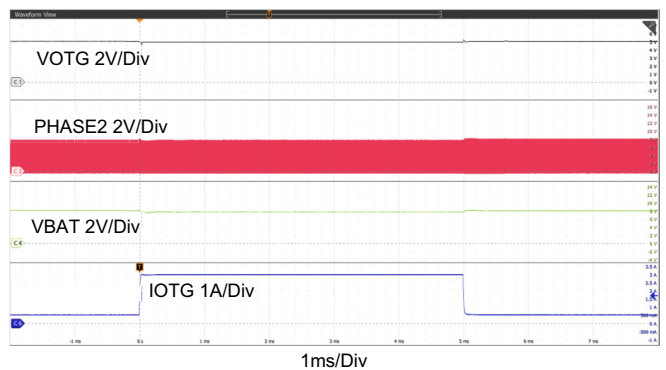

Figure 42. OTG Mode Transient. $V_{BAT} = 8V$, $V_{OTG} = 5V$, OTG Current = $3.2A$, Load = $0.5A$ to $3A$

6. Ordering Information

Part Number	Description
RTKA489000DE0000BU	RAA489000 buck-boost charger evaluation board

7. Revision History

Revision	Date	Description
1.01	Jan 20, 2023	Updated layout guidelines, schematics, and BOM.
1.00	Apr 16, 2021	Initial release

IMPORTANT NOTICE AND DISCLAIMER

RENESAS ELECTRONICS CORPORATION AND ITS SUBSIDIARIES (“RENESAS”) PROVIDES TECHNICAL SPECIFICATIONS AND RELIABILITY DATA (INCLUDING DATASHEETS), DESIGN RESOURCES (INCLUDING REFERENCE DESIGNS), APPLICATION OR OTHER DESIGN ADVICE, WEB TOOLS, SAFETY INFORMATION, AND OTHER RESOURCES “AS IS” AND WITH ALL FAULTS, AND DISCLAIMS ALL WARRANTIES, EXPRESS OR IMPLIED, INCLUDING, WITHOUT LIMITATION, ANY IMPLIED WARRANTIES OF MERCHANTABILITY, FITNESS FOR A PARTICULAR PURPOSE, OR NON-INFRINGEMENT OF THIRD PARTY INTELLECTUAL PROPERTY RIGHTS.

These resources are intended for developers skilled in the art designing with Renesas products. You are solely responsible for (1) selecting the appropriate products for your application, (2) designing, validating, and testing your application, and (3) ensuring your application meets applicable standards, and any other safety, security, or other requirements. These resources are subject to change without notice. Renesas grants you permission to use these resources only for development of an application that uses Renesas products. Other reproduction or use of these resources is strictly prohibited. No license is granted to any other Renesas intellectual property or to any third party intellectual property. Renesas disclaims responsibility for, and you will fully indemnify Renesas and its representatives against, any claims, damages, costs, losses, or liabilities arising out of your use of these resources. Renesas' products are provided only subject to Renesas' Terms and Conditions of Sale or other applicable terms agreed to in writing. No use of any Renesas resources expands or otherwise alters any applicable warranties or warranty disclaimers for these products.

(Rev.1.0 Mar 2020)

Corporate Headquarters

TOYOSU FORESIA, 3-2-24 Toyosu,
Koto-ku, Tokyo 135-0061, Japan
www.renesas.com

Contact Information

For further information on a product, technology, the most up-to-date version of a document, or your nearest sales office, please visit:
www.renesas.com/contact/

Trademarks

Renesas and the Renesas logo are trademarks of Renesas Electronics Corporation. All trademarks and registered trademarks are the property of their respective owners.