

RTKA489EPRDE0010BU

140W USB Type-C Battery System Reference Design for 2 to 7S Li-Ion

Description

The RTKA489EPRDE0010BU (RTK-G015-EPRSinkCharger (140W)) is a Universal Serial Bus Power Delivery (USB PD) evaluation board that supports 2 to 7 battery cells in series configuration. The RTK-G015-EPRSinkCharger is designed with 48V USB-C Port Controller (SPR/EPR TCPC) RAA489400, USB-C Port Manager (TCPM) R9A02G0151, and On-Board Charger RAA489118. There are two types of RTK-G015-EPRSinkCharger-140W supports 28V/140W USB Type-C® EPR input. This document is the instruction manual for the RTK-G015-EPRSinkCharger.

The RTK-G015-EPRSinkCharger supports USB PD 2.0, USB PD 3.1, and USB Type-C Specification. The RTK-G015-EPRSinkCharger works as a USB Type-C EPR power sink charger or an EPR power bank. The RTK-G015-EPRSinkCharger does not have a battery protection circuit on the board, so, Renesas strongly recommends using a battery module with Renesas' Battery Management System to avoid over-discharging under the power bank mode. The RTK-G015-EPRSinkCharger may be combined with an Evaluation Module of the Battery Fuel Gauging IC (FGIC) RAJ2400100 with Filefish to realize a complete Battery Management System (BMS).

The configuration switches enable the selection of the number of battery cells, the maximum charge current and the operating mode.

VIDWriter 1.2.1.0 applies to the RTK-G015-EPRSinkCharger.

Target Devices

- 140W USB Type-C Charger or MAX 140W Power Bank: RTK-G015-EPRSinkCharger-140W
 - 48V USB-C Port Controller (SPR/EPR TCPC): RAA489400
 - USB-C Port Manager (TCPM): R9A02G0151
 - On-Board Charger: RAA489118
- Evaluation Module of Battery Fuel Gauging IC (FGIC) with Filefish: RAJ2400100 Filefish EVM
 - Battery Fuel Gauging IC: RAJ2400100

Target VIDWriter: VIDWriter 1.2.1.0 (Version 1.2.1.0)

Related Documents

Use this document in combination with the following documents.

The related documents mentioned in this publication may include preliminary versions. However, preliminary versions are not marked as such.

- RAA489400 Datasheet: R16DS0292EU
- R9A02G0151 Datasheet: R19DS0101EJ
- E1 Emulator E20 Emulator User's Manual: R20UT0398EJ??
- E2 Emulator Lite User's Manual: R20UT3240EJ
- E1/E20 Emulator, E2 Emulator Lite Additional Document for User's Manual (Notes on Connection of RL78): R20UT1994EJ
- Renesas Flash Programmer V3.13 Flash memory programming software User's Manual: R20UT5312EJ
- USB Power Delivery Controller VIDWriter 1.2.1.0 Instruction Manual: R19AN0294EJ
- RAA489118 Short-Form Datasheet: R16DO0024EU

- RAJ240100 Datasheet: R01DS0301EJ
- RAJ240100 Filefish User's Manual: R01AN6763EJ

Contents

1. Features	3
1.1 Block Diagram	4
1.2 Component	5
1.2.1 Component Layout	5
1.2.2 Component Information	6
1.3 Function assignment for RAA489400 on RTK-G015-EPRSinkCharger	7
1.4 Function assignment for R9A02G0151 on RTK-G015-EPRSinkCharger	8
1.5 Function assignment for RAA489118 on RTK-G015-EPRSinkCharger	9
2. Function	10
2.1 Battery Configuration	10
2.2 Charging Current Limits	11
2.3 Operating Mode Selection	12
2.3.1 Sinking mode	13
2.3.2 Sourcing mode	13
3. Board setup and usage	15
3.1 Required Materials	15
3.2 Connecting Battery Module	15
3.2.1 Charging Battery Module with the Standard Charger Parameters (Board Mode) without Renesas BMS Interface	15
3.2.2 Charging Battery Module with the Custom Charger Parameters (Manual Mode) without Renesas BMS Interface	16
3.2.3 Charging Battery Module with Renesas BMS Interface	16
3.2.4 Power Bank Mode Setting	17
3.3 Battery Module with Renesas BMS Interface	17
3.3.1 RAJ240100 Filefish EVM Connection	17
3.3.2 RAJ240100 Filefish EVM	18
3.4 Firmware Writing to the R9A02G0151 on RTK-G015-EPRSinkCharger	19
3.4.1 FW Generation	19
3.4.2 Outline of Flash Memory Writing	23
3.4.3 FW Writing with Renesas On-Chip Debugging Emulator	24
4. Optional Features	27
4.1 Supports USB Peripheral Function	27
4.2 Supports SMBus Target Interface	28
5. Ordering Information	28
6. Revision History	28

1. Features

RTK-G015-EPRSinkCharger-140W supports the following features.

- USB Power Delivery and USB Type-C
 - Supports USB Power Delivery Specification Revision 2.0, USB Power Delivery Specification Revision 3.1, USB Type-C Cable and Connector Specification Revision 2.2.
 - Supported features
 - Power Role: Sink Only (SNK) or Dual Role Power (DRP)
 - Under Sink Only mode, RTK-G015-EPRSinkCharger-140W requires SPR mode 5, 9, 15, 20V or EPR mode 28V input from USB Type-C power sourcing device.
 - Under Power Bank (DRP) mode, RTK-G015-EPRSinkCharger-140W requires SPR mode 5, 9, 15, 20V or EPR mode 28V input from USB Type-C power sourcing device in sinking mode and supports source PDP ratings of 15W, 27W, 45W, 60W, 100W, or 140W in sourcing mode.
 - Certified by USB Implementers Forum
 - RAA489400: TID = [10147](#)
 - R9A02G0151: TID = [8183](#)
 - 1 USB Type-C port
- Interface
 - LED indicators
 - Power Supply Indicator (2 LEDs, green)
One is for Sinking LED and the other is for Sourcing LED
 - Indicators from R9A02G0151 (3 LEDs, red)
 - Switches
 - Battery Configuration control for RAA489118
 - Charging Current limits control for R9A02G0151
 - On-chip debugging emulator interface
 - Renesas on-chip debugging emulator interface to write and debug firmware for R9A02G0151
 - Battery Management System interface
 - Renesas BMS evaluation board interface to communicate with Battery module including FGIC
 - The input voltage of the battery charger is from Type-C sourcing device negotiated with the R9A02G0151

1.1 Block Diagram

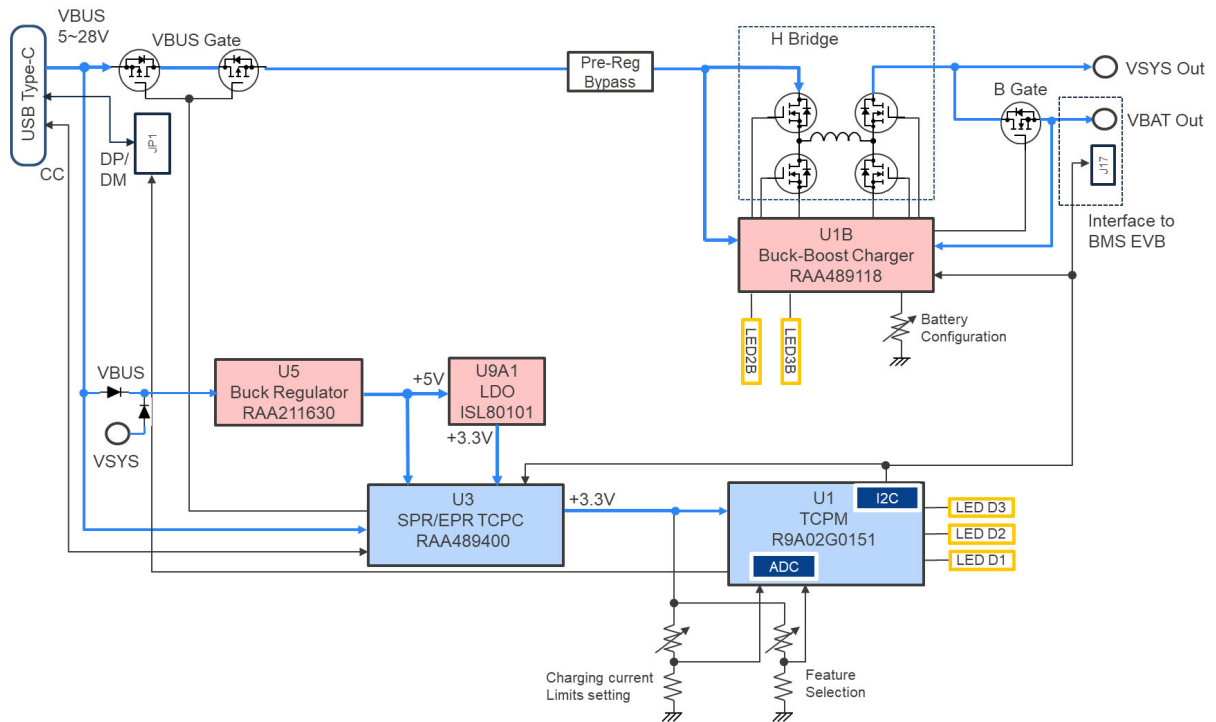

Figure 1. RTK-G015-EPRSinkCharger-140W Block Diagram (RTKA489EPRDE0010BU: 28V EPR Mode)

1.2.2 Component Information

Table 1. ICs

No.	Description	Remark
U1	R9A02G0151 (USB-C Port Manager: TCPM)	-
U3	RAA489400 (48V USB-C Port Controller: SPR/EPR TCPC)	-
U5A	Not available on RTK-G015-EPRSinkCharger-140W	-
U1B	RAA489118 (On-Board Charger)	-
U5	RAA211630 (5V output DC/DC synchronous Buck regulator)	-
U9A1	ISL80101 (3.3V output LDO)	-

Table 2. Connectors

No.	Description	Remark
CN1	USB Type-C receptacle	-
J12	Renesas on-chip debugging emulator interface	-
JP1	USB2.0 Data interface	-
TB1/J17	Connector for Battery Management System	-
J15	SMBus Controller 2 SCL, SDA on R9A02G0151	P70, P71
J16	SMBus Controller 1 SCL, SDA alert on R9A02G0151	P53, P54, P55
J1	SMBus Target SCL, SDA, alert on R9A02G0151	P62, P63, P64

Table 3. Switches

No.	Description	Connects to
SW1	Rotary switch for setting the Charger Current Limit	R9A02G0151: P25
SW3	Rotary switch for Operating Mode selection	R9A02G0151: P24
SW1B	Rotary switch for configuration of number of Battery cells	RAA489118: PROG

Table 4. LEDs

No.	Description	Remark
D0	Indicator 0 from R9A02G0151 (red)	Indicates the HW setting error
D1	Indicator 1 from R9A02G0151 (red)	Indicates EPR mode
D2	Indicator 2 from R9A02G0151 (red)	Indicates power on reset
D2B	Power Supply Indicator for Sink mode (green)	-
D3B	Power Supply Indicator for Source mode (green)	-

Table 5. Test Points

No.	Description	Remark
TP90A	VIN	-
TP2B, TP81A, TP91A	GND	-
TP1B	VADP (Monitor for Battery Charger input)	-
TP28B	VSYS (DC output)	-

1.3 Function assignment for RAA489400 on RTK-G015-EPRSinkCharger

Table 6 shows the functions assigned to RAA489400 on RTK-G015-EPRSinkCharger.

Table 6. Functions Assigned to RAA489400 Pins on RTK-G015-EPRSinkCharger

Pin name	Function	Descriptions
NC_1	Open	-
CC1	CC1	Configuration Channel 1, Analog pin from CC-PHY
RD1	RD1	Rd resistor 1, Analog pin from CC-PHY.
VDD25	VDD25	Connected a capacitor to GND.
GPIO4	Open	-
GPIO3	Open	-
GPIO2	GATE	Gate drive output of N-Channel MOSFET V_{BUS} Source (greater than 5V) path.
GPIO1	GATE	Gate drive output of N-Channel MOSFET V_{BUS} Source (greater than 5V) path.
OCP#	Open	-
PROG	Pull-down	Set SMBus target address.
NC_11	Open	-
VSYS33	VDD	Power supply (+3.3V).
VDD33	VDD	Power supply (+3.3V) connected to R9A02G0151
VBUS	VBUS	USB-C V_{BUS} input (~48V).
CSIP	CSIP	Current sense positive input from V_{BUS} path.
CSIN	CSIN	Current sense negative input from V_{BUS} path.
NC_17	Open	-
VSNK_GATE	GATE	Gate drive output of N-Channel MOSFET V_{BUS} Sink path.
VSNK_SRC	REF	N-Channel MOSFET source input reference for V_{BUS} Sink path FET(s).
VSINK_DISCHG	DISCHG	V_{BUS} Sink path discharge.
VSRC_GATE	GATE	Gate drive output of N-Channel MOSFET V_{BUS} Source (5V) path.
VSRC_SRC	REF	N-Channel MOSFET source input reference for V_{BUS} Source (5V) path FET(s).
VSRC_BOOT	REF	N-Channel MOSFET source input reference for V_{BUS} Source (5V) path FET(s).
GND	GND	Ground
RD2	RD2	Rd resistor 2, Analog pin from CC-PHY.
CC2	CC2	Configuration Channel 2, Analog pin from CC-PHY.
NC_27	NC	-
SCL	MSTSCL1	SMBus target clock input connected to R9A02G0151.
SDA	MSTSDA1	SMBus target data input/output (open-drain) connected to R9A02G0151.
VCONN_POWER	V_{CONN}	Power supply (+5V) for V_{CONN} .
ALERT#	ALERT#1	SMBus target ALERT# output (open-drain) connected to R9A02G0151.
PROCHOT#	Open	-
CC1_EP	CC1	Configuration Channel 1, Analog pin from CC-PHY.
CC2_EP	CC2	Configuration Channel 2, Analog pin from CC-PHY.

1.4 Function assignment for R9A02G0151 on RTK-G015-EPRSinkCharger

Table 7 shows the functions assigned to R9A02G0151 on RTK-G015-EPRSinkCharger.

Table 7. Functions Assigned to R9A02G0151 Pins on RTK-G015-EPRSinkCharger

Pin name	Function	Descriptions
P40	TOOL0	Connected to on-chip debugging emulator interface for flash programming.
RESETB	RESETB	Chip Reset Input (active low)
P137	Open	-
P122	Open	-
P121	SOURCE Mode	Connected to OTGPG/CMOut# of On-Board Charger.
REGC	REGC	Regulator capacitance. Connecting regulator output stabilization capacitance for internal operation.
VDD	VDD	Power supply (+3.3V)
P60	Pull-down	Unused
GND	GND	Ground
P61	Open	-
P62	SLVSCL	SMBus target clock input connected to J1
P63	SLVSDA	SMBus target data input/output (open-drain) connected to J1
P64	SLVALTB	Connected to J1
P50	Open	Unused
P51	DRP	Connected to OTGEN/CMIN of On-Board Charger.
P52	PGOOD	Connected to PGOOD of 48V 3-Level Buck Pre-Regulator. Unused on RTK-G015-EPRSinkCharger-140W.
P53	MSTSCL1	SMBus controller clock output (open-drain) connected to RAA489400
P54	MSTSDA1	SMBus controller data input/output (open-drain) connected to RAA489400
P55	ALERT#1	SMBus controller ALERT# input connected to RAA489400
P70	MSTSCL2	SMBus controller clock output (open-drain) connected to RAA489118.
P71	MSTSDA2	SMBus controller data input/output (open-drain) connected to RAA489118.
UVDD	VDD	Power supply (+3.3V)
P72	Open	-
P73	Open	-
P74	UFP	Attached UFP on USB2.0 interface header
P25	SW1	Input from Rotary Dip switch for Charging Current Limits control
P24	SW3	Input from Rotary Dip switch for Operating Mode Selection
P23	SINK Mode	Connected to ACOK of On-Board Charger.
P22	INDICATOR 3	Indicator 3, connected to D2. It indicates that the power-on reset has been performed.
P21	INDICATOR 2	Indicator 2, connected to D1. It indicates the board is in EPR mode.
P20	INDICATOR 1	Indicator 1, connected to D0. It indicates the HW setting error
P01	INT	Connected to INT#/CMOut# of 48V 3-Level Buck Pre-Regulator. Unused on RTK-G015-EPRSinkCharger-140W.
P00	Open	-

1.5 Function assignment for RAA489118 on RTK-G015-EPRSinkCharger

Table 8 shows the functions assigned to RAA489118 on RTK-G015-EPRSinkCharger.

Table 8. Functions Assigned to RAA489118 Pins on RTK-G015-EPRSinkCharger

Pin name	Function	Descriptions
CSON	CSON	Battery current sense negative input
CSOP	CSOP	Battery current sense positive input
VSYS	VSYS	Provides feedback voltage for System Voltage regulation.
BOOT2	BT2	High-side MOSFET Q4 gate driver supply
UGATE2	UG2	High-side MOSFET Q4 gate drive
PHASE2	PH2	Current return path for the high-side MOSFET Q4 gate drive
LGATE2	LG2	Low-side MOSFET Q3 gate drive
VDDP	VDDP	Power supply for the gate drivers
LGATE1	LG1	Low-side MOSFET Q2 gate drive
PHASE1	PH1	Current return path for the high-side MOSFET Q1 gate drive
UGATE1	UG1	High-side MOSFET Q1 gate drive
BOOT1	BT1	High-side MOSFET Q1 gate driver supply
ASGATE	Open	Unused
CSIN	CSIN	Current sense negative input from V_{BUS} path
CSIP	CSIP	Current sense positive input from V_{BUS} path
ADP	ADP	Voltage Sense input from V_{BUS} path
DCIN	DCIN	Internal LDO input that provides power to the IC
VDD	VDD	Internal LDO output that provides the bias power for the internal circuit
ACIN	ACIN	V_{BUS} voltage sense input
OTGEN/CMIN	DRP	Connected to P51 of R9A02G0151
SDA	SDA	SMBus target data input/output (open-drain) connected to R9A02G0151
SCL	SCL	SMBus target clock input connected to R9A02G0151
PROCHOT#	PROCHOT#	Unused
ACOK	SINK Mode	Power Supply Indicator, connected to P23 of R9A02G0151 and D2B
BATGONE	BATGONE	Battery presence input
OTGPG/CMOUT	SOURCE Mode	Connected to P121 of R9A02G0151 and D3B
PROG	PROG	Input from Rotary switch for Configuration of the number of battery cells
COMP	COMP	Error amplifier output
AMON/BMON	AMON/BMON	Unused
CONFIG/PSYS	PSYS	Unused
VBAT	VBAT	Battery voltage sense input
BGATE	BGATE	Gate drive output to the P-channel FET connecting the system and the battery

2. Function

2.1 Battery Configuration

Battery Configuration is set by SW1B.

Table 9. Rotary switch setting value for Battery Configuration

SW Position	RTK-G015-EPRSinkCharger
1	2 Cells in series
2	3 Cells in series
3	4 Cells in series
4	5 Cells in series
5	6 Cells in series
6	7 Cells in series

The standard charger parameters in firmware (FW) define MaxSysVol/cell as 4.048V and MinSysVol/cell as 2.816V, which correspond to typical voltages for Li-Ion battery chemistries such as LiCoO₂ and LiMn₂O₄ battery. [Table 10](#) shows the default MaxSysVol and MinSysVol for each battery configuration.

Table 10. Battery Configuration versus MaxSysVol/MinSysVol for LiCoO₂ and LiMn₂O₄ Battery in Standard FW

Battery Configuration	MaxSysVol (mV)	MinSysVol (mV)
2 Cells in series	8096	5632
3 Cells in series	12144	8448
4 Cells in series	16192	11264
5 Cells in series	20240	14080
6 Cells in series	24288	16896
7 Cells in series	28336	19712

For example, the MaxSysVol/cell and MinSysVol/cell for a LiFePO₄-based battery are lower than those of other Li-Ion batteries such as LiCoO₂ and LiMn₂O₄ batteries. Therefore, if using other MaxSysVol and MinSysVol values are required, VIDWriter 1.2.1.0 can generate a FW with such parameters. See [Charging Current Limits](#) and [Firmware Writing to the R9A02G0151 on RTK-G015-EPRSinkCharger](#) for more details. The Charger MaxSysVol range is 8V to 30.8V and the Charger MinSysVol range is 5.12V to 25.088V, so the user can only set MaxSysVol and MinSysVol with these ranges.

[Table 11](#) shows sample MaxSysVol and MinSysVol for each battery configuration of LiFePO₄ based batteries with MaxSysVol/cell at 3.4V and MinSysVol/cell at 2.2V.

Table 11. Battery Configuration versus Sample MaxSysVol/MinSysVol for LiFePO₄ Battery

Battery Configuration	MaxSysVol (mV)	MinSysVol (mV)
3 Cells in series	10200	6600
4 Cells in series	13600	8800
5 Cells in series	17000	11000
6 Cells in series	20400	13200
7 Cells in series	23800	15400
8 Cells in series	27200	17600

MaxSysVol represents the maximum battery charging voltage. It is defined as Full in this document. If VBAT reaches the Full value, the charger operates in Constant Voltage mode. MinSysVol represents the minimum allowed voltage during discharging mode. It is defined as Empty in this document. In charging mode, when VBAT is less than the Empty value, the Charger trickle charges the battery at a low current level. When VBAT is between Full and Empty value, the charger operates in Constant Current mode.

Standard FW includes both MaxSysVol and MinSysVol values that are matched to the battery cell configuration set by rotary switch SW1B. If the battery configuration is fixed, the resistor values in Table 12 can be used in place of the rotary switch.

Table 12. Resistor Values for Substitute Circuit

Battery Configuration	Resistor value (kΩ) for RAA489118 ^[1]
2 Cells in series	52.3
3 Cells in series	82.5
4 Cells in series	118
5 Cells in series	162
6 Cells in series	215
7 Cells in series	287

1. Resistor value within a tolerance of ±1% must be used.

2.2 Charging Current Limits

SW1 is used to set Charging Current Limits and operating mode.

There are three operating modes: Board, BMS, and Manual. The default firmware uses Board mode, in which the switches on the board configure the EVB parameters. BMS sets EVB parameters by battery status information from BMS. Manual can set EVB parameters directly using the VIDwriter.

Note: To use Board DRP, or BMS DRP, Manual modes, FW on the board must be rewritten by the VIDWriter 1.2.1.0-generated FW. If operating mode is changed to Board or BMS from Manual, FW on the board also must be rewritten by the VIDWriter 1.2.1.0-generated FW.

Table 13. Rotary Switch Setting Value for Charging Current Limits

SW Position	Charging Current Limits (SW1)	Operating Mode
0	The specific values (MaxSysVol, MinSysVol, and Charging Current limit) can be set in FW	Manual
1	2A	Board (Default)
2	4A	
3	6A	
4	8A	
5	10A	
6	12A	
7	The values (MaxSysVol, Charging Current limit and so on) are retrieved via BMS interface	BMS

When using a battery evaluation module such as RAJ240100 Filefish EVM, SW1 must be set to SW position 7. In that case, R9A02G0151 of RTK-G015-EPRSinkCharger retrieves battery related information from FGIC controller on RAJ240100 Filefish EVM. The R9A02G0151 then uses the information obtained from FGIC controller instead of SW1 value to configure the on-board charger. At the same time, R9A02G0151 gets the number of series cells

that the battery module has. Therefore, the SW1B setting is ignored at this case. FW is generated by VIDWriter 1.2.1.0 (see [Firmware Writing to the R9A02G0151 on RTK-G015-EPRSinkCharger](#)).

If SW1 does not have a suitable charging current value and/or user does not want to set MaxSysVol and MinSysVol as standard values, user needs to set SW1 to SW position 0 and set the expected charging current value, MaxSysVol and MinSysVol. Install them on FW that is generated by using the VIDWriter 1.2.1.0 as described in [Firmware Writing to the R9A02G0151 on RTK-G015-EPRSinkCharger](#). In this case, the SW1B setting is ignored.

If the charging current limit is fixed, the substitute circuit as shown in [Figure 3](#) can be used in place of the rotary switch.

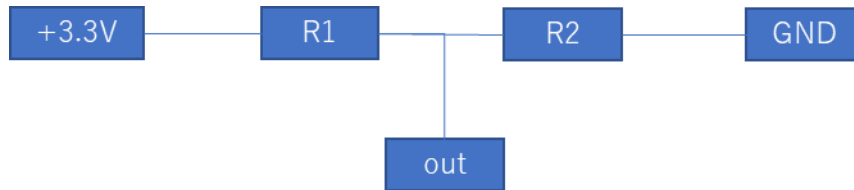

Figure 3. The Substitute Circuit for Output Voltage or Current

The resistor values in [Table 14](#) can be used to define input level of P25.

Table 14. Resistors Values for Substitute Circuit

SW Position	Resistor value (Ω) ^[1]	
	R1	R2
0	Pull down to GND	
1	3.3k	2.7k
2	2.2k	2.7k
3	1.5k	2.7k
4	1.2k	2.7k
5	1k	2.7k
6	820	2.7k
7	Pull up to VDD	

1. R1 and R2 within a tolerance of ±5% must be used.

2.3 Operating Mode Selection

Operating Mode selection is set by SW3.

Table 15. Rotary Switch Setting Value for Operating Mode Selection

SW Position	RTK-G015-EPRSinkCharger-140W Operating Mode Selection (SW3)
0	28V/140W EPR DRP mode 28V Sink and 28V Source
1	Prohibited (future use)
2	Prohibited (future use)
3	28V/140W EPR Sink Only mode
4	Prohibited (future use)
5	Prohibited (future use)

Table 15. Rotary Switch Setting Value for Operating Mode Selection

SW Position	RTK-G015-EPRSinkCharger-140W Operating Mode Selection (SW3)
6	Prohibited (future use)
7	Prohibited (future use)

The circuit as shown in [Figure 3](#) can be used in place of the rotary switch. The resistor values in [Table 14](#) can be used to define input level of P24.

2.3.1 Sinking mode

Under Sink Charger operation and sinking mode for Power Bank operation, RAA489400 + R9A02G0151 needs the sourcing PDP rating as shown in [Table 16](#) to the connected PD sourcing device to realize fast charging when $V_{BAT} > MinSysVol$. Even if the connected PD sourcing device cannot supply the sourcing PDP rating that is shown in [Table 16](#), RTK-G015-EPRSinkCharger charges the battery with the USB-C input power that the PD adapter can supply. For example, when a product may charge at 5V, 9V and 15V, differentiation between 5V, 9V, and 15V charging voltage is charging speed.

Table 16. The Expected Maximum Type-C Sourcing PD Power for Sinking Mode

Battery Configuration	2A	4A	6A	8A	10A	12A
2 Cells in series	3A@9V	3A@15V	3A@20V	4A ^[1] @20V	5A ^[1] @20V	4A ^[2] @28V
3 Cells in series	2A@15V	3A@20V	5A ^[1] @20V	4A ^[2] @28V	5A ^[2] @28V	5A ^[2] @28V
4 Cells in series	3A@15V	4A ^[1] @20V	4A ^[2] @28V	5A ^[2] @28V	5A ^[2] @28V	5A ^[2] @28V
5 Cells in series	3A@20V	5A ^[1] @20V	5A ^[2] @28V	5A ^[2] @28V	5A ^[2] @28V	5A ^[2] @28V
6 Cells in series	3A@20V	4A ^[2] @28V	5A ^[2] @28V	5A ^[2] @28V	5A ^[2] @28V	5A ^[2] @28V
7 Cells in series	4A ^[1] @20V	5A ^[2] @28V	5A ^[2] @28V	5A ^[2] @28V	5A ^[2] @28V	5A ^[2] @28V

1. EPR cable or 5A cable is required.
2. EPR cable is required.

The BB-Charger co-works with a battery module. Charging modes for the Battery module are Trickle, Constant Current (CC), and Constant Voltage (CV). As long as V_{BAT} is less than Empty, the charging current is set to 256mA. If V_{BAT} is in between Full and Empty, the charger operates in Constant Current mode. If V_{BAT} reaches Full, the charger works in Constant Voltage mode. If $V_{BAT} > MaxSysV$, there is no charging/switching.

The current limit during CC and CV modes is defined by the lesser of the charger's current limit and the Type-C input current limit. When the battery is 7 cells (Full = 28.336V and Empty = 19.712V for Li-Ion batteries such as $LiCoO_2$ and $LiMn_2O_4$ battery) and Type-C input is 100W, actual charging current is limited to around 3.4A at Full even if the Charging Current Limits is set to 6A. On the other hand, at a voltage just over Empty, actual charging current is around 5A. As the V_{BAT} voltage approaches Full, the actual charging current reduces to 3.4A.

When the battery is 4 cells (Full = 16.192V and Empty = 11.264V for Li-Ion batteries such as $LiCoO_2$ and $LiMn_2O_4$ battery) and Type-C input is 100W, actual charging current nearly reaches the 6A charging current limit at the Full voltage. At just over Empty, it is possible to supply over 9A charging current from Type-C input. However, because the charger's current limitation is 6A, the charger can only supply a maximum of 6A to the battery.

Both the 5A and EPR cables have the e-markers to notify the system of 5A capability. Under EPR mode, USB-C EPR cable and USB-C EPR Charger are used.

2.3.2 Sourcing mode

Note: The RTK-G015-EPRSinkCharger does not have a battery protection circuit on the board, therefore, Renesas strongly recommends using a battery module with Renesas' Battery Management System to avoid over-discharging under the power bank mode. RTK-G015-EPRSinkCharger can support power bank mode as

long as the battery module uses protection circuit to avoid over-discharge or over-temperature. However, this should be done at user's own risk.

Under sourcing mode for Power Bank operating, RTK-G015-EPRSinkCharger supports the standard maximum sourcing PD Power as shown in Table 17 based Equation 1.

(EQ. 1) Available Sourcing Power = MinSysVol × Charging Current Limit × 2

- The standard PD Power in FW = Max supply current (3 or 5A) × Standard supply voltage (SPR: 5, 9, 15, or 20V, EPR: 28V) = 15, 27, 45, or 60W (SPR and 3A cable), or 100W (SPR and 5A cable), or 140W (EPR)
- The Max sourcing PD Power in FW ≤ Available sourcing power

The max sourcing PDP is calculated by the MinSysVol value and Charging Current Limit value. For example, if the MinSysVol is 11.2V and the charging current limit is 2A, the available sourcing power is 44.8W. As a result, the maximum sourcing PDP of the FW is 27W. When the MinSysVol is 19.6V and the charging current limit is 4A, the available sourcing power is 156.8W. Therefore, the user can choose either 15, 27, 45, 60, 100, or 140W as the sourcing PDP. The Max sourcing PDP is calculated by the above formula even though MaxSysVol, MinSysVol, and Charging Current Limits are set manually.

When the operating mode is BMS, the FW cannot recognize the MaxSysVol, MinSysVol, and Charging Current Limits until R9A02G0151 retrieves the battery information from BMS. Therefore, set the appropriate Max sourcing PD Power that battery module can support.

The USB-PD PDO list, which is used on PD negotiation, is generated by this Max sourcing PDP.

Table 17. Supported Maximum Type-C Sourcing PD Power for Sourcing Mode

Battery Configuration	2A	4A	6A	8A	10A	12A
2 Cells in series	15W	45W	60W	60W	100W ^[1]	100W ^[1]
3 Cells in series	27W	60W	100W ^[1]	100W ^[1]	140W ^[2]	140W ^[2]
4 Cells in series	45W	60W	100W ^[1]	140W ^[2]	140W ^[2]	140W ^[2]
5 Cells in series	45W	100W ^[1]	140W ^[2]	140W ^[2]	140W ^[2]	140W ^[2]
6 Cells in series	60W	100W ^[1]	140W ^[2]	140W ^[2]	140W ^[2]	140W ^[2]
7 Cells in series	60W	140W ^[2]	140W ^[2]	140W ^[2]	140W ^[2]	140W ^[2]

1. EPR cable or 5A cable is mandatory to realize this max PDP.
2. EPR cable is mandatory to realize this max PDP.

Table 18. PDO List

	SPR PDO1	SPR PDO2	SPR PDO3	SPR PDO4	EPR PDO1	EPR PDO2
PDP 15W	5V/3A	-	-	-	-	-
PDP 27W	5V/3A	9V/3A	-	-	-	-
PDP 45W	5V/3A	9V/3A	15V/3A	20V/2.25A	-	-
PDP 60W	5V/3A	9V/3A	15V/3A	20V/3A	-	-
PDP 100W	5V/3A	9V/3A	15V/3A	20V/5A ^[1]	-	-
PDP 140W	5V/3A	9V/3A	15V/3A	20V/5A ^[1]	28V/5A ^[2]	28V AVS ²

1. When the connected cable does not have 5A capability, RTK-G015-EPRSinkCharger displays 20V/3A PDO instead of 20V/5A PDO.
2. When the connected cable does not have EPR capability, RTK-G015-EPRSinkCharger does not display EPR PDO. Therefore, MAX PDO is 20V/5A PDO when the connected cable has 5A capability.

3. Board setup and usage

3.1 Required Materials

- RTK-G015-EPRSinkCharger: 1 unit
- USB Type-C Cable: 1pc (When the required maximum Type-C sourcing PD Power is 20V at 5A, 5A cable or EPR cable that has 5A capability is required. Also, when the required maximum Type-C sourcing PD voltage is 28V, EPR cable is required.)

Note: This board does not require an external power supply except for the batteries.

IMPORTANT: USE THIS BOARD WHEN YOU UNDERSTAND AND AGREE THAT RENESAS DOES NOT HAVE ANY RESPONSIBILITY, INDEMNIFICATION, OR LIABILITY FOR USE OF THIS BOARD.

3.2 Connecting Battery Module

The RTK-G015-EPRSinkCharger operation is managed by the type of battery module.

3.2.1 Charging Battery Module with the Standard Charger Parameters (Board Mode) without Renesas BMS Interface

When connected to a source device, complete the following steps to charge the battery module.

1. Select the expected Charging Current Limit by setting the rotary switch (SW1) to one of positions 1 to 6 (see [Charging Current Limits](#)).
2. Select the expected battery configuration by the rotary switch (SW1B) (see [Battery Configuration](#)).
3. For Sink Only mode, set the rotary switch (SW3) to position 3. For DRP mode, set the rotary switch (SW3) to position 0 (see [Operating Mode Selection](#)).
4. If DRP mode is selected, update FW including appropriate charger parameters that is generated by the VIDWriter 1.2.1.0 to RTK-G015-EPRSinkCharger.
5. Connect the Battery module w/o Renesas BMS interface to TB1.
6. Connect the USB Type-C sourcing device to USB Type-C receptacle (CN1) using the USB Type-C Cable and supply power to the battery module. Confirm green LED (D2B) light is on.

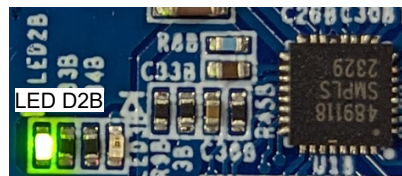

Figure 4. Power Indicator for Sink Mode

7. The board supplies power to battery module.
8. If LED D0 light is on, Operating mode/Battery configuration is not matched to actual system configuration. Check SW1, SW3, and SW1B setting and actual system configuration.

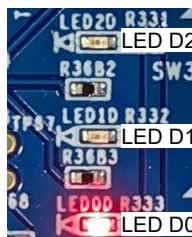

Figure 5. Error Indication

Note: Never change SW1/SW3/SW1B when the Board power is ON.

3.2.2 Charging Battery Module with the Custom Charger Parameters (Manual Mode) without Renesas BMS Interface

When connected to a source device, complete the following steps to charge the battery module.

1. Update FW including appropriate charger parameters that is generated by the VIDWriter 1.2.1.0, to RTK-G015-EPRSinkCharger.
2. Set the rotary switch (SW1) to position 0 (see Section [Charging Current Limits](#)).
3. For Sink Only mode, set the rotary switch (SW3) to position 3. For DRP mode, set the rotary switch (SW3) to position 0 (see Section [Operating Mode Selection](#)).
4. Connect Battery module w/o Renesas BMS interface to TB1.
5. Connect a USB Type-C sourcing device to the USB Type-C receptacle (CN1) using a USB Type-C Cable and supply power to the battery module. Confirm green LED (D2B) light is on as shown in [Figure 4](#).
6. The board supplies power to battery module.
7. If LED D0 light is on as shown in [Figure 5](#), Operating mode/Battery configuration is not matched to actual system configuration. Check SW1, SW3, and SW1B setting and actual system configuration.

Note: Never change SW1/SW3/(SW1B) when the Board power is ON.

3.2.3 Charging Battery Module with Renesas BMS Interface

When connected to a a source device, complete the following steps to charge the battery module.

1. For Sink Only mode, set the rotary switch (SW3) to position 3. For DRP mode, set the rotary switch (SW3) to position 0 (see [Operating Mode Selection](#)).
2. If DRP mode is selected, update FW including appropriate charger parameters that is generated by the VIDWriter 1.2.1.0, to RTK-G015-EPRSinkCharger.
3. Set the rotary switch (SW1) to position 7 (see [Charging Current Limits](#)).
4. Connect the Battery module with Renesas BMS interface to J17.
5. FW of RTK-G015-EPRSinkCharger retrieves the maximum charging voltage and current limits using the Renesas BMS interface and sets the appropriate battery charger value on RTK-G015-EPRSinkCharger.
6. Connect a USB Type-C sourcing device to the USB Type-C receptacle (CN1) using a USB Type-C Cable and supply power to the battery module. Confirm green LED (D2B) light is on as shown in [Figure 4](#).
7. The board supplies power to battery module.
8. If LED D0 light is on as shown in [Figure 5](#), Operating mode/Battery configuration is not matched to actual system configuration. Check SW1, SW3, and SW1B setting and actual system configuration.
9. FW of RTK-G015-EPRSinkCharger frequently retrieves the maximum charging voltage and current limits using the Renesas BMS interface and updates setting battery charger value on RTK-G015-EPRSinkCharger.

Note: Never change SW1/SW3/(SW1B) when the Board power is ON.

3.2.4 Power Bank Mode Setting

When using RTK-G015-EPRSinkCharger in Power Bank mode (DRP) without USB2.0 data communication, install a jumper to short DP and DM of JP1.

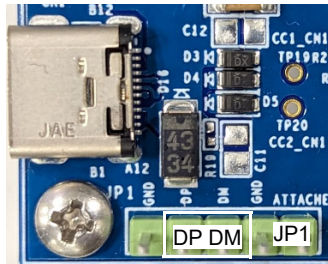

Figure 6. Connector for Power Bank Mode Setting

If using RTK-G015-EPRSinkCharger in Power Bank mode (DRP) with USB2.0 data communication, see [Supports USB Peripheral Function](#).

Connect a USB Type-C sinking device to the USB Type-C receptacle (CN1) using a USB Type-C Cable and RTK-G015-EPRSinkCharger is in Power Bank Sourcing mode, confirm green LED (D3B) light is on.

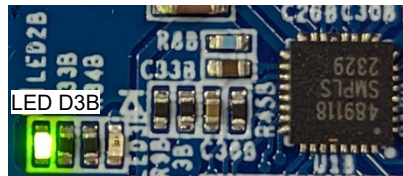

Figure 7. Power Indicator for Source Mode

3.3 Battery Module with Renesas BMS Interface

Battery module with Renesas BMS interface is described in this section. Renesas release Filefish that is a fixed firmware solution for Renesas Battery Fuel Gauging IC (FGIC), which requires no additional firmware development. Using this solution, the battery management system (BMS) can be easily and quickly designed, and the time to market can be significantly reduced.

RAJ240100 Filefish EVM is one of the battery evaluation modules including FGIC with Filefish.

RTK-G015-EPRSinkCharger communicates with RAJ240100 Filefish EVM to realize battery management system.

3.3.1 RAJ240100 Filefish EVM Connection

RAJ240100 Filefish EVM connects to RTK-G015-EPRSinkCharger using the J17 connector.

RTK-G015-EPRSinkCharger and RAJ240100 Filefish EVM interface is described in [Table 19](#).

Table 19. RTK-G015-EPRSinkCharger and Battery Module Filefish EVM Signal

Pin	RTK-G015-EPRSinkCharger	RAJ240100 Filefish EVM
1	GND	PACK-
2	GND	PACK-
3	GND	PACK-
4	P71 of R9A02G0151	SDA
5	Open	(NC)
6	P70 of R9A02G0151	SCL

Table 19. RTK-G015-EPRSinkCharger and Battery Module Filefish EVM Signal (Cont.)

Pin	RTK-G015-EPRSinkCharger	RAJ240100 Filefish EVM
7	VBATb	PACK+
8	GND	PACK-
9	VBATb	PACK+
10	VBATb	PACK+

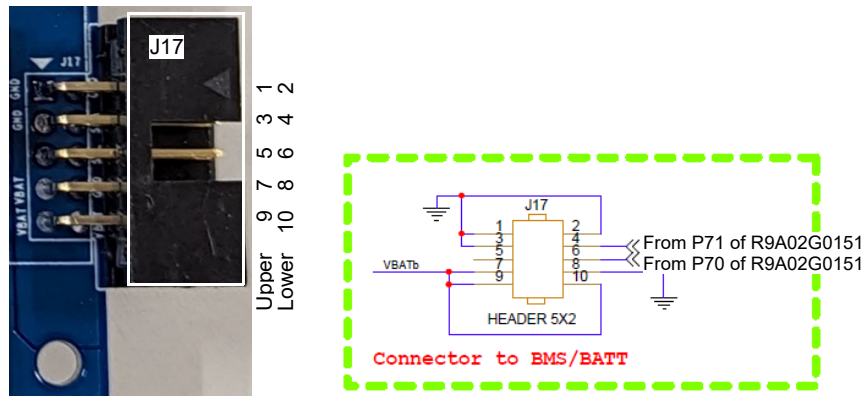

Figure 8. RTK-G015-EPRSinkCharger Connector to BMS EVB and Pin Assignment

3.3.2 RAJ240100 Filefish EVM

It is necessary to program battery management configurations to FGIC depending on customer’s application conditions. Refer to *RAJ240100 Filefish User’s Manual R01AN6763EJ* for more details.

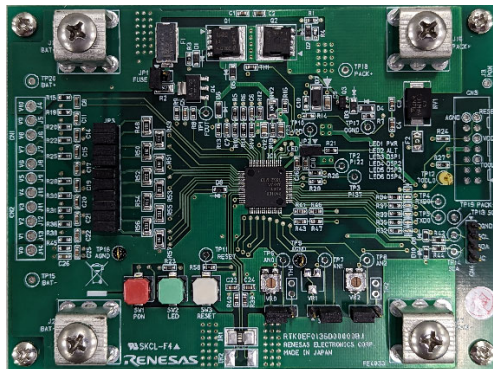

Figure 9. RAJ240100 Filefish EVM

Note: Minimum number of cells for Filefish (RAJ240100) is 3 cells in series.
For more information about Filefish, contact your Renesas representative.

3.4 Firmware Writing to the R9A02G0151 on RTK-G015-EPRSinkCharger

This section describes how to generate and write the firmware (such as Intel HEX file) to the R9A02G0151 in an appropriate method.

3.4.1 FW Generation

3.4.1.1 Operating Environment

- Host PC
 - Processor: 1GHz or faster
 - Main memory: At least 1 Gbyte
 - Display: Resolution of 1024×768 or higher and 65536 or more colors
- Supported OS
 - Windows 10 (32-bit or 64-bit)
 - Windows 11 (32-bit or 64-bit)

Note: Microsoft.NET Framework 4.6.1 or later has to be installed.

3.4.1.2 Setup the VIDWriter

1. Install Microsoft .NET Framework 4.6.1 or later.
2. Uses .exe file including in the unzip directory.
3. This tool can work without installation. DO NOT change directory structure in the unzipped data.
4. Check Tool version and FW package version in **Help > About**. VIDWriter 1.2.1.0 applies to the RTK-G015-EPRSinkCharger.

3.4.1.3 Run VIDWriter to Generate ROM Image File

When you run VIDWriter 1.2.1.0, the window as shown [Figure 9](#) displays.

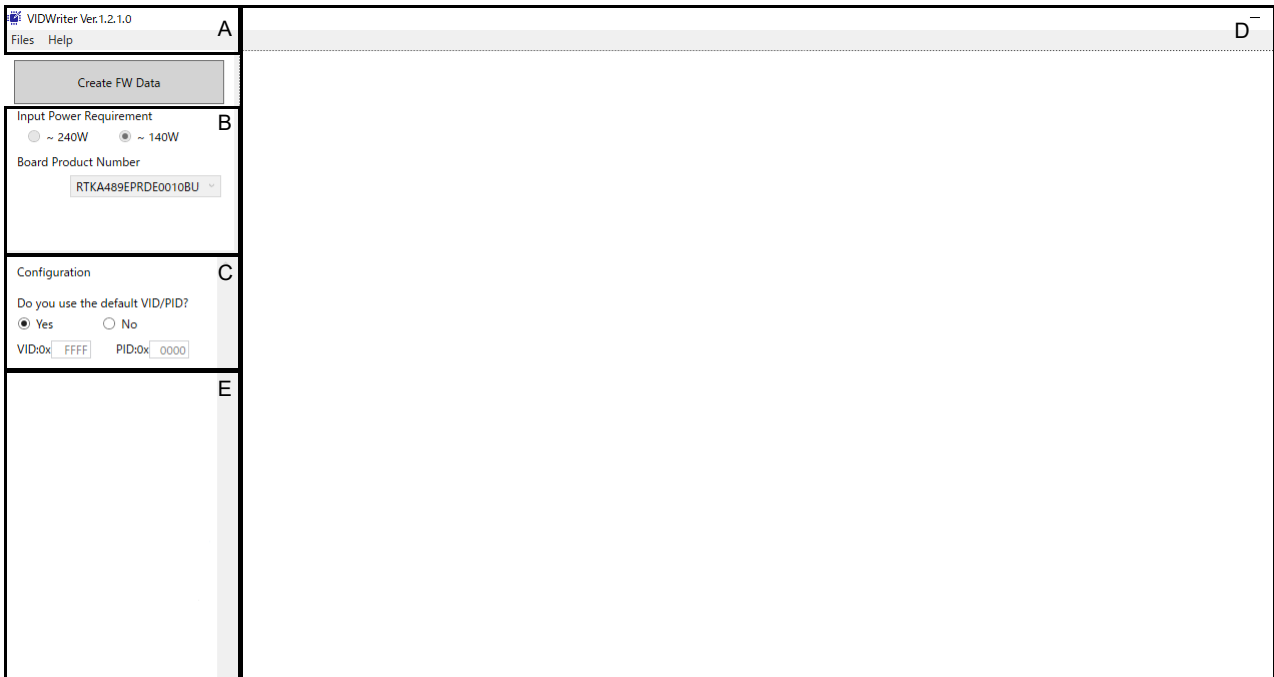

Figure 10. Main Window for VIDWriter 1.2.1.0

1. Menu Bar – Check the Tool version and FW package version in **Help > About**. VIDWriter 1.2.1.0 applies to the RTK-G015-EPRSinkCharger.
2. Field B to select the required feature – Choose the features that match the required behavior in this field. When selected, the recommended turnkey solution is displayed in Field D and the possible configurations are shown in Field E.
3. Field C to set VID/PID number – If using different hexadecimal VID and PID numbers instead of the default VID/PID(0xFFFF/0x0000) numbers set in this field, overwrite the numbers in this field. Otherwise, leave VID: FFFF and PID: 0000.
4. Window for the Renesas recommended turnkey solution – If selecting an Input Power requirement of ~140W or ~240W (Not available in this version) in Field B, the appropriate RTK-G015-EPRSinkCharger is displayed as the Renesas recommended turnkey solution in Field D.

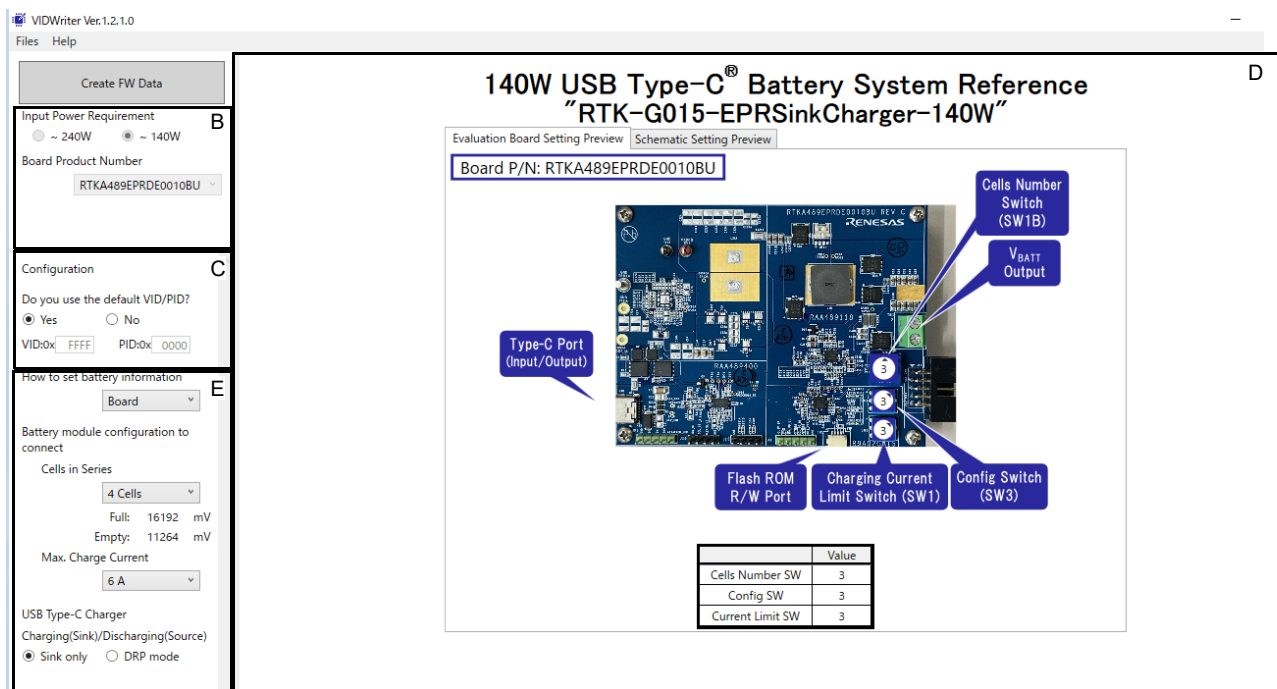

Figure 11. Main Window for VIDWriter 1.2.1.0 after Product Configuration

5. Field E configures the turnkey solution recommended by Renesas. – Field E is used to set the Full, Empty, Max Charging Current, and Max sourcing PDP (DRP mode). There are three operating modes: Board, BMS, and Manual. The default firmware uses Board and BMS mode, in which the switches on the board configure the EVB parameters. BMS sets EVB parameters by battery status information from BMS. Manual can set EVB parameters directly using the VIDwriter. After setting in Field E, Field D indicates the appropriate physical settings on the EVB. Next, set the switches on the board according to this picture.

Note: To use Board DRP, or BMS DRP, Manual modes, FW on the board must be rewritten by this VIDWriter 1.2.1.0-generated FW. If operating mode is changed to Board from BMS or Manual, FW on the board also must be rewritten by the VIDWriter 1.2.1.0-generated FW.

IMPORTANT: The RTK-G015-EPRSinkCharger does not have a battery protection circuit on the board, therefore, Renesas strongly recommends using a battery module with Renesas' Battery Management System to avoid over-discharging under the power bank mode. RTK-G015-EPRSinkCharger can support power bank mode as long as the battery module uses protection circuit to avoid over-discharge and over-temperature. However, this should be done at user's own risk.

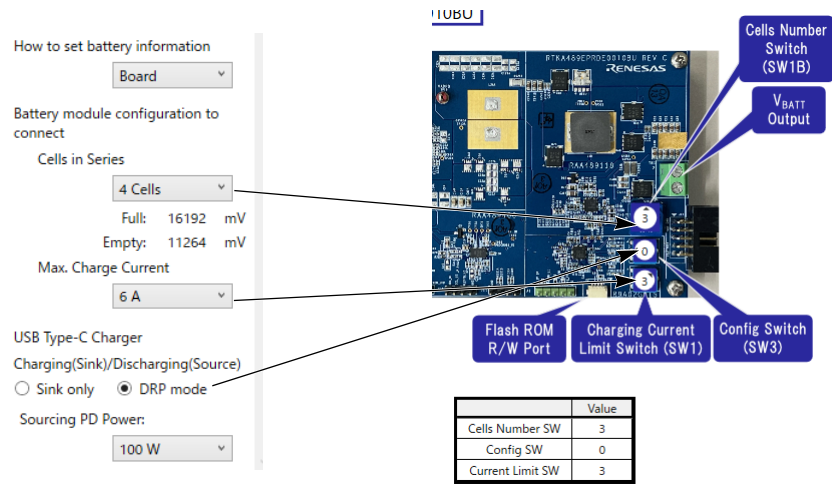

Figure 12. Field E and the EVB Setting versus Board Configuration

Full indicates the maximum battery charging voltage. Empty indicates the voltage the charger trickle charges the battery at a low current level if VBATT is below that value.

If achieving power bank function with RTK-G015-EPRSinkCharger is required, select DRP mode. Otherwise, select Sink only. In the sourcing mode of Power Bank operation, select the sourcing PD Power from the drop-down list. Because the default FW on the board supports the maximum sourcing PD Power that the board can support with current configuration, if supporting other sourcing PD Power, rewrite the FW on the board with this VIDWriter 1.2.1.0-generated FW. See [Sourcing mode](#) for more details about the maximum sourcing PDP.

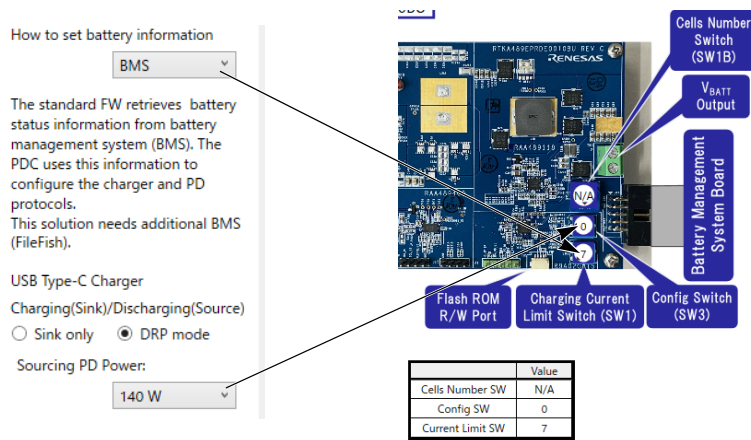

Figure 13. Field E and the EVB Setting versus BMS Configuration

In BMS setting, this EVB frequently retrieves battery related information from RAJ240100 Filefish EVM. In this operating mode, this EVB uses the information obtained from RAJ240100 Filefish EVM instead of SW1B value to configure the On-Board Charger.

If achieving the power bank function with RTK-G015-EPRSinkCharger is required, select DRP mode. Otherwise, select Sink only. In this operating mode, the FW cannot recognize the MaxSysVol, MinSysVol, and Charging Current Limits until R9A02G0151 retrieves the battery information from BMS. VIDWriter 1.2.1.0 cannot define the true maximum sourcing PD Power under sourcing mode. Therefore, set the appropriate Max sourcing PD Power that battery module can support. See [Sourcing mode](#) for more details on how to set the maximum sourcing PDP.

How to set battery information

Manual

Battery module configuration to connect

Cells in Series: 4 Cells

Full: 4048 mV/Cell
Empty: 2816 mV/Cell

Full: 16192 mV
Empty: 11264 mV

Charging Current Limit: 6000 mA

USB Type-C Charger

Charging(Sink)/Discharging(Source)

Sink only DRP mode

Sourcing PD Power: 100 W

Component	Value
Cells Number SW	N/A
Config SW	0
Current Limit SW	0

Figure 14. Field E and the EVB Setting versus Manual Configuration

If there is no suitable charging current value on SW1 and/or if setting Full and Empty as standard values is not required, set SW1 to SW position 0 and set the expected charging current value, Full and Empty. Full indicates the maximum battery charging voltage. Empty indicates the voltage the charger trickle charges the battery at a low current level if VBAT is below.

If achieving the power bank function with RTK-G015-EPRSinkCharger is required, select DRP mode. Otherwise, select Sink only. In the sourcing mode of Power Bank operating, select the sourcing PD Power from the drop-down list. See [Sourcing mode](#) for more details about the maximum sourcing PDP.

6. Press the **Schematic Setting Preview** F tab in field D and the recommended turnkey schematics with appropriated parameters are displayed as shown in [Figure 15](#).

140W USB Type-C® Battery System Reference
"RTK-G015-EPRSinkCharger-140W"

Component	Value	Unit
Cells Number Setting Resistance	118	kΩ
Config Setting Resistance R1	DNP*	
Config Setting Resistance R2	0	Ω
Charging Current Limit Setting Resistance R3	1.5	kΩ
Charging Current Limit Setting Resistance R4	2.7	kΩ

Figure 15. Main Window for VIDWriter 1.2.1.0 when Press Schematic Setting

7. Finally, when you press the **Create FW Data** button, a file save dialog is displayed. The default storage location is the **My Documents** folder. The save location and file name of the ROM image can be changed if required. If rewriting this ROM image to R9A02G0151 on the evaluation board, use the Renesas Flash Programmer V3 programming software.

3.4.2 Outline of Flash Memory Writing

The R9A02G0151 supports Serial programming interface the same as RL78 MCU series. The code flash memory can be rewritten through serial programming using a flash memory programmer.

The following dedicated flash memory programmers can be used to write data to the R9A02G0151 flash memory. For details, refer to the related tool documents.

- PG-FP6
- E1, E2, E2 Lite, E20 on-chip debugging emulator

Data can be written to the on-board flash memory by using a dedicated flash memory programmer. [Table 20](#) shows the relationship between the situation when writing the firmware and the available writing tool for the writing method using this interface.

Table 20. Firmware Writing Method and Available Writing Tool

Interface	Situations	Available writing tool	Device Configuration	R9A02G0151
Serial Programming (TOOL0)	Customer's manufacturing	Example, PG-FP6, SF2000A made by Superfly China	ON board	O
	Design debug, FW update	E1, E2, E2 Lite, E20 on-chip debugging emulator	ON board	O

3.4.2.1 On-Board Programming

The contents of the flash memory can be rewritten after the R9A02G0151 has been mounted on the target system. The connectors that the dedicated flash memory programmer uses must be mounted on the target system.

Use the Renesas Flash Programmer V3 as programming software. Refer to the following documents:

- *Renesas Flash Programmer V3.13 Flash memory programming software User's Manual (R20UT5312)*
- *List of MCUs supported by Renesas Flash Programmer V3 (R20UT3599)*
- On the development of flash memory programmer by user, refer to *RL78 microcontrollers (RL78 Protocol A) Programmer Edition Application Note (R01AN0815)*.

Flash programming for R9A02G0151 is compatible with the RL78 MCU series. Therefore, if using an available flash memory programmer that supports RL78 MCU, porting the library for that programmer is possible. Contact support for assistance.

Table 21. Wiring Between R9A02G0151 and Dedicated Flash Memory Programmer

Pin Configuration of Dedicated Flash Memory Programmer ^[1]				Pin name	Pin No.
					R9A02G0151 32pin
Signal Name		IO	Pin Function		QFN
PG-FP6	E1, E2, E2 Lite, E20 On-Chip Debugging Emulator				
SI/RxD	TOOL0	I/O	Transmit/receive signal	P40	1
/RESET	RESET	Output	Reset signal	RESETB	2

Table 21. Wiring Between R9A02G0151 and Dedicated Flash Memory Programmer (Cont.)

Pin Configuration of Dedicated Flash Memory Programmer ^[1]				Pin name	Pin No.
					R9A02G0151 32pin
Signal Name		IO	Pin Function		QFN
PG-FP6	E1, E2, E2 Lite, E20 On-Chip Debugging Emulator				
VDD	VDD	I/O	VDD voltage	VDD	7
GND	GND	-	Ground	GND Pad	GND PAD
FLMD1	EMVDD	-	Driving power for TOOL0 pin	VDD	7

1. Pins that are not indicated can be left open when using the flash memory programmer for flash programming.

3.4.3 FW Writing with Renesas On-Chip Debugging Emulator

Writing (load) firmware by Renesas on-chip debugging emulator is available. Since RTK-G015-EPRSinkCharger does not have full 14-pin connector for the emulator, connecting using a converter is required. The converter is made with the bundled cable when using Renesas on-chip debugging emulator.

1. Connect the conversion connector to J12 on the board.
2. Connect the Renesas on-chip debugging emulator to the conversion connector.
3. Connect the emulator to the USB port of the PC.

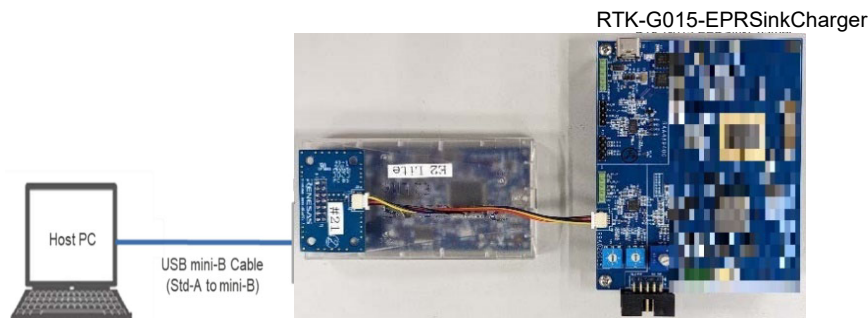

Figure 16. Board Connection for Programming by On-Chip Debugging Emulator

4. Execute the Renesas Flash Programmer V3.xx.
5. Create a New Project.

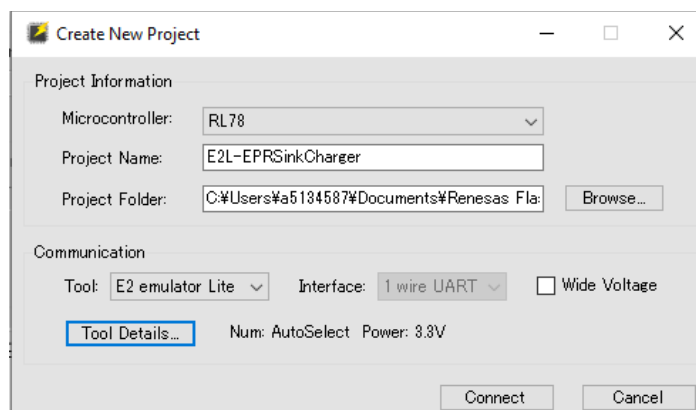

Figure 17. Create New Project Window

6. Select the **RL78** in the **Microcontroller** drop-down list, input an arbitrary name in the **Project Name** field.
7. Select your on-chip debugging emulator product in the **Tool** drop-down list.
8. Click the **Tool detail** and select the **3.3V** in the **Power Supply** area, then click **Connect**.

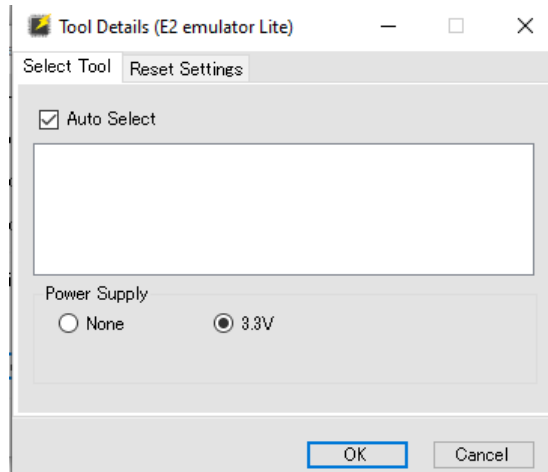

Figure 18. Tool Details Window

9. The following window appears if the new project is created correctly.

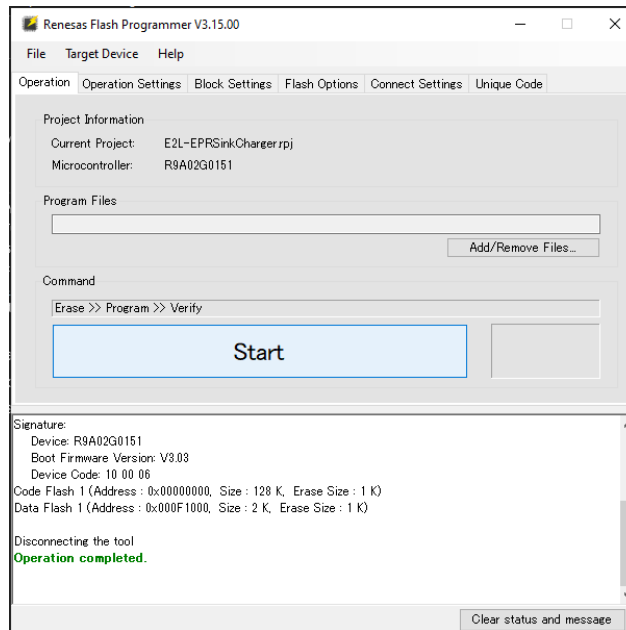

Figure 19. Project Information Window

Note: Confirm that the Microcontroller can detect R9A02G0151.

10. Select the **Erase, Program, and Verify** in the **Operation Settings** tab.

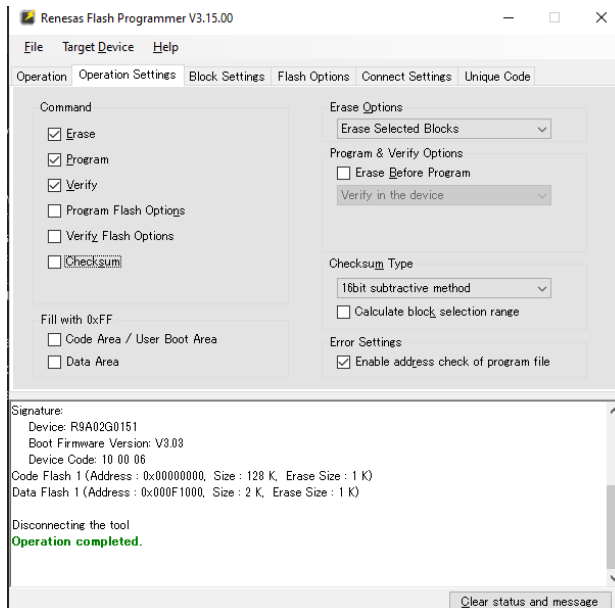

Figure 20. Operation Settings Tab

11. Click **Start** to start programming the flash memory data

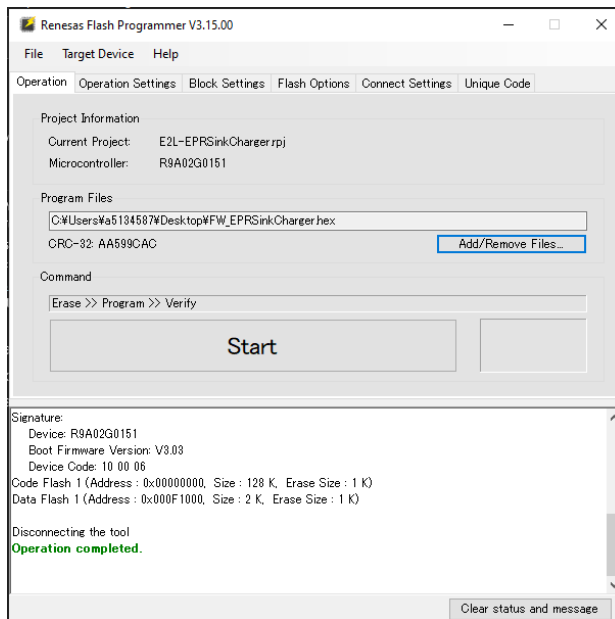

Figure 21. Operation Tab - Start Programming

12. **OK** is indicated if the program is completed successfully.

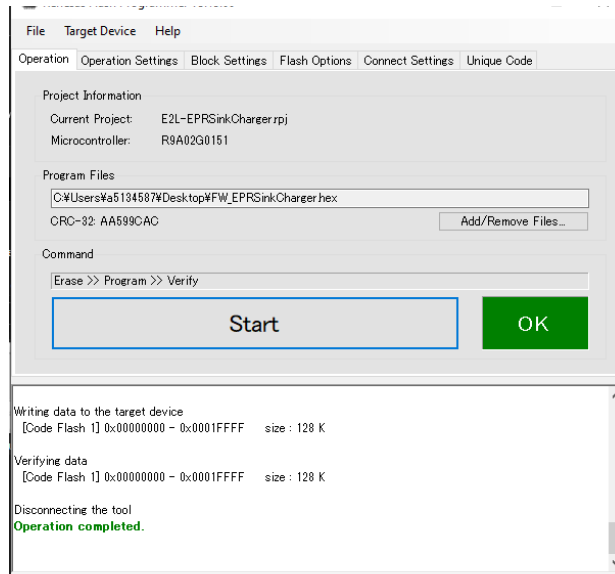

Figure 22. Successful Program Indicator

4. Optional Features

4.1 Supports USB Peripheral Function

RTK-G015-EPRSinkCharger is designed for Sink only (SNK) Charger / Power Bank turnkey solution. There is no USB data communication feature on this board. It has an interface to expand the test/debug of USB2.0-based peripheral function with system.

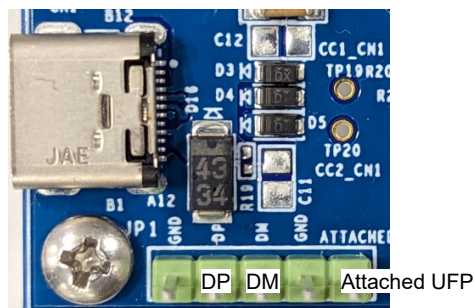

Figure 23. Connector for USB2.0-Based Peripheral Debugging

To debug a USB2.0 peripheral on RTK-G015-EPRSinkCharger, if there is a jumper between DP and DM of JP1, remove it and connect D+/D- signaling of the system to DP/DM of JP1. Since V_{BUS} appears 0V~28V (maximum), the signal pin Attached UFP is allocated on JP1 to detect attach/detach on Type-C. The system can detect Type-C attach/detach by using this signal.

4.2 Supports SMBus Target Interface

RTK-G015-EPRSinkCharger has a SMBus Target Interface to communicate with other controllers outside of this board. It is an interface to expand the feature with a total system.

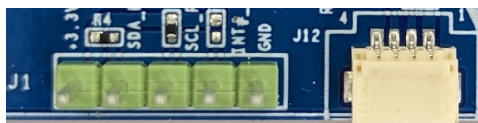

Figure 24. Connector for SMBus Target Interface

To control the RTK-G015-EPRSinkCharger board using an external controller through the SMBus Target Interface, connect the SMBus Controller signaling of the system J1. When the system wants to control RTK-G015-EPRSinkCharger, contact Renesas for support.

5. Ordering Information

Part Number	Description
RTKA489EPRDE0010BU	RTK-G015-EPRSinkCharger (Up to 28V/140W USB Type-C input)

6. Revision History

Revision	Date	Description
1.00	Nov 13, 2024	Initial release.

General Precautions in the Handling of Microprocessing Unit and Microcontroller Unit Products

The following usage notes are applicable to all Microprocessing unit and Microcontroller unit products from Renesas. For detailed usage notes on the products covered by this document, refer to the relevant sections of the document as well as any technical updates that have been issued for the products.

1. Precaution against Electrostatic Discharge (ESD)

A strong electrical field, when exposed to a CMOS device, can cause destruction of the gate oxide and ultimately degrade the device operation. Steps must be taken to stop the generation of static electricity as much as possible, and quickly dissipate it when it occurs. Environmental control must be adequate. When it is dry, a humidifier should be used. This is recommended to avoid using insulators that can easily build up static electricity.

Semiconductor devices must be stored and transported in an anti-static container, static shielding bag or conductive material. All test and measurement tools including work benches and floors must be grounded. The operator must also be grounded using a wrist strap. Semiconductor devices must not be touched with bare hands. Similar precautions must be taken for printed circuit boards with mounted semiconductor devices.

2. Processing at power-on

The state of the product is undefined at the time when power is supplied. The states of internal circuits in the LSI are indeterminate and the states of register settings and pins are undefined at the time when power is supplied. In a finished product where the reset signal is applied to the external reset pin, the states of pins are not guaranteed from the time when power is supplied until the reset process is completed. In a similar way, the states of pins in a product that is reset by an on-chip power-on reset function are not guaranteed from the time when power is supplied until the power reaches the level at which resetting is specified.

3. Input of signal during power-off state

Do not input signals or an I/O pull-up power supply while the device is powered off. The current injection that results from input of such a signal or I/O pull-up power supply may cause malfunction and the abnormal current that passes in the device at this time may cause degradation of internal elements. Follow the guideline for input signal during power-off state as described in your product documentation.

4. Handling of unused pins

Handle unused pins in accordance with the directions given under handling of unused pins in the manual. The input pins of CMOS products are generally in the high-impedance state. In operation with an unused pin in the open-circuit state, extra electromagnetic noise is induced in the vicinity of the LSI, an associated shoot-through current flows internally, and malfunctions occur due to the false recognition of the pin state as an input signal become possible.

5. Clock signals

After applying a reset, only release the reset line after the operating clock signal becomes stable. When switching the clock signal during program execution, wait until the target clock signal is stabilized. When the clock signal is generated with an external resonator or from an external oscillator during a reset, ensure that the reset line is only released after full stabilization of the clock signal. Additionally, when switching to a clock signal produced with an external resonator or by an external oscillator while program execution is in progress, wait until the target clock signal is stable.

6. Voltage application waveform at input pin

Waveform distortion due to input noise or a reflected wave may cause malfunction. If the input of the CMOS device stays in the area between V_{IL} (Max.) and V_{IH} (Min.) due to noise, for example, the device may malfunction. Take care to prevent chattering noise from entering the device when the input level is fixed, and also in the transition period when the input level passes through the area between V_{IL} (Max.) and V_{IH} (Min.).

7. Prohibition of access to reserved addresses

Access to reserved addresses is prohibited. The reserved addresses are provided for possible future expansion of functions. Do not access these addresses as the correct operation of the LSI is not guaranteed.

8. Differences between products

Before changing from one product to another, for example to a product with a different part number, confirm that the change will not lead to problems. The characteristics of a microprocessing unit or microcontroller unit products in the same group but having a different part number might differ in terms of internal memory capacity, layout pattern, and other factors, which can affect the ranges of electrical characteristics, such as characteristic values, operating margins, immunity to noise, and amount of radiated noise. When changing to a product with a different part number, implement a system-evaluation test for the given product.

Notice

1. Descriptions of circuits, software and other related information in this document are provided only to illustrate the operation of semiconductor products and application examples. You are fully responsible for the incorporation or any other use of the circuits, software, and information in the design of your product or system. Renesas Electronics disclaims any and all liability for any losses and damages incurred by you or third parties arising from the use of these circuits, software, or information.
2. Renesas Electronics hereby expressly disclaims any warranties against and liability for infringement or any other claims involving patents, copyrights, or other intellectual property rights of third parties, by or arising from the use of Renesas Electronics products or technical information described in this document, including but not limited to, the product data, drawings, charts, programs, algorithms, and application examples.
3. No license, express, implied or otherwise, is granted hereby under any patents, copyrights or other intellectual property rights of Renesas Electronics or others.
4. You shall be responsible for determining what licenses are required from any third parties, and obtaining such licenses for the lawful import, export, manufacture, sales, utilization, distribution or other disposal of any products incorporating Renesas Electronics products, if required.
5. You shall not alter, modify, copy, or reverse engineer any Renesas Electronics product, whether in whole or in part. Renesas Electronics disclaims any and all liability for any losses or damages incurred by you or third parties arising from such alteration, modification, copying or reverse engineering.
6. Renesas Electronics products are classified according to the following two quality grades: "Standard" and "High Quality". The intended applications for each Renesas Electronics product depends on the product's quality grade, as indicated below.

"Standard": Computers; office equipment; communications equipment; test and measurement equipment; audio and visual equipment; home electronic appliances; machine tools; personal electronic equipment; industrial robots; etc.

"High Quality": Transportation equipment (automobiles, trains, ships, etc.); traffic control (traffic lights); large-scale communication equipment; key financial terminal systems; safety control equipment; etc.

Unless expressly designated as a high reliability product or a product for harsh environments in a Renesas Electronics data sheet or other Renesas Electronics document, Renesas Electronics products are not intended or authorized for use in products or systems that may pose a direct threat to human life or bodily injury (artificial life support devices or systems; surgical implantations; etc.), or may cause serious property damage (space system; undersea repeaters; nuclear power control systems; aircraft control systems; key plant systems; military equipment; etc.). Renesas Electronics disclaims any and all liability for any damages or losses incurred by you or any third parties arising from the use of any Renesas Electronics product that is inconsistent with any Renesas Electronics data sheet, user's manual or other Renesas Electronics document.
7. No semiconductor product is absolutely secure. Notwithstanding any security measures or features that may be implemented in Renesas Electronics hardware or software products, Renesas Electronics shall have absolutely no liability arising out of any vulnerability or security breach, including but not limited to any unauthorized access to or use of a Renesas Electronics product or a system that uses a Renesas Electronics product. RENESAS ELECTRONICS DOES NOT WARRANT OR GUARANTEE THAT RENESAS ELECTRONICS PRODUCTS, OR ANY SYSTEMS CREATED USING RENESAS ELECTRONICS PRODUCTS WILL BE INVULNERABLE OR FREE FROM CORRUPTION, ATTACK, VIRUSES, INTERFERENCE, HACKING, DATA LOSS OR THEFT, OR OTHER SECURITY INTRUSION ("Vulnerability Issues"). RENESAS ELECTRONICS DISCLAIMS ANY AND ALL RESPONSIBILITY OR LIABILITY ARISING FROM OR RELATED TO ANY VULNERABILITY ISSUES. FURTHERMORE, TO THE EXTENT PERMITTED BY APPLICABLE LAW, RENESAS ELECTRONICS DISCLAIMS ANY AND ALL WARRANTIES, EXPRESS OR IMPLIED, WITH RESPECT TO THIS DOCUMENT AND ANY RELATED OR ACCOMPANYING SOFTWARE OR HARDWARE, INCLUDING BUT NOT LIMITED TO THE IMPLIED WARRANTIES OF MERCHANTABILITY, OR FITNESS FOR A PARTICULAR PURPOSE.
8. When using Renesas Electronics products, refer to the latest product information (data sheets, user's manuals, application notes, "General Notes for Handling and Using Semiconductor Devices" in the reliability handbook, etc.), and ensure that usage conditions are within the ranges specified by Renesas Electronics with respect to maximum ratings, operating power supply voltage range, heat dissipation characteristics, installation, etc. Renesas Electronics disclaims any and all liability for any malfunctions, failure or accident arising out of the use of Renesas Electronics products outside of such specified ranges.
9. Although Renesas Electronics endeavors to improve the quality and reliability of Renesas Electronics products, semiconductor products have specific characteristics, such as the occurrence of failure at a certain rate and malfunctions under certain use conditions. Unless designated as a high reliability product or a product for harsh environments in a Renesas Electronics data sheet or other Renesas Electronics document, Renesas Electronics products are not subject to radiation resistance design. You are responsible for implementing safety measures to guard against the possibility of bodily injury, injury or damage caused by fire, and/or danger to the public in the event of a failure or malfunction of Renesas Electronics products, such as safety design for hardware and software, including but not limited to redundancy, fire control and malfunction prevention, appropriate treatment for aging degradation or any other appropriate measures. Because the evaluation of microcomputer software alone is very difficult and impractical, you are responsible for evaluating the safety of the final products or systems manufactured by you.
10. Please contact a Renesas Electronics sales office for details as to environmental matters such as the environmental compatibility of each Renesas Electronics product. You are responsible for carefully and sufficiently investigating applicable laws and regulations that regulate the inclusion or use of controlled substances, including without limitation, the EU RoHS Directive, and using Renesas Electronics products in compliance with all these applicable laws and regulations. Renesas Electronics disclaims any and all liability for damages or losses occurring as a result of your noncompliance with applicable laws and regulations.
11. Renesas Electronics products and technologies shall not be used for or incorporated into any products or systems whose manufacture, use, or sale is prohibited under any applicable domestic or foreign laws or regulations. You shall comply with any applicable export control laws and regulations promulgated and administered by the governments of any countries asserting jurisdiction over the parties or transactions.
12. It is the responsibility of the buyer or distributor of Renesas Electronics products, or any other party who distributes, disposes of, or otherwise sells or transfers the product to a third party, to notify such third party in advance of the contents and conditions set forth in this document.
13. This document shall not be reprinted, reproduced or duplicated in any form, in whole or in part, without prior written consent of Renesas Electronics.
14. Please contact a Renesas Electronics sales office if you have any questions regarding the information contained in this document or Renesas Electronics products.

(Note1) "Renesas Electronics" as used in this document means Renesas Electronics Corporation and also includes its directly or indirectly controlled subsidiaries.

(Note2) "Renesas Electronics product(s)" means any product developed or manufactured by or for Renesas Electronics.

(Disclaimer Rev.5.0-1 October 2020)

Corporate Headquarters

TOYOSU FORESIA, 3-2-24 Toyosu,
Koto-ku, Tokyo 135-0061, Japan
www.renesas.com

Trademarks

Renesas and the Renesas logo are trademarks of Renesas Electronics Corporation. All trademarks and registered trademarks are the property of their respective owners.

Contact Information

For further information on a product, technology, the most up-to-date version of a document, or your nearest sales office, please visit:
www.renesas.com/contact/