

# RX72T CPU Card User's Manual

R12UZ0031EJ0110  
Rev.1.10  
2022.2.21

## For Your Safety



Do not fail to read this manual before using the RX72T CPU card (RTK0EMX990C00000BJ) (the product).

- Follow the indications in this manual when using the product.
- This product is an optional board for "Evaluation System for BLDC Motor (RTK0EMX270S00020BJ)" and "24V Motor Control Evaluation System for RX23T (RTK0EM0006S01212BJ)". Transfer or sale of the product to third parties is prohibited without written approval.
- The purchaser or importer of the product is responsible for ensuring compliance with local regulations. In addition, the customer is responsible for ensuring that the product is handled correctly and safely, in accordance with the laws of the customer's country (region).
- All information contained in this manual represents information on products at the time of publication of this manual. Please note that the product data, specification, sales offices, contents of website, address, etc., are subject to change by Renesas Electronics Corporation without notice due to product improvements or other reasons. Please confirm the latest information on Renesas Electronics website.
- The manual for the product, and specification (the documents) are the tool that was developed for the function and performance evaluation of Renesas Electronics semiconductor device (Renesas Electronics device) mounted on the product, and not guarantee the same quality, function and performance.
- By purchasing the product or downloading the documents from Renesas Electronics website, the support services provided from Renesas Electronics is not guaranteed.

## Meaning of Notations

In this manual items related to the safe use of the product are indicated as described below.

The degree of injury to persons or damage to property that could result if the designated content in this manual is not followed is indicated as follows.

 <b>Danger</b>	Indicates content that, if not followed, could result in death or serious injury* <sup>1</sup> to the user, and which is highly urgent.
 <b>Warning</b>	Indicates content that, if not followed, could result in death or serious injury to the user.
 <b>Caution</b>	Indicates content that, if not followed, could result in injury* <sup>2</sup> to persons or physical damage.* <sup>3</sup>

Note 1. Serious injury refers to conditions resulting in persistent after-effects and for which treatment would necessitate hospitalization or regular hospital visits, such as loss or impairment of eyesight, burns (high- or low-temperature), electric shock, bone fracture, or poisoning.

Note 2. Injury refers to conditions for which treatment would necessitate hospitalization or regular hospital visits.

Note 3. Physical damage refers to damage affecting the wider surroundings, such as the user's home or property.

Requirements related to the handling of the product are classified into the following categories.



- Marks indicating that an action is prohibited.

	<p><b>General Prohibition</b> The indicated action is prohibited.</p>		<p>Example: Do Not Touch! Touching the specified location could result in injury.</p>
---	---	---	---

- Marks indicating that an action is prohibited.





	<p><b>General Caution</b> Indicates a general need for caution that is not specified.</p>		<p>Example: Caution – Hot! Indicates the possibility of injury due to high temperature.</p>
---	---	---	---

- Marks directing that the specified action is required.







	<p><b>General Instruction</b> The specified action is required.</p>		<p>Example: Turn Off (Disconnect) Power Supply! Instructs the user to turn off (disconnect) the power supply to the product.</p>
---	---	---	--

## Warnings Regarding Use of the Product





### ■ Danger Items

 <b>Danger</b>	
  	<ul style="list-style-type: none"> <li>The product should be used only by persons (users) having a thorough knowledge of electrical and mechanical components and systems, a full knowledge of the risks associated with handling them, and training in inverter motor control and handling motors, or equivalent skills. Users should be limited to persons who have carefully read the Caution Items contained in this manual.</li> <li>Unlike typical equipment, the product has no protective case to ensure safety, and it contains moving parts and high-temperature components that could be dangerous. Do not touch the evaluation board or cables while power is being supplied.</li> <li>Carefully check to make sure that there are no pieces of conductive materials or dust adhering to the board, connectors, and cables.</li> <li>There are moving parts, driven by a motor. Do not touch the motor while power is being supplied.</li> <li>Ensure that the motor is insulated and placed in a stable location before supplying power.</li> </ul>
	<p><b>Do Not Connect Load to Motor!</b></p> <ul style="list-style-type: none"> <li>This could cause fire, burns, or injury.</li> </ul>

■ Warning Items

 <b>Warning</b>	
	<p>Caution – Rotating Parts!</p> <ul style="list-style-type: none"> <li>The system includes a motor. Touching the rotating shaft could cause high-temperature burns or injury.</li> </ul>
	<p>Always insert plugs, connectors, and cables securely, and confirm that they are fully inserted.</p> <ul style="list-style-type: none"> <li>Incomplete connections could cause fire, burns, electric shock, or injury.</li> </ul>
	<p>Use the power supply apparatus specified in the manual.</p> <ul style="list-style-type: none"> <li>Failure to do so could cause fire, burns, electric shock, injury, or malfunction.</li> </ul>
	<p>Disconnect the power supply and unplug all cables when the system will not be used for a period of time or when moving the system.</p> <ul style="list-style-type: none"> <li>Failure to do so could cause fire, burns, electric shock, or malfunction.</li> <li>This will protect the system against damage due to lightning.</li> </ul>
	<p>Use a mechanism (switch, outlet, etc.) located within reach to turn off (disconnect) the power supply.</p> <ul style="list-style-type: none"> <li>In case of emergency, it may be necessary to cut off the power supply quickly.</li> </ul>
	<p>Turn off the power supply immediately if you notice abnormal odor, smoke, abnormal sound, or overheating.</p> <ul style="list-style-type: none"> <li>Continuing to use the system in an abnormal condition could cause fire, burns, or electric shock.</li> </ul>
	<p>Do Not Disassemble, Modify, or Repair!</p> <ul style="list-style-type: none"> <li>Doing so could cause fire, burns, electric shock, injury, or malfunction.</li> </ul>
	<p><b>Do not use the product for any purpose other than initial evaluation of motor control in a testing room or lab. Do not integrate the product or any part of it into other equipment. Do not insert or remove cables or connectors when the product is powered on.</b></p> <ul style="list-style-type: none"> <li>The product has no safety case.</li> <li>Failure to observe the above could cause fire, electric shock, burns, or malfunction.</li> <li>The product may not perform as expected if used for other than its intended purpose.</li> </ul>

■ Caution Items

 <b>Caution</b>	
	<p>Caution – Hot!</p> <ul style="list-style-type: none"> <li>The motor gets hot. Touching it could cause high-temperature burns.</li> </ul>
	<p>Follow the procedure specified in the manual when powering the system on or off.</p> <ul style="list-style-type: none"> <li>Failure to do so could cause overheating or malfunction.</li> </ul>
	<p>Caution – Static Electricity</p> <ul style="list-style-type: none"> <li>Use the antistatic band. Failure to do so could cause malfunction or unstable motion.</li> </ul>

## Overview

The RX72T CPU card (RTK0EMX990C00000BJ) is an optional board for the Evaluation System for BLDC Motor (RTK0EMX270S00020BJ) and the 24V Motor Control Evaluation System for RX23T (RTK0EM0006S01212BJ). By connecting this product to an inverter board (the INV-BRD), motor evaluation using RX72T becomes possible.

An emulator, INV-BRD, and equipment must be provided by the customer.

This user's manual describes the proper handling of the product.

## Target Device

RX72T microcontroller

## Related Documents

- RX72T CPU Card Schematic : R12TU0057EJ
- RX72T CPU Card BOM List : R12TU0058EJ
- RX72T CPU Card PWB Pattern Drawing : R12TU0059EJ
- Evaluation System for BLDC Motor User's Manual: R12UZ0062  
24V Motor Control Evaluation System for RX23T User's Manual: R20UT3697EJ

## Package Contents

- RX72T CPU Card Information
- Caution regarding the Motor Control Evaluation Board – RX72T CPU Card -

## Abbreviations

Abbreviations	Full Name	Remarks
INV-BRD	Inverter Board	Inverter board included in "Evaluation System for BLDC Motor" (Board P/N.: RTK0EM0000B10020BJ) or Inverter board included in "24V Motor Control Evaluation System for RX23T" (Board P/N.: RTK0EM0001B00012BJ)
E1	E1 emulator	on-chip debugging emulator and flash programmer Product No.: R0E000010KCE00
E2 Lite	E2 emulator Lite	on-chip debugging emulator and flash programmer Product No.: RTE0T0002LKCE00000R

## Contents

<b>1. Specifications</b> .....	<b>6</b>
1.1 Specification.....	6
1.2 Regulatory Compliance Notices.....	7
1.2.1 European Union regulatory notices.....	7
<b>2. Block Diagram</b> .....	<b>8</b>
<b>3. Layout</b> .....	<b>9</b>
<b>4. Usage</b> .....	<b>10</b>
<b>5. Functions</b> .....	<b>11</b>
5.1 Power Supply.....	11
5.2 Connecting the Emulator .....	11
5.3 Connecting the Inverter Board .....	12
5.4 Connecting the Serial Communication.....	13
5.5 Hall Sensor Signal Input.....	13
5.6 Encoder Signal Input .....	14
5.7 Connecting the Extender Board .....	15
5.8 Extension of Unused Pins.....	16
5.9 Reset Circuit .....	17
5.10 Crystal Resonator .....	17
5.11 LEDs .....	17
5.12 JP1, JP2.....	17
<b>6. Details of RX72T CPU Card</b> .....	<b>18</b>
6.1 RX72T Features .....	18
6.2 RX72T Pin Assignments.....	19
6.3 List of RX72T Pin Functions .....	20
<b>7. Caution Items</b> .....	<b>25</b>
<b>Revision History</b> .....	<b>27</b>

## 1. Specifications

### 1.1 Specification

Table 1-1 Overview of RX72T CPU Card Specifications

Item	Specification	
Product name	RX72T CPU card	
Board product No.	RTK0EMX990C00000BJ	
Supported inverter board / product No.	Inverter board supplied with Evaluation System for BLDC Motor / RTK0EM0000B10020BJ Supplied with 24V Motor Control Evaluation System for RX23T 24V Inverter Board / RTK0EM0001B00012BJ	
Exterior view		
Note: Appearance of actual product may differ from photo.		
MCU	Product group	RX72T group
	Product No.	R5F572TKCDFB
	CPU max. operating frequency	200 MHz
	Bit count	32 bits
	Package / Pin count	LFQFP / 144 pins
	ROM	1MB
	RAM	128KB
MCU input clock	10MHz	
Input power supply voltage	DC 5 V ( $\pm 5\%$ ) * <sup>1</sup> Selectable among the following: <ul style="list-style-type: none"> <li>• Power supply from supported inverter board</li> <li>• Power supply from supported emulator *<sup>2</sup></li> </ul>	
Supported sensors	Hall sensor, encoder (through holes provided for signal monitoring test pins)	
Supported emulator	E1, E2 Lite	
Connectors	<ul style="list-style-type: none"> <li>• Inverter board connectors x 2</li> <li>• Extender board connector x 2 (Unmounted)</li> <li>• SCI communication connectors x 3 (Two of them are unmounted)</li> <li>• CAN communication connector (Shared with SCI connector, unmounted)</li> <li>• Emulator connector</li> <li>• Hall sensor signal input connector</li> <li>• Encoder signal input connector</li> </ul>	
Switch	MCU external reset switch	
LEDs	User control LEDs x 2	
Operating temperature	Room temperature	
Operating humidity	No condensation	

Note 1. Supply voltage is DC 3.3V from E2 Lite.

Note 2. Power supply from the supported emulator is only supported for standalone operation. Power supply from the supported emulator is not supported when the INV-BRD is connected.

## 1.2 Regulatory Compliance Notices

### 1.2.1 European Union regulatory notices

This product complies with the following EU Directives. (These directives are only valid in the European Union.)

CE Certifications:

- Electromagnetic Compatibility (EMC) Directive 2014/30/EU  
EN61326-1 : 2013 Class A

---

**WARNING:** This is a Class A product. This equipment can cause radio frequency noise when used in the residential area. In such cases, the user/operator of the equipment may be required to take appropriate countermeasures under his responsibility.

---

- Information for traceability
  - Authorised representative  
Name: Renesas Electronics Corporation  
Address: Toyosu Foresia, 3-2-24, Toyosu, Koto-ku, Tokyo 135-0061, Japan
  - Manufacturer  
Name: Renesas Electronics Corporation  
Address: Toyosu Foresia, 3-2-24, Toyosu, Koto-ku, Tokyo 135-0061, Japan
  - Person responsible for placing on the market  
Name: Renesas Electronics Europe GmbH  
Address: Arcadiastrasse 10, 40472 Dusseldorf, Germany
  - Trademark and Type name  
Trademark: Renesas  
Product name: RX72T CPU Card for Motor Control  
Type name: RTK0EMX990C00000BJ

Environmental Compliance and Certifications:

- Waste Electrical and Electronic Equipment (WEEE) Directive 2012/19/EU

2. Block Diagram

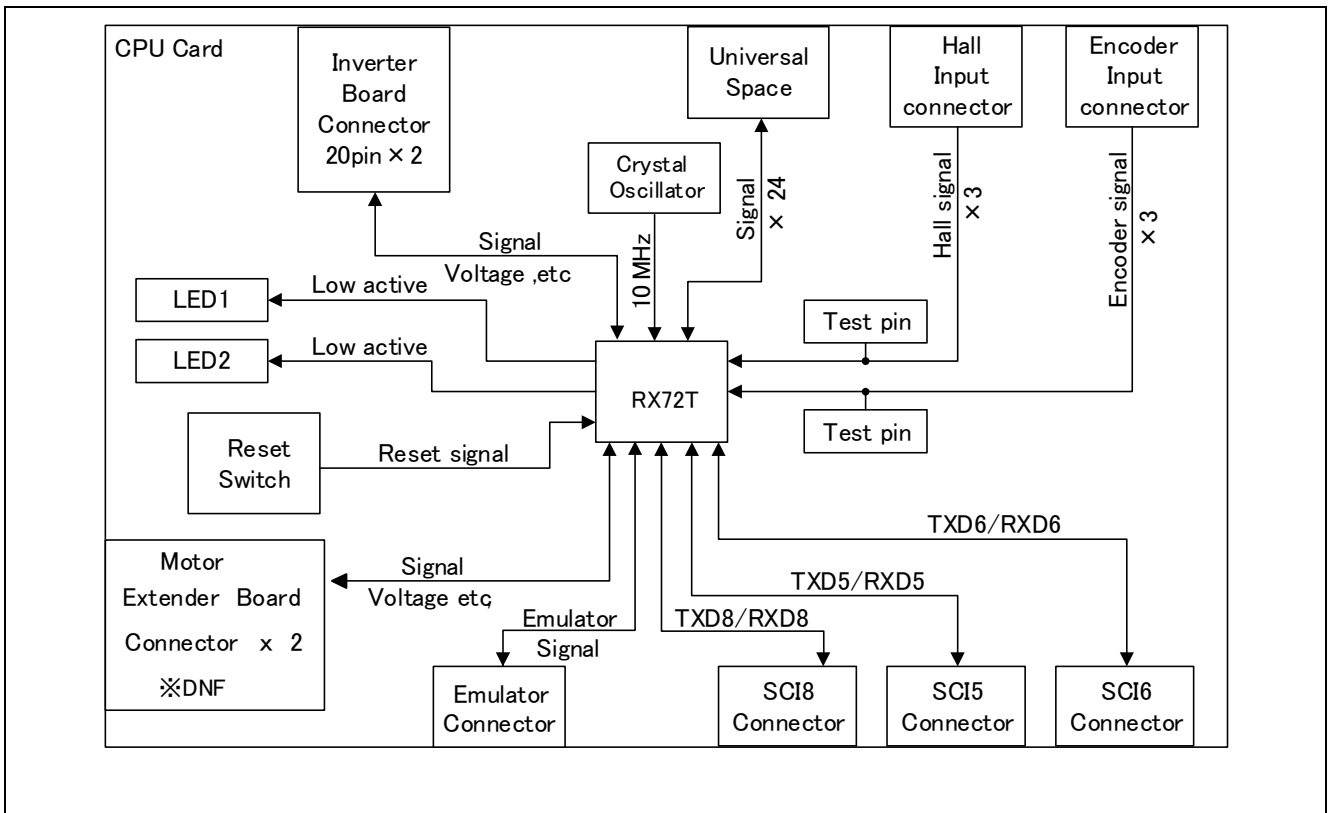

Figure 2.1 RX72T CPU Card Block Diagram



### 3. Layout

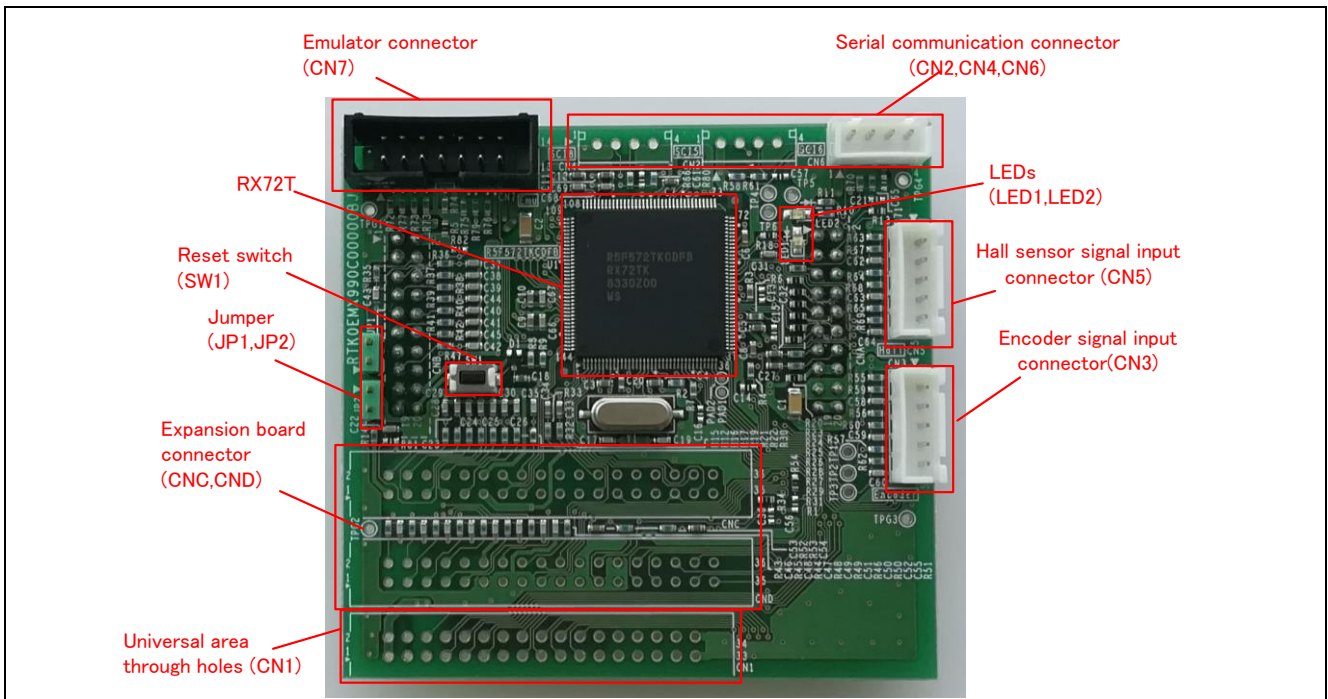

Figure 3.1 RX72T CPU Card Layout (Top View)

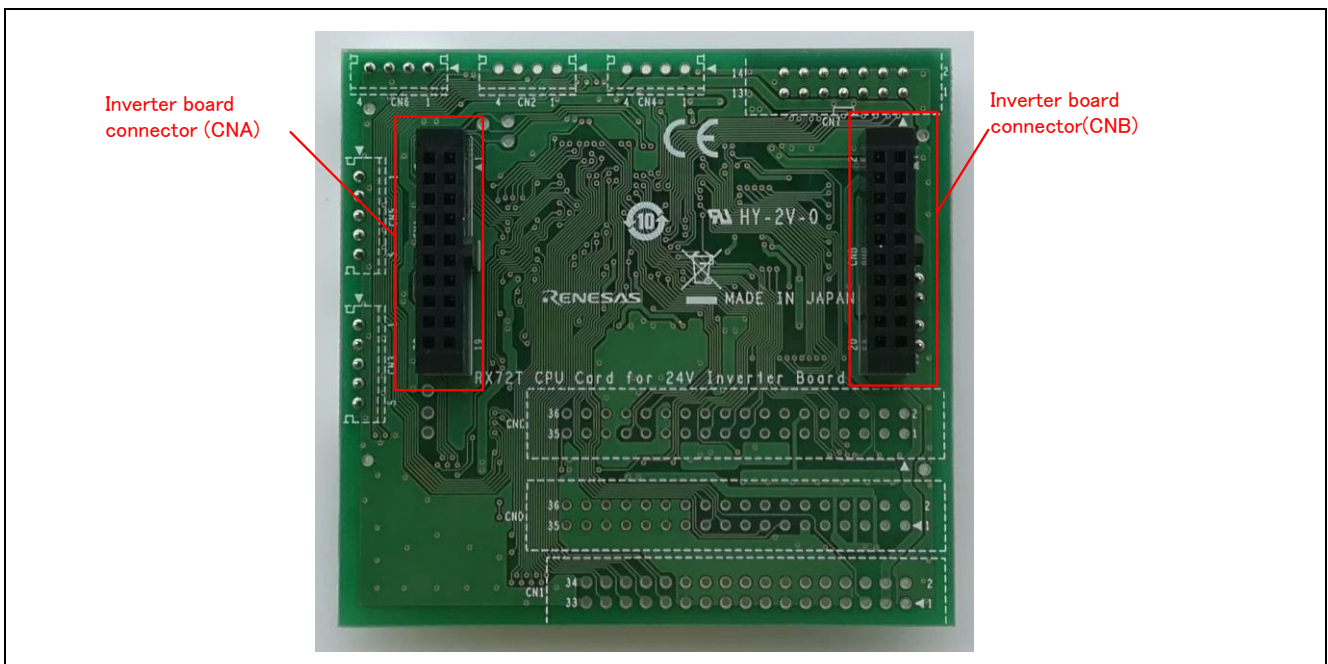

Figure 3.2 RX72T CPU Card Layout (Bottom View)

## 4. Usage

Before connecting to the INV-BRD, be sure to write the software corresponding to the INV-BRD to this product. The board may be damaged if it is connected to the INV-BRD with the factory default software or with software that is not compatible with the inverter board.

For details on writing software, please refer to 5.2. For the operation of the written software, refer to the application note of each software.

Please refer to the user's manual of each INV-BRD for the connection method with INV-BRD.

## 5. Functions

### 5.1 Power Supply

The product does not have a dedicated power supply connector. When connected to the INV-BRD it draws power via the connector. When not connected to the INV-BRD, it can draw power via the Emulator connector. The product is not allowed to draw power via the Emulator connector when it is connected to the INV-BRD.

### 5.2 Connecting the Emulator

The E1/E2 Lite on-chip debugging emulator from Renesas Electronics is used to write software (program) to the flash memory of the RX72T. Software will be downloaded into the product via E1 or E2 Lite. It is also necessary to make the settings shown in Table 5-1 in the integrated development environment or in the Renesas flash programmer to enable the emulator to supply power to the product. Table 5-2 lists the pin assignments of the Emulator connector.

**Table 5-1 E1, E2 Lite Power Supply Settings**

Connection to INV-BRD	Power Supply Setting of E1, E2 Emulator
Connected	Power supply is not allowed*1
Not connected	5.0V or 3.3V power supply

Note 1. When connected to the INV-BRD, the product must draw power from the INV-BRD.

**Table 5-2 Pin Assignments of Emulator Connector (CN7)**

Pin No.	Pin Function	RX72T Connection Pins	Pin No.	Pin Function	RX72T Connection Pins
1	TCK/FINEC	TCK/FINEC	2	GND	VSS/AVSS
3	TRST#	TRST#	4	EMLE	EMLE
5	TXD1/TDO	PD3/TDO/TXD1	6	NC	-
7	MD/FINED	MD/FINED	8	VCC	VCC
9	TMS	TMS	10	UB	UB
11	TDI/RXD1	PD5/TDI/RXD1	12	GND	VSS/AVSS
13	RESET#	RES#	14	GND	VSS/AVSS

Note: See a supplement to the E1/E20/E2 emulator, E2 emulator Lite user's manual.

### 5.3 Connecting the Inverter Board

The product connects to the INV-BRD via the inverter board connectors (CNA and CNB). Table 5-3 and Table 5-4 list the pin assignments of the inverter board connectors.

**Table 5-3 Pin Assignments of Inverter Board Connector (CNA)**

Pin No.	Pin Function	RX72T Connection Pins	Pin No.	Pin Function	RX72T Connection Pins
1	LED1#_1	PC5	2	LED2#_1	PC6
3	LED3#_1	P34	4	NC	PA1(unused)
5	FO#	P70/POE0#	6	NC	—
7	WN	P76/MTIOC4D	8	VN_1	P75/MTIOC4C
9	UN	P74/MTIOC3D	10	WP_1	P73/MTIOC4B
11	VP	P72/MTIOC4A	12	UP_1	P71/MTIOC3B
13	SW1#_1	P35	14	SW2#_1	PA0
15	5V	VCC	16	5V	VCC
17	GND	VSS	18	GND	VSS
19	3.3V	—	20	3.3V	—

**Table 5-4 Pin Assignments of Inverter Board Connector (CNB)**

Pin No.	Pin Function	RX72T Connection Pins	Pin No.	Pin Function	RX72T Connection Pins
1	AVCC	AVCC	2	AVCC	AVCC
3	NC	—	4	PGAVSS_1	PGAVSS0
5	IU_1	P40/AN000	6	IV_1	P41/AN001
7	IW_1	P42/AN002	8	VPN_1	P63/AN209
9	TEMP_1	—	10	VU_1	P60/AN206
11	VV_1	P61/AN207	12	VW_1	P62/AN208
13	VAC_1	—	14	IPFC_1	—
15	VR_1	P43/AN003	16	VN_1	—
17	VCCIO	VCC	18	VCCIO	VCC
19	GND	VSS	20	GND	VSS

## 5.4 Connecting the Serial Communication

The product communicates with the UART via the serial communication connectors. There are three serial communication connectors: CN2, CN4, and CN6. Table 5-5 lists their pin assignments. Use CN6 when using a tool such as waveform display in conjunction with the INV-BRD.

**Table 5-5 Pin Assignments of Serial Communication Connectors (CN2, CN4, CN6)**

Connector No.	Pin No.	Pin Function	RX72T Connection Pins
CN2	1	5V	VCC
SCI5 (DNF)	2	RX72T transmit side	PB5/TXD5/CTX0
	3	RX72T receive side	PB6/RXD5/CRX0
	4	GND	VSS
CN4	1	5V	VCC
SCI8 (DNF)	2	RX72T transmit side	PC1/ TXD8
	3	RX72T receive side	PC0/ RXD8
	4	GND	VSS
CN6	1	5V	VCC
SCI6	2	RX72T transmit side	PB0/TXD6
	3	RX72T receive side	PB1/RXD6
	4	GND	VSS

## 5.5 Hall Sensor Signal Input

The product is equipped with a Hall sensor signal input connector. The signal input to the product is pulled up to 5 V and passed through an RC filter before being input to the RX72T. Table 5-6 lists the pin assignments of the Hall sensor signal input connector, and Table 5-7 lists connector information.

**Table 5-6 Pin Assignments of Hall Sensor Signal Input Connector (CN5)**

Pin No.	Pin Function	RX72T Connection Pins
1	5V	VCC
2	GND	VSS
3	HALL_U_1	P23/IRQ11
4	HALL_V_1	P24/IRQ4
5	HALL_W_1	P25/IRQ10

**Table 5-7 Hall Sensor Signal Input Connector Information**

Part	Product No.	Manufacturer
Connector (CN5)	B5B-XH-A	J.S.T. Mfg. Co. Ltd.

## 5.6 Encoder Signal Input

The product is equipped with an encoder signal input connector. This makes it possible to input the encoder signal to the RX72T. The signal input to the product is pulled up to 5 V and passed through an RC filter before being input to the RX72T. Table 5-8 lists the pin assignments of the signal input connector, and Table 5-9 lists connector information.

**Table 5-8 Pin Assignments of Encoder Signal Input Connector (CN3)**

Pin No.	Pin Function	RX72T Connection Pins
1	5V	VCC
2	GND	VSS
3	ENC_A_1	PA7
4	ENC_B_1	PA6
5	ENC_Z_1	PA5

**Table 5-9 Encoder Signal Input Connector Information**

Part	Product No.	Manufacturer
Connector (CN3)	B5B-XH-A	J.S.T. Mfg. Co. Ltd.

## 5.7 Connecting the Extender Board

This product is equipped with two Extender board Connector. This connector can connect Extender Board (RTK0EM0000Z02000BJ) via the cable. This makes it possible to control three INV-BRDs. In other words, this product can drive three motors. Table 5-10 lists the pin assignments of the 2nd Extender board Connector.

Table 5-11 lists the pin assignments of the 3rd Extender board Connector. Note that the pin assignments of CND are different from those of CNC and that some pins of CND are pull-upped because of sharing the pins with CN7.

**Table 5-10 Pin Assignments of 2nd Extender boards Connector**

CNC Pin No.	CNC Pin Function	RX72T Connection Pins	CNC Pin No.	CNC Pin Function	RX72T Connection Pins
1	PGAVSS_2	PGAVSS1	2	VPN_2	P55/AN203
3	IU_2	P44/AN100	4	IV_2	P45/AN101
5	IW_2	P46/AN102	6	TEMP_2	—
7	VU_2	P52/AN200	8	VV_2	P53/AN201
9	VW_2	P54/AN202	10	VR_2	—
11	GND	VSS	12	GND	AVSS
13	LED1#_2	P15	14	LED2#_2	P16
15	LED3#_2	P17	16	FO#_2	P01/POE12#
17	WN_2	P90/MTIOC7D	18	VN_2	P91/MTIOC7C
19	UN_2	P92/MTIOC6D	20	WP_2	P93/MTIOC7B
21	VP_2	P94/MTIOC7A	22	UP_2	P95/MTIOC6B
23	SW1#_2	P13	24	SW2#_2	P14
25	GND	VSS	26	GND	VSS
27	ENC_A_2	P31/MTCLKC	28	ENC_B_2	P30/MTCLKD
29	ENC_Z_2	PA3/MTIOC2A	30	GND	VSS
31	GND	VSS	32	HALL_U_2	PE5/IRQ0
33	HALL_V_2	PE6/IRQ3	34	HALL_W_2	P12/IRQ9
35	VRL_2	P10(DNF)	36	NC	—

**Table 5-11 Pin Assignments of 3rd Extender boards Connector**

CND Pin No.	CND Pin Function	RX72T Connection Pins	CND Pin No.	CND Pin Function	RX72T Connection Pins
1	PGAVSS_3	—	2	VPN_3	PH2/AN005
3	IU_3	PH1/AN004	4	IV_3	P47/AN103
5	IW_3	P50/AN204	6	TEMP_3	—
7	VU_3	PH5/AN104	8	VV_3	PH6/AN105
9	VW_3	PH7/AN106	10	VR_3	—
11	GND	VSS	12	GND	AVSS
13	LED1#_3	PF3	14	LED2#_3	PE3
15	LED3#_3	PB7	16	FO#_3	PE4/POE10#
17	WN_3	PK1/GTIOC2B	18	VN_3	PG0/GTIOC1B
19	UN_3	PG2/GTIOC0B	20	WP_3	PK0/GTIOC2A
21	VP_3	PK2/GTIOC1A	22	UP_3	PG1/GTIOC0A
23	SW1#_3	PE0	24	SW2#_3	PE1
25	GND	VSS	26	GND	VSS
27	ENC_A_3	PD1/GTIOC3A	28	ENC_B_3	PD0/GTIOC3B
29	ENC_Z_3	PB4/GTETRGA	30	GND	VSS
31	GND	VSS	32	HALL_U_3	PF0/IRQ12
33	HALL_V_3	PF1/IRQ13	34	HALL_W_3	PF2/IRQ5
36	VRL_3	PD2(DNF)	36	NC	—

## 5.8 Extension of Unused Pins

To facilitate general use of the product, the unused pins of the RX72T are extended through universal connector through holes in the board. Table 5-12 lists the pin assignments of the universal area through holes.

**Table 5-12 Pin Assignments of Universal Area Through Holes (CN1)**

Pin No.	RX72T Connection Pins	Pin No.	RX72T Connection Pins
1	UVCC	2	UVCC
3	AVCC	4	AVCC
5	PE2	6	PC2
7	PB3	8	PB2
9	PA4	10	PA2
11	P96	12	P33
13	VSS	14	VSS
15	P32	16	P27
17	P26	18	P22
19	PC4	20	PC3
21	P21	22	P20
23	VSS	24	VSS
25	P65	26	P64
27	P51	28	PH3
29	P82	30	P81
31	P80	32	P11
33	VSS	34	VSS



## 5.9 Reset Circuit

The product is equipped with a reset circuit for resetting the microcontroller at power-on reset and external reset. To apply an external reset to the microcontroller, press the pushbutton (SW1).

## 5.10 Crystal Resonator

This product is mounted crystal oscillator (Y1) on 8MHz.

## 5.11 LEDs

Two LEDs are mounted on the product for use in debugging programs and general system applications. Each turns on when the output on the corresponding port is low-level and turns off when the output is high-level. Table 5-13 lists the pin assignments corresponding to the LEDs.

**Table 5-13 RX72T CPU Card LED Connection Pin Assignments**

Corresponding RX72T Port		LED1	LED2
PC5	High-level output	Off	-
	Low-level output	On	-
PC6	High-level output	-	Off
	Low-level output	-	On

## 5.12 JP1, JP2

JP1 and JP2 should be short-circuited between 2-3Pin.

**Table 5-14 Jumper JP1 and JP2 configuration**

JP1, JP2 configuration	Function	
	JP1	JP2
Open	Connect MCU (PGAVSS0 pin) to CNB (4 pin)	Connect MCU (PGAVSS1 pin) to CNC (1 pin)
<b>Short (Factory settings)</b>	Connect MCU (PGAVSS0 pin) to GND	Connect MCU (PGAVSS1 pin) to GND

## 6. Details of RX72T CPU Card

### 6.1 RX72T Features

1. 32-bit microcontroller with RXv3 CPU core for motor control
2. On-chip 32-bit single-precision floating point unit (FPU)
3. Ability to output three-phase complementary PWM waveforms on three channels
4. Ability to set timer interrupt as A/D trigger
5. Three 12-bit A/D converter units with a total of 33 channels
6. Channel-dedicated sample and hold function
7. On-chip programmable gain amplifier and comparator
8. Timer output stop (Hi-Z) function
9. On-chip independent watchdog timer



### 6.3 List of RX72T Pin Functions

Table 6-1 List of RX72T Pin Functions (1/5)

Pin No.	RX72T Pin Functions	CPU Card Connection	External Connection (N.C. : No connection)
1	P14/MTIOC4B/MTIOC4B#/GTIOC2A/GTIOC9A/GTIOC2A#/GTIOC9A#/IRQ11	CNC-24	SW2#_2
2	P13/MTIOC4A/MTIOC4A#/GTIOC1A/GTIOC8A/GTIOC1A#/GTIOC8A#/IRQ10	CNC-23	SW1#_2
3	P12/MTIOC3B/MTIOC3B#/GTIOC0A/GTIOC7A/GTIOC0A#/GTIOC7A#/IRQ9	CNC-34	HALL_W_2
4	PE6/RD#/GTETRGA/GTETRGA/GTETRGC/GTETRGD/POE10#/IRQ3	CNC-33	HALL_V_2
5	PE5/BCLK/MTIOC9D/MTIOC9D#/GTIOC3A/GTETRGA/GTIOC3A#/GTETRGD/SCK9/CTS9#/RTS9#/SS9#/IRQ0/ADST0	CNC-32	HALL_U_2
6	VCC	VCC	VCC
7	EMLE	CN7-4	E1, E2 Lite
8	VSS	VSS	VSS
9	UB/P00/A11/MTIOC9A/MTIOC9A#/CACREF/RXD9/SMISO9/SSCL9/RXD12/SMISO12/SSCL12/RXD12/IRQ2/ADST1/COMP0	CN7-10	E1, E2 Lite
10	VCL	Connect to capacitor	-
11	MD/FINED	CN7-7	E1, E2 Lite
12	P01/A10/MTIOC9C/MTIOC9C#/GTETRGA/GTETRGA/GTETRGC/GTETRGD/POE12#/TXD9/SMOSI9/SSDA9/TXD12/SMOSI12/SSDA12/TXD12/SIOX12/IRQ4/ADST2/COMP1	CNC-16	FO#_2
13	PE4/A9/MTCLKC/MTCLKC#/GTETRGA/GTETRGA/GTETRGC/GTETRGD/POE10#/SCK9/IRQ1	CND-16	FO#_3
14	PE3/A8/MTCLKD/MTCLKD#/GTETRGA/GTETRGA/GTETRGC/GTETRGD/POE11#/CTS9#/RTS9#/SS9#/IRQ2_DS	CND-14	LED2#_3
15	RES#	RESET, CN7-13	MCU RESET
16	XTAL/P37	Crystal oscillator	MCU oscillating
17	VSS	VSS	VSS
18	EXTAL/P36	Crystal oscillator	MCU oscillating
19	VCC	VCC	VCC
20	UPSEL/PE2/POE10#/NMI	CN1-5	N.C
21	PE1/WR0#/WR#/MTIOC9D/MTIOC9D#/TMO5/CTS5#/RTS5#/SS5#/CTS12#/RTS12#/SS12#/SSLA3/IRQ15	CND-24	SW2#_3
22	PE0/WR1#/BC1#/WAIT#/MTIOC9B/MTIOC9B#/TMC11/TMC11/5/RXD5/SMISO5/SSCL5/SSLA2/CRX0/USB0_OV/RCURB/IRQ7	CND-23	SW1#_3
23	TRST#/PD7/MTIOC9A/MTIOC9A#/GTIOC0A/GTIOC3A/GTIOC0A#/GTIOC3A#/TMRI1/TMRI5/TXD5/SMOSI5/SSDA5/SSLA1/CTX0/IRQ8	CN7-3	E1, E2 Lite
24	TMS/PD6/MTIOC9C/MTIOC9C#/GTIOC0B/GTIOC3B/GTIOC0B#/GTIOC3B#/TMO1/CTS1#/RTS1#/SS1#/CTS11#/RTS11#/SS11#/SSLA0/IRQ5/ADST0	CN7-9	E1, E2 Lite
25	TDI/PD5/GTIOC1A/GTETRGA/GTIOC1A#/TMRI0/TMRI6/RXD1/SMISO1/SSCL1/RXD11/SMISO11/SSCL11/IRQ6	CN7-11	E1, E2 Lite
26	TCK/FINEC/PD4/GTIOC1B/GTETRGA/GTIOC1B#/TMC10/TMC10/6/SCK1/SCK11/IRQ2	CN7-1	E1, E2 Lite
27	TDO/PD3/GTIOC2A/GTETRGA/GTIOC2A#/TMO0/TXD1/SMOSI1/SSDA1/TXD11/SMOSI11/SSDA11	CN7-5	E1, E2 Lite

**Table 6-2 List of RX72T Pin Functions (2/5)**

28	TRCLK/PD2/A7/GTIOC2B/GTIOC0A/GTIOC2B#/GTIOC0A#/ TMC11/TMO4/SCK5/SCK8/MOSIA/USB0_VBUS	CND-35	VRL_3(unused)
29	TRDATA3/PD1/A6/GTIOC3A/GTIOC0B/GTIOC3A#/GTIOC0 B#/TMO2/RXD8/SMISO8/SSCL8/MISOA	CND-27	ENC_A_3
30	TRDATA2/PD0/A5/GTIOC3B/GTIOC1A/GTIOC3B#/GTIOC1 A#/TMO6/TXD8/SMOSI8/SSDA8/RSPCKA	CND-28	ENC_B_3
31	TRDATA7/PF3/A19/CS3#/GTETRGA/TMO7/CTS11#/RTS11 #/SS11#/CRX0/IRQ14/COMP0	CND-13	LED1#_3
32	TRDATA6/PF2/A18/CS2#/GTETRGB/TMO3/SCK11/CTX0/IR Q5/COMP1	CND-34	HALL_W_3
33	TRDATA5/PF1/A17/CS1#/GTETRGC/TMO5/RXD11/SMISO1 1/SSCL11/IRQ13/COMP2	CND-33	HALL_V_3
34	TRDATA4/PF0/A0/BC0#/GTETRGD/TMO1/TXD11/SMOSI11 /SSDA11/IRQ12/COMP3	CND-32	HALL_U_3
35	USB0_DM	-	N.C
36	USB0_DP	-	N.C
37	VSS_USB	VSS	VSS
38	VCC_USB	VCC	VCC
39	TRDATA1/PB7/A4/GTIOC1B/GTIOC1B#/SCK5/SCK11/SCK1 2/USB0_OVRCURB	CND-15	LED3#_3
40	TRDATA0/PB6/A3/GTIOC2A/GTIOC2A#/RXD5/SMISO5/SS CL5/RXD11/SMISO11/SSCL11/RXD12/SMISO12/SSCL12/R XDX12/CRX0/USB0_OVRCURA/IRQ2	CN2-3	SCI5 communication
41	TRSYNC/PB5/A2/GTIOC2B/GTIOC2B#/TXD5/SMOSI5/SSD A5/TXD11/SMOSI11/SSDA11/TXD12/SMOSI12/SSDA12/TX DX12/SIOX12/CTX0/USB0_VBUSEN	CN2-2	SCI5 communication
42	VCC	VCC	VCC
43	TRSYNC1/PB4/A1/GTETRGA/GTETRGB/GTETRGC/GTET RGD/POE8#/CTS5#/RTS5#/SS5#/SCK11/CTS11#/RTS11#/ SS11#/USB0_OVRCURB/IRQ3_DS	CND-29	ENC_Z_3
44	VSS	VSS	VSS
45	PC2/CS1#/MTIOC0D/MTIOC0D#/GTADSM0/SCK8/USB0_ID /USB0_OV/RCURA/IRQ15/ADSM0/COMP5	CN1-6	N.C
46	PC1/A16/MTIOC0C/MTIOC0C#/GTADSM1/TXD8/SMOSI8/S SDA8/USB0_EXICEN/USB0_VBUSEN/IRQ13/ADSM1/COM P4	CN4-2	SCI8 communication
47	PC0/CS0#/MTIOC0B/MTIOC0B#/RXD8/SMISO8/SSCL8/US B0_VBUS/IRQ12/COMP3	CN4-3	SCI8 communication
48	PB3/A7/MTIOC0A/MTIOC0A#/CACREF/SCK6/RSPCKA/IRQ 9	CN1-7	N.C
49	PB2/A6/MTIOC0B/MTIOC0B#/GTADSM0/TMRI0/TXD6/SMO SI6/SSDA6/SDA/ADSM0	CN1-8	N.C
50	PB1/A5/MTIOC0C/MTIOC0C#/GTADSM1/TMCIO/RXD6/SMI SO6/SSCL6/SCL/IRQ4/ADSM1	CN6-3	SCI6 communication
51	PB0/A0/BC0#/A4/MTIOC0D/MTIOC0D#/TMO0/TXD6/SMOSI 6/SSDA6/CTS11#/RTS11#/SS11#/MOSIA/IRQ8/ADTRG2#	CN6-2	SCI6 communication
52	PA7/A15/MTCLKA/MTCLKC/MTCLKA#/MTCLKC#/ GTADSM0/TMO2/RXD11/SMISO11/SSCL11/RXD12/SMISO 12/SSCL12/RXDX12/CRX0/ADSM0	CN3-3	ENC_A_1
53	PA6/A14/MTCLKB/MTCLKD/MTCLKB#/MTCLKD#/ GTADSM1/TMO6/TXD11/SMOSI11/SSDA11/TXD12/SMOSI 12/SSDA12/TXDX12/SIOX12/CTX0/IRQ7/ADSM1	CN3-4	ENC_B_1
54	PA5/A3/MTIOC1A/MTIOC1A#/TMC13/RXD6/SMISO6/SSCL6 /RXD8/SMISO8/SSCL8/MISOA/IRQ1/ADTRG1#	CN3-5	ENC_Z_1

**Table 6-3 List of RX72T Pin Functions (3/5)**

55	PA4/A2/MTIOC1B/MTIOC1B#/TMCI7/SCK6/TXD8/SMOSI8/SSDA8/RSPCKA/ADTRG0#	CN1-9	N.C
56	PA3/A1/MTIOC2A/MTIOC2A#/GTADSM0/TMRI7/TXD9/SMOSI9/SSDA9/SCK8/SSLA0	CNC-29	ENC_Z_2
57	PA2/A0/BC0#/MTIOC2B/TIOC2B#/GTADSM1/TMO7/CTS6#/RTS6#/SS6#/RXD9/SMISO9/SSCL9/SCK11/SSLA1	CN1-10	N.C
58	PA1/MTIOC6A/MTIOC6A#/TMO4/TXD9/SMOSI9/SSDA9/RXD11/SMISO11/SSCL11/SSLA2/CRX0/USB0_ID/USB0_OVRCURA/IRQ14_DS/ADTRG0#	CNA-4	VRL_1(UNUSED)
59	PA0/MTIOC6C/MTIOC6C#/TMO2/SCK9/TXD11/SMOSI11/SSDA11/SSLA3/CTX0/USB0_EXICEN/USB0_VBUSEN	CNA-14	SW2#_1
60	P35/A13/MTIOC2A/MTIOC9A/MTIOC2A#/MTIOC9A#/GTADSM0/TMO0/CTS8#/RTS8#/SS8#/TXD1/SMOSI1/SSDA1/IRQ6	CNA-13	SW1#_1
61	P34/A12/MTIOC2B/MTIOC9B/MTIOC2B#/MTIOC9B#/GTADSM1/GTETRGA/TMO4/CTS9#/RTS9#/SS9#/RXD1/SMISO1/SSCL1/USB0_OVRCURB/IRQ3	CNA-3	LED3#_1
62	PC6/MTIOC1A/MTIOC9C/MTIOC1A#/MTIOC9C#/RXD11/SMISO11/SSCL11/CRX0/IRQ11_DS	CNA-2	LED2#_1
63	PC5/MTIOC1B/MTIOC9D/MTIOC1B#/MTIOC9D#/TXD11/SMOSI11/SSDA11/CTX0/IRQ10_DS	CNA-1	LED1#_1
64	VCC	VCC	VCC
65	P96/CS0#/WAIT#/GTETRGA/GTETRGA/GTETRGC/GTETRGD/POE4#/CTS8#/RTS8#/SS8#/IRQ4_DS	CN1-11	N.C
66	VSS	VSS	VSS
67	P95/MTIOC6B/MTIOC6B#/GTIOC4A/GTIOC7A/GTIOC4A#/GTIOC7A#	CNC-22	UP_2
68	P94/MTIOC7A/MTIOC7A#/GTIOC5A/GTIOC8A/GTIOC5A#/GTIOC8A#	CNC-21	VP_2
69	P93/MTIOC7B/MTIOC7B#/GTIOC6A/GTIOC9A/GTIOC6A#/GTIOC9A#	CNC-20	WP_2
70	P92/MTIOC6D/MTIOC6D#/GTIOC4B/GTIOC7B/GTIOC4B#/GTIOC7B#	CNC-19	UN_2
71	P91/MTIOC7C/MTIOC7C#/GTIOC5B/GTIOC8B/GTIOC5B#/GTIOC8B#	CNC-18	VN_2
72	P90/MTIOC7D/MTIOC7D#/GTIOC6B/GTIOC9B/GTIOC6B#/GTIOC9B#	CNC-17	WN_2
73	P76/D0/MTIOC4D/MTIOC4D#/GTIOC2B/GTIOC6B/GTIOC2B#/GTIOC6B#	CNA-7	WN_1
74	P75/D1/MTIOC4C/MTIOC4C#/GTIOC1B/GTIOC5B/GTIOC1B#/GTIOC5B#	CNA-8	VN_1
75	P74/D2/MTIOC3D/MTIOC3D#/GTIOC0B/GTIOC4B/GTIOC0B#/GTIOC4B#	CNA-9	UN_1
76	P73/D3/MTIOC4B/MTIOC4B#/GTIOC2A/GTIOC6A/GTIOC2A#/GTIOC6A#	CNA-10	WP_1
77	P72/D4/MTIOC4A/MTIOC4A#/GTIOC1A/GTIOC5A/GTIOC1A#/GTIOC5A#	CNA-11	VP_1
78	P71/D5/MTIOC3B/MTIOC3B#/GTIOC0A/GTIOC4A/GTIOC0A#/GTIOC4A#	CNA-12	UP_1
79	P70/D6/GTETRGA/GTETRGA/GTETRGC/GTETRGD/POE0#/CTS9#/RTS9#/SS9#/IRQ5_DS	CNA-5	FO#_1

Table 6-4 List of RX72T Pin Functions (4/5)

80	PG2/D11/GTETRGA/GTIOC0B/GTIOC0B#/SCK9/IRQ2/COM P0	CND-19	UN_3
81	PG1/D12/GTIOC0A/GTIOC0A#/TXD9/SMOSI9/SSDA9/IRQ1/COMP1	CND-22	UP_3
82	PG0/D13/GTIOC1B/GTIOC1B#/RXD9/SMISO9/SSCL9/IRQ0/COMP2	CND-18	VN_3
83	PK2/D14/GTIOC1A/GTIOC1A#/POE12#/CTS9#/RTS9#/SS9#/SCK5/IRQ9_DS/COMP3	CND-21	VP_3
84	PK1/D15/GTIOC2B/GTIOC2B#/POE13#/CTS8#/RTS8#/SS8#/TXD5/SMOSI5/SSDA5/IRQ8_DS/COMP4	CND-17	WN_3
85	PK0/CS1#/GTIOC2A/GTIOC2A#/POE14#/RXD5/SMISO5/SSCL5/IRQ15_DS/COMP5	CND-20	WP_3
86	P33/D7/MTIOC3A/MTCLKA/MTIOC3A#/MTCLKA#/GTIOC3B/GTIOC3B#/TMO0/SSLA3/IRQ13_DS	CN1-12	N.C
87	P32/D8/MTIOC3C/MTCLKB/MTIOC3C#/MTCLKB#/GTIOC3A/GTIOC3A#/TMO6/SSLA2/IRQ12_DS	CN1-15	N.C
88	VCC	VCC	VCC
89	P31/D9/MTIOC0A/MTCLKC/MTIOC0A#/MTCLKC#/TMRI6/SLA1/IRQ6	CNC-27	ENC_A_2
90	VSS	VSS	VSS
91	P30/D10/MTIOC0B/MTCLKD/MTIOC0B#/MTCLKD#/TMCI6/SCK8/CTS8#/RTS8#/SS8#/SSLA0/IRQ7/COMP3	CNC-28	ENC_B_2
92	P27/CS3#/MTIOC1A/MTIOC0C/MTIOC1A#/MTIOC0C#/POE9#/IRQ15	CN1-16	N.C
93	P26/CS2#/MTIOC9A/MTIOC9A#/CTS1#/RTS1#/SS1#/IRQ11/ADST0	CN1-17	N.C
94	P25/CS3#/MTIOC9C/MTIOC9C#/SCK1/IRQ10/ADST1	CN5-5	HALL_W_1
95	P24/D11/MTIC5U/MTIC5U#/TMCI2/TMO6/CTS8#/RTS8#/SS8#/SCK8/RSPCKA/IRQ4/COMP0	CN5-4	HALL_V_1
96	P23/D12/MTIC5V/MTIC5V#/TMO2/CACREF/TXD8/SMOSI8/SSDA8/TXD12/SMOSI12/SSDA12/TXDX12/SIOX12/MOSIA/CTX0/IRQ11/COMP1	CN5-3	HALL_U_1
97	P22/D13/MTIC5W/MTCLKD/MTIC5W#/MTCLKD#/MTIOC9B/TMRI2/TMO4/RXD8/SMISO8/SSCL8/RXD12/SMISO12/SSCL12/RXDX12/MISOA/CRX0/IRQ10/ADTRG2#/COMP2	CN1-18	N.C
98	PC4/A20/MTIOC9B/MTIOC9B#/TXD1/SMOSI1/SSDA1/TXD12/SMOSI12/SSDA12/TXDX12/SIOX12/ADST2/COMP5	CN1-19	N.C
99	PC3/MTIOC9D/MTIOC9D#/RXD1/SMISO1/SSCL1/RXD12/SMISO12/SSCL12/RXDX12/IRQ14/COMP4	CN1-20	N.C
100	P21/D14/MTIOC9A/MTCLKA/MTIOC9A#/MTCLKA#/TMCI4/TXD8/SMOSI8/SSDA8/TXD12/SMOSI12/SSDA12/TXDX12/SIOX12/MOSIA/IRQ6_DS/AN217/ADTRG1#/COMP5	CN1-21	N.C
101	P20/D15/MTIOC9C/MTCLKB/MTIOC9C#/MTCLKB#/TMRI4/CTS8#/RTS8#/SS8#/SCK8/RSPCKA/IRQ7_DS/AN216/ADTRG0#/COMP4	CN1-22	N.C
102	P65/A12/IRQ9/AN211/CMPC53/DA1	CN1-25	N.C
103	P64/A13/IRQ8/AN210/CMPC33/DA0	CN1-26	N.C
104	AVCC2	AVCC	AVCC

Table 6-5 List of RX72T Pin Functions (5/5)

105	AVCC2	AVCC	AVCC
106	AVSS2	AVSS	AVSS
107	P63/A14/A12/IRQ7/AN209/CMPC23	CNB-8	VPN_1
108	P62/A15/A13/IRQ6/AN208/CMPC43	CNB-12	VW_1
109	P61/A16/A14/IRQ5/AN207/CMPC13	CNB-11	VV_1
110	P60/A17/A15/IRQ4/AN206/CMPC03	CNB-10	VU_1
111	P55/A18/A16/IRQ3/AN203/CMPC32	CNC-2	VPN_2
112	P54/A19/A17/IRQ2/AN202/CMPC22	CNC-9	VW_2
113	P53/A20/A18/IRQ1/AN201/CMPC12	CNC-8	VV_2
114	P52/IRQ0/AN200/CMPC02	CNC-7	VU_2
115	P51/AN205/CMPC52	CN1-27	N.C
116	P50/AN204/CMPC42	CND-5	IW_3
117	PH7/AN106/CVREFC1	CND-9	VW_3
118	PH6/AN105	CND-8	VV_3
119	PH5/AN104	CND-7	VU_3
120	P47/AN103	CND-4	IV_3
121	P46/AN102/CMPC50/CMPC51	CNC-5	IW_2
122	P45/AN101/CMPC40/CMPC41	CNC-4	IV_2
123	P44/AN100/CMPC30/CMPC31	CNC-3	IU_2
124	PH4/AN107/PGAVSS1	CNC-1	PGAVSS_2
125	PH3/AN006/CVREFC0	CN1-28	N.C
126	PH2/AN005	CND-2	VPN_3
127	PH1/AN004	CND-3	IU_3
128	P43/AN003	CNB-15	VR_1
129	P42/AN002/CMPC20/CMPC21	CNB-7	IW_1
130	P41/AN001/CMPC10/CMPC11	CNB-6	IV_1
131	P40/AN000/CMPC00/CMPC01	CNB-5	IU_1
132	PH0/AN007/PGAVSS0	CNB-4	PGAVSS_1
133	AVCC1	AVCC	AVCC
134	AVCC0	AVCC	AVCC
135	AVSS0	AVSS	AVSS
136	AVSS1	AVSS	AVSS
137	P82/ALE/WAIT#/MTIC5U/MTIC5U#/TMO4/SCK6/SCK12/IRQ3/COMP5	CN1-29	N.C
138	P81/CS2#/MTIC5V/MTIC5V#/TMC14/TXD6/SMOSI6/SSDA6/TXD12SMOSI12/SSDA12/TXDX12/SIOX12/COMP4	CN1-30	N.C
139	P80/CS1#/MTIC5W/MTIC5W#/TMRI4/RXD6/SMISO6/SSCL6/RXD12/SMISO12/SSCL12/RDX12/IRQ5/COMP3	CN1-31	N.C
140	P11/RD#/MTIOC3A/MTCLKC/MTIOC3A#/MTCLKC#/MTIOC9D/GTIOC3B/GTETRGA/GTIOC3B#/GTETRGC/TMO3/POE9#/IRQ1_DS	CN1-32	N.C
141	P10/MTIOC9B/MTCLKD/MTIOC9B#/MTCLKD#/GTETRGB/GTETRGD/TMRI3/POE12#/CTS6#/RTS6#/SS6#/IRQ0_DS	CNC-35	VRL_2(unused)
142	P17/MTIOC4D/MTIOC4D#/GTIOC2B/GTIOC9B/GTIOC2B#/GTIOC9B#/IRQ14	CNC-15	LED3#_2
143	P16/MTIOC4C/MTIOC4C#/GTIOC1B/GTIOC8B/GTIOC1B#/GTIOC8B#/IRQ13	CNC-14	LED2#_2
144	P15/MTIOC3D/MTIOC3D#/GTIOC0B/GTIOC7B/GTIOC0B#/GTIOC7B#/IRQ12	CNC-13	LED1#_2



## 7. Caution Items

The product includes some unused pins that have not been processed. For information on accurate pin processing, refer to the hardware manual of the microcontroller.

## Website and Support

Renesas Electronics Website

<http://www.renesas.com/>

Inquiries

<http://www.renesas.com/contact/>

All trademarks and registered trademarks are the property of their respective owners.

## Revision History

Rev.	Date	Description	
		Page	Summary
1.00	Feb. 21, 2019	-	First edition issued
1.10	Feb. 21, 2022		Modified Table 6-12 Revised the description for the compatible inverter board Revised Section 4 (Usage)

---