

User Manual

DA1458x/DA1468x Production Line Tool

UM-B-041

Abstract

This document describes the DA1458x/DA1468x Production Line Tool (PLT). The various software applications, as well as the PLT hardware are explained in detail. The purpose of this document is to help users to become familiar with the tool and help them use it in a short amount of time.

Contents

Abstract	1
Contents	2
Figures	6
Tables	10
1 Terms and Definitions	13
2 References	15
3 New version features	16
4 Introduction	17
5 Hardware	18
5.1 Hardware Block Diagram	18
5.2 Printed Circuit Board Layout	19
5.3 PLT Power Supply	20
5.4 DUT Connector	20
5.5 Data Streaming	21
5.6 Golden Unit	23
5.6.1 GU Reset	23
5.7 Current Measurements	24
5.8 Jumper Settings	24
5.8.1 J26 - Current Measurements	25
5.8.2 J42 - DA1458x OTP Burning Voltage	25
5.8.3 J47, J46 - GU Reset	26
5.8.4 J37 - GU Programming.....	26
5.9 PLT Functional Blocks	28
6 Software	29
6.1 Introduction	29
6.2 DA15101 support	30
6.3 Software Package Contents	30
6.4 Prerequisites	33
6.5 System Requirements.....	34
6.6 Limitations	34
6.7 Building the Code.....	35
6.8 Executing the Applications	37
6.9 Test Sequence	42
6.9.1 DA1458x Test Sequence	42
6.9.2 DA1468x Test Sequence.....	47
6.10 VBAT/Reset Signals Operation.....	52
6.10.1 VBAT Only	52
6.10.2 VBAT On with Reset.....	53
6.10.3 VBAT as Reset	53
6.11 Custom Memory Data	54
6.11.1 Homekit Hash Setup Code	55
6.11.2 Custom data CSV file format	57
6.12 Golden Unit Scan Test.....	58
6.13 Creating PLT Firmware Files	60

DA1458x/DA1468x Production Line Tool

7	Applications	65
7.1	Introduction	65
7.2	CFG PLT Application	65
7.2.1	XML and XSD Files	67
7.2.2	Hardware Setup	69
7.2.2.1	Station Identification	69
7.2.2.2	Device IC	69
7.2.2.3	Active DUTs	69
7.2.2.4	DUT COM Ports	70
7.2.2.5	Golden Unit	70
7.2.2.6	VBAT/Reset Mode	71
7.2.3	General	72
7.2.3.1	Statistics	72
7.2.3.2	Test Options	72
7.2.4	BD Addresses	74
7.2.4.1	BD Address Assignment	74
7.2.5	DUT Hardware Setup (DA1458x)	77
7.2.5.1	UART Boot Pins Setup	77
7.2.5.2	UART Baud Rate	77
7.2.5.3	UART Programming GPIOs Setup	78
7.2.5.4	Sleep Clock Source	78
7.2.5.5	SPI Flash Configuration	79
7.2.5.6	I2C EEPROM Configuration	80
7.2.5.7	Range Extender Configuration	81
7.2.6	Test Settings (DA1458x)	82
7.2.6.1	XTAL Trim	82
7.2.6.2	GPIO Watchdog operation	82
7.2.6.3	Scan DUT Advertise Test	83
7.2.6.4	RF Tests	83
7.2.6.5	GPIO/LED Test	90
7.2.6.6	GPIO Connection Test	91
7.2.6.7	Audio Test	92
7.2.6.8	Sensor Test	92
7.2.6.9	Custom Test	93
7.2.6.10	External 32kHz Test	94
7.2.6.11	Current Measurement Test	95
7.2.6.12	Temperature Measurement Test	98
7.2.6.13	Scan Test	98
7.2.7	Memory Functions (DA1458x)	100
7.2.7.1	OTP Memory	100
7.2.7.2	SPI Flash Memory	101
7.2.7.3	I2C EEPROM Memory	103
7.2.7.4	Memory read	104
7.2.8	Memory Header (DA1458x)	105
7.2.8.1	General	105
7.2.8.2	BD Address	106
7.2.8.3	Custom Memory Data	107

DA1458x/DA1468x Production Line Tool

7.2.9	DUT Hardware Setup (DA1468x)	109
7.2.9.1	UART Boot Pins Setup	109
7.2.9.2	UART Baud Rate	109
7.2.9.3	Clock Source	110
7.2.10	Test Settings (DA1468x).....	111
7.2.10.1	XTAL Trim.....	111
7.2.10.2	GPIO Watchdog operation	111
7.2.10.3	Scan DUT Advertise Test	112
7.2.10.4	RF Tests	112
7.2.10.5	GPIO/LED Test.....	118
7.2.10.6	GPIO Connection Test.....	119
7.2.10.7	Sensor Test	120
7.2.10.8	ADC Calibration (DA14681-00 only).....	121
7.2.10.9	Custom Test	121
7.2.10.10	External 32kHz Test	122
7.2.10.11	Current Measurement Test.....	123
7.2.10.12	Temperature Measurement Test	126
7.2.10.13	Scan Test.....	126
7.2.11	Memory Functions (DA1468x).....	128
7.2.11.1	OTP Memory	128
7.2.11.2	QSPI Flash Memory	129
7.2.11.3	Memory read.....	130
7.2.12	Memory Header (DA1468x).....	131
7.2.12.1	OTP Header.....	131
7.2.12.2	OTP Header - BD Address	133
7.2.12.3	OTP Header - XTAL Trim	133
7.2.12.4	QSPI Header - BD Address.....	134
7.2.12.5	QSPI Header - XTAL Trim.....	134
7.2.12.6	Custom Memory Data	135
7.2.13	Debug Settings	137
7.2.14	Security	137
7.3	GUI PLT Application.....	138
7.3.1	GUI PLT Settings.....	141
7.3.2	Barcode Scanner Mode	142
7.3.2.1	Homekit Setup Code Scan Example	143
7.3.3	Running the GUI PLT and Executing Tests.....	148
7.3.4	Debug Console	151
7.3.5	DUT Log File.....	152
7.3.6	CSV File.....	153
7.4	CLI PLT Application	154
7.4.1	CLI Commands.....	154
7.4.2	Running the CLI and Executing Tests	156
7.4.3	Using CLI Commands as Arguments	159
7.5	GU Upgrade Application	160
8	Example Usage	166
	Appendix A Top-view of PLT PCB Version D	173
	Appendix B Electrical Schematics	174

DA1458x/DA1468x Production Line Tool

Appendix C Hardware Modifications PLT Version D	178
Appendix D Suggestions about Hardware and Cabling.....	179
Appendix E RF Path Losses Calibration.....	181
E.1 Prerequisites	181
E.2 Setup.....	182
E.3 Procedure.....	184
Appendix F Hex2Bin.....	190
Appendix G Bin2Image	191
Appendix H Automatic GU COM Port Find	192
Appendix I Improving Cabling between PLT and DUTs	194
Appendix J DA14583 Internal SPI Flash Memory.....	196
Appendix K DA14586 Internal SPI Flash Memory	197
Appendix L Honeywell Xenon 1900 Barcode Scanner Setup	198
Appendix M Golden Unit Upgrade Using Smart Snippets Toolbox	199
Appendix N Connecting a Speaker to the Golden Unit for Audio Test.....	200
Appendix O FTDI Driver Removal and Installation	201
Appendix P DA1458x DK Pro Motherboard Connection	202
Appendix Q DA1468x DK Pro Motherboard Connection.....	203
Appendix R Connecting DA1468x DK Pro Motherboard for Current Measurements.....	204
Appendix S Connecting DUT with Battery Supply.....	206
Appendix T User Interfaces Shortcut Keys	207
Appendix U DA1458x Supported SPI Flash\EEPROM Memories	208
Appendix V DA1468x Supported QSPI Flash Memories	209
Appendix W BLE Tester Measurement Results	210
Appendix X Memory programming.....	214
X.1 DA14580/1/2/3/5/6 Memory Programming Tests	214
X.2 DA1468x Memory Programming Operation.....	217
Appendix Y CSV Log File Contents.....	219
Appendix Z DUT Status Codes	232
Appendix AA Golden Unit Status Codes	242
Revision History	245

DA1458x/DA1468x Production Line Tool
Figures

Figure 1: Production Line Tool Hardware.....	17
Figure 2: Production Line Tool Hardware Board Block Diagram	18
Figure 3: Top View of the PLT Hardware Board (Version C)	19
Figure 4: PLT Hardware Power Connections.....	20
Figure 5: Production Line Tool DUT Connections.....	20
Figure 6: CPLD UART Data Streams.....	21
Figure 7: CPLD XTAL Trim Pulse Data Stream	22
Figure 8: CPLD UART Loopback Data Stream	22
Figure 9: Golden Unit	23
Figure 10: GU Reset Circuit	24
Figure 11: VBAT DUT Current Measurement Setup.....	24
Figure 12: Connections for 'Floating Current' Measurements.....	25
Figure 13: VPP Control Circuit Schematic	25
Figure 14: Location of the VPP Jumper J42.....	26
Figure 15: Location of J46 Jumper	26
Figure 16: Location of J47 Jumper.....	26
Figure 17: J37 - GU Programming Jumper Schematics	27
Figure 18: Location of J37 Jumper.....	27
Figure 19: PLT Functional Blocks	28
Figure 20: Production Line Tool Software Block Diagram	29
Figure 21: DA1458x/DA1468x PLT Software Package Contents	30
Figure 22: DA1458x Test Sequence	46
Figure 23: DA1468x Test Sequence	51
Figure 24: VBAT only	52
Figure 25: VBAT On with Reset	53
Figure 26: VBAT as Reset.....	53
Figure 27: Custom Memory Data CSV File Example.....	57
Figure 28: Golden Unit Scan Test.....	58
Figure 29: Golden Unit Scan Test Example Parameters	59
Figure 30: Binaries	60
Figure 31: Folder Contents of 'fw_files'	61
Figure 32: CFG PLT Startup Screen	65
Figure 33: CFG PLT with Erroneous Configuration Parameter.....	66
Figure 34: XSD Schema File Example.....	68
Figure 35: Station Identification.....	69
Figure 36: Device IC.....	69
Figure 37: Active DUTs	69
Figure 38: DUT COM Ports	70
Figure 39: Golden Unit COM Port	70
Figure 40: VBAT/Reset Mode Selection.....	71
Figure 41: Statistics	72
Figure 42: Test Options.....	72
Figure 43: BD Address Assignment	74
Figure 44: Example for Load from File Mode	75
Figure 45: UART Boot Pins Setup - DA1458x.....	77
Figure 46: UART Baud Rate - DA1458x	77
Figure 47: UART Programming GPIOs Setup - DA1458x	78
Figure 48: Sleep Clock Source - DA1458x.....	78
Figure 49: SPI Flash Configuration - DA1458x	79
Figure 50: I2C EEPROM Configuration - DA1458x	80
Figure 51: Range Extender Configuration - DA1458x.....	81
Figure 52: XTAL Trim - DA1458x.....	82
Figure 53: GPIO Watchdog operation - DA1458x.....	82
Figure 54: Scan DUT Advertise Test - DA1458x	83
Figure 55: Golden Unit RF Tests - DA1458x.....	84
Figure 56: BLE Tester General Settings - DA1458x	85
Figure 57: BLE Tester TX Power - DA1458x	86
Figure 58: BLE Tester Frequency Offset - DA1458x	87

DA1458x/DA1468x Production Line Tool

Figure 59: BLE Tester Modulation Index - DA1458x.....	88
Figure 60: BLE Tester RX Sensitivity - DA1458x.....	89
Figure 61: Path Losses per DUT - DA1458x.....	90
Figure 62: GPIO/LED Tests - DA1458x.....	90
Figure 63: GPIO Connection Test - DA1458x.....	91
Figure 64: Audio Test.....	92
Figure 65: Sensor Test - DA1458x.....	92
Figure 66: Custom Test - DA1458x.....	93
Figure 67: External 32kHz Test - DA1458x.....	94
Figure 68: Current Measurement Test - DA1458x.....	95
Figure 69: Temperature Measurement Test - DA1458x.....	98
Figure 70: Scan Test - DA1458x.....	98
Figure 71: OTP Memory - DA1458x.....	100
Figure 72: Different Image per DUT Folder Example.....	101
Figure 73: SPI Flash Memory - DA1458x.....	101
Figure 74: I2C EEPROM Memory - DA1458x.....	103
Figure 75: Memory Read Test - DA1458x.....	104
Figure 76: Memory Read Test Example Log File - DA1458x.....	104
Figure 77: OTP Header - DA1458x.....	105
Figure 78: BD Address - DA1458x.....	106
Figure 79: Custom Memory Data - DA1458x.....	107
Figure 80: UART Boot Pins Setup - DA1468x.....	109
Figure 81: UART Baud Rate - DA1468x.....	109
Figure 82: Clock Source - DA14682/3-00 Only.....	110
Figure 83: XTAL Trim - DA1468x.....	111
Figure 84: GPIO Watchdog operation - DA1468x.....	111
Figure 85: Scan DUT Advertise Test - DA1468x.....	112
Figure 86: Golden Unit RF Tests - DA1468x.....	112
Figure 87: BLE Tester General Settings - DA1468x.....	113
Figure 88: BLE Tester TX Power - DA1468x.....	114
Figure 89: BLE Tester Frequency Offset - DA1468x.....	115
Figure 90: BLE Tester Modulation Index - DA1468x.....	116
Figure 91: BLE Tester RX Sensitivity - DA1468x.....	117
Figure 92: Path Losses per DUT - DA1468x.....	118
Figure 93: GPIO/LED Tests - DA1468x.....	118
Figure 94: GPIO Connection Tests - DA1468x.....	119
Figure 95: Sensor Test - DA1468x.....	120
Figure 96: ADC Calibration - DA14681-00.....	121
Figure 97: Custom Test - DA1468x.....	121
Figure 98: External 32kHz Test - DA1468x.....	122
Figure 99: Current Measurement Tests - DA1468x.....	123
Figure 100: Temperature Measurement Test - DA1468x.....	126
Figure 101: Scan Test - DA1468x.....	126
Figure 102: OTP Memory - DA1468x.....	128
Figure 103: QSPI Flash - DA1468x.....	129
Figure 104: Memory Read Test - DA1468x.....	130
Figure 105: Memory Read Test Example Log File - DA1468x.....	130
Figure 106: OTP Header - DA1468x.....	131
Figure 107: OTP Header BD Address - DA1468x.....	133
Figure 108: OTP Header XTAL Trim - DA1468x.....	133
Figure 109: QSPI Header BD Address - DA1468x.....	134
Figure 110: QSPI Header XTAL Trim.....	134
Figure 111: Custom Memory Data - DA1468x.....	135
Figure 112: Debug Settings.....	137
Figure 113: Security.....	137
Figure 114: GUI PLT Main Screen.....	139
Figure 115: GUI PLT Settings.....	141
Figure 116: Barcode Scan Option in GUI PLT.....	142
Figure 117: Barcode Scanner Controls.....	143

DA1458x/DA1468x Production Line Tool

Figure 118: Barcode Scan - BD Address Assignment	143
Figure 119: GUI PLT - Erroneous Messages in “run scripts before testing starts”	148
Figure 120: GUI PLT OTP Burn Warning Message	149
Figure 121: GUI PLT Testing (1 of 2)	149
Figure 122: GUI PLT Testing (2 of 2)	150
Figure 123: GUI PLT Tests Finished.....	150
Figure 124: GUI PLT Retry Failed DUTs Message	151
Figure 125: Debug Console.....	151
Figure 126: DUT Log File	152
Figure 127: CSV File	153
Figure 128: CLI Software Start Screen	154
Figure 129: CLI PLT Print Settings (x Command).....	156
Figure 130: CLI PLT DUT COM Port Enumeration ('p' Command).....	157
Figure 131: CLI PLT Read and Compare BD Address in QSPI ('v' Command)	158
Figure 132: CLI PLT Testing	158
Figure 133: CLI PLT Testing Finished.....	158
Figure 134: CLI with Commands as Arguments.....	159
Figure 135: GU Upgrade - Introduction page	160
Figure 136: GU Upgrade - Exit Message	161
Figure 137: GU Upgrade - Hardware Version	161
Figure 138: GU Upgrade - Hardware Version Compatibility	161
Figure 139: GU Upgrade - Power Supply.....	162
Figure 140: GU Upgrade - Power Supply Pop-Up	162
Figure 141: GU Upgrade - Golden Unit Reset	163
Figure 142: GU Upgrade - Golden Unit Reset Message for Manual Mode	163
Figure 143: GU Upgrade - GU COM Port	164
Figure 144: GU Upgrade - Burn Firmware	164
Figure 145: GU Upgrade - Burn Firmware Pop-Up Message	165
Figure 146: GU Upgrade - Burn Firmware Success	165
Figure 147: Top-view of PLT PCB Version D.....	173
Figure 148: VBAT and VPP Control from CPLD	174
Figure 149: CPLD DUT UART Connections	174
Figure 150: CPLD FTDI and GU Control Connections	175
Figure 151: FTDI Chip for USB UART to DUTs 1, 2, 3 and 4	175
Figure 152: Quad USB HUB	176
Figure 153: Golden Unit - Dedicated USB Port and FTDI Chip	176
Figure 154: Golden Unit - GU LED and SPI Flash Memory.....	177
Figure 155: VBAT_DUT and VDDIO Supplies	177
Figure 156: GU Supply and VPP Generation.....	177
Figure 157: DA14580_RD_tester Version D	178
Figure 158: Jumper J47 Added Next to Golden Unit Socket	178
Figure 159: R365 (10 kΩ) Added Next to Reset Button.....	178
Figure 160: R365, J47 and RESET Shown in Electrical Schematic	178
Figure 161: Possible Solution of Antenna on Cable and Fixed Radius of DUTs to Antenna.....	179
Figure 162: Possible Solution of Antenna on Cable and DUTs Put in Line	179
Figure 163: Example Locations and RSSI Readouts of Horizontal Antenna	180
Figure 164: Setup diagram	182
Figure 165: Hex2Bin Example Directory with Files	190
Figure 166: Hex2Bin.exe Example	190
Figure 167: Bin2Image Example Directory with Files	191
Figure 168: Bin2Image Example	191
Figure 169: Example of Twisted Pair Cable with 4 Pairs and Ferrite.....	194
Figure 170: Location of Pull-Down Resistors	194
Figure 171: Anti-Ringing Solution.....	195
Figure 172: Pin Assignment of DA14583 – QFN40	196
Figure 173: Pin Assignment of DA14586 - QFN40	197
Figure 174: Speaker Connection for Audio Test.	200
Figure 175: DA14580/5 Pro Motherboard DK Wiring.....	202
Figure 176: DA14680/1/2/3 Pro Motherboard DK Wiring.....	203

DA1458x/DA1468x Production Line Tool

Figure 177: DA1468x PRO DK Ammeter Connection with PLT 204
Figure 178: DA1468x DK PRO Current Measurement Settings 205
Figure 179: CSV File Entries (1/4) 224
Figure 180: CSV File Entries (2/4) 225
Figure 181: CSV File Entries (3/4) 229
Figure 182: CSV File Entries (4/4) 231

DA1458x/DA1468x Production Line Tool

Tables

Table 1: DA1458x_DA1468x_PLT_v4.3 added features	16
Table 2: Power Supply Requirements	20
Table 3: PLT Connections to Applications	21
Table 4: Jumpers	24
Table 5: PLT User Interface Application Executables	30
Table 6: Executables Folder Description	31
Table 7: Production Line Tool Prerequisites	33
Table 8: Minimum System Requirements	34
Table 9: Opening the PLT Visual Studio 2015 Express Source Code Solution	35
Table 10: DA1458x_DA1468x_CFG_PLT.exe Application Execution	37
Table 11: DA1458x_DA1468x_GUI_PLT.exe Application Execution	39
Table 12: DA1458x_DA1468x_CLI_PLT.exe Application Execution	40
Table 13: GU_fw_upgrade.exe Application Execution	41
Table 14: DA1458x Test Sequence	42
Table 15: DA1468x Test Sequence	47
Table 16: Custom Memory Data Input Modes	54
Table 17: Homekit Setup Code Format	55
Table 18: Homekit Setup Code Checksum Algorithm	56
Table 19: CFG PLT Main Menu Options	66
Table 20: CFG PLT Bottom Strip Options	66
Table 21: XML File Parts	67
Table 22: Station Identification	69
Table 23: Device IC	69
Table 24: Active DUTs	70
Table 25: DUT COM Ports	70
Table 26: Set the GU COM Port	71
Table 27: Golden Unit Firmware Version Upgrade	71
Table 28: VBAT/Reset Mode	71
Table 29: Statistics	72
Table 30: Test Options	73
Table 31: BD Address Assignment - Standard Mode	75
Table 32: BD Address Assignment Options - Range Mode	75
Table 33: BD Address Assignment Options - Load from File Mode	76
Table 34: BD Address Assignment Options - Scan Mode	76
Table 35: UART TX-RX Pins - DA1458x	77
Table 36: UART Baud Rate - DA1458x	77
Table 37: UART Programming GPIOs Setup - DA1458x	78
Table 38: Sleep Clock Source - DA1458x	79
Table 39: SPI Pin Setup - DA1458x	79
Table 40: SPI Flash Configuration - SPI Flash Options - DA1458x	80
Table 41: I2C Pin Setup - DA1458x	81
Table 42: I2C EEPROM Configuration – EEPROM Memory Options - DA1458x	81
Table 43: Range Extender Configuration - DA1458x - DA1458x	81
Table 44: XTAL Trim - DA1458x	82
Table 45: GPIO Watchdog operation - DA1458x	82
Table 46: Scan DUT Advertise Test - DA1458x	83
Table 47: Golden Unit RF Tests - DA1458x	84
Table 48: BLE Tester General Settings - DA1458x	85
Table 49: BLE Tester TX Power - DA1458x	86
Table 50: BLE Tester Frequency Offset - DA1458x	87
Table 51: BLE Tester Modulation Index - DA1458x	88
Table 52: BLE Tester RX Sensitivity - DA1458x	89
Table 53: Path Losses per DUT from RF Tests DA1458x Options	90
Table 54: GPIO/LED Tests - DA1458x	91
Table 55: GPIO Connection Test - DA1458x	91
Table 56: Audio Test	92
Table 57: Sensor Tests - DA1458x	92
Table 58: Custom Tests - DA1458x	93

DA1458x/DA1468x Production Line Tool

Table 59: External 32kHz Test - DA1458x	94
Table 60: Current Measurement Test – Instrument Settings - DA1458x	96
Table 61: Current Measurement Test – Peripheral Current Measurement - DA1458x.....	96
Table 62: Current Measurement Test - Sleep Current Measurement - DA1458x.....	97
Table 63: Temperature Measurement Test - DA1458x.....	98
Table 64: Scan Test DA1458x Options	99
Table 65: OTP Memory - DA1458x	100
Table 66: SPI Flash Erase - DA1458x	101
Table 67: SPI Flash Image Write - DA1458x	102
Table 68: I2C EEPROM Image Write - DA1458x.....	103
Table 69: Memory Read Test - DA1458x.....	104
Table 70: OTP Header - DA1458x	105
Table 71: BD Address - DA1458x	107
Table 72: Custom Memory Data - DA1458x	108
Table 73: UART TX-RX Pins - DA1468x.....	109
Table 74: UART Baud Rate - DA1468x.....	110
Table 75: Clock Source - DA14682/3-00 Only	110
Table 76: XTAL Trim - DA1468x	111
Table 77: GPIO Watchdog operation - DA1468x	111
Table 78: Scan DUT Advertise Test - DA1468x.....	112
Table 79: Golden Unit RF Tests - DA1468x.....	113
Table 80: BLE Tester General Settings - DA1468x	113
Table 81: BLE Tester TX Power - DA1468x.....	114
Table 82: BLE Tester Frequency Offset - DA1468x.....	115
Table 83: BLE Tester Modulation Index - DA1468x.....	116
Table 84: BLE Tester RX Sensitivity - DA1468x	117
Table 85: Path Losses per DUT from RF Tests DA1468x Options.....	118
Table 86: GPIO/LED Tests - DA1468x.....	119
Table 87: GPIO Connection Tests - DA1468x	119
Table 88: Sensor Tests - DA1468x	120
Table 89: ADC Calibration - DA14681-00	121
Table 90: Custom Tests DA1468x Options	122
Table 91: External 32kHz Tests DA1468x Options.....	122
Table 92: Current Measurement Tests - DA1468x	124
Table 93: Current Measurement Test – Peripheral Current Measurement - DA1468x.....	124
Table 94: Current Measurement Test - Sleep Current Measurement - DA1468x.....	125
Table 95: Temperature Measurement Test - DA1468x.....	126
Table 96: Scan Test DA1468x Options	127
Table 97: OTP Memory - DA1468x	128
Table 98: QSPI Flash Erase - DA1468x.....	129
Table 99: QSPI Flash Image Write - DA1468x.....	130
Table 100: Memory Read Test - DA1468x.....	131
Table 101: General - OTP Header DA1468x Options	132
Table 102: OTP Header BD Address - DA1468x.....	133
Table 103: OTP Header XTAL Trim - DA1468x	134
Table 104: QSPI Header BD Address - DA1468x.....	134
Table 105: QSPI Header XTAL Trim	134
Table 106: Custom Memory Data - DA1468x	135
Table 107: Debug Settings	137
Table 108: Security Options	138
Table 109: GUI PLT Main Screen Description	139
Table 110: GUI PLT Settings.....	141
Table 111: Homekit Setup Code Scan Example	143
Table 112: CLI Commands.....	154
Table 113: DA14580 PLT Example Usage	166
Table 114: RF Test RSSI Results	180
Table 115: Prerequisites.....	181
Table 116: Calibration Setup	182
Table 117: Procedure steps	184

DA1458x/DA1468x Production Line Tool

Table 118: FTDI "DialogSemi" Serial Number	192
Table 119: DA14583 Internal SPI Flash Connections.....	196
Table 120: DA14586 Internal SPI Flash Connections.....	197
Table 121: User Interface Shortcut Keys	207
Table 122: DA1458x Supported SPI Flash Memories	208
Table 123: DA1468x Supported QSPI Flash Memories.....	209
Table 124: MT8852B Supported Command Codes	210
Table 125: MT8852B – BLE TX Output Power Test Results	210
Table 126: MT8852B – BLE Carrier Frequency Offset and Drift Test Results	211
Table 127: MT8852B – BLE Modulation Characteristics Test Results	211
Table 128: MT8852B – Error List	212
Table 129: DA1458x Memory Programming – OTP Memory	214
Table 130: DA1458x Memory Programming - SPI Flash	215
Table 131: DA1458x Memory Programming – EEPROM Memory	216
Table 132: DA1468x Memory Programming – OTP Memory	217
Table 133: Memory Programming – QSPI Memory	218
Table 134: CSV File Contents	219
Table 135: CSV File Entries (1/4).....	224
Table 136: CSV File Entries (2/4).....	225
Table 137: CSV File Entries (3/4).....	229
Table 138: CSV File Entries (4/4).....	231
Table 139: DUT Status Codes.....	232
Table 140: Golden Unit Status Codes.....	242

DA1458x/DA1468x Production Line Tool

1 Terms and Definitions

API	Application Programming Interface
BD	Bluetooth Device
.bin	Firmware files in binary format
BLE	Bluetooth low energy
CFG	Configuration
CLI	Command Line Interface
COM	Communication port
CPLD	Complex Programmable Logic Device
CRC	Cyclic redundancy check
CSV	Comma Separated Values
DLL	Dynamic Link Library
DMA	Direct Memory Access
DMM	Digital Multi-meter
DTM	Direct Test Mode (as specified by the BLE Core standard)
DUT	Device Under Test
DVM	Digital Voltage Meter
EEPROM	Electrically Erasable Programmable Read-Only Memory
.exe	Executable file
FTDI	Future Technology Devices International Ltd.
GPIO	General Purpose Input-Output
GU	Golden Unit
GUI	Graphical User Interface
.hex	Firmware file in hexadecimal format
HW	hardware
IC	Integrated Circuit
IDE	Integrated Development Environment
I2C	Inter-Integrated Circuit
JTAG	Joint Test Action Group
OS	Operating System
OTP	One Time Programmable (memory)
PC	Personal Computer
PCB	Printed circuit board
PER	Packet Error Rate
PLT	Production Line Tool
PLTD	Production Line Tool DLL
POR	Power-On Reset
RAM	Random Access Memory
RCX	Resistor Crystal Oscillator
RF	Radio Frequency
RX	Receive
SCPI	Standard Commands for Programmable Instruments
SoC	System on Chip
SDK	Software Development Kit
SPI	Serial Peripheral Interface
SW	Software
TCS	Trim and Calibration Section

DA1458x/DA1468x Production Line Tool

TX	Transmit
UART	Universal Asynchronous Receiver/Transmitter
UI	User Interface
USB	Universal Serial Bus
VISA	Virtual Instrument Software Architecture
VPP	Programming supply voltage (pin)
XML	Extensible Markup Language
XTAL	Crystal
XSD	XML Schema Definition

DA1458x/DA1468x Production Line Tool

2 References

- [1] UM-B-040, DA1458x/DA1468x Production Line Tool, User manual, Dialog Semiconductor.
- [2] UM-B-014, DA1458x Bluetooth Smart Development Kit - Expert, User Manual, Dialog Semiconductor
- [3] [FT4232H – Hi-Speed Quad USB UART IC](#), FTDI Chip.
- [4] [FT232 – USB UART IC](#), FTDI Chip
- [5] Anritsu MT8852B, <https://www.anritsu.com/en-US/test-measurement/products/mt8852b>
- [6] Keysight 34401A, <http://www.keysight.com/en/pd-1000001295%3Aeps%3Apro-pn-34401A/digital-multimeter-6-digit?cc=US&lc=eng>
- [7] Keithley 2000, <http://www.tek.com/tektronix-and-keithley-digital-multimeter/keithley-2000-series-6%C2%BD-digit-multimeter-scanning>
- [8] Papouch TMU USB thermometer, <https://www.papouch.com/en/shop/product/tmu-usb-thermometer/>
- [9] NI USB TC-01, <http://sine.ni.com/nips/cds/view/p/lang/en/nid/208177>
- [10] Honeywell Xenon 1900, <https://www.honeywellaidc.com/products/barcode-scanners/general-duty/xenon-1900g-1902g>
- [11] Zebra/Motorola LS2208, <https://www.zebra.com/us/en/products/scanners/general-purpose-scanners/handheld/ls2208.html>
- [12] AN-B-020, DA14580 End product testing and programming guidelines, Application Note, Dialog Semiconductor
- [13] Litepoint IQxel-M, <http://www.litepoint.com/test-solutions-for-manufacturing/iqxel-m/>
- [14] NI USB-6009 DAQ, <http://sine.ni.com/nips/cds/view/p/lang/en/nid/201987>
- [15] Keysight 34461A, <http://www.keysight.com/en/pd-2270273-pn-34461A/digital-multimeter-6-digit-34401a-replacement-truevolt-dmm?cc=GR&lc=eng>

DA1458x/DA1468x Production Line Tool
3 New version features

This manual explains the usage of the 16 channel DA1458x/DA1468x Production Line Tool (PLT). It refers to the DA1458x_DA1468x_PLT_v4.3 software release, which compared to DA1458x_DA1468x_PLT_v4.2 has the added features illustrated in [Table 1](#).

Table 1: DA1458x_DA1468x_PLT_v4.3 added features

#	Features	Description
1	Automated GU firmware upgrade.	A new GUI application executable was created (<code>GU_fw_upgrade.exe</code>) to automate the process of the Golden Unit firmware upgrade.
2	External 32kHz connection test.	Added a connection test of the external low power 32kHz crystal oscillator.
3	HID barcode scanner.	Barcode scanner mode now supports HID barcode scanner devices.
4	DA14585/6 range extender tests.	Range extender tests were added. These are available for DA14585/6 devices.
5	Write OTP image & OTP header in a single binary.	User can now burn a single binary in the OTP that could contain both the OTP firmware and the OTP header part.
6	Improvements for DA14683 secure boot.	Added new OTP header fields (OTP image length, CRC, Secure device), to help the operations of creating a secure device product.
7	DA14682/3, DA15101 XTAL 32MHz support.	DA14682/3, DA15101 devices with XTAL 32MHz crystal are now supported. New test firmware files were added for both production and memory programming tests.
8	Warning pop-up window when any OTP write is enabled.	If an OTP memory area is going to be burned, a window will pop-up with a warning informing the user that the OTP memory is going to be burned. This option can be disabled.
9	Peripheral current measurements.	Current measurement for attached peripherals (LEDs on GPIOs, buzzer, or custom). Improved current measurement algorithm.
10	GPIO toggle for external watchdog circuit.	A GPIO can be selected by the user to toggle every 2sec in order to keep an external watchdog circuit alive.
11	DA1468x Pro-DK motherboard as current measurement instrument.	This version supports the DA1468x Pro-DK current meter module to be used for the current measurement tests.
12	Set/Get GPIO status test.	GPIO correct operation test, either as a pair with another GPIO to set and get the correct state, or sensing a high/low state. Available for all ICs.
13	DA1458x configurable SPI and EEPROM memories.	User can now configure the memory to be used, without having to rebuild the flash programmer firmware. Also more SPI flash memories are now supported by default.
14	DA1458x memory enable GPIO.	User can select a GPIO to go high before any memory action. This can be used in case the hardware product design has a memory enable GPIO.
15	DA1458x sleep clock selection (needed for boost mode).	The sleep clock can be selected, either external 32Khz or the internal RCX. This selection is crucial for products that operate in boost mode.
16	OTP TCS section write.	The tool can now burn the OTP TCS area. User has only to set the data to be burned in the TCS area. PLT automatically finds the first available empty TCS entry.
17	Scan advertisements using the production test firmware	A new production test was added that uses HCI advertisement commands to set the device into advertisement mode. The GU scans the air to find the DUT advertisements and reports the RSSI. This test is very similar to measuring the DUT TX power.
18	Added PER limits in RF RSSI tests.	In all RF reception tests, Packet Error Rate limit was added.

4 Introduction

By using the PLT, it is possible to test, calibrate and load firmware for 16 different devices under test (DUTs) in parallel.

The following are deliverable parts of the tool.

- Hardware
 - Main board (Figure 1) together with a DA14580-QFN48 Golden Unit.
 - Electrical schematics of the main board.
 - Gerber files of the main board.
 - Bill of Materials of the main board.
- Software
 - Source code files organized in a Microsoft® Visual Studio Express 2015 solution.
 - Application executables and required DLLs.
- Documents.

An example of a sequence of actions the tool performs is given below. All actions are performed in parallel for up to 16 devices.

1. Download the production test firmware (e.g. prod_test_580.bin).
2. Perform automatic crystal (XTAL) trimming.
3. Perform RF RSSI test.
4. Download and burn the customer firmware (into OTP, SPI flash, QSPI flash or I2C EEPROM)
5. Burn the OTP header.
6. Perform Scan test. Reset the DUTs and set the GU to scan for the DUT BLE advertisements.

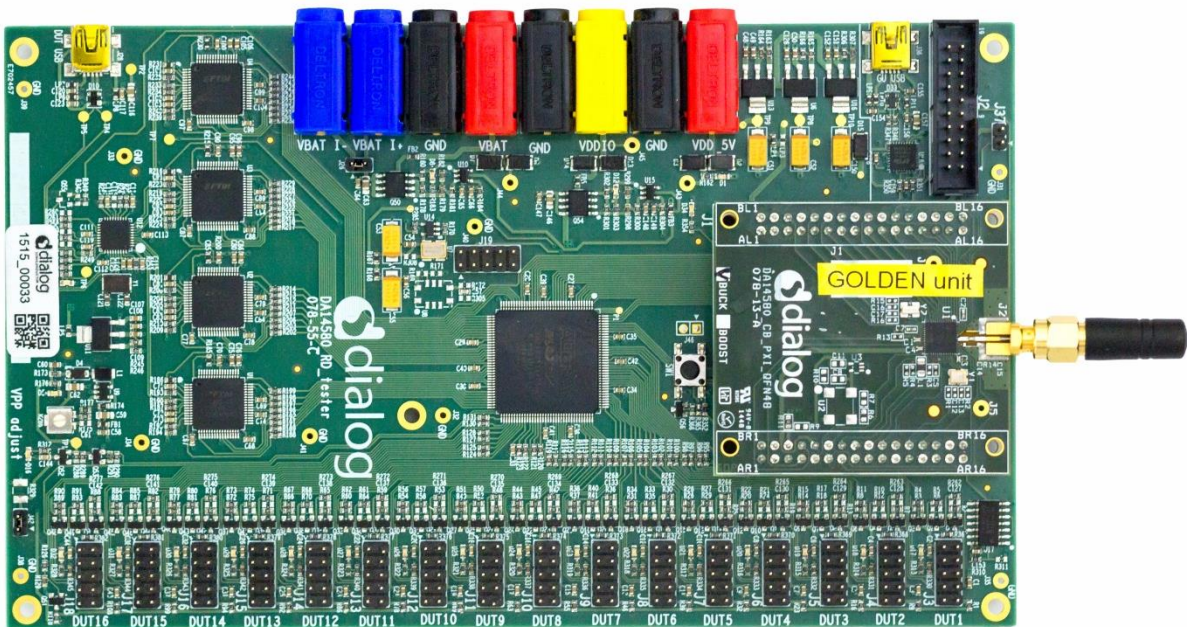

Figure 1: Production Line Tool Hardware

5 Hardware

5.1 Hardware Block Diagram

The Production Line Tool hardware consists of various blocks, as illustrated in Figure 2. These blocks are explained below.

- **Blue blocks:** USB-to-UART interfaces.
 - Four **FT4232 FTDI QUAD** USB-to-UART interfaces are used for a 16-channel USB-to-UART conversion.
 - The GU is connected to the PC via an **FT232 FTDI** USB-to-UART interface.
- **Red block:** A **CPLD** that has the following purpose.
 - Switch UART signals between the PC USB-UART and DUTs.
 - Switch DUTs VBAT signal
 - Switch DUTs VPP signal (only when VBAT is enabled).
 - Produce Reset signal to the DUTs.
 - Produce 500ms XTAL calibration pulse.
- **Orange block:** A **Golden Unit** (GU) is mounted, which has the following functionality:
 - CPLD control using custom commands.
 - Transceiver for Bluetooth RF signals to and from the DUTs.
 - Produce an audio tone using PWM, used for audio testing.
 - Scan for device BLE advertisements, after the customer firmware has been programmed.
- **Purple blocks:** Sixteen (16) device connectors.

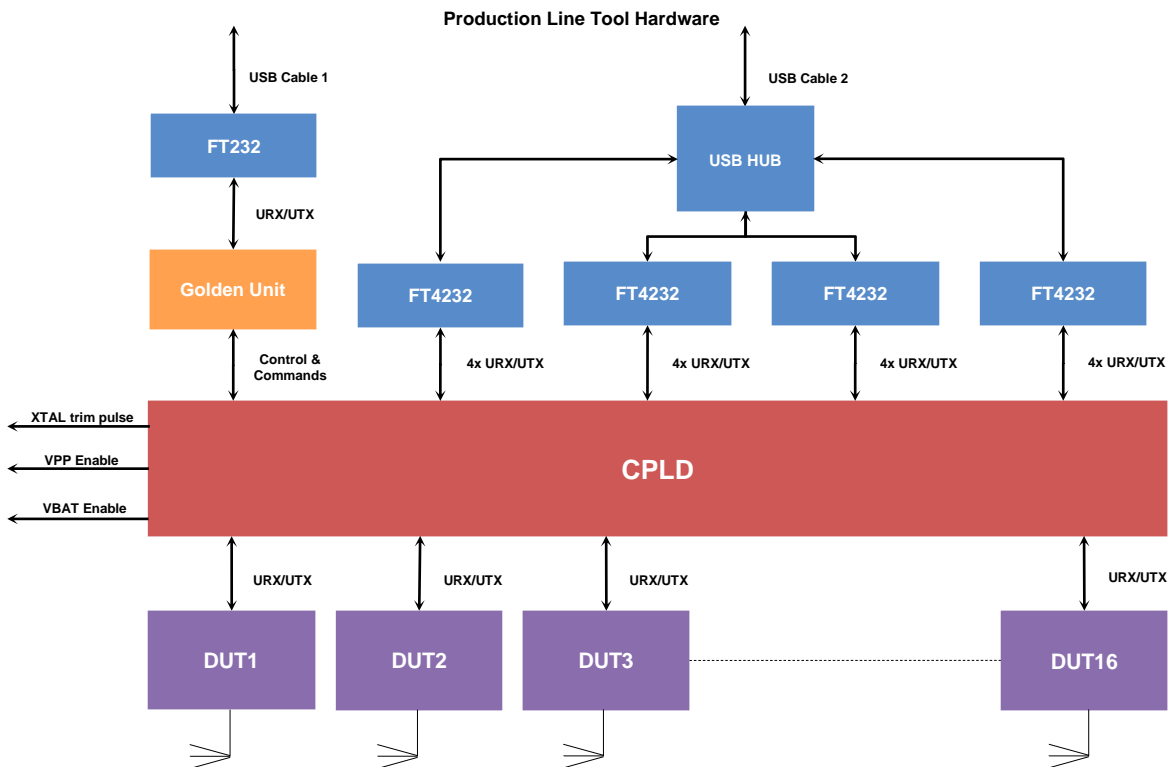

Figure 2: Production Line Tool Hardware Board Block Diagram

DA1458x/DA1468x Production Line Tool

5.2 Printed Circuit Board Layout

In Figure 3, the top view of the PLT board is illustrated. The important parts are pointed by the orange boxes. The VPP jumper and the Current jumper are colored in blue.

The Golden Unit has a DA14580 QFN48-die soldered. Most of the 48 pins are basically used to connect to the CPLD. The CPLD is programmed during the production of the PLT board via the CPLD socket. No need for the users to use the CPLD socket.

The black banana sockets are all connected to the same ground (GND) plane.

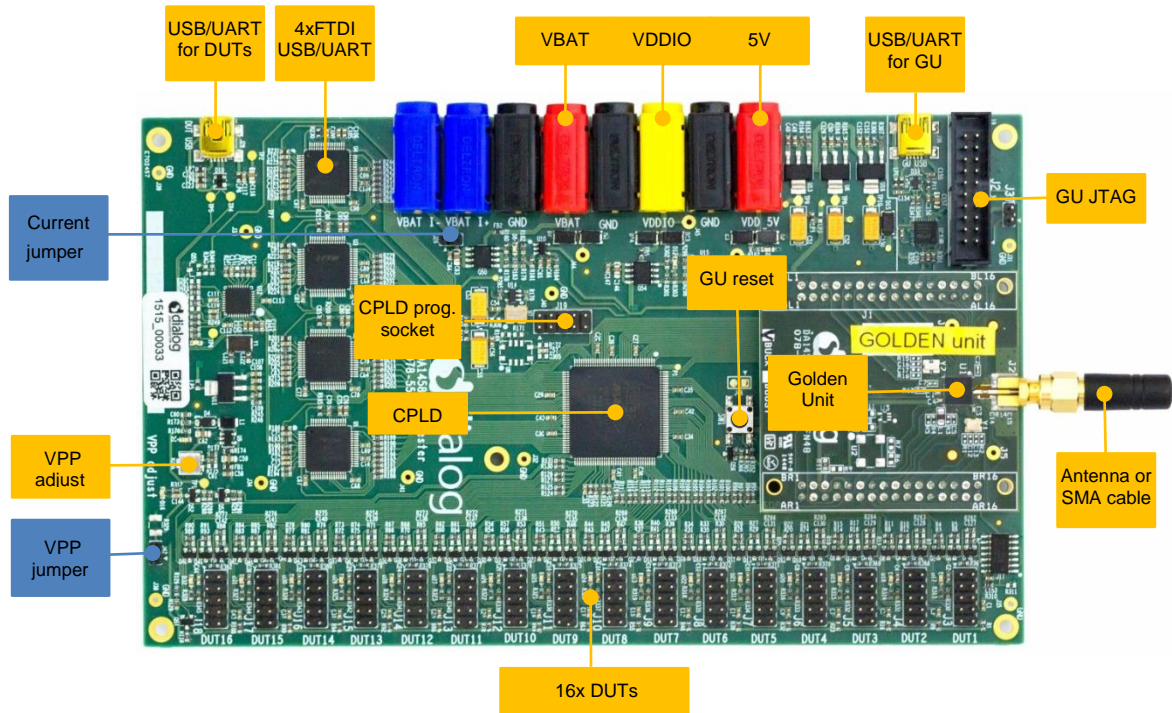

Figure 3: Top View of the PLT Hardware Board (Version C)

DA1458x/DA1468x Production Line Tool

5.3 PLT Power Supply

External power supply is needed for the PLT to run. This should be connected to the banana sockets as shown in Figure 4.

Table 2 shows the voltage and current requirements for each power supply. The blue banana sockets can be used for device current measurements.



Figure 4: PLT Hardware Power Connections

Table 2: Power Supply Requirements

Power Supply	Voltage (V)	Current (mA)	
		Buck Mode	Boost Mode
VBAT (Buck mode)	2.4 ... 3.3	16 x 20	
VBAT (Boost mode)	1.5 ... 3.3		16 x 20
VDDIO	2.4 ... 3.3	70	70
VDD 5V	4.75 ... 5.25	~335	~335
VPP	6.6 ... 6.8	16 x 2	16 x 2

5.4 DUT Connector

The BLE devices are connected to the PLT using the DUT1-16 connectors at the edge of the PLT board. Figure 5 shows the pin-header connections from the Production Line Tool hardware board to the DUTs. Table 3 describes the purpose of each pin.

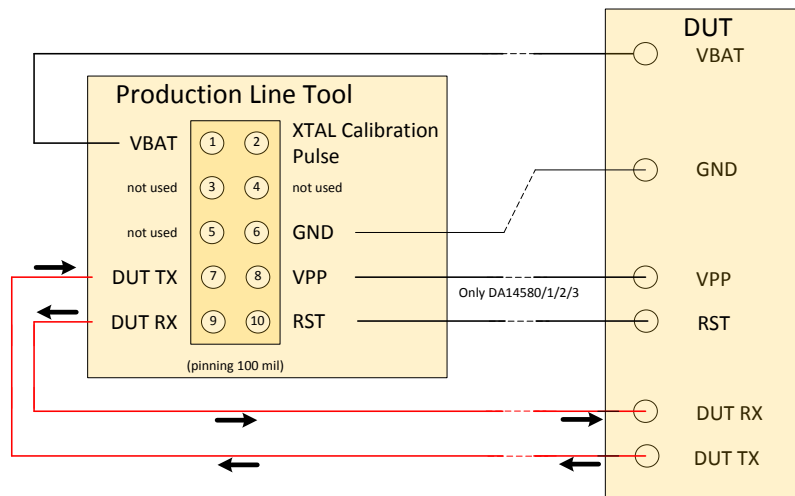

Figure 5: Production Line Tool DUT Connections

Table 3: PLT Connections to Applications

Header Pin	Name	Description
1	VBAT	Depending on the VBAT/Reset Signals Operation mode this can be used as Voltage supply for the DUT or as Reset signal. Due to this connection, no external power supply is needed for the DUTs. This pin must be connected if there is no other power supply (e.g. battery).
2	XTAL Calibration Pulse	This pin can be used as a reference pulse during the automatic crystal calibration. More details are given in 7.2.6.1 for DA1458x devices and in 7.2.10.1 for DA1468x devices. The crystal trim pulse can also be supplied in the UART RX device pin. This is the most common scenario. However, there may be hardware limitations where the UART RX pin cannot be used. In such cases, the particular PLT header pin is used.
6	GND	Ground pin. This pin must be connected.
7	DUT TX	This is connected to the device UART TX pin. This pin must be connected.
8	VPP	This pin provides the 6.8V required to program the OTP in the DA14580/1/2/3 devices. Note: This option is not available with the VBAT as Reset mode.
9	DUT RX	This is connected to the device UART RX pin. This pin can also provide the crystal calibration reference pulse for the automatic crystal (XTAL) trim procedure, as described in 7.2.6.1 for DA1458x devices and in 7.2.10.1 for DA1468x devices. This pin must be connected.
10	RST	The reset signal must be connected if battery powered devices are used. A power cycle of VBAT will produce a Power on Reset (POR), so a RESET is given to the DUT. In that case the RST-wire is not needed. In summary, when no battery is used, the POR will RESET the DUT.

5.5 Data Streaming

Figure 6, Figure 7 and Figure 8 illustrate the three possible data streams through the CPLD. The CPLD switches S1, S2, S3 and S4 are controlled by the software via the Golden Unit.

Normal Operation (Figure 6):

UART-RxD data is transported via the RED arrows (AA):

PC → USB → USB HUB → Quad UART → CPLD signal 'AA' → DUT RxD (programmed as RxD).

UART-TxD data is transported via the BLUE arrows (BB):

PC ← USB ← USB HUB ← Quad UART ← CPLD signal 'BB' ← DUT TxD.

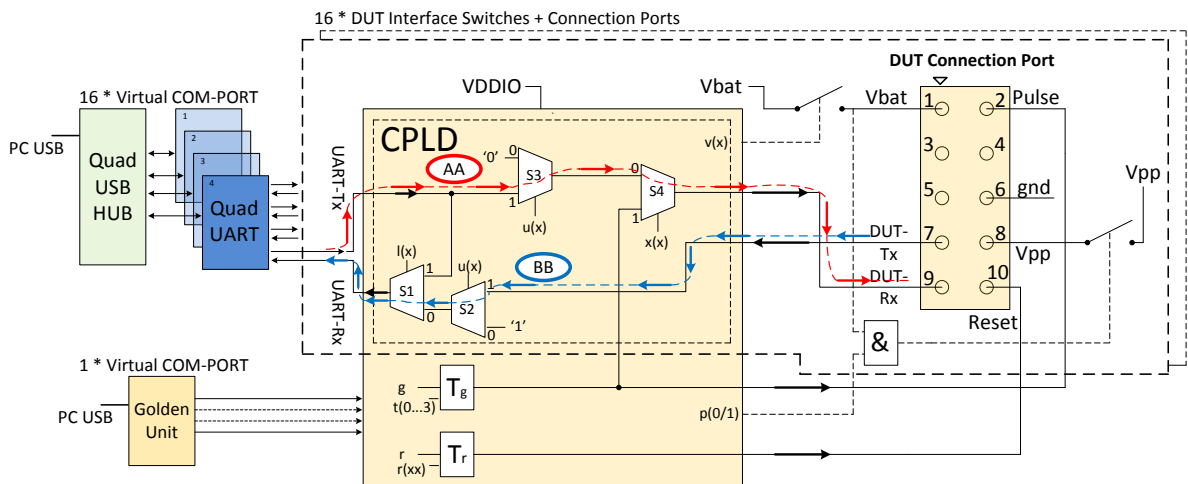

Figure 6: CPLD UART Data Streams

DA1458x/DA1468x Production Line Tool

Crystal Trimming (Figure 7):

The XTAL calibration pulse (500ms) is transported via the PURPLE arrows (CC):
 CPLD TIMER T_g → CPLD S4 → DUT RxD (programmed as GPIO).

UART-TxD data is transported via the BLUE arrows (BB):
 PC ← USB ← USB HUB ← Quad UART ← CPLD signal 'BB' ← DUT TxD.

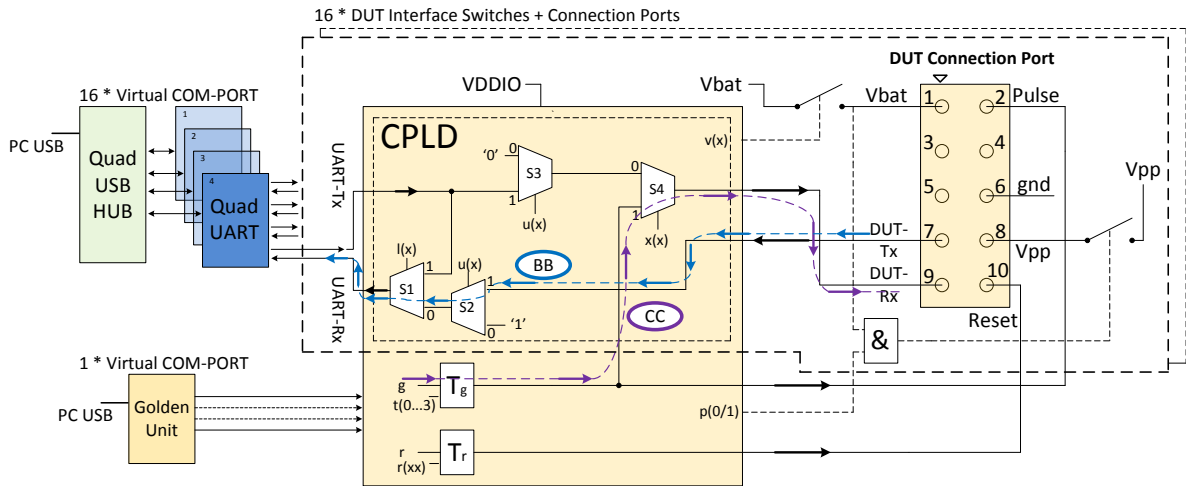

Figure 7: CPLD XTAL Trim Pulse Data Stream

Loopback Operation (Figure 8):

Loopback operation is used during the start of the tests. The PC PLT software uses this feature to automatically find the numbers of the Virtual COM ports in the Windows PC.

The UART loopback data is transported via the GREEN arrows (DD):
 PC → USB → USB HUB → Quad UART → CPLD signal 'DD' SW1 → Quad UART → USB HUB → USB → PC.

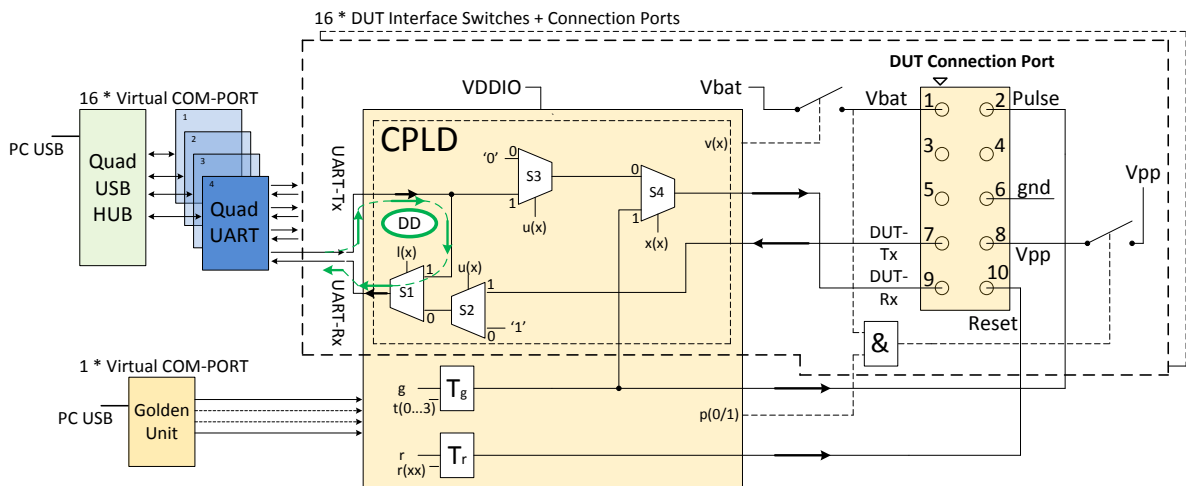

Figure 8: CPLD UART Loopback Data Stream

Note: The CPLD is also used to switch the UART signals between the QUAD FTDIs and the DUTs. When the VBAT is switched off and the UART wires are not disconnected, a 'rest voltage' may be present on the product. This could cause problems with the power-on reset (POR) and the product might not boot correctly. The CPLD will switch off the UART signals when the VBAT is not present.

5.6 Golden Unit



Figure 9: Golden Unit

The Golden Unit (GU) is a 'daughter' board mainly used in the Expert Development Kit [2]. In the PLT, the GU is used for various purposes:

- RF transmitter for the RF RSSI DUT test.
- RF Receiver for the device BLE advertisement scan test.
- Audio tone generator for the audio test.
- Controlling the CPLD.

The GU uses an SPI Flash memory mounted on the PLT board. The SPI Flash is pre-programmed with a specific production test firmware. If required, there are several ways to upgrade the GU firmware, either via the PLT's GU JTAG connector, via the UART or using a new GUI application executable (`GU_fw_upgrade.exe`) as explained in 7.5. The latest GU firmware can be found inside the latest PLT software release, under the `executables\binaries\GU` folder.

Note: PLT v4.3 and onwards requires the latest firmware version of the Golden Unit. If the Golden Unit firmware is not updated, then the PLT applications will not run.

Note: The Golden Unit is calibrated during PLT production. It is delivered with a calibration characterization document.

5.6.1 GU Reset

The Golden Unit includes a hardware reset circuit. The GU reset signal is connected to an FTDI FT232 GPIO pin.

Figure 10 illustrates the electrical schematics of the GU reset circuit. Section 5.8.3 illustrates the jumper positions on the PLT PCB.

The red line is the connection between the FTDI IC GPIO pin (DTR) and the GU reset signal on the PLT GU connector header. The PLT software controls this pin via the FTDI DLL driver `ftd2xx.dll`. Making pin DTR low for a short period of time will reset the GU. Every time the PLT tests start, a hardware reset is issued to the Golden Unit. Jumper J47 should be ON and J46 OFF for this reset method to operate.

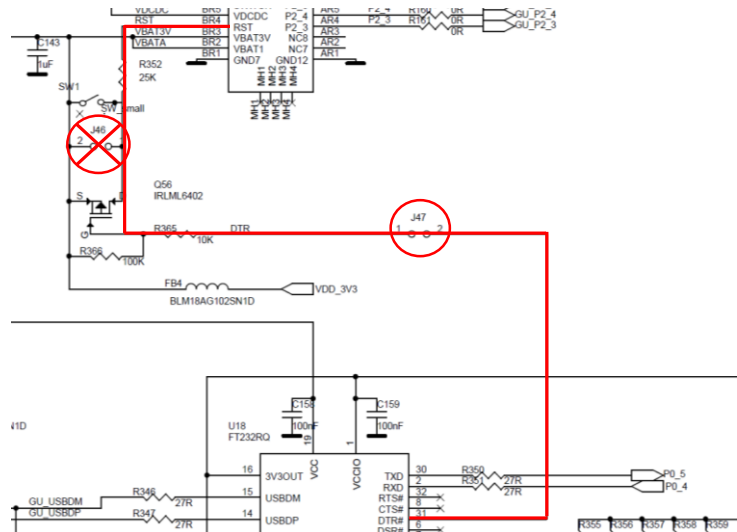

Figure 10: GU Reset Circuit

5.7 Current Measurements

The PLT board provides connections to perform DUT current measurements (see Figure 11). By connecting a current meter to the blue banana sockets, the combined VBAT current of all DUTs can be measured. Jumper J26 should be removed when a current meter is connected. If no current meter is used, jumper J26 should be mounted. See also section 5.8.

The connection shown in Figure 11 can only be used with the **VBAT Only** and **VBAT On with Reset** (when the VBAT lines are used to power the DUTs) modes. If the DUTs are powered using a single external power supply, then the multi-meter should be connected on that power supply in a similar way as described before with the PLT. If the DUTs are powered independently (e.g. each one with its own battery) the current measurement procedure cannot be used.

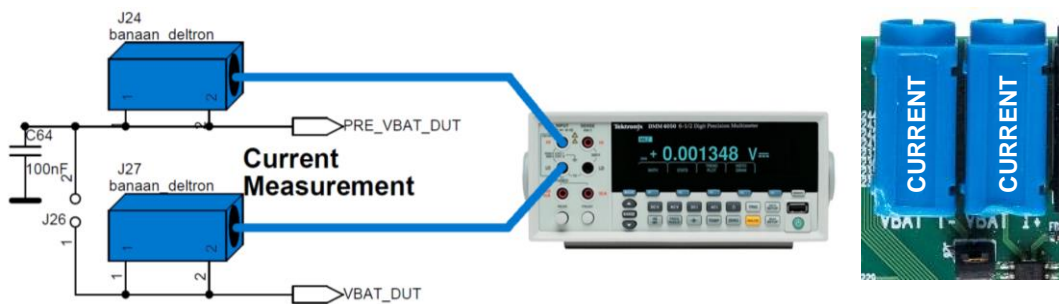

Figure 11: VBAT DUT Current Measurement Setup

5.8 Jumper Settings

This section describes the PLT hardware jumper settings.

Table 4: Jumpers

Jumper	PLT HW version	Description
J26	A, B, C, D	Connects the VBAT line from the PLT power supply to the DUTs. This jumper can be used when there is no multi-meter instrument connected for current measurement.
J37	B, C, D	This jumper sets the Golden Unit's SPI Flash chip select (CS) pin to high. This jumper is needed placed when the Golden Unit should NOT boot from the SPI flash.

Jumper	PLT HW version	Description
J42	B, C, D	Feeds the VPP lines of the DUT connectors with VPP voltage used for OTP burning in DA14580/1/2/3 DUTs.
J46	C, D	This jumper can be used to reset the Golden Unit. The two pins on the jumper are the same as the ones in the GU reset switch next to the jumper.
J47	D	This jumper connects the Golden Unit's FTDI DTR line to the Golden Unit's reset pin. With this jumper on the PLT, software can reset the Golden Unit on-demand.

5.8.1 J26 - Current Measurements

As shown in Figure 12, jumper J26 should be mounted when no external current meter is attached. Otherwise, when a current meter is connected via the blue banana sockets to measure the device current, the J26 jumper should be removed.

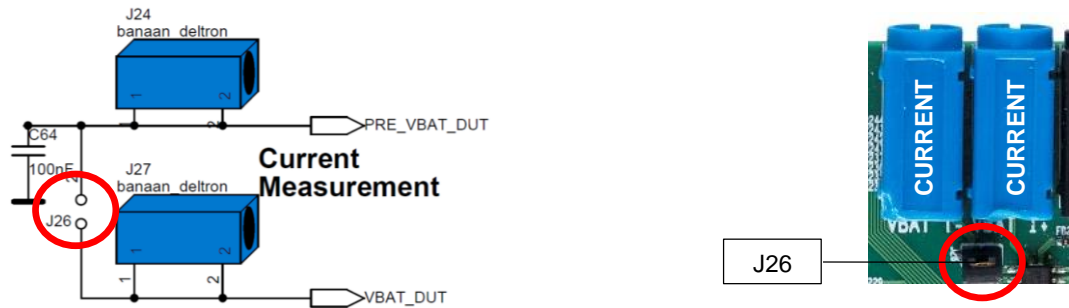

Figure 12: Connections for 'Floating Current' Measurements

5.8.2 J42 - DA1458x OTP Burning Voltage

If DA14580/1/2/3 OTP programming is required, the VPP line should be connected between the PLT DUT connector and the actual DUT (Figure 5). Jumper J42 on the PLT board should also be mounted. Figure 14 shows the jumper position on the PLT hardware board. Figure 13 illustrates the electrical schematics of the VPP and the location of the J42 jumper.

DA14585/6 and DA1468x devices do not need an external voltage for the OTP to be burned. Therefore, the VPP line from the PLT DUT connector (Figure 5) should not be connected to the DA1468x DUT.

Note: The VPP line feature **cannot** be used with the VBAT as Reset mode, because of the fact that the VPP line will not operate when VBAT is not switched on. It is secured in the hardware.

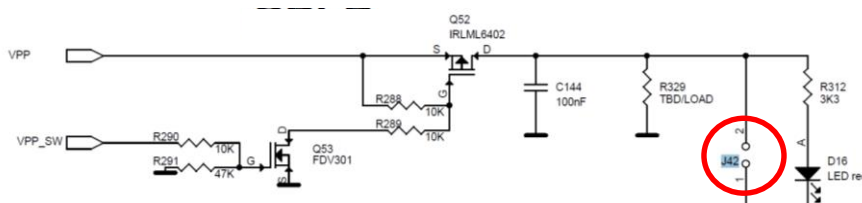

Figure 13: VPP Control Circuit Schematic

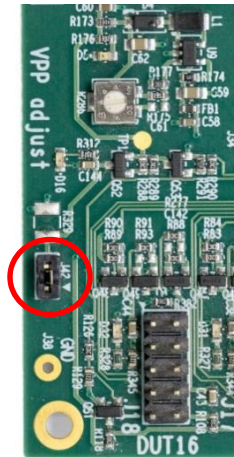

Figure 14: Location of the VPP Jumper J42

5.8.3 J47, J46 - GU Reset

For a GU hardware reset, jumper J47 should be mounted and jumper J46 should be removed. These two jumpers are involved in the circuit illustrated in Figure 10. In this way, the PLT software will control the GU hardware reset. Figure 15 shows the jumper placement on the actual PCB.



Figure 15: Location of J46 Jumper

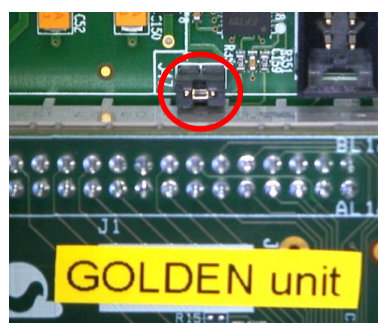

Figure 16: Location of J47 Jumper

5.8.4 J37 - GU Programming

Jumper J37 connects the Chip Select of the GU SPI Flash to a logic high level. This causes the GU not to boot from the already programmed SPI Flash, allowing the GU to load different code into its System-RAM via the JTAG connector or via UART. Figure 17 shows the circuit schematic and Figure 18 shows the location of jumper J37 on the PLT PCB.

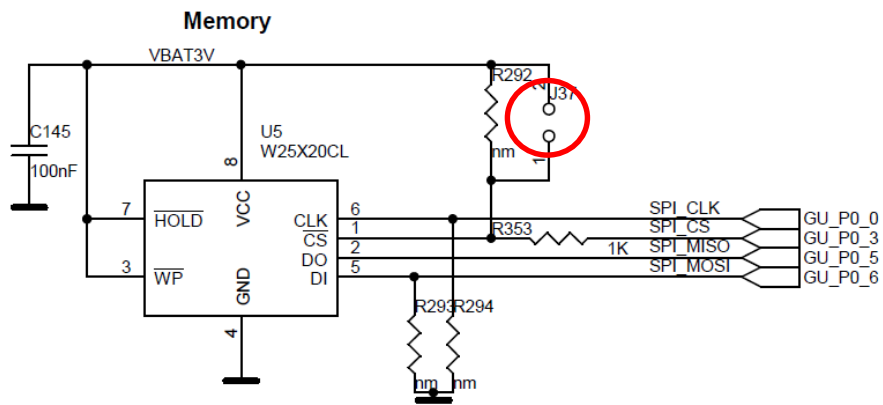

Figure 17: J37 - GU Programming Jumper Schematics



Figure 18: Location of J37 Jumper

5.9 PLT Functional Blocks

Figure 19 shows an overview of the PLT hardware functions. For detailed electrical schematics, see Appendix B.

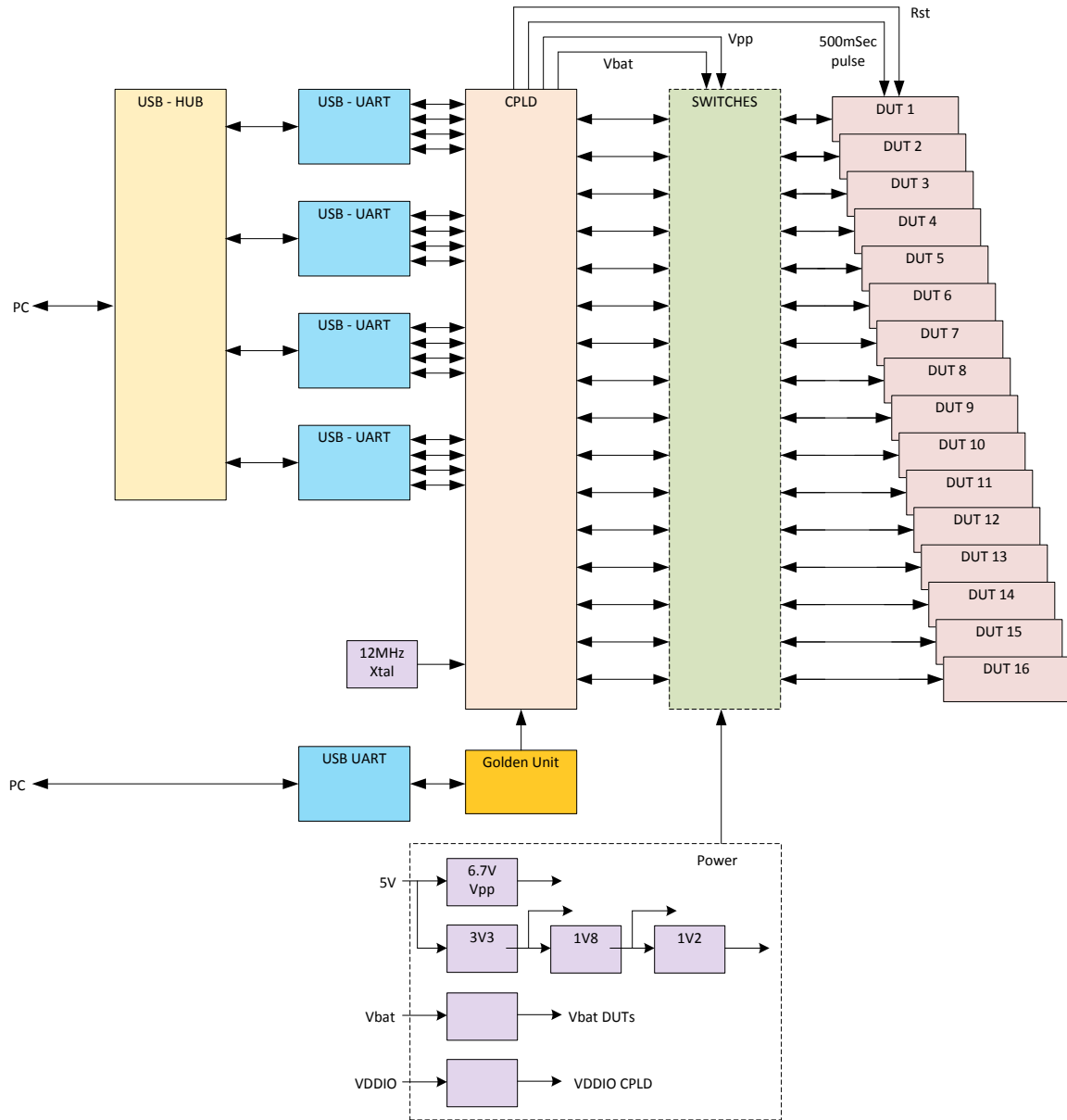

Figure 19: PLT Functional Blocks

6 Software

6.1 Introduction

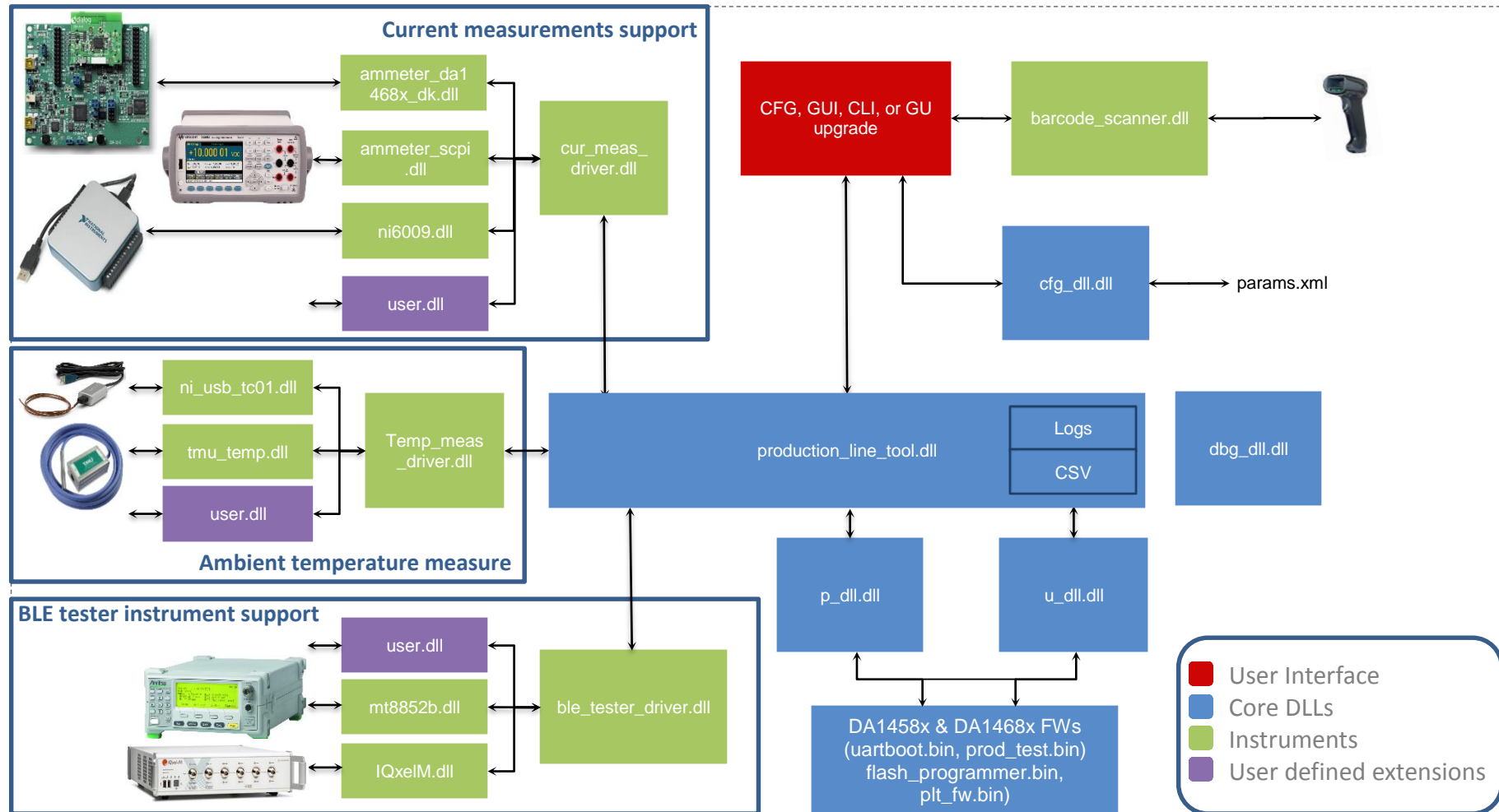

Figure 20: Production Line Tool Software Block Diagram

DA1458x/DA1468x Production Line Tool

The Production Line Tool software is a collection of software blocks that interact with each other, as shown in [Figure 20](#). Its main purpose is to communicate with the PLT hardware and the DUTs in order to run the production tests and perform memory operations. The software blocks can be arranged in four main groups:

- **Red blocks:** User Interface (UI) applications.
- **Blue blocks:** Core libraries.
- **Green blocks:** Instrument interface libraries.
- **Purple blocks:** User defined extensions.

Core libraries, instrument interface libraries and user-defined extensions are explained in detail in UM-B-040 [1]. The User Interface applications block consists of four application executables. For details, see section [Applications](#).

Table 5: PLT User Interface Application Executables

Short Name	File Name	Description
CFG PLT	DA1458x_DA1468x_CFG_PLT.exe	Configuration application. Load, edit and save the test parameters and the memory actions to be performed during device testing.
GUI PLT	DA1458x_DA1468x_GUI_PLT.exe	Graphical User Interface (GUI) application. Performs the actual device validation and memory programming. Provides a visual indication of the test results and access to the result logs.
CLI PLT	DA1458x_DA1468x_CLI_PLT.exe	The same as the GUI PLT but console based.
GU Upgrade	GU_fw_upgrade.exe	A Graphical User Interface (GUI) application, which is used to easily upgrade the firmware of the Golden Unit.

6.2 DA15101 support

DA15101 devices are supported from PLT version v4.2 and onwards. The DA15101 chipset is similar to the DA14683, thus the same tests are supported shown in [Table 15](#). In this user manual DA15101 chipsets are treated as DA14682/3, meaning that references to DA1468x apply to DA15101 chipsets as well.

6.3 Software Package Contents

The PLT software release package comes in a compressed folder DA1458x_DA1468x_PLT_v_X.zip, where 'X' represents the version number of the current PLT release.

[Figure 21](#) illustrates the main folders of the PLT software package. Folder `executables` holds all the executables and libraries needed for the PLT to run on a Windows 7/8/8.1/10 machine. Folder `source` contains the entire source code of the PLT, organized in a Visual Studio Express 2015 solution.

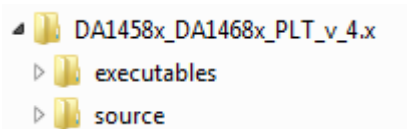

Figure 21: DA1458x/DA1468x PLT Software Package Contents

[Table 6](#) gives a short description of the files and folders contained in the `executables` directories.

DA1458x/DA1468x Production Line Tool

Table 6: Executables Folder Description

File or Folder	Description
ammeter_instr_plugins/	Contains the current measurement instrument DLLs, used during the current measurement tests.
ammeter_instr_plugins/ni6009.dll	This is the DLL for the NI-6009 DAQ [14] that could be used in the current measurements. The usage of this instrument for measuring the current requires an external shunt resistor and things complicate when the measurement switches from many DUTs to one DUT. We only recommend using this instrument if one DUT per run is tested.
ammeter_instr_plugins/ammeter_scpd.dll	This is the DLL for taking current measurements using a DMM that supports the standard SCPI commands. NI-VISA is also used for this purpose. Example DMM instruments are the Keysight 34401A [6], the Keithley 2000 [7] or the Keysight 34461A [15]. The PLT has been tested with all three instruments.
ammeter_instr_plugins/ammeter_da1468x_dk.dll	This is the DLL for taking current measurements using the current measurement module placed on the DA1468x pro motherboard.
binaries/	Contains the necessary firmware binaries. These are described in detail in <i>UM-B-040</i> [1]. Additionally, the SetupCode_Generator_680.exe application used in homekit products to create a specific hash key is included.
binaries/GU/prod_test_GU.bin	Contains the Golden Unit latest firmware binary. Users should better upgrade their PLT hardware with the GU firmware contained in this folder.
ble_tester_instr_plugins/	Contains the BLE tester instrument DLLs.
ble_tester_instr_plugins/mt8852b.dll	This is the DLL that performs the Direct Test Mode RF tests using the Anritsu MT8852B instrument [5]. Note: There is an issue in Anritsu MT8852B firmware version 4.20.000 and should be upgraded to the latest one. Latest MT8852B instrument firmware can be downloaded from the following link: https://www.anritsu.com/en-US/test-measurement/support/downloads?model=MT8852B
ble_tester_instr_plugins/IQxelM.dll	This is the DLL that performs the Direct Test Mode RF tests using the Litepoint IQxel-M instrument [13].
icons/	Contains pictures used by the PLT applications.
IQmeasure_3.1.2/	Contains specific Litepoint IQxel-M DLLs as released by Litepoint.
params/	Contains the configuration <code>params.xml</code> file, the XML schema <code>params.xsd</code> and a sample of BD address file named <code>bd_address.ini</code> .
params/custom_mem_data.csv	This is a sample CSV file to be used in the custom memory burn action. Users could edit this file and add their own specific memory data to be burned by the PLT. The PLT will match the entries in the CSV file using the BD addresses. The format of the file is explained later.
scripts/	Contains sample batch script files. User can select batch script files to be executed by the PLT before and after each test.

DA1458x/DA1468x Production Line Tool

File or Folder	Description
scripts/run_before_tests.cmd	An example script that copies and renames binaries from a directory to a folder required by the PLT when 'Different image per DUT' is selected. This folder is accessed by the PLT to read and burn different binary per DUT.
scripts/run_after_tests.cmd	An example script that moves all logs files, except the ones with the current date, to a specific folder.
temp_meas_instr_plugins/	Contains the temperature measurement instrument DLLs.
temp_meas_instr_plugins/ni_usb_tc01.dll	The ni_usb_tc01.dll is the DLL used to interface a NI USB TC01 [9] temperature sensor for temperature measurements.
temp_meas_instr_plugins/tmu_temp_sens.dll	The tmu_temp_sens.dll is the DLL used to interface a Papouch TMU sensor [7] for temperature measurements.
volt_meter_instr_plugins/	Contains the voltage meter instrument DLLs. These are used only in DA14681-00 silicon for ADC calibration purposes.
volt_meter_instr_plugins /volt_meter_scp.dll	The volt_meter_scp.dll is a DLL that implements basic interface with a DVM using SCPI commands through NI-VISA libraries and GPIB interface. Has been tested with Keithley 2000 [7] and Keysight 34401A [6].
DA1458x_DA1468x_CFG_PLT.exe	This is the configuration application. It is a graphical user interface application used to edit the PLT test configuration parameters, saved in an XML file, params.xml.
DA1458x_DA1468x_CLI_PLT.exe	This is the command line interface tool. It performs the production tests and memory programming through a console.
DA1458x_DA1468x_GUI_PLT.exe	This is the graphical user interface tool. It performs the production tests and memory programming through a graphical user interface.
GU_fw_upgrade.exe	This is the Golden Unit firmware upgrade application.
ammeter_driver.dll/.lib	This DLL loads and accesses all DMM instrument DLLs from inside the ammeter_instr_plugins. It acts as an intermediate layer between the prod_line_tool_dll and the instrument DLLs.
barcode_scanner.dll/.lib	This DLL receives BD addresses from a barcode scanner with USB to serial interface. Has been tested with Honeywell Xenon 1900 and the Motorola LS2208 barcode scan readers [10] [11].
ble_tester_driver.dll/.lib	This DLL loads and accesses all BLE tester instrument DLLs from inside ble_tester_instr_plugins folder.
cfg_dll.dll/.lib	This is the configuration parameter handling DLL. It can validate, load and save parameters from a given XML file.
dbg_dll.dll/.lib	The dbg_dll.dll file is a DLL used to print debug messages to a file or to a debug console.
ftd2xx.dll	This is the FTDI DLL. Used to hard reset the Golden Unit from the application whenever needed through an FTDI GPIO pin.
p_dll.dll/.lib	This is the production test DLL that performs device functional tests.

DA1458x/DA1468x Production Line Tool

File or Folder	Description
prod_line_tool_dll.dll/.lib	This is the core DLL. The heart of the system that performs the state machines for all tests and memory actions to be executed. It is responsible to log the results and notify the user interfaces about the current device test status.
temp_meas_driver.dll/.lib	This is the temperature measurement driver DLL. It loads and accesses all temperature measurement DLLs from inside the temp_meas_instr_plugins folder.
u_dll.dll/.lib	This is the DLL that performs the memory actions, like the memory programming, erasing, etc.
vc_redist.x86.exe/vc_redist.x64.exe	These are the Visual Studio 2015 Express redistributable packages for 32 and 64-bit machines. For installing these, users should agree to the license requirements described during the installation of any of these packages and also found here: https://www.visualstudio.com/license-terms/mt171551/ .
volt_meter_driver.dll/.lib	This is the voltage meter driver DLL. It loads and accesses all voltage meter DLLs from inside the volt_meter_instr_plugins folder.

6.4 Prerequisites

Before building and running the code, the packages indicated in [Table 7](#) should be installed on the PC. Some are required and others are optional depending on the tests or actions needed.

Table 7: Production Line Tool Prerequisites

Item	Optional	Description
Visual Studio 2015 Express	Yes	The IDE used to edit and debug the Production Line Tool. This is only required if users would like to edit the software.
vc_redist.x86.exe	No	Already described in Table 6 . Users should agree to the license requirements described during the installation of any of these packages and also found here: https://www.visualstudio.com/license-terms/mt171551/ .
MSXML6	No	Installed by default in Win 7/8/8.1/10.
.NET framework 4	No	Needed for the graphical user interface applications.
Latest FTDI drivers	No	Tested with FTDI v2.12.24, v2.12.26 and v2.12.28 drivers.
Honeywell Xenon 1900 drivers	Yes	Needed if the barcode scanner is going to be used for scanning the devices BD addresses and/or custom memory data. Other types of barcode scanners could also be used.
Motorola LS2208 drivers	Yes	Used if a barcode scanner is going to be used for scanning the device BD addresses and/or custom memory data.
NI-VISA 15.5	Yes	Used for optional instrument control, like BLE tester and voltage meter. NI-VISA 15.5 can be downloaded from http://www.ni.com/download/ni-visa-15.5/5846/en/
NI-488.2 15.5	Yes	Used for instrument control, like BLE tester and DMM. NI-488.2 15.5 can be downloaded from http://www.ni.com/download/ni-488.2-15.5/5859/en/
NI-DAQmx	Yes	Used for optional instrument control like temperature measurements using the NI USB TC01 sensor.

6.5 System Requirements

Table 8 contains the minimum system requirements for the PLT to operate.

Table 8: Minimum System Requirements

Item	Minimum Requirements	
Operating system	Windows 7/8/8.1/10	
CPU	Dual Core CPU	
Memory	1 GB RAM or larger. Each device log can reach up to 40 kB.	
Hard drive	For 100000 devices, at least 4 GB of available hard disk is required.	
Monitor resolution	1280 x 768 or higher	
Monitor DPI	Smaller - 100% = 96 DPI	Supported
	Medium - 125% = 120 DPI	Supported
	Larger - 150% = 144 DPI	Not supported

6.6 Limitations

Parallel control of multiple PLT hardware boards on the same PC is **not supported**.

However, by correctly setting up the system, two or more PLT hardware boards could be connected and controlled by multiple GUI PLT application instances on the same PC, but the tests should only be executed **sequentially**. The main reasons for this limitation are indicated below:

- The GU FT232 FTDI IC is programmed to have a special serial string, "DialogSemi" (see [Table 118](#)). This is used in the 'GU COM port find' PLT operation. This operation searches all PC connected FTDIs to find the serial string "DialogSemi". When found, it saves it as the GU COM port number to be used by the PLT. The 'GU COM port find' operation will open and lock, for a short period of time, all Windows COM ports, one by one, even the ones used by the other PLT hardware. If the second GUI PLT application instance is performing test operations at the same time and wants to open its DUT COM ports, the operation may fail.
- When the GUI PLT application starts the test operations, it performs a DUT COM port enumeration. During this process, the GU sets the CPLD in UART loopback mode. It opens all PC COM ports one by one and sends a specific word, while trying to see if it receives it back. During this process, other PLTs may need to work with 'their' DUT COM ports, which may happen to be currently used by the 'DUT COM port enumeration' process of the first PLT.
- GU hardware reset. In every PLT test run a GU HW reset is issued from the PLT software using a specific GU FTDI GPIO pin. In order to access the GU FTDI the FTDI API is used from `ftd2xx.dll`. To access the FTDI hardware and read the serial number through the FTDI `ftd2xx.dll` the `FT_Open` API is used on all PC COM ports, one by one. Since `FT_Open` is used in all PC COM ports, conflicts could arise if other PLTs would also like to use these COM ports.
- BD addresses handling. Usually, the PLT automatically sets the DUT BD addresses by increasing them one by one. Special care should be taken to work with multiple PLT hardware and software. Most probably, two different BD address files should be used for each PLT hardware.

DA1458x/DA1468x Production Line Tool

6.7 Building the Code

The PLT software release package contains not only application executables for directly performing the tests out of the box, but also the entire source code of the tools. This is organized in a Visual Studio 2015 Express solution.

To open the Visual Studio 2015 Express PLT source code solution the following steps should be executed (see Table 9).

Table 9: Opening the PLT Visual Studio 2015 Express Source Code Solution

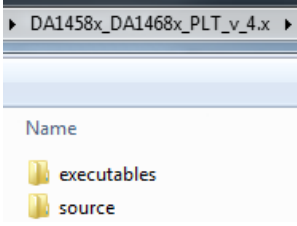
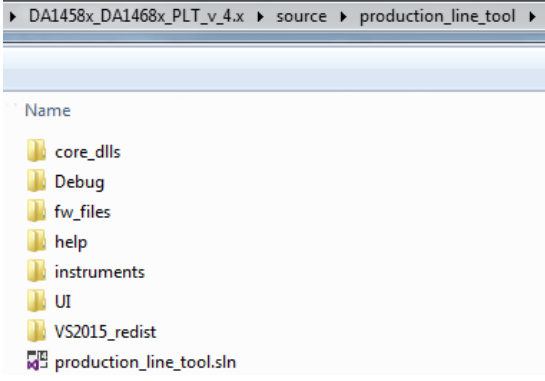
Step	Description
1	Download the latest PLT software package (e.g. DA1458x_DA1468x_PLT_v_4.x.zip)
2	<p>Extract the software package. The following two folders should exist.</p> 
3	<p>Go to folder 'source\production_line_tool'. The following files and folders should exist.</p> 

DA1458x/DA1468x Production Line Tool

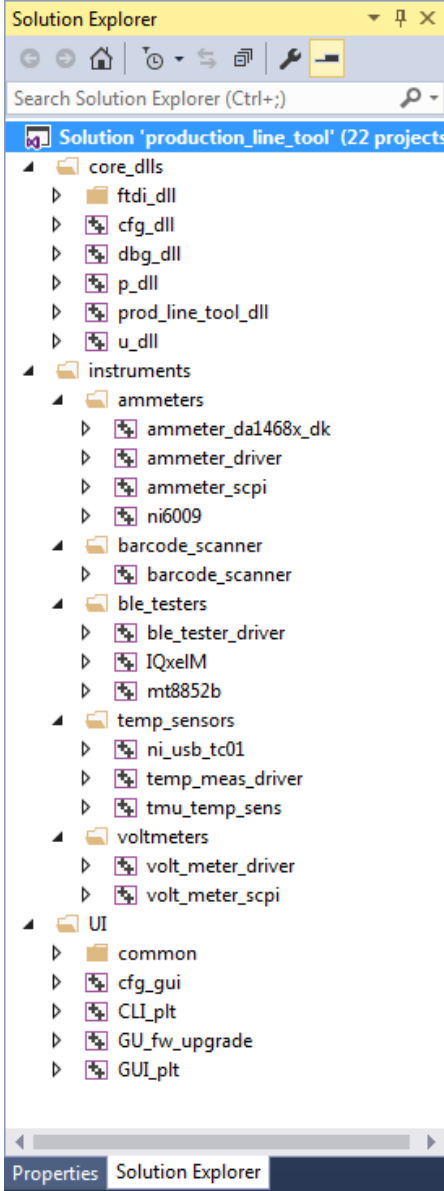
Step	Description
4	<p>Double click the <code>production_line_tool.sln</code> Visual Studio 2015 Express solution file. The Visual Studio 2015 Express application will start and the PLT Solution Explorer should be shown.</p>  <p>The screenshot shows the Solution Explorer window for the 'production_line_tool' solution. The tree view is expanded to show the following structure:</p> <ul style="list-style-type: none"> core_dlls <ul style="list-style-type: none"> ftdi_dll cfg_dll dbg_dll p_dll prod_line_tool_dll u_dll instruments <ul style="list-style-type: none"> ammeters <ul style="list-style-type: none"> ammeter_da1468x_dk ammeter_driver ammeter_scpi ni6009 barcode_scanner <ul style="list-style-type: none"> barcode_scanner ble_testers <ul style="list-style-type: none"> ble_tester_driver IQxelM mt8852b temp_sensors <ul style="list-style-type: none"> ni_usb_tc01 temp_meas_driver tmu_temp_sens voltmeters <ul style="list-style-type: none"> volt_meter_driver volt_meter_scpi UI <ul style="list-style-type: none"> common cfg_gui CLI_plt GU_fw_upgrade GUI_plt
5	<p>To build the code follow the process described in the <i>UM-B-040</i> document [1].</p> <p>Note: Some Visual Studio projects may need to be unloaded prior to building the code, as they require external libraries to be installed. Please read <i>UM-B-040</i> [1] for details.</p>

DA1458x/DA1468x Production Line Tool

6.8 Executing the Applications

To execute the Production Line Tool applications, the process described in the following tables should be followed.

Table 10: DA1458x_DA1468x_CFG_PLT.exe Application Execution

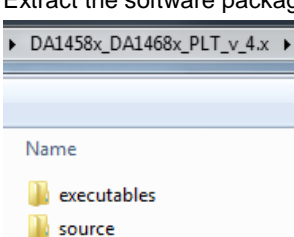
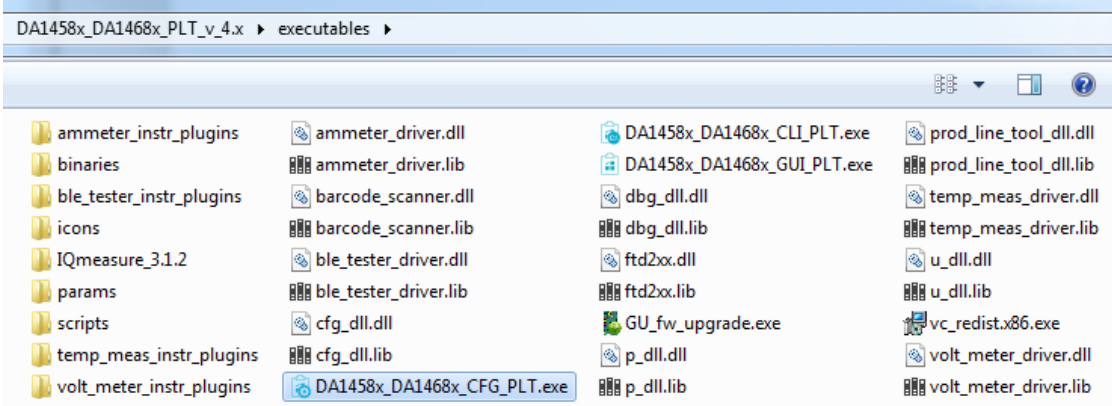
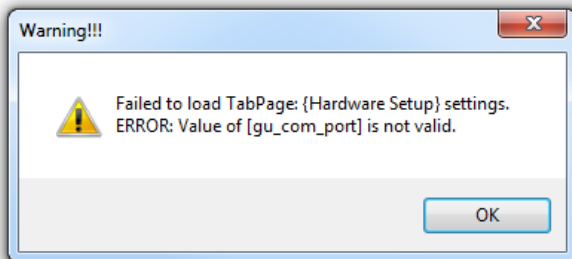
Step	Description
1	Download the latest PLT software package (e.g. DA1458x_DA1468x_PLT_v_4.x.zip).
2	<p>Extract the software package. The following two folders should exist.</p> 
3	<p>Go to folder 'executables'. This folder should contain the following files and sub-folders.</p> 
4	<p>Double click the DA1458x_DA1468x_CFG_PLT.exe application executable. Most probably, the following warning will be shown.</p>  <p>During start-up, the DA1458x_DA1468x_CFG_PLT.exe application loads the Hardware configuration parameters from the params.xml file. These parameters also contain the GU COM port. The default params.xml file has the GU COM port set to 4. If this COM port number does not exist in the PC, then this warning message will be shown. Therefore, this warning message indicates that the default GU COM port set in the params.xml file is not valid or that the GU USB cable is not connected to the PC. Press 'OK' if the warning message appears.</p>

DA1458x/DA1468x Production Line Tool

Step	Description
5	<p>The application will start and the initial <i>Hardware Setup</i> screen will be shown.</p>
6	<p>Connect the PLT HW to the PC. Connect the GU and the DUT USB cables to the PC. Check the Windows Device Manager that 17 new COM ports were found, 16 for the DUTs and 1 for the GU. The following picture is an example of a Device Manager COM ports for a PC that has the PLT connected.</p>

DA1458x/DA1468x Production Line Tool

Step	Description
7	<p>On the DA1458x_DA1468x_CFG_PLT.exe Hardware Setup initial screen press, Auto to automatically find the GU COM port among the 17 Windows enumerated COM ports. The Auto button will turn green if successful. Press Save* to save the new GU COM port in the params.xml file.</p>

Table 11: DA1458x_DA1468x_GUI_PLT.exe Application Execution

Step	Description
1	<p>To successfully start the DA1458x_DA1468x_GUI_PLT.exe application, the DA1458x_DA1468x_CFG_PLT.exe should be executed first in order to set up the system and perform the required tests. See Table 10.</p>
2	<p>Go to folder 'executables'. This folder should contain the following files and sub-folders. Double click on DA1458x_DA1468x_GUI_PLT.exe.</p>

DA1458x/DA1468x Production Line Tool

Step	Description
3	<p>Double click the DA1458x_DA1468x_GUI_PLT.exe application executable. The following initial screen will appear.</p>
4	<p>By clicking the keyboard spacebar, the START button will be pressed and the preconfigured tests and memory actions will start to be executed.</p>

Table 12: DA1458x_DA1468x_CLI_PLT.exe Application Execution

Step	Description
1	<p>To successfully start the DA1458x_DA1468x_CLI_PLT.exe application, the DA1458x_DA1468x_CFG_PLT.exe should be executed first, in order to set up the system and perform the required tests. See Table 10.</p>
2	<p>Go to folder 'executables'. This folder should contain the following files and sub-folders.</p>

DA1458x/DA1468x Production Line Tool

Step	Description
3	<p>Double click the DA1458x_DA1468x_CLI_PLT.exe application executable. The following initial screen will appear.</p>  <pre> DA1458x/DA1468x Production Line Tool v_4.x.0.x Command list: t <580/581/582/583/585/586/681-00/681-01> --> Select the IC for device under test. i <configuration file path> --> Import new configuration settings. All DLLs will be reinitialized with the new parameters. x --> Print the configuration parameters from the currently used XML file. a <FFFF-0000> --> Bitwise DUT activation. b <xx:xx:xx:xx:xx:xx> --> BD address to be used in the first active DUT of the next PLT test run. c <on/off> --> Graphics enable or disable. r <qspi/otp> --> DUT BD address read. v <qspi/otp> --> DUT BD address read and compare with given BD address. p --> DUT COM port enumeration. q --> GU COM port find. l --> GU check by blinking its LED. n <1FFF-0000> --> MSB-1 init. Next 16 bits are for bitwise DUT UBAT/UART set/reset. d <console/file> --> Enable Error and Info prints. Printed on file or in the console. q <otp/spi/eeprom/qspi> <address(hex)> <size(in bytes)> --> Read any field from any memory. s --> Start the tests. u <9600/19200/57600/115200/1000000> --> Run the uart check procedure. w <number of tests> --> Command used only for tool evaluation. Runs multiple tests, one after the other, without stopping. z --> Reset all parameters to their defaults. h --> Print this help. e --> Exit. > </pre>
4	Type 's' and then press Enter. The preconfigured tests and memory actions will start to be executed.

Table 13: GU_fw_upgrade.exe Application Execution

Step	Description
1	<p>GU_fw_upgrade.exe can be started by either opening the application from the executables folder or by pressing the 'Upgrade GU Firmware' button in the PLT Hardware Setup tab in DA1458x_DA1468x_CFG_PLT.exe.</p>
2	<p>Go to folder 'executables'. This folder should contain the following files and sub-folders.</p> 

DA1458x/DA1468x Production Line Tool

Step	Description
3	<p>Double click the <code>GU_fw_upgrade.exe</code> application executable. The following initial screen will appear.</p>  <p>Press next to continue.</p>
4	<p>Follow the instructions to guide you to successfully configure and select the Golden Unit. A detailed procedure is given in Chapter 7.5.</p>

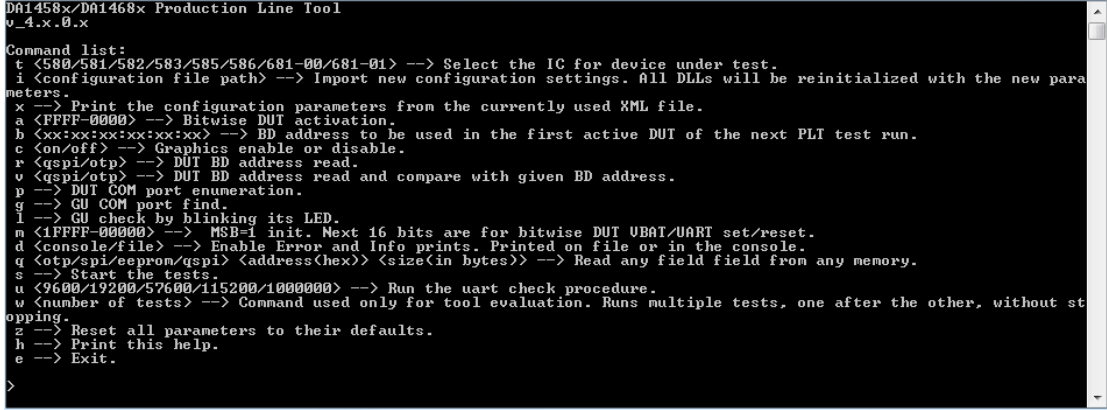
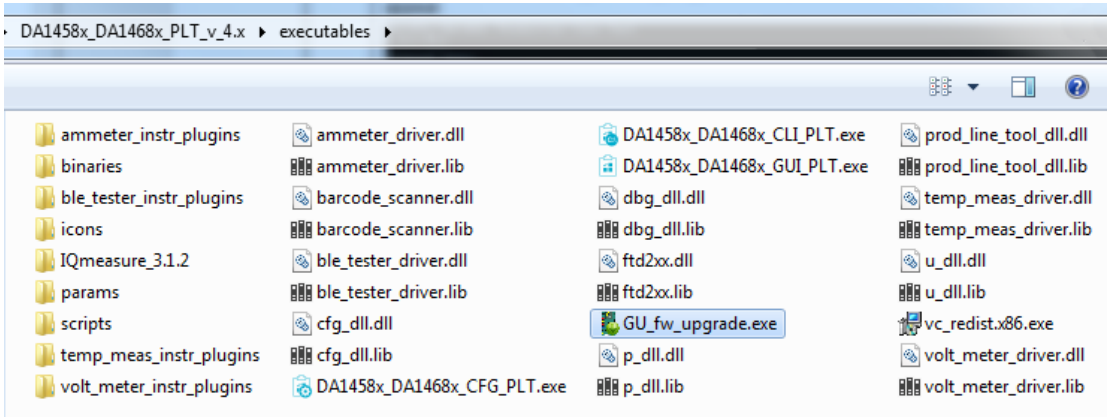
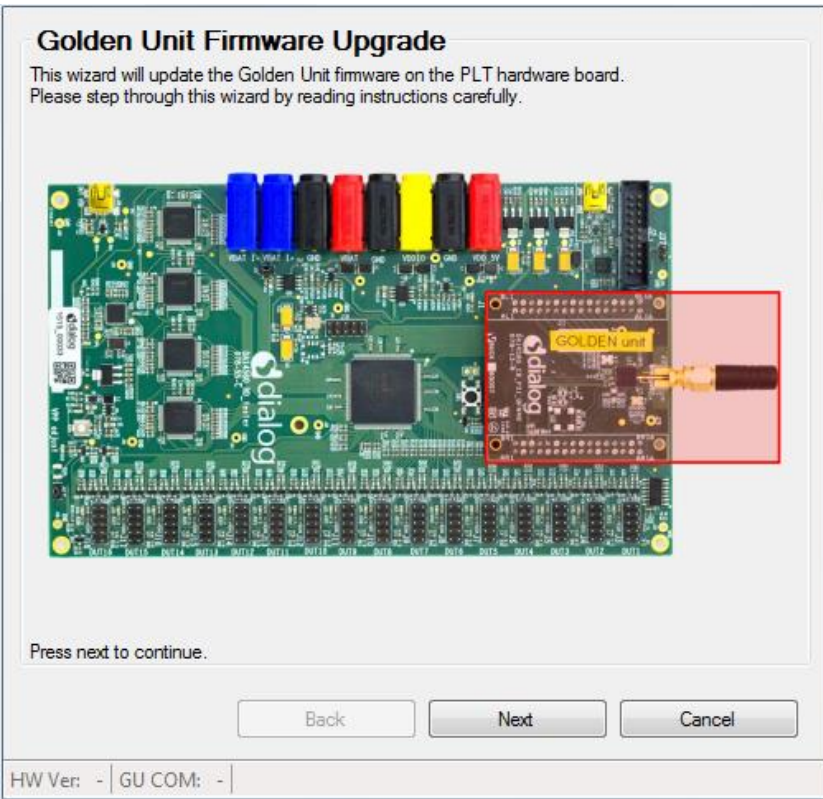
6.9 Test Sequence

This section describes the sequence of steps involved for the DA1458x and DA1468x device testing. It outlines all the steps the PLT follows to successfully test a device.

6.9.1 DA1458x Test Sequence

Table 14 describes each step the PLT undertakes for DA1458x devices. Some of the steps are optional and will only be executed if the equivalent actions are enabled in the configuration parameters. Additionally, some of the steps are supported only for specific DA1458x IC versions.

The entire test sequence for the DA1458x DUTs is shown in Figure 22.

Table 14: DA1458x Test Sequence

Step	Device	Action	Opt	Description
1	DA1458x	Statistics update	No	Update the total tests executed.
2	DA1458x	BD addresses	No	Update the BD addresses for all DUTs.
3	DA1458x	Configuration parameters	No	Configuration parameters are passed from the CLI or GUI to the <code>prod_line_tool_dll</code> . If any of the parameters is not valid, an error will occur.
4	DA1458x	Reset GU	No	Golden Unit hardware reset by controlling an FT232 pin.
5	DA1458x	Initialize CPLD	No	Set the CPLD to an initial known state.

DA1458x/DA1468x Production Line Tool

Step	Device	Action	Opt	Description
6	DA1458x	Check temperature sensor instrument	Yes	Check whether the temperature measurement instrument is online, only if the temperature measurement test is active.
7	DA1458x	Check BLE tester instrument	Yes	Check whether the BLE tester instrument is online, only if any of the BLE tester test operations is active.
8	DA1458x	Check ammeter instrument	Yes	Check whether the ammeter instrument is online, only if any of the current measurement tests is active.
9	DA1458x	Toggle GU LED	No	Toggle the GU red LED on the PLT hardware to indicate that the GU is alive.
10	DA1458x	Check DUT COM ports	No	Check whether the PLT has identified the DUT COM ports and if not run the automatic DUT COM port identification.
11	DA1458x	Temperature measure	Yes	If the temperature measurement test is active, take a measurement and log it to all DUT logs and in the CSV file.
12	DA1458x	Download prod_test_58x.bin	Yes	If any of the production tests is active (e.g. RF tests, XTAL trim, etc.) download the prod_test_58x.bin to the devices.
13	DA1458x	Open the devices COM ports and get the prod_test_58x.bin firmware version.	Yes	After prod_test_58x.bin has been downloaded to the DUTs, test commands can be sent to it. First, the Windows DUTs COM ports are opened. Then a command to get the prod_test_58x.bin firmware version is sent to the devices. If there is a problem in the firmware or in the device, then this is the first failure to happen. The FW version get action will fail.
14	DA1458x	GPIO Watchdog	Yes	If the GPIO watchdog option is enabled, the firmware will begin a periodic GPIO toggling during the whole production test procedure.
15	DA1458x	XTAL trim	Yes	Perform the XTAL trim procedure, if this is active.
16	DA1458x	XTAL trim OTP burn	Yes	If the 'Burn to OTP' option is selected in the CFG PLT, then the calculated XTAL trim value will be burned to the OTP Header.
17	DA1458x	UART resync	Yes	If the XTAL trim procedure was performed in the UART RX pin, then a special UART resync procedure takes place to resynchronize the device's UART RX path, as it may have entered into a baud rate error state due to the 500ms received XTAL trim pulse.
18	DA1458x	BLE scan HCI	Yes	If the Scan DUT Advertise test is active then perform a BLE scan test using HCI triggered advertisements.
19	DA1458x	BLE tester TX power	Yes	If the BLE tester TX Power test is active, then perform the test using the external BLE tester instrument.
20	DA1458x	BLE tester TX carrier offset	Yes	If the BLE tester TX carrier offset test is active, then perform the test using the external BLE tester instrument.
21	DA1458x	BLE tester TX modulation index	Yes	If the BLE tester TX modulation index test is active, then perform the test using the external BLE tester instrument.
22	DA1458x	BLE tester RSSI	Yes	If the BLE tester RSSI test is active, then perform the test using the external BLE tester instrument.
23	DA1458x	GU RSSI test	Yes	If the RSSI test using the GU as transmitter is active, then perform the test.

DA1458x/DA1468x Production Line Tool

Step	Device	Action	Opt	Description
24	DA1458x	GPIO/LED	Yes	Perform the GPIO/LED test, if the test is active.
25	DA1458x	GPIO connection test	Yes	Perform a GPIO continuity or voltage level test, if the test is active.
26	DA14582/5/6 only	Audio test	Yes	Perform the audio test, only for DA145482 and DA14585/6 devices and only if the particular test is enabled.
27	DA1458x	Sensor test	Yes	Perform the sensor tests only if these are enabled.
28	DA1458x	Custom test	Yes	Perform any active custom test.
29	DA1458x	External 32kHz	Yes	Check whether the external 32kHz crystal operates correctly.
30	DA1458x	Current measure	Yes	Perform any active current measurement test for peripherals.
31	DA1458x	Current measure	Yes	Perform the sleep current measurement.
32	DA1458x	Open COM port and perform Firmware download	Yes	If any memory action is active (e.g. SPI Flash burn, erase etc.), download the <code>flash_programmer.bin</code> to the devices.
33	DA1458x	Get <code>flash_programmer.bin</code> version.	Yes	After <code>flash_programmer.bin</code> has been downloaded, commands can be sent. A command to get the <code>flash_programmer.bin</code> firmware version is sent to the devices.
34	DA1458x	GPIO Watchdog	Yes	If the GPIO watchdog option is enabled, the firmware will begin a periodic GPIO toggling during the whole memory programming procedure.
35	DA1458x	Initialize SPI Flash memory	Yes	If any SPI flash operation is enabled, initialize memory.
36	DA1458x	SPI erase	Yes	Erase the SPI Flash, either entirely or part of it depending on the configuration.
37	DA1458x	SPI check empty	Yes	Depending on the configuration, check whether the SPI Flash is empty to verify the Flash erase procedure.
38	DA1458x	SPI image write	Yes	If enabled, write the SPI Flash with the customer image. If verify is enabled, the contents of the Flash will be read back and compared to the original image downloaded.
39	DA1458x	Initialize I2C EEPROM memory	Yes	If any EEPROM operation is enabled, initialize memory.
40	DA1458x	I2C EEPROM write	Yes	Write the I2C EEPROM with the customer image. If verify is enabled, the contents of the EEPROM will be read back and compared to the original image downloaded.
41	DA1458x	Custom memory data	Yes	Write custom memory data, taken from a barcode scanner, entered manually or through a CVS file.
42	DA1458x	OTP image write	Yes	Write the OTP image with the customer image. If verify is enabled, the contents of the OTP memory will be read back and compared to the original image downloaded.
43	DA1458x	OTP BD address write	Yes	If enabled, write the BD address into the OTP memory. If verify is enabled, the OTP BD address will be read back and compared to the original.

DA1458x/DA1468x Production Line Tool

Step	Device	Action	Opt	Description
44	DA1458x	OTP BD address read	Yes	If enabled, the BD address from the OTP will be read. The BD address will be printed in GUI or CLI application. An additional test can be enabled to compare the read BD address with the one supplied by the tool.
45	DA1458x	OTP header write	Yes	If enabled, the OTP header fields will be burned.
46	DA1458x	Memory read	Yes	Up to ten memory read tests can be performed with up to 256 bytes in length.
47	DA1458x	Scan test	Yes	If enabled, the GU will scan for device BLE advertisements. For the DUTs to be scanned a valid firmware has to be burned into the OTP, SPI Flash or EEPROM that sends BLE advertisements after power up. Additionally, the BD address should be burned into the OTP by the PLT. The PLT expects to find devices in the air with the BD addresses programmed by the same tool, so it can match the BD addresses returned by the GU.

DA1458x/DA1468x Production Line Tool

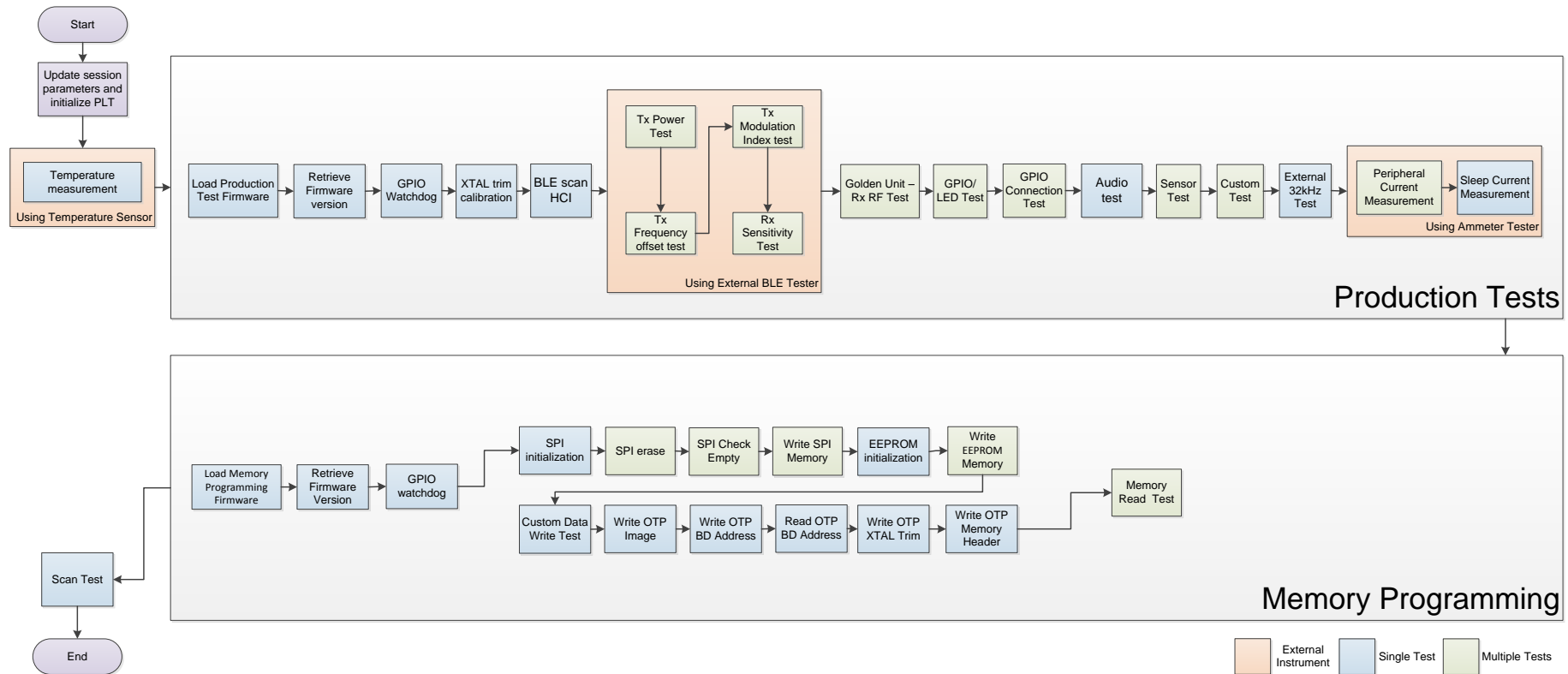

Figure 22: DA1458x Test Sequence

DA1458x/DA1468x Production Line Tool

6.9.2 DA1468x Test Sequence

Table 15 describes each step that the PLT undertakes to validate and program DA1468x based devices. Some of the steps are optional and will only be executed if the equivalent actions are enabled in the configuration parameters. Additionally, some of the steps are supported only for specific DA1468x IC versions.

The entire test sequence for the DA1468x DUTs is shown in Figure 23.

Table 15: DA1468x Test Sequence

Step	Device	Action	Opt	Description
1	DA1468x	Statistics update	No	Update the total tests executed.
2	DA1468x	BD addresses	No	Update the BD addresses for all DUTs.
3	DA1468x	Configuration parameters	No	Configuration parameters are passed from the CLI or GUI to the <code>prod_line_tool_dll</code> . If any of the parameters is not valid, an error will occur.
4	DA1468x	Reset GU	No	GU hardware reset by controlling an FT232 pin.
5	DA1468x	Initialize CPLD	No	The GU will set the CPLD to an initial known state.
6	DA1468x	Check temperature sensor instrument	Yes	Check whether the temperature measurement instrument is online, only if the temperature measurement test is active.
7	DA1468x	Check BLE tester instrument	Yes	Check whether the BLE tester instrument is online, only if any of the BLE tester test operations is active.
8	DA14681-00 only	Check voltage meter instrument	Yes	Check whether the voltage meter is online, only if the ADC gain calibration is active and only for DA14681-00 devices.
9	DA1468x	Check ammeter instrument	Yes	Check whether the ammeter instrument is online, only if any of the current measurement tests is active.
10	DA1468x	Toggle GU LED	No	Toggle the GU red LED on the PLT hardware to indicate that the GU is alive.
11	DA1468x	Check DUT COM ports	No	Check whether the PLT has identified the DUT COM ports and if not run the automatic DUT COM port identification.
12	DA1468x	Temperature measure	Yes	If the temperature measurement test is active, take a measurement and log it to all DUT logs and in the CSV file.
13	DA1468x	Download <code>uartboot_68x.bin</code>	Yes	If any of the production tests is active and the download through <code>uartboot</code> option is enabled, first the <code>uartboot_68x.bin</code> will be downloaded and then the production test firmware. In addition, if the GPIO watchdog option is enabled, then it will start the toggling after the <code>uartboot_68x.bin</code> is loaded and right before the production test download.
14	DA1468x	GPIO Watchdog	Yes	If the GPIO watchdog option is enabled, then firmware will start the toggling after the <code>uartboot_68x.bin</code> is loaded and right before the production test download.
15	DA1468x	Download <code>prod_test_68x.bin</code>	Yes	If any of the production tests is active (e.g. RF tests, XTAL trim, etc.) download the <code>prod_test_68x.bin</code> to the devices.

DA1458x/DA1468x Production Line Tool

Step	Device	Action	Opt	Description
16	DA1468x	Open the devices COM ports and get the prod_test_681_xx.bin firmware version	Yes	After prod_test_68x_xx.bin has been downloaded, commands can be sent to it. First, the Windows DUTs COM ports are opened. Then, a command to get the prod_test_68x_xx.bin firmware version is sent to the devices. If there is a problem in the firmware or in the device, then this is the first failure to happen. The FW version get action will fail.
17	DA1468x	GPIO Watchdog	Yes	If the GPIO watchdog option is enabled, the firmware will begin a periodic GPIO toggling during the whole production test procedure.
18	DA1468x-00 only	ADC gain calibration	Yes	If this option is enabled and if the device is based on a DA14681-00 IC, then the ADC gain calibration procedure takes place using an external voltage meter instrument.
19	DA1468x	XTAL trim	Yes	Perform the XTAL trim procedure, if this is active.
20	DA1468x	UART resync	Yes	If the XTAL trim procedure was performed in the UART RX pin, then a special UART resync procedure takes place to resynchronize the device's UART RX path as it may have entered in a baud rate error state due to the 500ms received XTAL trim pulse.
21	DA1468x	BLE scan HCI	Yes	If the Scan DUT Advertise test is active then perform a BLE scan test using HCI triggered advertisements.
22	DA1468x	BLE tester TX power	Yes	If the BLE tester TX Power test is active, then perform the test using the external BLE tester instrument.
23	DA1468x	BLE tester TX carrier offset	Yes	If the BLE tester TX carrier offset test is active, then perform the test using the external BLE tester instrument.
24	DA1468x	BLE tester TX modulation index	Yes	If the BLE tester TX modulation index test is active, then perform the test using the external BLE tester instrument.
25	DA1468x	BLE tester RSSI	Yes	If the BLE tester RSSI test is active, then perform the test using the external BLE tester instrument.
26	DA1468x	GU RSSI test	Yes	If the RSSI test using the GU as transmitter is active, then perform the test.
27	DA1468x	GPIO/LED	Yes	Perform the GPIO/LED test, if the test is active.
28	DA1468x	GPIO Connection test	Yes	Perform a GPIO continuity or voltage level test, if the test is active.
29	DA1468x	Sensor test	Yes	Perform the sensor tests only if these are enabled.
30	DA1468x	Custom test	Yes	Perform any active custom test.
31	DA1468x	External 32kHz	Yes	Check whether the external 32kHz crystal operates correctly.
32	DA1468x	Current measure	Yes	Perform any active current measurement test for peripherals.
33	DA1468x	Current measure	Yes	Perform the sleep current measurement.
34	DA1468x	Open COM port and download uartboot_68x.bin	Yes	If any of the memory actions is active (e.g. QSPI burn, QSPI erase, etc.) download the uartboot_68x.bin to the devices.
35	DA1468x	Get uartboot_68x.bin version.	Yes	After uartboot_68x.bin has been downloaded, commands can be sent to it. A command to get the uartboot_68x.bin firmware version is sent to the devices.

DA1458x/DA1468x Production Line Tool

Step	Device	Action	Opt	Description
36	DA1468x	GPIO Watchdog	Yes	If the GPIO watchdog option is enabled, the firmware will begin a periodic GPIO toggling during the whole memory programming procedure.
37	DA1468x	QSPI memory initialization	Yes	If any QSPI operation is enabled, initialize memory.
38	DA1468x	QSPI erase	Yes	Erase the QSPI, either the entire or part of it depending on the configuration.
39	DA1468x	QSPI check empty	Yes	Depending on the configuration, check whether the QSPI is empty to verify the QSPI erase procedure.
40	DA1468x	QSPI image write	Yes	If enabled, write the QSPI with the customer image. If verify is enabled, the contents of the QSPI will be read back and compared to the original image downloaded.
41	DA1468x	QSPI BD address write	Yes	If enabled, the device BD address is programmed to a specific QSPI flash address.
42	DA1468x	QSPI BD address read	Yes	If enabled, the PLT will read the BD address field from the QSPI. This will be printed in the GUI, CLI screen and in the device logs. An additional test can be enabled to compare the read BD address to the one supplied by the tool.
43	DA1468x	QSPI XTAL trim write	Yes	If enabled, the XTAL trim value calculated during the XTAL trim calibration procedure will be burned into the QSPI flash.
44	DA1468x-00 only	QSPI ADC gain calibration write	Yes	If enabled, the ADC gain calibration value calculated during the calibration procedure will be burned into the QSPI flash.
45	DA1468x	Custom memory data	Yes	Write custom memory data, taken from a barcode scanner, entered manually or through a CVS file.
46	DA1468x	OTP image write	Yes	Write the OTP image with the customer image. If verify is enabled, the contents of the OTP memory will be read back and compared to the original image downloaded.
47	DA1468x	OTP BD address write	Yes	If enabled, write the BD address into the OTP memory. If verify is enabled, the OTP BD address will be read back and compared to the original.
48	DA1468x	OTP BD address read	Yes	If enabled, the PLT will read the BD address field from the OTP. This will be printed in the GUI, CLI screen and in the device logs. An additional test can be enabled to compare the read BD address to the one supplied by the tool.
49	DA1468x	OTP XTAL trim write	Yes	If enabled, the XTAL trim value calculated during the XTAL trim calibration procedure will be burned into the OTP TCS header.
50	DA1468x-00 only	OTP ADC gain calibration write	Yes	If enabled, the ADC gain calibration value calculated during the calibration procedure will be burned into the OTP TCS header.
51	DA1468x	OTP header write	Yes	If enabled, the OTP header fields will be burned.
52	DA1468x	Memory read	Yes	Up to 10 memory read tests can be performed with up to 256 bytes in length.

DA1458x/DA1468x Production Line Tool

Step	Device	Action	Opt	Description
53	DA1468x	Scan test	Yes	<p>If enabled, the GU will scan for device BLE advertisements. For the DUTs to be scanned a valid firmware has to be burned into the OTP or QSPI flash that sends BLE advertisements after power up. Additionally, the BD address should be burned into the OTP or the QSPI by the PLT.</p> <p>The PLT expects to find devices in the air with the BD addresses programmed by the same tool, so it can match the BD addresses returned by the GU.</p>

DA1458x/DA1468x Production Line Tool

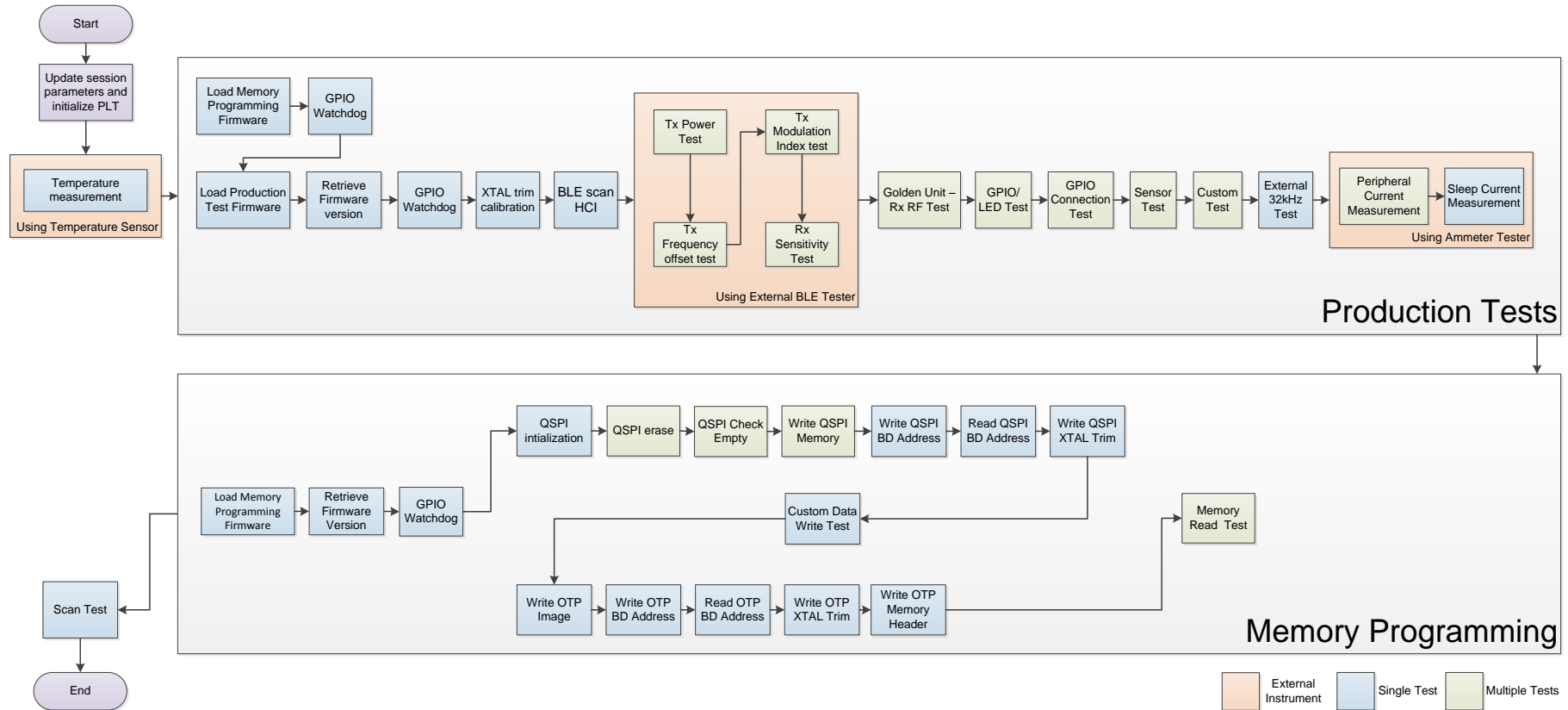

Figure 23: DA1468x Test Sequence

6.10 VBAT/Reset Signals Operation

The following chapter describes the PLT hardware VBAT and Reset signal operation during the DUT Test Sequence.

There are three different modes available to power and reset the DUTs using a combination of the PLT VBAT and Reset lines. These are described next.

6.10.1 VBAT Only

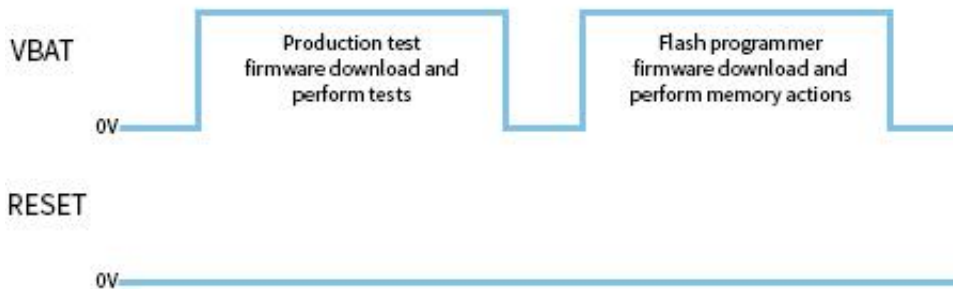

Figure 24: VBAT only

In this mode only the VBAT line is used, as shown in Figure 24. Only the VBAT signal from the PLT hardware board to the DUT should be connected. The Reset signal is not driven. The DUTs are powered independently from their VBAT lines connected to the PLT HW and when reset is needed, the PLT software toggles the VBAT line low in order to perform a POR to each device.

Battery powered DUTs or DUTs with an external power supply are not supported in this mode. PLT to DUT VBAT line connection is mandatory. PLT Reset line connection is not required.

Firmware download

When the firmware download procedure begins, the PLT VBAT line will power the DUTs and the UART connections will open. This will result to a POR for all active devices. The POR will activate the DUTs UART booting procedure and the PLT software will be able to download the test firmware.

If there are devices that failed the test firmware download procedure, the PLT will perform a VBAT POR to retry the firmware download procedure only for those that failed. During the extra attempts to download firmware to the failed devices, the VBAT lines of the devices that succeeded will remain active. After three retry attempts, the PLT VBAT lines will remain active only for the devices that have succeeded. The retry operation and the amount of retries can be configured by the user. Check 7.2.3.2 for more details.

When the production testing has finished the above procedure will be repeated for the memory programming, as a different firmware needs to be downloaded to the DUTs.

Current measurement

Since the DUTs will be powered through the PLT HW using the VBAT line, the Current Measurement Test for the DA14580/1/2/3/5/6 and the Current Measurement Test for the DA14681/2/3 are supported as described in the Current Measurements chapter.

DA1458x/DA1468x Production Line Tool

6.10.2 VBAT On with Reset

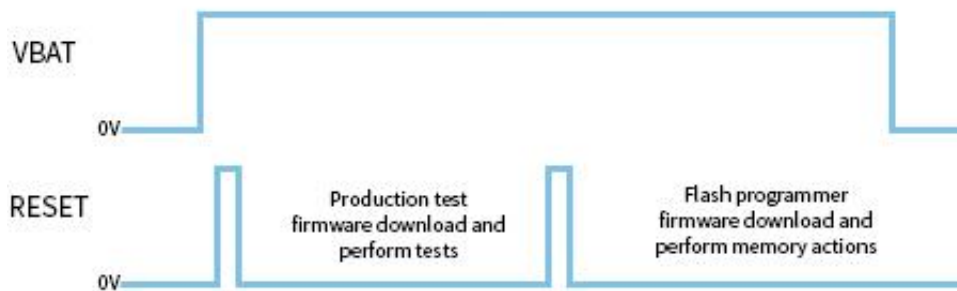

Figure 25: VBAT On with Reset

In this mode the reset of the DUTs will be performed by the PLT Reset line as shown in [Figure 25](#). During this mode, the PLT VBAT line continuously provides power to the DUTs and the DUTs are reset using the PLT Reset line.

Power supply can be provided to the DUTs if the PLT VBAT line is connected to the DUTs. However, for battery powered DUTs or for DUTs with an external power supply VBAT should not be connected. For such devices, only the connection to the PLT Reset line is mandatory.

Firmware download

When the firmware download procedure begins, the PLT will reset the DUTs using the PLT Reset line. The VBAT line is already active and remains active for the entire PLT test and memory programming procedure. If there are devices that failed to download firmware, the PLT will reset all the DUTs again and retry to download firmware to all of them even if these have succeeded. This is different approach from the [VBAT Only](#) procedure, since the Reset line is a single hardware line that cannot be differently controlled for each DUT, as opposed to the VBAT lines. The retry operation and the amount of retries can be configured by the user. Check [7.2.3.2](#) for more details.

When the production testing has finished, the above procedure will be repeated for the memory programming, as a different firmware needs to be downloaded to the DUTs.

Current measurement

If the DUTs are powered through the PLT HW using the VBAT line, or if they are powered using a single common line from an external power supply, the [Current Measurement Test](#) for the DA14580/1/2/3/5/6 and the [Current Measurement Test](#) for the DA14681/2/3 are supported as described in the [Current Measurements](#) chapter. If the DUTs are powered independently or have their own power supply (e.g. battery) then the current measurement tests are not supported.

6.10.3 VBAT as Reset

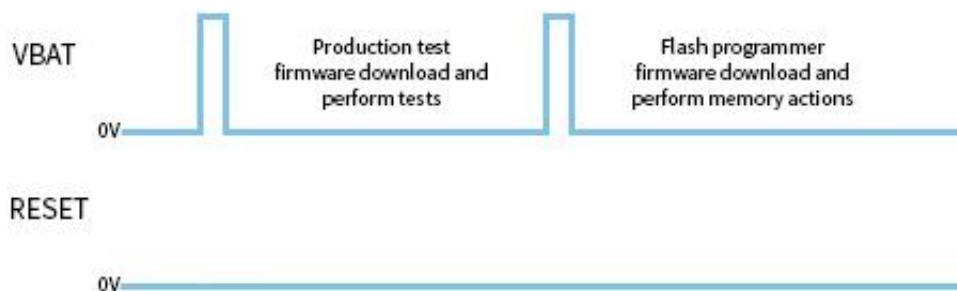

Figure 26: VBAT as Reset

In this mode, the reset of the DUTs will be performed using the PLT VBAT line as shown in [Figure 26](#). Each DUT can be reset independently using the VBAT lines. This mode has advantage over

DA1458x/DA1468x Production Line Tool

VBAT On with Reset since VBAT lines can independently be controlled as opposed to the PLT Reset line.

This mode supports only devices that are battery powered or have an external power supply and are already powered on. PLT VBAT line connection is mandatory and it must be connected to the DUT reset pin. The PLT Reset line connection is not used.

Note: When using this mode, the PLT VPP signal used for programming the OTP memory (OTP header and burning the XTAL Trim to OTP during production testing for the DA14580/1/2/3 devices) is not supported. An external VPP supply (as described in [Table 2](#)) should be provided when using this mode.

Firmware download

When the firmware download procedure begins, the UART connections will open and the PLT VBAT lines will be used to reset the DUTs.

If there are devices that failed the firmware download procedure, the PLT will perform a reset (using the VBAT line of each DUT) to retry for those DUTs that failed. After three attempts, the UART connections will remain on only for the devices that have firmware loaded. The retry operation and the amount of retries can be configured by the user. Check [7.2.3.2](#) for more details.

When the production testing has finished, the above procedure will be repeated for the memory programming, as a different firmware needs to be downloaded to the DUTs.

Current measurement

If the DUTs are powered using a single common line from an external power supply, then the [Current Measurement Test](#) for the DA14580/1/2/3/5/6 and the [Current Measurement Test](#) for the DA14681/2/3 are supported as described in [Current Measurements](#). If the DUTs are powered independently or have their own power supply (e.g. battery) then the current measurement tests are not supported.

6.11 Custom Memory Data

The following chapter describes the PLT 'Custom Memory Data' configuration and programming procedure.

The PLT supports programming custom user data of any size up to 256 bytes, to any memory and from any start address. Custom data can be entered to the PLT by the three input methods described in [Table 16](#).

Table 16: Custom Memory Data Input Modes

Input Modes	Description
Barcode scanner	Prior of starting the PLT tests, before pressing the START button in the PLT GUI, users can use a barcode scanner to enter custom memory data, different for each DUT. A new GUI screen is used to scan DUT barcodes and save the barcode scanned data to the PLT. The PLT will then burn these data to the user specified memory and address. Duplicate scan data protection can be enabled to protect scanning same data for different DUTs in the same test.
CSV file	Users can provide a path to a CSV file that will contain the custom memory data for each DUT. The format of the CSV file is specific and is provided in Custom data CSV file format .
Manual	Users can manually edit the custom memory data prior of each PLT test run. The edit can be done in the PLT GUI or in the params.xml file using an external application or script. If different data per DUT is required then the update of the custom memory data should be done before every PLT test run.

Chapter [Custom Memory Data](#) explains in detail the various configuration parameters of the 'Custom Memory Data' programming PLT feature.

DA1458x/DA1468x Production Line Tool

6.11.1 Homekit Hash Setup Code

The PLT supports the hashing and programming of homekit setup codes. This feature is only supported for DA14681/2/3 DUTs and can be enabled in the [Custom Memory Data](#) test using the `Homekit binary generator` option. For this to work users should input to the PLT a specific format of the setup code and device serial number. The format should be as described in [Table 17](#).

Table 17: Homekit Setup Code Format

Homekit Setup Code format	Description		
XXXXXXXXYYYYAAZZZZZZZZZZZZC	Part	Length	Description
	XXXXXXXX	8 digit	Homekit setup code without the dashes.
	YYYY	4 characters	Setup ID
	AA	1 byte	Accessory category
	ZZZZZZZZZZZZ	12 characters	Serial number
	C	1 character	Checksum of the previous characters
	Example: Consider a device with setup code 50867478, setup id 7OSX, accessory category 03 and serial number 112233445566. The input to the PLT should be given as 508674787OSX03112233445566R. The final character 'R' is the checksum of the previous characters. The algorithm of the checksum is given in Table 18 .		

The homekit setup code characters can be taken from either input mode described in [Table 16](#). The PLT will read the data and will apply it as input argument to the `SetupCode_Generator_680.exe` application found under the `binaries` folder. The `SetupCode_Generator_680.exe` application will create, in the same `binaries` folder, a binary image with the name `XXXXXXXXYYYYAAZZZZZZZZZZZZ.bin`. The PLT will burn this file to the DUT memory and start address that the user has configured.

DA1458x/DA1468x Production Line Tool
Table 18: Homekit Setup Code Checksum Algorithm**Homekit Setup Code Checksum Algorithm**

```

const char checkCharList[] = "0123456789ABCDEFGHIJKLMNOPQRSTUVWXYZ";
/**
 *
 * @brief Homekit specific setup code and serial number checksum check function.
 * This checksum algorithm is similar to EAN, ILN and NVE but with alphanumeric instead of numbers
 *
 * @param[in] *inString          The string to check its checksum.
 * @param[in] *inLength          The length of the string.
 *
 * @return The checksum character.
 */
char hmkt_setupcode_chksm(const char *inString, int inLength)
{
    char check = 0;
    int index = 0;
    unsigned int sum = 0;
    const char *characters = inString;

    for (index=0; index<inLength && characters[index]!=0; index++) {
        if ((index % 2) == 0)
            sum += characters[index];
        else sum += characters[index] * 3;
    }

    sum = sum % 36;

    if (sum != 0)
        sum = 36 - sum;

    check = checkCharList[sum];

    return check;
}

```

DA1458x/DA1468x Production Line Tool

Figure 27 shows an example of a CSV file targeted for DA14580 DUTs. In this particular example the CSV file contains information for DUTs with BD addresses 80:EA:CA:80:00:01 to 80:EA:CA:80:00:13. For BD addresses 80:EA:CA:80:00:04-05 there are three tests and two for the rest.

The first operation, which is similar for all BD addresses with only the Data field to be different, is to write in the OTP Header memory of the DA14580 DUTs five bytes, in OTP address 0x47F54 (OTP Customer field).

The second operation is identical for all DUTs. It is configured to write into the SPI flash address 0x8000 10 bytes (0x112233445566778899AA).

Finally, the third operation only applies for BD addresses 80:EA:CA:80:00:04 and 80:EA:CA:80:00:05. This will write 256 bytes of data in address 0x9000 of the SPI flash memory.

6.12 Golden Unit Scan Test

This section describes the PLT scan test procedure using the Golden Unit as scanner device.

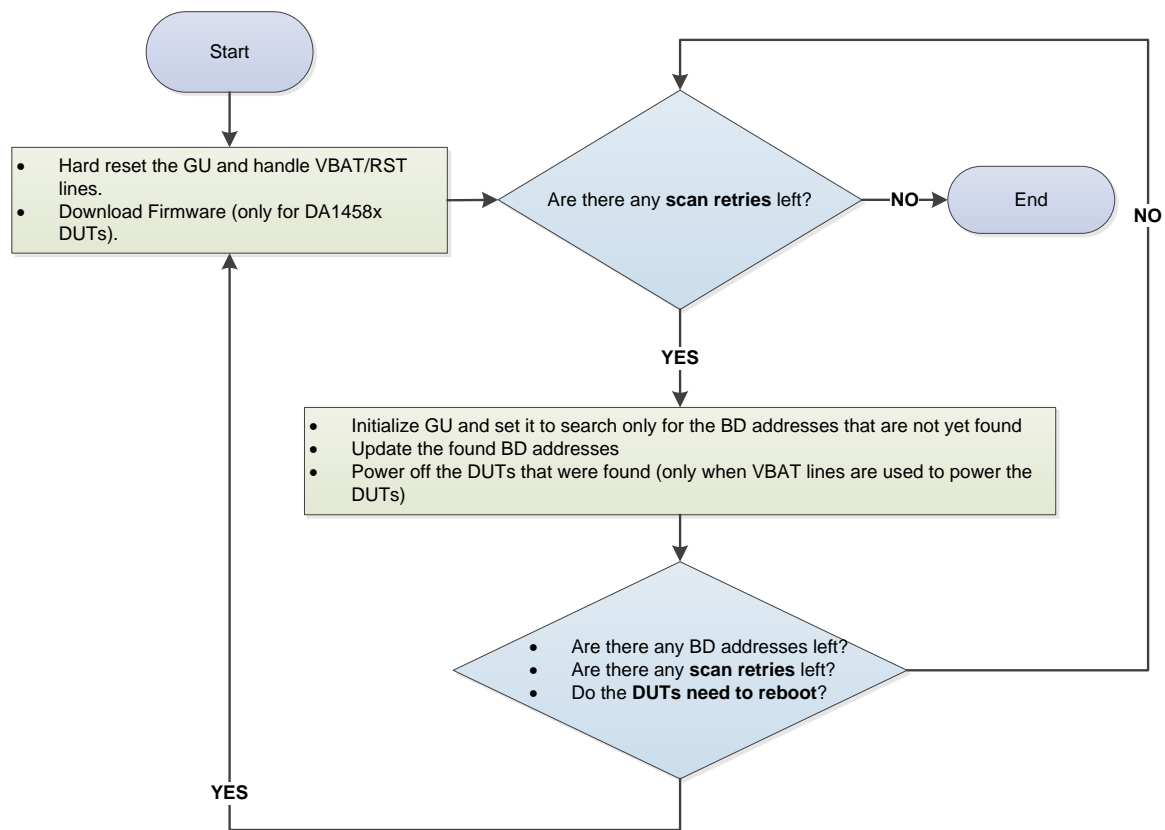

Figure 28: Golden Unit Scan Test

User can set various scan properties to adjust the Scan test procedure. The available properties that apply to the DA1458x devices are described Table 64 and for the DA1468x devices in Table 96.

Figure 28 shows the scan sequence. First, the Golden Unit and the DUTs are reset. At this stage, if the *Firmware load enable* is active (option is available only in DA1458x DUTs) the PLT will download the selected firmware. Then, the GU will begin scanning for the BD addresses of all active DUTs. After each scan cycle, the already found BD addresses are removed from the search list of the GU and the appropriate DUTs will be powered off. This procedure will continue until the retries have reached the *Scan retries* set by the user. The PLT will reset the GU after a specific number or retries,

DA1458x/DA1468x Production Line Tool

given in *DUT reboot* option. Finally, the parameters *DUT reboot time* and *DUT reboot difference* set the DUT time needed to perform a POR with a small delay between the DUTs if needed.

Enable

Scan retries

DUT reboot

DUT reboot difference

DUT reboot time

Firmware load enable

Firmware path

Figure 29: Golden Unit Scan Test Example Parameters

Figure 29 shows an example for DA14580 DUT connected with *VBAT only* mode as described in [VBAT/Reset Signals Operation](#). For this example, the following steps will be executed.

- Reset the GU in order to be in a clean state, power off the DUTs and wait for 2500ms (DUT reboot time). Power on and load `prox_reporter_580.bin` firmware to each DUT with a 37ms time difference between them.
- Execute three GU scan procedures. After each scan procedure is finished, power off the found DUTs.
- Again, reset the GU, power off the DUTs and wait for 2500ms (DUT reboot time). Power on and load `prox_reporter_580.bin` firmware to each DUT with a 37ms time difference between them.
- Continue with another three GU scan procedures and after each scan procedure power off the found DUTs.

DA1458x/DA1468x Production Line Tool

6.13 Creating PLT Firmware Files

For the PLT to successfully operate, various firmware files are used based on the device type (GU or DUT), the chipset flavor (DA14580/1/2/3/5/6 or DA14680/1/2/3) or the purpose of the firmware (different firmware for production tests and for memory programming).

All these firmware files are kept under the `binaries` folder in the PLT software package, as shown in [Figure 30](#). In order to create these firmware files, the SDK packages should be downloaded from the customer portal and apply the source code patches located under the `fw_files` folder in the PLT software package as shown in [Figure 31](#).

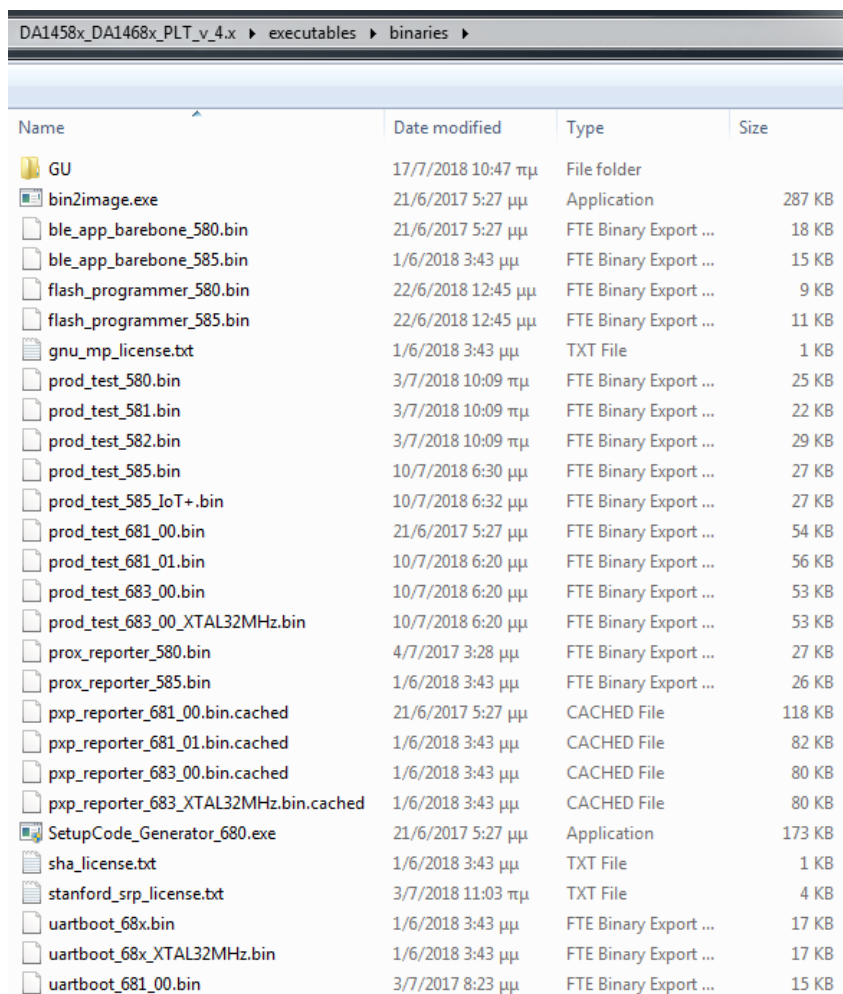

Name	Date modified	Type	Size
GU	17/7/2018 10:47 πμ	File folder	
bin2image.exe	21/6/2017 5:27 μμ	Application	287 KB
ble_app_barebone_580.bin	21/6/2017 5:27 μμ	FTE Binary Export ...	18 KB
ble_app_barebone_585.bin	1/6/2018 3:43 μμ	FTE Binary Export ...	15 KB
flash_programmer_580.bin	22/6/2018 12:45 μμ	FTE Binary Export ...	9 KB
flash_programmer_585.bin	22/6/2018 12:45 μμ	FTE Binary Export ...	11 KB
gnu_mp_license.txt	1/6/2018 3:43 μμ	TXT File	1 KB
prod_test_580.bin	3/7/2018 10:09 πμ	FTE Binary Export ...	25 KB
prod_test_581.bin	3/7/2018 10:09 πμ	FTE Binary Export ...	22 KB
prod_test_582.bin	3/7/2018 10:09 πμ	FTE Binary Export ...	29 KB
prod_test_585.bin	10/7/2018 6:30 μμ	FTE Binary Export ...	27 KB
prod_test_585_IoT+.bin	10/7/2018 6:32 μμ	FTE Binary Export ...	27 KB
prod_test_681_00.bin	21/6/2017 5:27 μμ	FTE Binary Export ...	54 KB
prod_test_681_01.bin	10/7/2018 6:20 μμ	FTE Binary Export ...	56 KB
prod_test_683_00.bin	10/7/2018 6:20 μμ	FTE Binary Export ...	53 KB
prod_test_683_00_XTAL32MHz.bin	10/7/2018 6:20 μμ	FTE Binary Export ...	53 KB
prox_reporter_580.bin	4/7/2017 3:28 μμ	FTE Binary Export ...	27 KB
prox_reporter_585.bin	1/6/2018 3:43 μμ	FTE Binary Export ...	26 KB
pxp_reporter_681_00.bin.cached	21/6/2017 5:27 μμ	CACHED File	118 KB
pxp_reporter_681_01.bin.cached	1/6/2018 3:43 μμ	CACHED File	82 KB
pxp_reporter_683_00.bin.cached	1/6/2018 3:43 μμ	CACHED File	80 KB
pxp_reporter_683_XTAL32MHz.bin.cached	1/6/2018 3:43 μμ	CACHED File	80 KB
SetupCode_Generator_680.exe	21/6/2017 5:27 μμ	Application	173 KB
sha_license.txt	1/6/2018 3:43 μμ	TXT File	1 KB
stanford_srp_license.txt	3/7/2018 11:03 πμ	TXT File	4 KB
uartboot_68x.bin	1/6/2018 3:43 μμ	FTE Binary Export ...	17 KB
uartboot_68x_XTAL32MHz.bin	1/6/2018 3:43 μμ	FTE Binary Export ...	17 KB
uartboot_681_00.bin	3/7/2017 8:23 μμ	FTE Binary Export ...	15 KB

Figure 30: Binaries

The source code patches maintain the folder structure of the SDK they are targeting, in order to apply the source code patch using a simple copy and replace to the files needed. After patching, the projects contain all the necessary changes and the same firmware files can be built as those in the `binaries` folder of the PLT software package.

The '`fw_files`' folder has two main categories. Firmware targeted for the GU and for the DUTs. Under each category there is a folder indicating the IC target and the SDK used.

DA1458x/DA1468x Production Line Tool

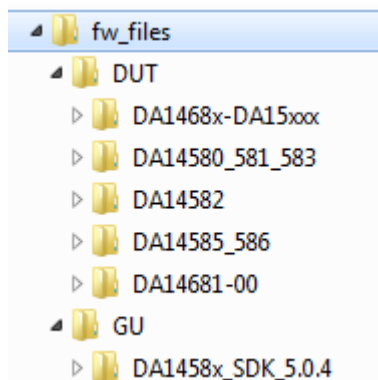

Figure 31: Folder Contents of 'fw_files'

Applying a source code patch for each one of the binaries is described below.

Golden Unit Firmware

The Golden Unit is a DA14580 device. A modified version of the `prod_test_580.bin` firmware is used.

This patch contains all the changes needed to re-create the following firmware.

- `prod_test_GU.bin`

In order to re-create the exact source code of the `prod_test_GU.bin` firmware:

1. Use a clean copy of the `DA1458x_SDK_5.0.4` SDK from the customer portal.
2. Copy the contents of the `'..\fw_files\GU\DA1458x_SDK_5.0.4\DA1458x_SDK\5.0.4'` folder to the default SDK.
3. The Keil v5 project file of the `prod_test_GU.bin` is the `'prod_test.uvprojx'` under the folder `'\5.0.4\projects\target_apps\prod_test\prod_test\Keil_5'`.

DA14580/1/2/3 Firmware

This patch contains all the changes needed to re-creates the following firmware:

- `prod_test_580.bin`
- `prod_test_581.bin`
- `flash_programmer_580.bin`
- `prox_reporter_580.bin`
- `ble_app_barebone_580.bin`

Note: Due to functional differences between the DA14580 and DA14581 chips, a different production test firmware for each IC is needed.

Note: Because DA14582 supports the audio test, another patch must be applied over this, in order to create a production test firmware that supports audio test for the DA14582 DUTs, as described later.

Note: The PLT uses the same firmware for DA14583 and DA14580, so there is no need for a different production test binary.

In order to re-create the exact source code of the above firmware:

1. Use a clean copy of the `DA1458x_SDK_5.0.4` SDK from the customer portal.
2. Copy the contents of the `'..\fw_files\DUT\DA14580_581_583\DA1458x_SDK_5.0.4\DA1458x_SDK\5.0.4'` folder to the default SDK.

DA1458x/DA1468x Production Line Tool

3. The Keil v5 project file of the `prod_test_580.bin` and `prod_test_581.bin` is the `'prod_test.uvprojx'` under the folder `'\5.0.4\projects\target_apps\prod_test\prod_test\Keil_5\'`. To select between the DA14580 and DA14581 there is a "Select Target" option next to the project properties.
4. The Keil v5 project file of the `flash_programmer_580.bin` is the `'programmer.uvprojx'` under the folder `'\5.0.4\utilities\flash_programmer\'`. Make sure that `'programmer_uart'` option is selected under "Select Target".
5. The Keil v5 project file of the `prox_reporter_580.bin` is the `'prox_reporter.uvprojx'` under the folder `'\5.0.4\projects\target_apps\ble_examples\prox_reporter\Keil_5\'`.
6. The Keil v5 project file of the `ble_app_barebone_580.bin` is the `'ble_app_barebone.uvprojx'` under the folder `'\5.0.4\projects\target_apps\ble_examples\ble_app_barebone\Keil_5\'`.

DA14582 Firmware with Audio Test

This patch contains all the changes needed to re-create the following firmware:

- `prod_test_582.bin`

Note: This patch requires applying the [DA14580/1/2/3 Firmware](#) patch first.

In order to re-create the exact source code of the above firmware:

1. Use the modified SDK version as described in the above section.
2. Copy the contents of the `'..\fw_files\DUT\DA14582\DA1458x_SDK_5.0.4\DA1458x_SDK\5.0.4\'` folder to the current SDK.
3. The Keil v5 project file of the `prod_test_582.bin` is the `'prod_test.uvprojx'` under the folder `'\5.0.4\projects\target_apps\prod_test\prod_test\Keil_5\'`. In 'Select Target' option, select the `'prod_test_580'`, `'clean'` and `'build'` the project.

DA14585/6 Firmware

This patch contains all the changes needed to re-creates the following firmware:

- `prod_test_585.bin`
- `flash_programmer_585.bin`
- `prox_reporter_585.bin`

In order to re-create the exact source code of the above firmware:

1. Use a clean copy of the `DA14585_SDK_6.0.6.427` from the customer portal.
2. Copy the contents of the `'..\fw_files\DUT\DA14585_586\DA14585_SDK_6.0.6.427\DA14585_SDK\6.0.6.427\'` folder to the default SDK.
3. The Keil v5 project file of the `prod_test_585.bin` is the `'prod_test.uvprojx'` under the folder `'\6.0.6.427\projects\target_apps\prod_test\prod_test\Keil_5\'`.
4. The Keil v5 project file of the `flash_programmer_585.bin` is the `'programmer.uvprojx'` under the folder `'\6.0.6.427\utilities\flash_programmer\'`. Make sure that `'programmer_uart'` option is selected under 'Select Target'.
5. The Keil v5 project file of the `prox_reporter_585.bin` is the `'prox_reporter.uvprojx'` under the folder `'\6.0.6.427\projects\target_apps\ble_examples\prox_reporter\Keil_5\'`.

DA14585 Firmware for DA14585 IoT+ DK

This patch contains all the changes needed to re-create the following firmware:

DA1458x/DA1468x Production Line Tool

- prod_test_585_IoT+.bin

Note: This patch requires applying the [DA14585/6 Firmware](#) patch first.

In order to re-create the exact source code of the above firmware:

1. Use the modified SDK version as described in the above section.
2. The Keil v5 project file of the prod_test_585_IoT+.bin is the 'prod_test.uvprojx' under the folder '\5.0.4\projects\target_apps\prod_test\prod_test\Keil_5'. In 'Select Target' option, select the 'prod_test_585'.
3. Open project.
4. Open da1458x_config_advanced.h file and change the CFG_IOT_DK definition to
#define CFG_IOT_DK (1).
5. 'clean' and 'build' the project.

DA14681/2/3 Firmware

This patch contains all the changes needed to re-creates the following firmware:

- prod_test_681_01.bin
- prod_test_683_00.bin
- uartboot_681_01.bin
- pxp_reporter_681_01.bin.cached
- pxp_reporter_683_00.bin.cached

In order to re-create the exact source code of the above firmware:

1. Use a clean copy of the DA1468x_DA15xxx_SDK_1.0.12.1078 from the customer portal.
2. Copy the contents of the '...\fw_files\DUT\DA1468x-DA15xxx\DA1468x_DA15xxx_SDK_1.0.12.1078' folder to the default SDK.
3. The Smart Snippets Studio project file of the prod_test_681_01.bin and prod_test_683_00.bin is the 'plt_fw' under the folder '...\DA1468x_DA15xxx_SDK_1.0.12.1078\projects\dk_apps\reference_designs\plt_fw'. To create each binary, select from the drop down menu the "Release RAM" option for each chip.
4. The Smart Snippets Studio project file of the uartboot_681_01.bin is the 'uartboot' under the folder '...\DA1468x_DA15xxx_SDK_1.0.12.1078\sdk\bsp\system\loaders\uartboot\'. To create the binary, select from the drop down menu the "Release" option.
5. The Smart Snippets Studio project file of the pxp_reporter_681_01.bin.cached and pxp_reporter_683_00.bin.cached is the 'pxp_reporter' under the folder '...\DA1468x_DA15xxx_SDK_1.0.12.1078\projects\dk_apps\demos\pxp_reporter\'. To create each binary, select from the drop down menu the 'QSPI_Release' option for each chip.

Each binary will be created under the project folder in a folder having the same name as the selected option.

Note: The pxp_reporter source code generates a .bin file. In order to write it to the QSPI Flash memory and boot from it, a .cached version of the binary must be created using the 'bin2image.exe'. See [Bin2Image](#) for more details.

DA14683 Firmware for 32MHz XTAL

This patch contains all the changes needed to re-create the following firmware:

- prod_test_683_00_XTAL32MHz.bin

DA1458x/DA1468x Production Line Tool

- `uartboot_68x_XTAL32MHz.bin`
- `pxp_reporter_683_XTAL32MHz.bin.cached`

Note: This patch requires applying the [DA14681/2/3 Firmware](#) patch first.

In order to re-create the exact source code of the above firmware:

1. Use the modified SDK version as described in the above section.
2. The Smart Snippets Studio project file of the `prod_test_683_00_XTAL32MHz.bin` is the 'plt_fw' under the folder `'..\DA1468x_DA15xxx_SDK_1.0.12.1078\projects\dk_apps\reference_designs\plt_fw'`.
Before creating the binary, open `custom_config_ram.h` file and change the `dg_configEXT_CRYSTAL_FREQ` option to

```
#define dg_configEXT_CRYSTAL_FREQ          EXT_CRYSTAL_IS_32M.
```

Select from the drop down menu the 'DA14683-00 Release RAM' option to build the binary.
3. The Smart Snippets Studio project file of the `uartboot_68x_XTAL32MHz.bin` is the 'uartboot' under the folder `'..\DA1468x_DA15xxx_SDK_1.0.12.1078\sdk\bsp\system\loaders\uartboot'`.
Before creating the binary, open `custom_config.h` file and change the `dg_configEXT_CRYSTAL_FREQ` option to

```
#define dg_configEXT_CRYSTAL_FREQ          EXT_CRYSTAL_IS_32M.
```

To create the binary, select from the drop down menu the 'Release' option.
4. The Smart Snippets Studio project file of the `pxp_reporter_683_XTAL32MHz.bin.cached` is the 'pxp_reporter' under the folder `'..\DA1468x_DA15xxx_SDK_1.0.12.1078\projects\dk_apps\demos\pxp_reporter'`. Before creating the binary, open `custom_config_qspi.h` file and change the `dg_configEXT_CRYSTAL_FREQ` option to

```
#define dg_configEXT_CRYSTAL_FREQ          EXT_CRYSTAL_IS_32M.
```

Select from the drop down menu the 'DA14683-00 Release QSPI' option to build the binary.

Each binary will be created under the project folder in a folder having the same name as the selected option.

Note: The `pxp_reporter` source code generates a `.bin` file. In order to write it to the QSPI Flash memory and boot from it, a `.cached` version of the binary must be created using the `'bin2image.exe'`. See [Bin2Image](#) for more details.

DA1458x/DA1468x Production Line Tool

7 Applications

7.1 Introduction

The PLT software includes four different applications (Table 5). The CFG PLT is used to setup the system according to the device hardware options and select the required tests and memory actions to be performed. The GU Upgrade is used to update the Golden Unit firmware. The GUI and the CLI PLT applications are used to perform the tests, monitor their progress in real-time and view the test results.

7.2 CFG PLT Application

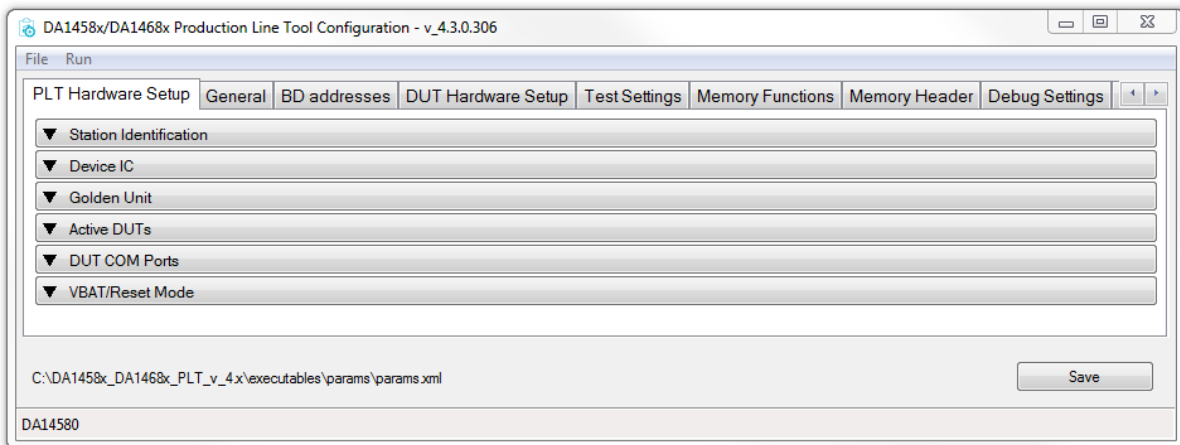

Note 1 Each Hardware Setup field can be minimized by clicking on it, but it will not be disabled. The tests will run if they are enabled, even when the test field is minimized and not shown.

Figure 32: CFG PLT Startup Screen

The CFG PLT application (DA1458x_DA1468x_CFG_PLT.exe) is a GUI application tool, which is mainly used to appropriately configure the tests and memory operations the tool will perform. Depending on the selected device chipset and the enabled actions, only appropriate options are enabled and shown. Any change made by the user is validated before being saved to the XML file, with the use of a schema XSD file. This prevents erroneous values to be stored in the XML file that would harm the production procedure.

Figure 32 shows the initial CFG PLT screen. The Main Menu options are described in Table 19 and the bottom strip information is described in Table 20. The application begins with the Hardware Setup tab (see section 7.2.2). Users can navigate to the other PLT configurable options by selecting the different tabs.

When a tab is selected, the settings of this tab are reloaded from the XML file. If there is an error in the configuration XML file, a warning message will be shown indicating which of the parameters has error. Additionally, the related graphic entry in the CFG application for the erroneous configuration parameter will be highlighted in red.

An example is given in Figure 33. Configuration parameter dut_num_1 has wrong value (error instead of either false or true) in the params.xml file. When the Hardware Setup CFG tab is selected the warning message will be displayed. If OK is pressed, the Hardware Setup tab will be loaded with the DUT 1 checkbox in red. The displayed value will be the default value taken from the XML schema document (params.xsd).

DA1458x/DA1468x Production Line Tool

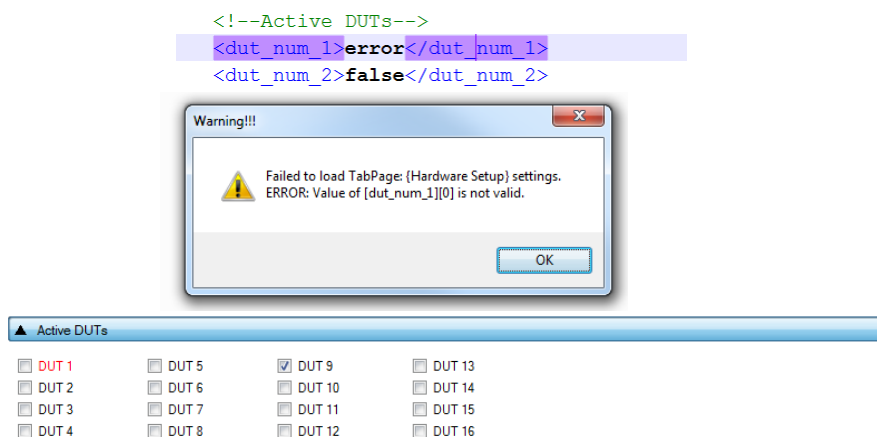

Figure 33: CFG PLT with Erroneous Configuration Parameter

When the user makes a change, the *Save* button will become *Save** to indicate that a save is required.

In case of a configuration parameter error, pressing *Save* will save the default parameter value, overwriting the erroneous value.

Table 19: CFG PLT Main Menu Options

Region	Option	Description
File	Open XML file	Opens a new XML file and loads the settings. The full path of the new XML file is shown at the bottom end of the screen.
	View XML file	Opens the XML file in notepad.
	Save as...	Exports all settings to a new XML file. The full path of the new XML file is shown at the bottom end of the screen.
	Reset to defaults	Overwrites all parameters options in the XML file with their default values taken from the XSD file.
	Exit	Exits the CFG PLT application.
Run	Run GUI PLT	Opens the GUI PLT application.
	Run CLI PLT	Opens the CLI PLT application.

Table 20: CFG PLT Bottom Strip Options

Option	Description
C:\Release\params\params.xml	Shows the full path of the XML file that is currently used.
DA14580	Shows the selected device IC.
Save	Saves all the options of the currently selected tab. E.g. If General settings tab is selected, then only the settings for this tab will be saved. Note: A shortcut for this button is the <code>Ctrl+S</code> key combination.

DA1458x/DA1468x Production Line Tool

7.2.1 XML and XSD Files

The CFG PLT application is a front-end user interface for the `cfg_dll.dll` library (Figure 20). The `cfg_dll.dll` library, explained in detail in [1], is an XML parser, editor and parameter validator. It has an easy-to-use API for reading and manipulating the `params.xml` file. File `params.xsd` is the XML schema used for parameter validation.

In the CFG PLT application, all user selectable options are loaded and saved inside the XML file, by effectively using the `cfg_dll.dll` library API. The XSD schema file `params.xsd` is not edited in any way but only read by the `cfg_dll.dll` library API, whenever a parameter validation is needed.

The `params.xml` file is separated into three main parts as explained in Table 21.

Table 21: XML File Parts

Part Name	Example	Description
Common part	<pre><programming_enable>true</programming_enable> <tests_enable>true</tests_enable> <retest_failed>>false</retest_failed> <!-- --> <!-- BD Addresses --> <!-- --> <bd_addr_mode>0</bd_addr_mode> <bd_addr_file_path>params\\bd_address.ini</bd_addr_file_path> <start_bd_addr>00:00:00:00:00:01</start_bd_addr> <next_bd_addr>00:00:00:00:00:01</next_bd_addr> <end_bd_addr>00:00:00:00:00:01</end_bd_addr> <scanner_iface>COM21</scanner_iface> <scan_mode_auto>1</scan_mode_auto></pre>	<p>The main top part of the XML file contains parameters common to any DUT, like the BD address mode, the COM ports and which device is enabled or disabled. It also holds the debug parameters, the test statistics and the test station name used in the logs.</p>
DA1458x	<pre><!-- DA1458x --> <config_params_da1458x> <!-- --> <!-- UART --> <!-- --> <uart_boot_pins>4</uart_boot_pins> <uart_change_pins>>false</uart_change_pins> <uart_pin_tx>P0_4</uart_pin_tx> <uart_pin_rx>P0_5</uart_pin_rx> <uart_baud_rate>1000000</uart_baud_rate></pre>	<p>The second XML part, with the element name <code>config_params_da1458x</code>, holds parameters used for DA1458x devices. Under this part, the entire test and memory action settings are stored.</p>
DA1468x	<pre><!-- DA1468x --> <config_params_da1468x> <!-- --> <!-- UART --> <!-- --> <uart_boot_pins>4</uart_boot_pins> <uart_baud_rate>1000000</uart_baud_rate> <!-- --></pre>	<p>The third and final XML part, with the element name <code>config_params_da1468x</code>, holds parameters used for DA1468x devices. Under this part, the entire test and memory action settings are stored.</p>

The XSD schema file, `params.xsd`, holds information about the overall structure of the `params.xml` file, the default and valid values a parameter can take and useful help information about the purpose of each parameter. An example part of the XSD file is given in Figure 34.

DA1458x/DA1468x Production Line Tool

```

<xs:element name="next_bd_addr"
  type="x:cfg_hex_array_6_bytes"
  x:use="required"
  x:default="00:00:00:00:00:01"
  x:info="The BD address of the first active DUT that will be used in the next test run." />
<!--cfg_hex_array_6_bytes-->
<xs:simpleType name="cfg_hex_array_6_bytes">
  <xs:restriction base="xs:string">
    <xs:pattern value="([0-9A-Fa-f]|[0-9A-Fa-f][0-9A-Fa-f])(:([0-9A-Fa-f]|[0-9A-Fa-f][0-9A-Fa-f])){5}"/>
  </xs:restriction>
</xs:simpleType>

<xs:element name="RF_path_loss_DUT_1"
  type="x:cfg_dut_path_losses"
  x:use="required"
  x:default="0"
  x:info="Set the RF path losses in dB between the device and the GU or the BLE tester instrument." />
<!--cfg_dut_path_losses-->
<xs:simpleType name="cfg_dut_path_losses">
  <xs:restriction base="xs:float">
    <xs:minInclusive value="0"/>
    <xs:maxInclusive value="40"/>
  </xs:restriction>
</xs:simpleType>

```

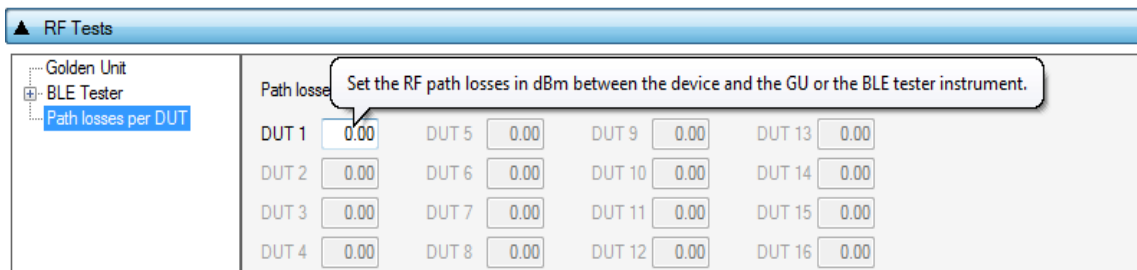

Figure 34: XSD Schema File Example

Element `next_bd_addr` holds the Next BD address, as described in section 7.2.4.1 and Table 31. It has a default value of `x:default="00:00:00:00:00:01"`. This default value will be returned by the `cfg_dll.dll` API if the XML file has an error entry in the equivalent `next_bd_addr` element, since the validation of the parameter will fail.

The `x:info="The BD address ..."` value will be loaded by the `cfg_dll.dll` API and be used in the CFG PLT tooltips. The `type="x:cfg_hex_array_6_bytes"` defines the parameter type. This is the actual XSD entry that is used for the parameter validation. The `cfg_hex_array_6_bytes` type is defined later in the file and has a rather complicated pattern defined with `<xs:pattern value="([0-9A-Fa-f]|...)" />`. If the `next_bd_addr` element in the XML file has a value that does not match this pattern, the validation of the parameter will fail and the `cfg_dll.dll` API will return the default value (00:00:00:00:01). In the CFG PLT, the default value will be shown in red, indicating that an error exists in the `params.xml` file for this parameter. It will not change the erroneous value in the `params.xml` file until the user presses the **Save** button, in which case the default value will overwrite the erroneous value.

In the second example of Figure 34, the `RF_path_loss_DUT_1` XSD element is shown. This element is used in the `Path Losses per DUT` as shown in Figure 62. This element has a default value of 0 and the allowed values are floats, between `<xs:minInclusive value="0"/>` and `<xs:maxInclusive value="40"/>`, as shown in the `cfg_dut_path_losses` type description. The `x:info="Set the RF path .." />` will be loaded by the `cfg_dll.dll` API and used in the CFG PLT tooltips as shown in the bottom part of Figure 34.

DA1458x/DA1468x Production Line Tool

7.2.2 Hardware Setup

This section describes the Hardware Setup settings available for the PLT hardware board, as shown in [Figure 32](#).

7.2.2.1 Station Identification

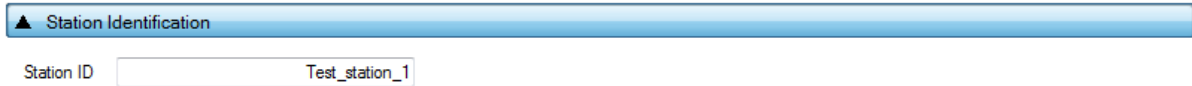

Figure 35: Station Identification

This field holds a name given by the user to distinguish between different test stations. The value of this field is written into the DUT log and CSV files. [Table 22](#) describes the available options for the *Station Identification*.

Table 22: Station Identification

Option	Description
Station ID	The name of the PLT test station.

7.2.2.2 Device IC

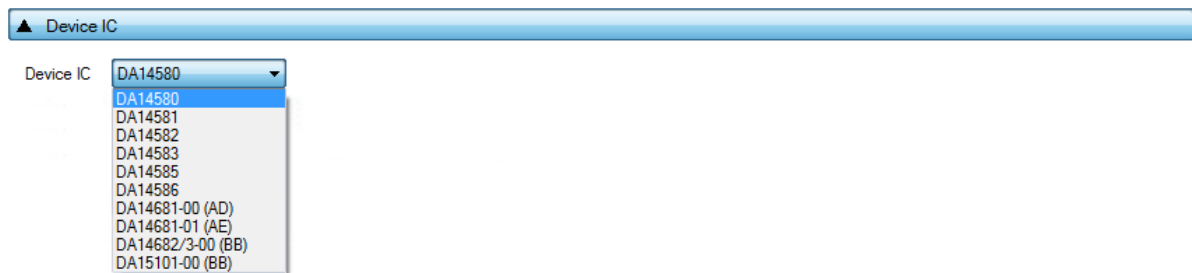

Figure 36: Device IC

Users can select the device IC type. This option will also change any IC related graphics, such as selectable tabs and tests. [Table 23](#) describes the available options for the *Device IC*.

Table 23: Device IC

Option	Description
Device IC	The Dialog BLE chipset used in the device under test.

7.2.2.3 Active DUTs

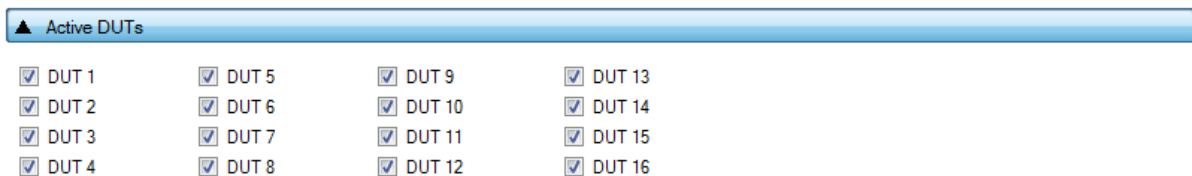

Figure 37: Active DUTs

Enables or disables the testing for each DUT. [Table 24](#) describes the available options for the *Active DUT*.

DA1458x/DA1468x Production Line Tool

Table 24: Active DUTs

Option	Description
DUT1-16	Enables the specific DUT device placed on connector DUT1-DUT16.

7.2.2.4 DUT COM Ports

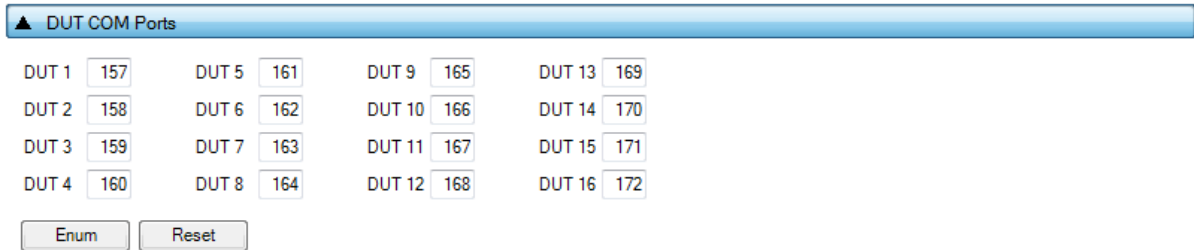

Figure 38: DUT COM Ports

This field shows the Windows COM port assigned to each DUT. The table is filled only when the 'COM Enum' action has been performed by the CFG or the GUI PLT applications, or when non-zero entries exist in the `com_port_x` params.xml options. When the 'COM Enum' action is performed, the tools will automatically find the DUT COM ports and save them in the `params.xml` file. These values will be read by the CFG PLT application and be displayed here. When a 'COM Enum' action has not been performed, the GUI PLT will automatically run it once in every first test execution.

Note: Great care must be taken when the `params.xml` file is shared across different stations, where different DUT COM Ports will probably exist. The 'COM Enum' action should then be performed again, so the new COM ports of the new PC system are identified and updated in the XML file.

Table 25 describes the available options for the *DUT COM Ports*.

Table 25: DUT COM Ports

Option	Description
DUT1-16	Shows the Windows COM port assigned to a specific DUT.
Reset	Sets all values to zero.
Enum	Executes the COM port enumeration procedure. The found COM ports are shown before being saved.

7.2.2.5 Golden Unit

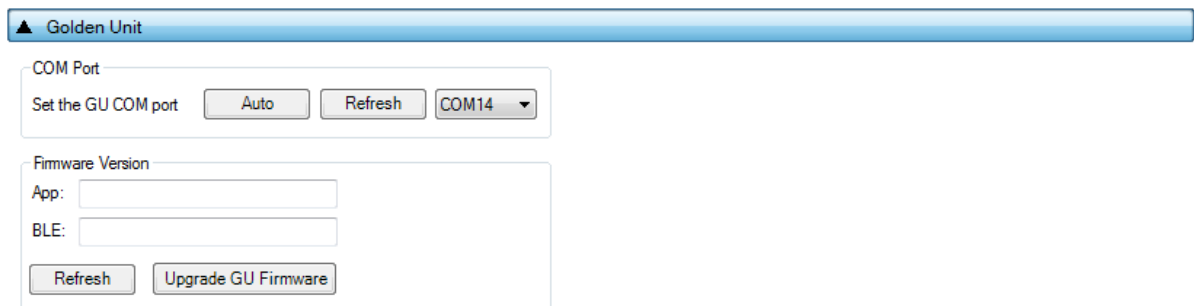

Figure 39: Golden Unit COM Port

This field holds the Golden Unit COM port. Manual or automatic COM port find can be selected.

The Golden Unit COM port can be manually selected from the list with all the available COM ports existing in the system. Additionally, it can automatically be found by pressing the `Auto` button. The

DA1458x/DA1468x Production Line Tool

automatic procedure searches the serial number of all system COM ports to find the “DialogSemi” string. Details on how to program the serial number in the GU FTDI can be found in [Appendix H](#).

Table 26: Set the GU COM Port

Option	Description
Auto	Initiates the automatic Golden Unit COM port find procedure.
Refresh	Refreshes the dropdown menu with all the available system COM ports.
Dropdown Menu	Manually select the Golden Unit COM port from all of the available system COM ports.

Table 27: Golden Unit Firmware Version Upgrade

Option	Description
Refresh	Retrieves the current BLE and application versions of the connected Golden Unit.
Upgrade GU Firmware	Opens the GU Upgrade , which is used to update the Golden Unit firmware.

7.2.2.6 VBAT/Reset Mode

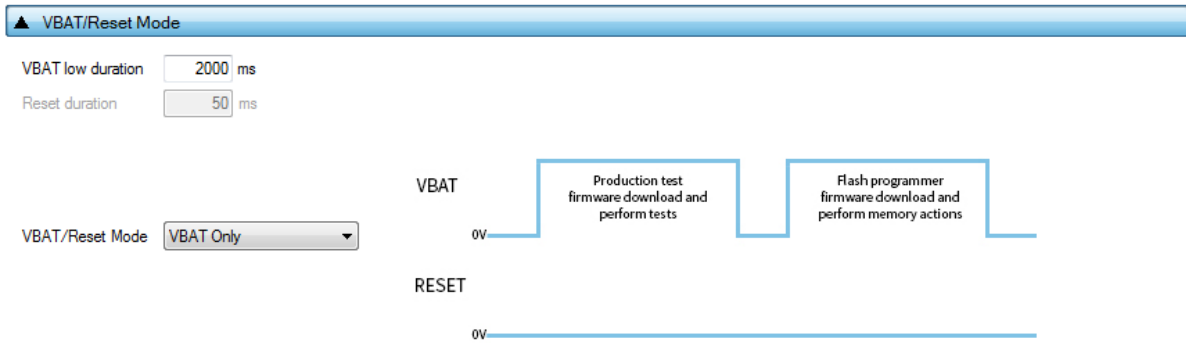

Figure 40: VBAT/Reset Mode Selection

This field holds the VBAT/Reset mode selections. This option sets the PLT VBAT and PLT Reset line modes for the DUT power supply and reset during the PLT test sequence. [Table 28](#) describes the available selections.

Table 28: VBAT/Reset Mode

Option	Description
VBAT/Reset Mode	Select the operation for VBAT/Reset signals. Available options are: <ul style="list-style-type: none"> • VBAT Only • VBAT On with Reset • VBAT as Reset • VBAT and Reset VBAT/Reset Signals Operation chapter describes each mode in detail. Default setting is <i>VBAT only</i> .

7.2.3 General

7.2.3.1 Statistics

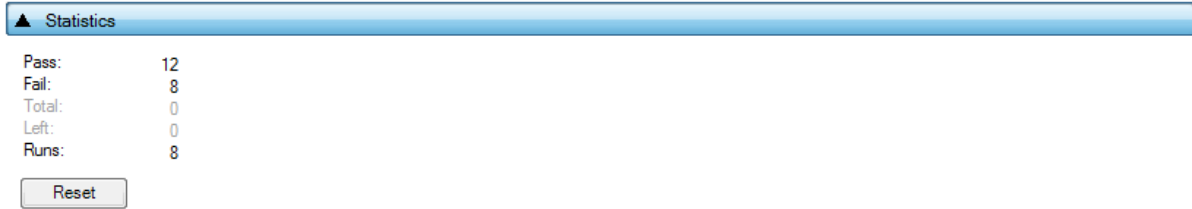

Figure 41: Statistics

This field holds the test result statistics. Table 29 describes the *Statistics* field.

Table 29: Statistics

Option	Description
Pass	Shows the number of DUTs that have successfully passed all the tests.
Fail	Shows the number of DUTs that have failed the tests.
Total	Shows the number of DUTs that will be tested. This option is available only when <i>Range</i> mode is enabled in the BD Address Assignment .
Left	Shows how many DUTs are still to be tested. This option is available only when <i>Range</i> mode is enabled in the BD Address Assignment .
Runs	Shows the number of test runs the PLT has performed.
Reset	Pressing the <i>Reset</i> button clears all statistics values to their defaults. Values <i>Pass</i> , <i>Fail</i> and <i>Runs</i> will be set to zero. If <i>Range</i> mode is enabled in the BD Address Assignment , the <i>Total</i> and <i>Left</i> values will be set as the difference of <i>Next</i> and <i>End BD address</i> , otherwise will be set to zero.

7.2.3.2 Test Options

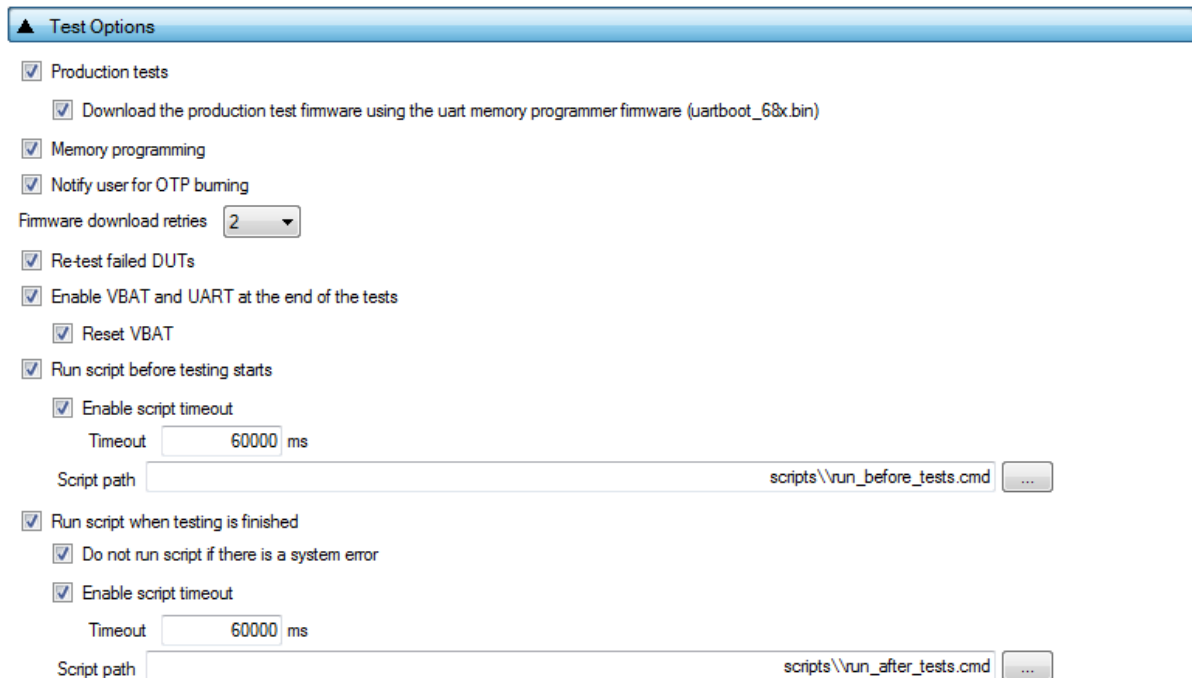

Figure 42: Test Options

DA1458x/DA1468x Production Line Tool

This field holds generic PLT test procedure options. The PLT procedure is split into two main parts: *Production tests* and *Memory programming*.

Production tests include all the tests under [Test Settings \(DA1458x\)](#) or [Test Settings \(DA1468x\)](#). Memory Programming includes all the tests under [Memory Functions \(DA1458x\)](#) or [Memory Functions \(DA1468x\)](#) and [Memory Header \(DA1458x\)](#) or [Memory Header \(DA1468x\)](#).

[Table 30](#) describes the available settings for the *Test Options*.

Table 30: Test Options

Option	Description
Production tests	This option enables the production test operations.
Download the production test firmware using the UART memory programmer firmware (uartboot_68x.bin). (Only for DA14681/2/3 Devices)	This option enables the downloading of the production test firmware using the memory programming firmware. PLT will first reset the DUTs and download the memory programming firmware (uartboot_68x.bin). It will then download the production test firmware to the DUTs and by using a special command it will replace the firmware. The DUTs will automatically reset to the production test firmware. This procedure saves production test time.
Memory programming	This option enables the memory programming operations.
Notify user for OTP burning	When this option is enabled, PLT will inform the user with all the OTP burning tests that are enabled. A pop-up message will appear prompting the user whether to proceed with the tests.
Firmware download retries	Configures the firmware download retries in case of an error during firmware download.
Re-test failed DUTs	When this option is enabled, any DUT that failed will immediately be retested with the exact same options, including the <i>BD address</i> . This option is the same to the <i>Retest failed DUTs - Enable</i> under GUI PLT Settings .
Enable VBAT and UART at the end of the tests	Enables the VBAT lines and UART communication between the PC and the devices after all the tests have finished. If enabled, DUTs will remain powered after the end of the tests.
Reset VBAT	If this option is enabled the VBAT line will be toggled. If not selected, the DUTs will keep in their system RAM the last test firmware downloaded by the PLT.
Run script before testing starts	This option enables the execution of a batch or an executable before the device testing procedure starts. As described in Running the GUI PLT and Executing Tests , the success return code should be a value between 0 and 100 for the tool not to report an error. Any other value will be taken as error and prevent the tool from running the tests.
Enable script timeout	Enables a wait timeout for the script to finish. The time to wait is set in the <code>timeout</code> field below. If this option is disabled PLT will wait until the script ends.
Timeout	The time to wait for the script to finish.
Script path	The path of file to execute when the <i>Run script before testing starts</i> option is enabled.
Run script when testing is finished	This option enables the execution of a batch or an executable after the device testing procedure has finished. The success return code should be 0 for the tool not to report an error.
Enable script timeout	Enables a wait timeout for the script to finish. The time to wait is set in the <code>timeout</code> field below. If this option is disabled, PLT will wait until the script ends.
Timeout	The time to wait for the script to finish.
Script path	The path of file to execute when the <i>Run script when testing is finished</i> option is enabled.

DA1458x/DA1468x Production Line Tool

7.2.4 BD Addresses

7.2.4.1 BD Address Assignment

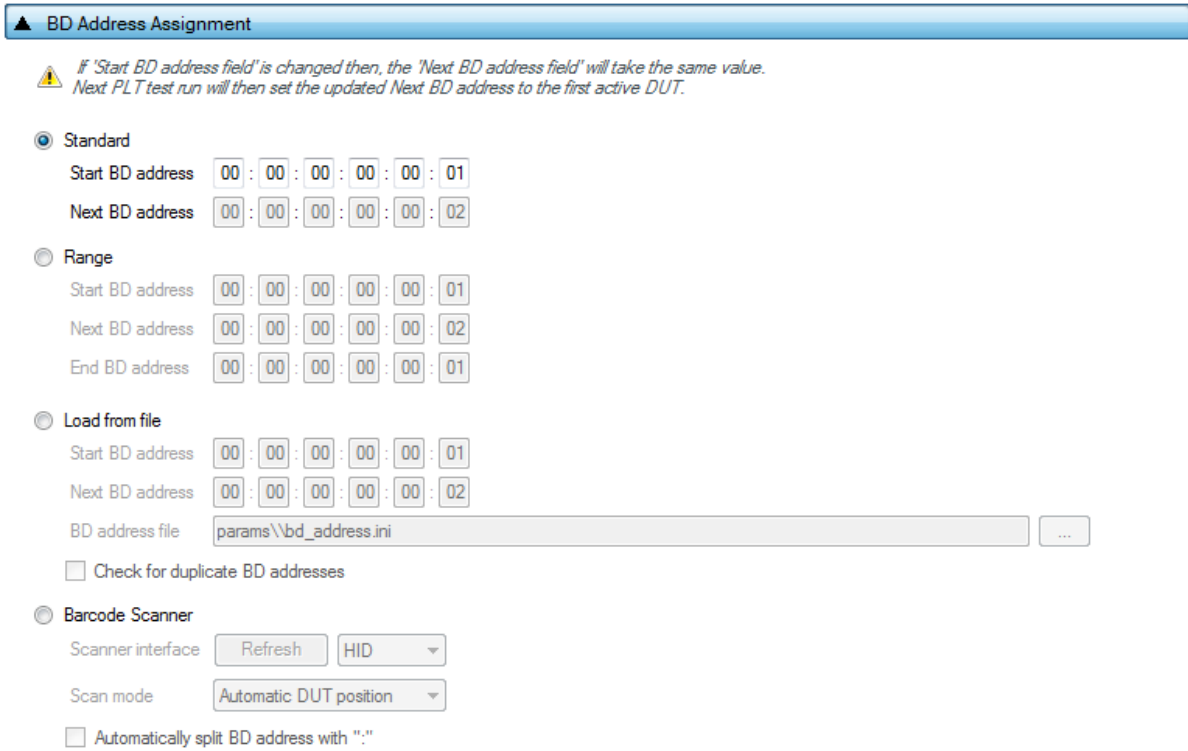

Figure 43: BD Address Assignment

The *BD Address Assignment* field defines different ways the PLT can handle the device BD address. The available modes are *Standard*, *Range*, *Load from file* and *Scan mode*.

The *Standard*, *Range*, and *Load from file* modes are similar. These have a *Start BD address*, which is the initial address that the PLT session begins. The *Next BD address* field holds the BD address that will be used on the next PLT run, so the BD address assignment can be continued even after the GUI PLT is closed. For that reason, the user cannot alter the *Next BD address*. The *Next BD address* initial value is the same as the *Start BD address* when the PLT session begins.

For *Scan mode*, an external barcode scanner is needed to assign the device BD addresses.

Note: In CFG PLT only the Start BD address is given. The assignment of the actual device BD addresses occurs in the GUI PLT at the beginning of each test run.

Note: The only invalid BD address is 00:00:00:00:00:00.

Standard Mode

Table 31 describes the available options for the *Standard* mode. In this mode, the first active DUT takes the *Next BD address*. This BD address is incremented by one and assigned to the next active DUT until all active DUTs have a BD address assigned to them.

This assignment mode never runs out of BD addresses and it will continue assigning addresses until the *Next BD address* reaches FF:FF:FF:FF:FF:FF.

DA1458x/DA1468x Production Line Tool

Table 31: BD Address Assignment - Standard Mode

Option	Description
Start BD address	The BD address that the PLT session has started with.
Next BD address	The BD address that will be used in the first active DUT of the next PLT run.

Range Mode

Table 32 describes the available options for the *Range* mode. This mode is the same as *Standard* mode except for the additional *End BD address*.

Since a 'Start BD address' and an 'End BD address' exist, the total amount of devices to be tested can be calculated. Therefore, this mode enables the *Total* and *Left* fields in the [Statistics](#), where *Total* is the number of the BD addresses to be used from *Start BD address* to *End BD address* and *Left* is the number of BD addresses remaining.

Note: The *End BD address* must always be greater than the *Start BD address*. In addition, when *Left* BD addresses are not enough for the remaining active DUTs, the PLT will not run.

Table 32: BD Address Assignment Options - Range Mode

Option	Description
Start BD address	The BD address that the PLT session has started with.
Next BD address	The BD address that will be used in the first active DUT of the next PLT run.
End BD address	The BD address that the PLT session will end with.

Load from File Mode

Table 33 describes the available options for the *Load from file* mode. In this mode, the *Start BD address* and the *Next BD address* have the same roles as before. The difference in this mode is that the BD addresses are loaded from a file in the order as they are written in that file, not using the automatic incremental method of the previous modes. In every test run, the PLT will search for the first occurrence of the *Next BD address* in the file and will load it along with the BD addresses that follow, until all active DUTs have a BD address.

```

1  00:00:00:44:33:0a
2  00:00:00:44:33:09
3  00:00:00:44:33:08
4  00:00:00:11:22:08
5  00:00:00:11:22:06
6  00:00:00:11:22:05
7  00:00:00:11:22:04
8  00:00:00:11:22:03
9  00:00:00:11:22:02

```

Figure 44: Example for Load from File Mode

For example, consider three active DUTs: DUT3, DUT6, and DUT 9 and the *Next BD address* to be 00:00:00:11:22:08. Figure 44 shows the beginning of the BD address file used in this example. The PLT will search for the *Next BD address* in the file and load it to the first active DUT: DUT3. It will then continue with 00:00:00:11:22:06 for DUT6 and 00:00:00:11:22:05 for DUT9. It will also return 00:00:00:11:22:04 as the *Next BD address* to be used in the next PLT test run.

Note: The BD address file should always end with a zero BD address (00:00:00:00:00:00) and a new line at the end.

DA1458x/DA1468x Production Line Tool

Table 33: BD Address Assignment Options - Load from File Mode

Option	Description
Start BD address	The BD address that the PLT session has started with.
Next BD address	The BD address from file that will be used in the first active DUT of the next PLT run.
BD address file	Path to the file that contains the BD addresses. Use button [...] on the right to navigate and select a file.
Check for duplicate BD addresses	Before any BD address is assignment happens, there will be a check to find double BD addresses in the selected BD address file.

Scan Mode

Table 34 describes the available options for the *Scan* mode. For this option a USB-to-Serial barcode scanner should be used to scan for BD address barcodes with 'xx:xx:xx:xx:xx:xx' format.

The barcode scanner options are the same as those used for the barcode scanner mode in [Custom Memory Data](#) for the DA1458x devices and in [Custom Memory Data](#) for the DA1468x devices.

Note: Barcode scanner mode is only available with [GUI PLT Application](#). [CLI PLT Application](#) does **NOT** support this feature.

Table 34: BD Address Assignment Options - Scan Mode

Option	Description
Scanner Interface	<p>Selection of the Barcode scanner input. Both HID and COM port interfaces are supported. This dropdown list provides an HID and all the available system COM ports as input options.</p> <p>For the HID interface, any HID device is supported that includes newline (CR-LF) characters at the end of the scanned data.</p> <p>For the COM port interface, a common USB to UART barcode scanner is supported. PLT has been tested with Honeywell Xenon 1900. Appendix L describes the setup procedure.</p> <p>This option is the exact same option as for the DA1458x devices in Custom Memory Data and the DA1468x devices in Custom Memory Data.</p>
Scan mode	<ul style="list-style-type: none"> Scan DUT position: In this mode the users must first scan the DUT position number and then the BD address. The string used for the position of each DUT is "TEST POSITION 0xx" where "xx" is the DUT position number. Automatic DUT position: Scanned BD address will be assigned to the selected DUT. The DUT selection is automatically been made, starting from the first active DUT and selecting the next one after a successful BD address scan. Users can change the selected DUT using the controls on the GUI PLT screen shown in Figure 117. <p>This option is the exact same option as for the DA1458x devices in Custom Memory Data and the DA1468x devices in Custom Memory Data.</p>
Automatically split BD address with ':'	<p>When this option is enabled, the input data will be automatically delimited with colon marks. E.g. To enter the '11:22:33:44:55:66' BD address the input string should be '112233445566'.</p>

DA1458x/DA1468x Production Line Tool

7.2.5 DUT Hardware Setup (DA1458x)

7.2.5.1 UART Boot Pins Setup

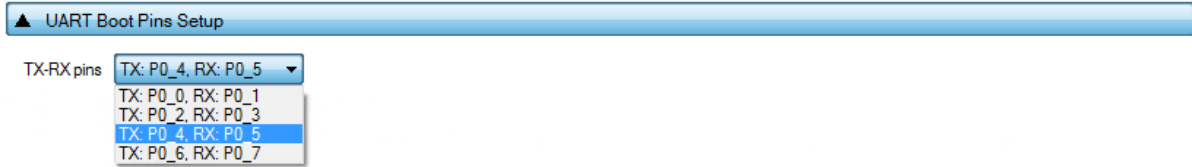

Figure 45: UART Boot Pins Setup - DA1458x

Table 35 describes the available options for the *TX-RX pins* of the *UART Boot Pins Setup* DA1458x options. The *TX-RX pins* selection defines the UART pins and the baud rate that will be used for firmware downloading to the DA1458x during boot.

Table 35: UART TX-RX Pins - DA1458x

Option	Description
TX: P0_0, RX: P0_1	Sets UART TX pin to P0_0, UART RX pin to P0_1 and Baud rate to 57600 bit/s.
TX: P0_2, RX: P0_3	Sets UART TX pin to P0_2, UART RX pin to P0_3 and Baud rate to 115200 bit/s.
TX: P0_4, RX: P0_5	Sets UART TX pin to P0_4, UART RX pin to P0_5 and Baud rate to 57600 bit/s.
TX: P0_6, RX: P0_7	Sets UART TX pin to P0_6, UART RX pin to P0_7 and Baud rate to 9600 bit/s.

Note: The baud rate is fixed during booting, since it is controlled by the device ROM bootloader.

7.2.5.2 UART Baud Rate

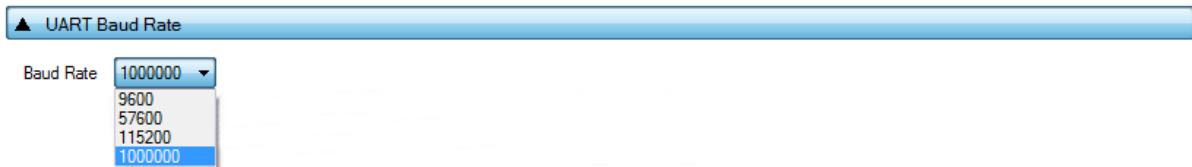

Figure 46: UART Baud Rate - DA1458x

Table 36 shows the available options for the *UART baud rate*.

The *Baud Rate* selected here is used after the initial firmware (*flash_programmer_580/5.bin*) has been downloaded to the DUT. The software will send a command to the DUT to change the UART baud rate to the one selected. All following UART communications with the DUT will be performed using the new baud rate. Please note that this happening only during memory programming where the *flash_programmer_580/5.bin* is used. During tests (RF tests, XTAL trimming, etc.), where the production test firmware is used, the baud rate is fixed at 115200 bit/s.

Table 36: UART Baud Rate - DA1458x

Option	Description
Baud Rate	<ul style="list-style-type: none"> 9600 [bit/s] 57600 [bit/s] 115200 [bit/s] 1000000 [bit/s] <p>Note: 1 Mbit/s is the fastest and safest with 0% baud rate error.</p>

DA1458x/DA1468x Production Line Tool

7.2.5.3 UART Programming GPIOs Setup

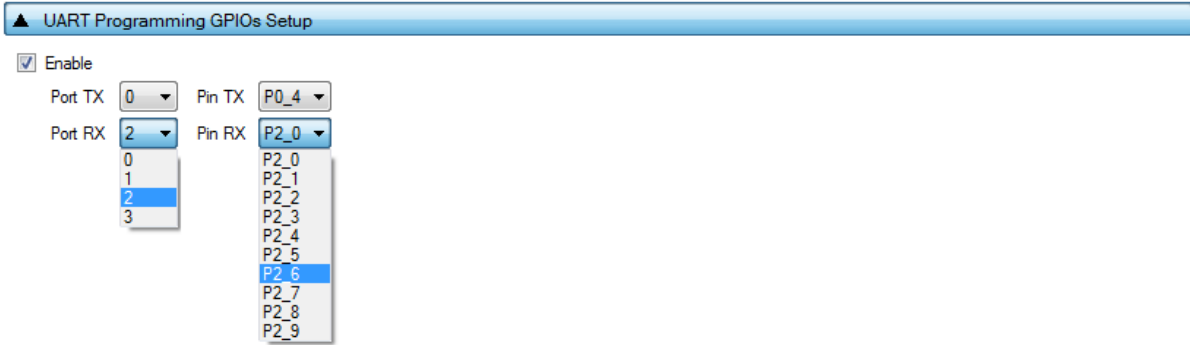

Figure 47: UART Programming GPIOs Setup - DA1458x

Table 37 shows the available options for the *UART Programming GPIOs* to be used during memory programming for the DA1458x devices.

Note: This option should be **disabled** if the *UART Programming GPIOs* are exactly the same as the *UART Boot Pins* selected in [UART Boot Pins Setup](#).

When this option is enabled, the user can configure a new set of UART pins to be used during tests and memory programming. The purpose of changing pins is to be able to use different UART pins than the predefined pairs supported by the DUT ROM bootloader, in case these default pins are used for other external components.

The DUT will always boot from a predefined pair of pins as configured in the *UART Boot Pins Setup*. Then it will switch to the new pins configured here by sending a command to the firmware, for both the *Production tests* and the *Memory programming* firmware. A separate UART hardware connection has to be made between the PLT hardware board and the DUT.

The DUT will have four UART connections with the PLT hardware. The connections should be made using enhanced PLT DUT connectors. For a single DUT, the UART boot pins should be connected to the PLT DUT connector 1 (DUT1) and the UART Programming GPIOs should be connected to the PLT DUT connector 2 (DUT2). In this configuration, the PLT can support up to eight DUTs.

Table 37: UART Programming GPIOs Setup - DA1458x

Option	Description
Enable	This option enables the UART programming mode. Users can select the new UART TX-RX GPIOs from the dropdown lists.
Port TX	Dropdown list to select the port of the UART TX GPIO that will be used during testing. This option alters the contents of the <i>Pin TX</i> dropdown list to the available GPIOs based on the selected port.
Pin TX	Dropdown list to select the UART TX GPIO that will be used during testing.
Port RX	Dropdown list to select the port of the UART RX GPIO that will be used during testing. This option alters the contents of the <i>Pin RX</i> dropdown list to the available GPIOs based on the selected port.
Pin RX	Dropdown list to select the UART RX GPIO that will be used during testing.

7.2.5.4 Sleep Clock Source

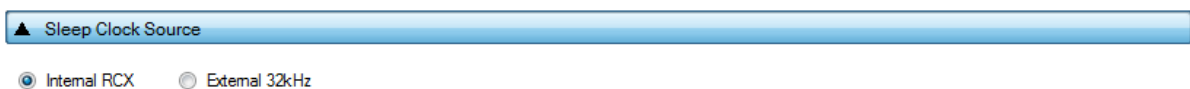

Figure 48: Sleep Clock Source - DA1458x

DA1458x/DA1468x Production Line Tool

Table 38 describes the available options for the DA1458x Sleep Clock Source operation.

Table 38: Sleep Clock Source - DA1458x

Option	Description
Internal RCX/External 32kHz	Select which crystal the DUTs will use during sleep.

7.2.5.5 SPI Flash Configuration

Figure 49: SPI Flash Configuration - DA1458x

Table 39 describes the available options for the SPI Pin Setup.

Table 39: SPI Pin Setup - DA1458x

Option	Description
SPI pin setup	This option enables the SPI pin selections. If this option is disabled, default pin configuration will be used. For the DA14583 and DA14586 this option will be disabled and their default pin configuration as described in Appendix J and Appendix K will be used.
CLK	Sets the GPIO for the CLK pin of the SPI bus. Default GPIO pin is P0_0.
MISO	Sets the GPIO for the MISO pin of the SPI bus. Default GPIO pin is P0_5.
MOSI	Sets the GPIO for the MOSI pin of the SPI bus. Default GPIO pin is P0_6.
CS	Sets the GPIO for the CS pin of the SPI bus. Default GPIO pin is P0_3.
Enable pin	Sets a specific GPIO to high state during any SPI flash operation.
Pin	Sets the GPIO to be used as the enable pin.

Table 40 describes the available options for the DA1458x SPI Flash Configuration. In order to properly setup the SPI Flash configuration, refer to the datasheet of the memory to be used.

DA1458x/DA1468x Production Line Tool

Note: If the memory to be used is listed in the supported memories ([Appendix T](#)), then the on demand SPI flash configuration option is not needed.

Table 40: SPI Flash Configuration - SPI Flash Options - DA1458x

Option	Description
SPI flash options	Enables the on demand SPI flash configuration.
Word length	Shows the length of each word in the SPI-bus.
Mode type	Shows the SPI-bus role of the chip.
SPI clock idle polarity	Sets the level of the idle state of the clock.
SPI sampling edge	Sets the SPI-bus sampling edge.
SPI interrupt	Enables the SPI interrupt. Note: This interrupt may be shared with other interrupts.
SPI clock divider	Sets the SPI-bus clock frequency.
Total size	Sets the SPI Flash size in bytes.
Page size	Sets the size of each page of the SPI Flash memory.
Jedec ID	Sets the SPI Flash Jedec ID.
Jedec ID mask	Sets the bitmask of the Jedec ID.
Memory protection	Sets the SPI Flash protection value.

7.2.5.6 I2C EEPROM Configuration

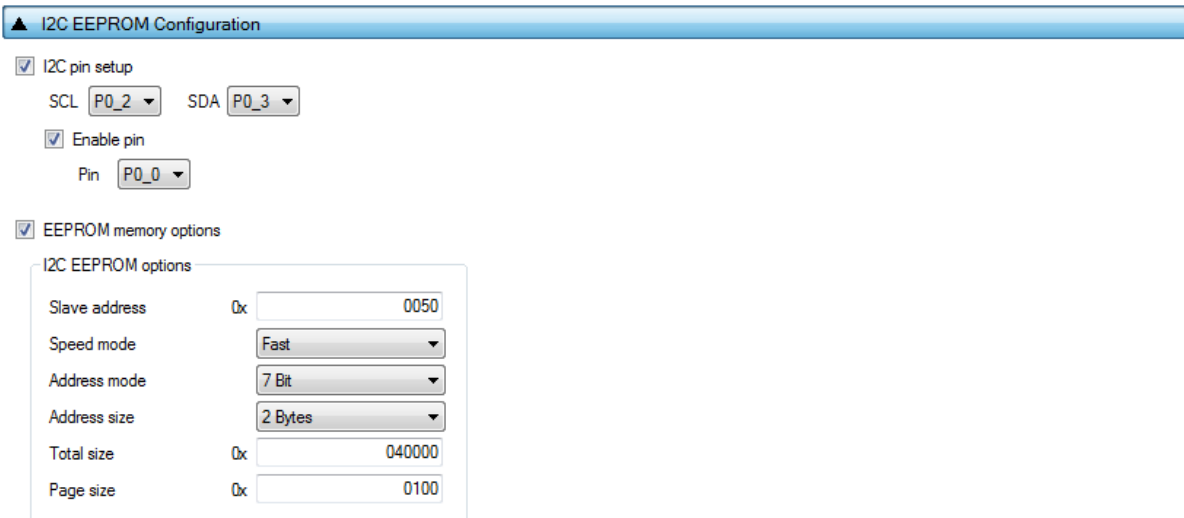

Figure 50: I2C EEPROM Configuration - DA1458x

DA1458x/DA1468x Production Line Tool

Table 41 describes the available options for the I2C Pin Setup.

Table 41: I2C Pin Setup - DA1458x

Option	Description
I2C pin setup	This option enables the I2C pin selections. If this option is disabled, the default pin configuration will be used.
SCL	Sets the GPIO for the SCL pin of the I2C bus. Default GPIO pin is P0_2.
SDA	Sets the GPIO for the SDA pin of the I2C bus. Default GPIO pin is P0_3.
Enable pin	Sets a specific GPIO to high state during any EEPROM operation.
Pin	Sets the GPIO to be used as the enable pin.

Table 42 describes the available options for the DA1458x I2C EEPROM Configuration. In order to properly setup the I2C EEPROM configuration, refer to the datasheet of the memory to be used.

Note: If the memory to be used is listed in the supported memories (Appendix T), then the on demand I2C EEPROM configuration option is not needed.

Table 42: I2C EEPROM Configuration – EEPROM Memory Options - DA1458x

Option	Description
EEPROM memory options	Enables the on demand EEPROM memory configuration.
Slave address	Sets the I2C-bus slave address of the EEPROM memory to be used.
Speed mode	Sets the I2C-bus speed.
Address mode	Sets the I2C-bus addressing mode.
Address size	Sets the I2C-bus number of bytes used for address.
Total size	Sets the EEPROM size in bytes.
Page size	Sets the size of each page of the EEPROM memory.

7.2.5.7 Range Extender Configuration



Figure 51: Range Extender Configuration - DA1458x

Table 43 describes the available options for the DA1458x Range Extender Configuration operation.

Table 43: Range Extender Configuration - DA1458x - DA1458x

Option	Description
Enable	Enables the Range extender.
Power control GPIO	Sets the GPIO to be used for the power control of the range extender.
Max power GPIO	Sets the GPIO to be used to indicate the maximum power of the range extender.

DA1458x/DA1468x Production Line Tool

7.2.6 Test Settings (DA1458x)

7.2.6.1 XTAL Trim

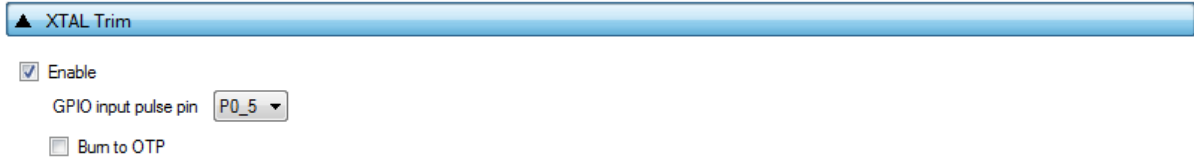

Figure 52: XTAL Trim - DA1458x

Table 44 describes the available options for the DA1458x XTAL Trim operation.

Table 44: XTAL Trim - DA1458x

Option	Description
Enable	This option enables the automatic crystal oscillator frequency calibration procedure.
GPIO input pulse pin	The GPIO on which the DUT will receive the reference pulse during calibration. The UART RX pin can be used for this purpose without any additional connection from the PLT hardware to the DUT.
Burn to OTP	When this option is selected, the XTAL trim value calculated from the automated calibration process will be written into the OTP XTAL trim header field and the OTP XTAL calibration flag will be set.

7.2.6.2 GPIO Watchdog operation

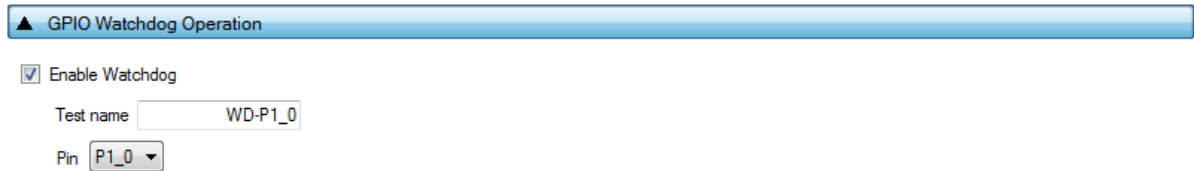

Figure 53: GPIO Watchdog operation - DA1458x

Table 45 describes the available options for the DA1458x GPIO Watchdog operation.

Table 45: GPIO Watchdog operation - DA1458x

Option	Description
Enable Watchdog	This option enables the continuous toggling of a GPIO during the whole production testing and memory programming procedure, except during firmware download. The pulse on the GPIO has approximately 1.5% duty cycle and 0.48Hz frequency.
Test name	The name assigned for this test.
Pin	Select the GPIO that will be toggled.

DA1458x/DA1468x Production Line Tool

7.2.6.3 Scan DUT Advertise Test

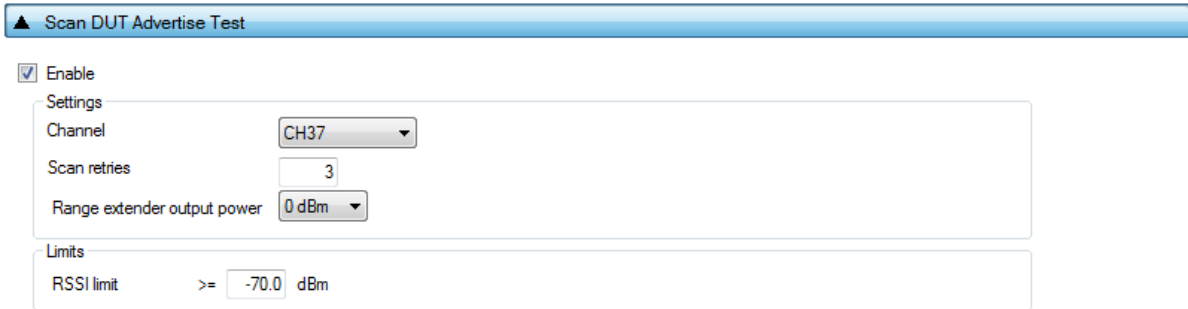

Figure 54: Scan DUT Advertise Test - DA1458x



Table 46 describes the available options for the DA1458x *Scan DUT Advertise Test* operation. In this test, the Golden Unit acts as a scanner and the DUTs start advertising using HCI commands.

Table 46: Scan DUT Advertise Test - DA1458x

Option	Description
Enable	This option enables the <i>Scan DUT Advertise Test</i> operation.
Channel	The BLE channel frequency used in the RF RX test using the Golden Unit.
Scan retries	The number of retries to perform the test.
Range extender output power (only in DA14585 with the range extender enabled)	Set the range extender power mode for this test.
RSSI limit	The RSSI limit for pass/fail criteria in the RF RX test using the Golden Unit. If the average RSSI of the device after it has received the packets transmitted from the Golden Unit is less than that the test will be considered as failed.

7.2.6.4 RF Tests

This section refers to various RF tests conducted between the DUTs and the Golden Unit or an external BLE tester.

These tests can have multiple instances with different settings. Tests can be added and removed using the two buttons (e.g.  and  in Figure 55) at the bottom right side of each panel.

Note: When adding or removing a test, all settings are refreshed with the values written to the XML file, meaning that any unsaved settings will be lost.

DA1458x/DA1468x Production Line Tool

Golden Unit

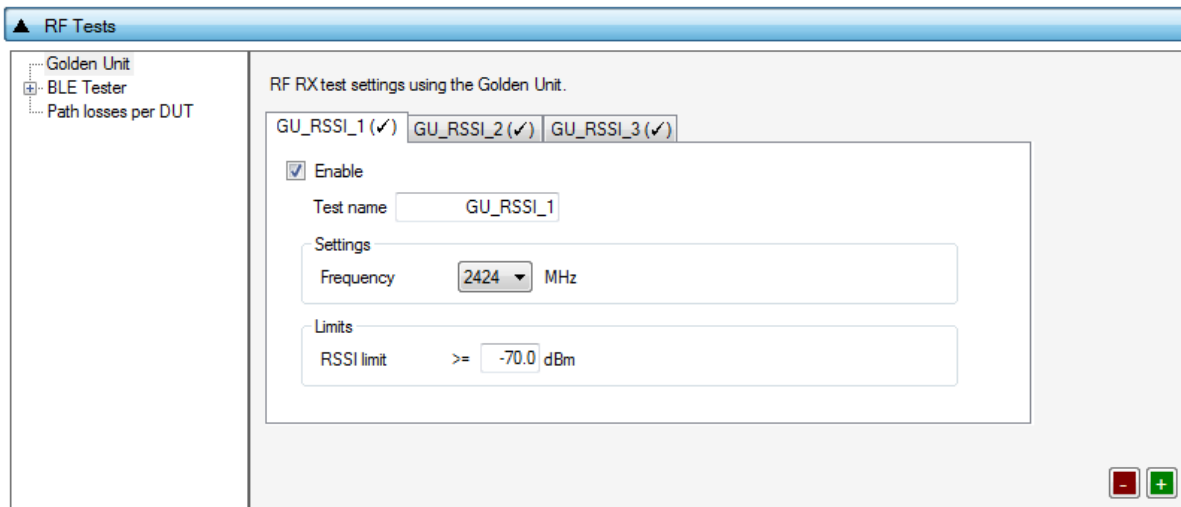

Figure 55: Golden Unit RF Tests - DA1458x

Table 47 describes the available options for the *RF RX* test using the *Golden Unit* as a transmitter.

In the *RF RX* test, the *Golden Unit* sends 500 packets on the selected BLE channel. The *DUTs* are set in receive mode and the *RSSI* is measured. If the *RSSI* measured by the *DUT* reception is less than the specified *RSSI limit* value, the device will fail and the tests will stop for that particular device.

Table 47: Golden Unit RF Tests - DA1458x

Option	Description
Enable	This option enables the specific <i>RF RX</i> test using the <i>Golden Unit</i> as a transmitter.
Test name	The name assigned to each test. The assigned name will be shown on the tab and next to it an indication showing whether the specific test is enabled or not.
Frequency	The BLE channel frequency used in the <i>RF RX</i> test using the <i>Golden Unit</i> .
RSSI limit	The <i>RSSI</i> limit for pass/fail criteria in the <i>RF RX</i> test using the <i>Golden Unit</i> . If the average <i>RSSI</i> of the device, after it has received the packets transmitted from the <i>Golden Unit</i> , is less than the value entered here the test will fail.

DA1458x/DA1468x Production Line Tool

BLE Tester

In the *BLE Tester* panel, a number of tests can be enabled that require an external BLE tester instrument.

BLE Tester – General Settings

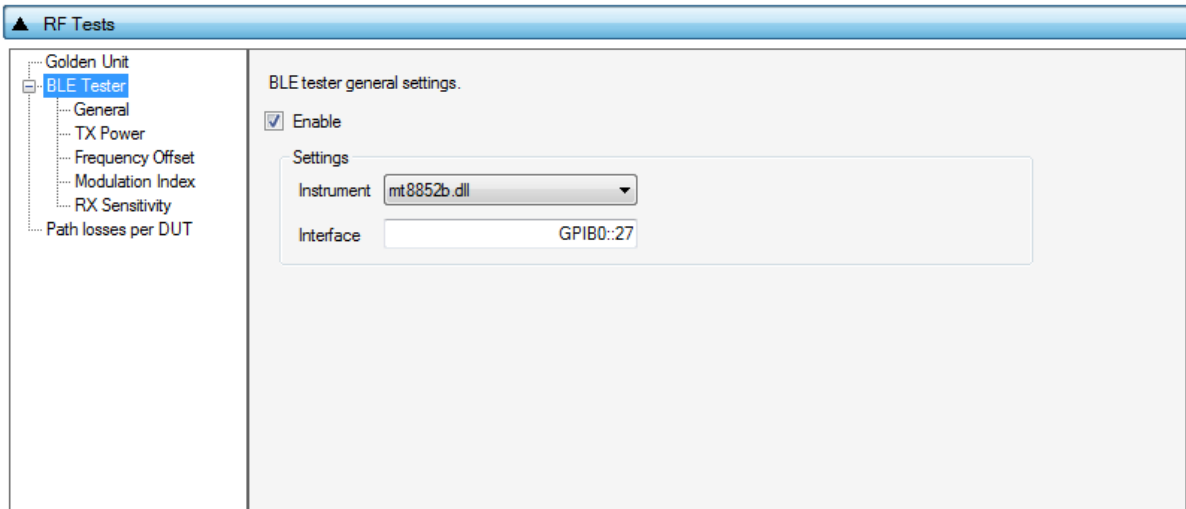

Figure 56: BLE Tester General Settings - DA1458x

Table 48 describes the general settings for the *BLE Tester* supported tests. Any available external instrument found by the `ble_tester_driver` DLL and their interfaces can be selected.

Table 48: BLE Tester General Settings - DA1458x

Option	Description
Enable	This option enables all of the <i>BLE Tester</i> tests, which include: <ul style="list-style-type: none"> • BLE Tester TX Power • Frequency Offset • Modulation Index • RX Sensitivity
Instrument	Select the BLE tester DLL name. Names are shown only if a BLE tester instrument DLL exists in the project <code>ble_tester_instr_plugins</code> folder.
Interface	The interface of the instrument to be used by the driver.

BLE Tester - TX Power

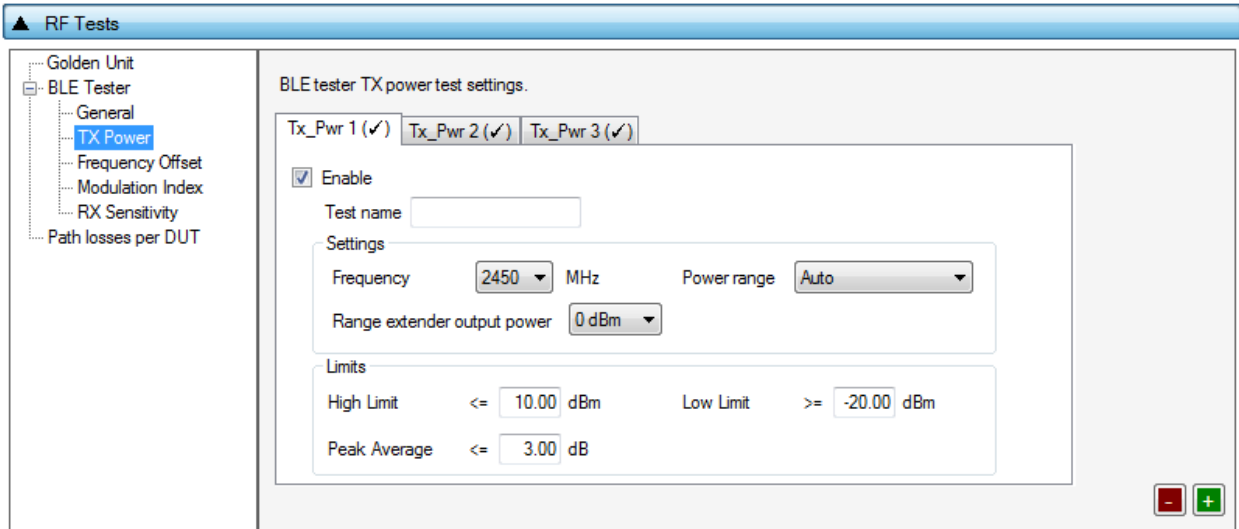

Figure 57: BLE Tester TX Power - DA1458x

Table 49 describes the available options for the TX Power test using a BLE Tester instrument.

Table 49: BLE Tester TX Power - DA1458x

Option	Description
Enable	This option enables the specific TX power test using a BLE tester instrument.
Test name	The name assigned to each test. The assigned name will be shown on the tab and next to it an indication showing whether the specific test is enabled or not.
Frequency	The BLE channel frequency used in the BLE TX power test.
Power range	Set the device TX output power range. Available options are: <ul style="list-style-type: none"> • Auto (No auto option for Litepoint IQxel-M. Sets the instrument to trigger at -25dBm) • +22 dBm to +7 dBm • +9 dBm to -3 dBm • +5 dBm to -7 dBm • -4 dBm to -16 dBm • -12 dBm to -26 dBm • -24 dBm to -35 dBm Default value is <i>Auto</i> .
Range extender output power (only in DA14585 with the range extender enabled)	Set the range extender power mode for this test.
High limit	Set the average high power limit for the BLE TX output power pass/fail test criteria.
Low limit	Set the average low power limit for the BLE TX output power pass/fail test criteria.
Peak average	Set the peak-to-average power limit for the BLE TX output power pass/fail test criteria.

BLE Tester - Frequency Offset

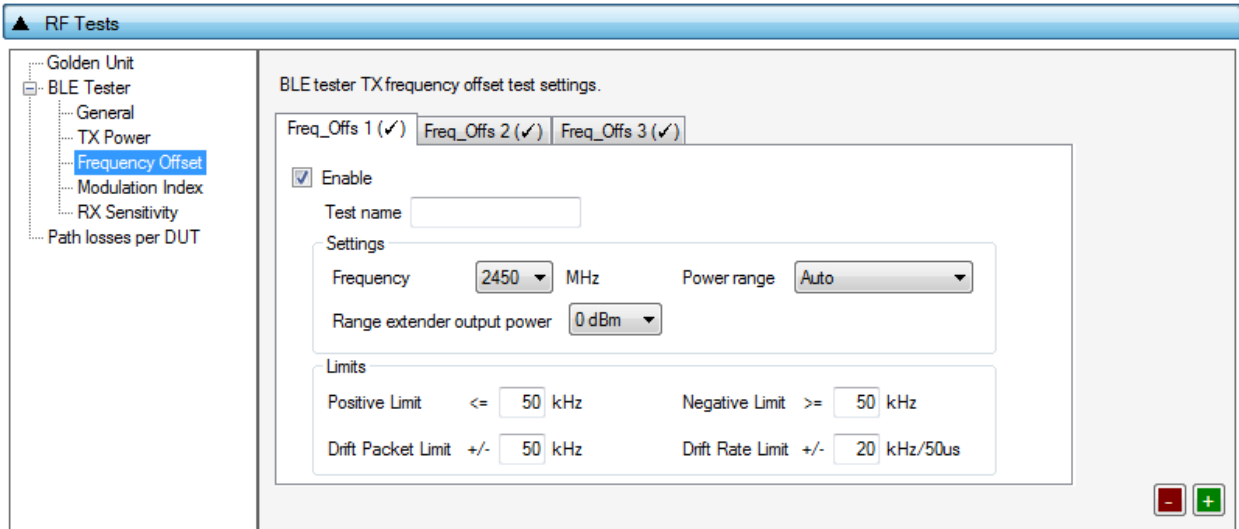

Figure 58: BLE Tester Frequency Offset - DA1458x

Table 50 describes the available options for the *Frequency Offset* test using a BLE Tester instrument.

Table 50: BLE Tester Frequency Offset - DA1458x

Option	Description
Enable	This option enables the specific TX frequency offset test using a BLE tester instrument.
Test name	The name assigned to each test. The assigned name will be shown on the tab and next to it an indication showing whether the specific test is enabled or not.
Frequency	The BLE channel frequency used in the BLE TX frequency offset test.
Power range	Set the device TX output power range. Available options are: <ul style="list-style-type: none"> • Auto • +22 dBm to +7 dBm • +9 dBm to -3 dBm • +5 dBm to -7 dBm • -4 dBm to -16 dBm • -12 dBm to -26 dBm • -24 dBm to -35 dBm Default value is <i>Auto</i> .
Range extender output power (only in DA14585 with the range extender enabled)	Set the range extender power mode for this test.
Positive limit	Set the maximum positive offset limit in kHz for the TX carrier frequency offset pass/fail test criteria.
Negative limit	Set the maximum negative offset limit in kHz for the TX carrier frequency offset pass/fail test criteria.
Drift packet limit	Set the overall packet drift in kHz for the TX drift pass/fail test criteria.
Drift rate limit	Set the drift rate limit in kHz/50 μs for the TX drift pass/fail test criteria.

BLE Tester - Modulation Index

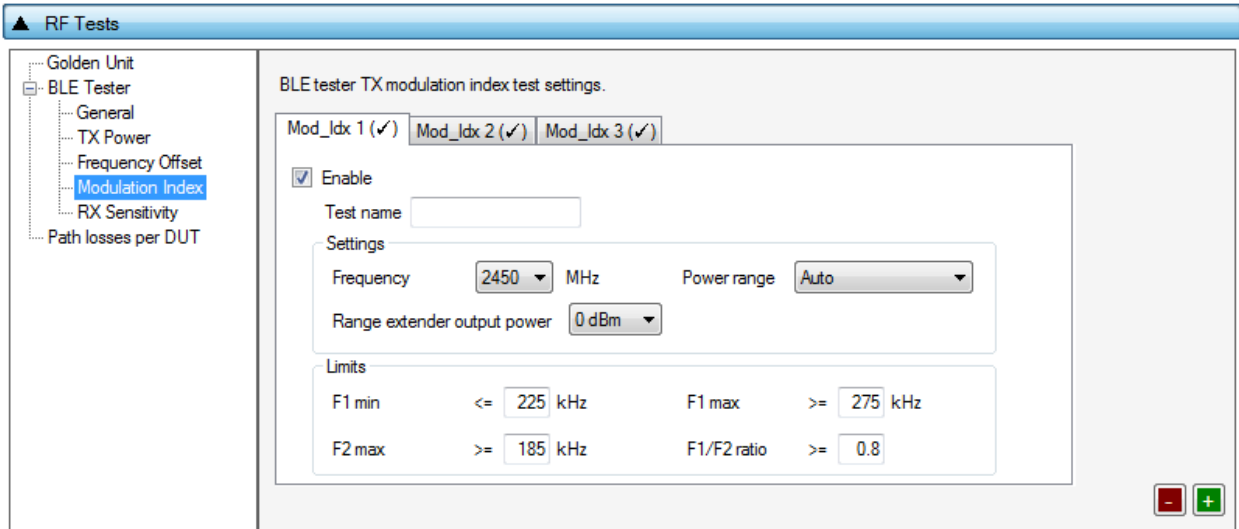

Figure 59: BLE Tester Modulation Index - DA1458x

Table 51 describes the available options for the *Modulation Index* test using a BLE Tester instrument.

Table 51: BLE Tester Modulation Index - DA1458x

Option	Description
Enable	This option enables the specific TX modulation index test using a BLE tester instrument.
Test name	The name assigned to each test. The assigned name will be shown on the tab and next to it an indication showing whether the specific test is enabled or not.
Frequency	The BLE channel frequency used in the BLE TX modulation index offset test.
Power range	Set the device TX output power range. Available options are: <ul style="list-style-type: none"> • Auto • +22 dBm to +7 dBm • +9 dBm to -3 dBm • +5 dBm to -7 dBm • -4 dBm to -16 dBm • -12 dBm to -26 dBm • -24 dBm to -35 dBm Default value is <i>Auto</i> .
Range extender output power (only in DA14585 with the range extender enabled)	Set the range extender power mode for this test.
F1 min	Set the F1 minimum average limit in kHz for the TX modulation index pass/fail test criteria.
F1 max	Set the F1 maximum average limit in kHz for the TX modulation index pass/fail test criteria.
F2 max	Set the F2 maximum limit in kHz for the TX modulation index pass/fail test criteria.
F1/F2 ratio	Set the F1/F2 maximum average ratio limit for the TX modulation index pass/fail test criteria.

BLE Tester - RX Sensitivity

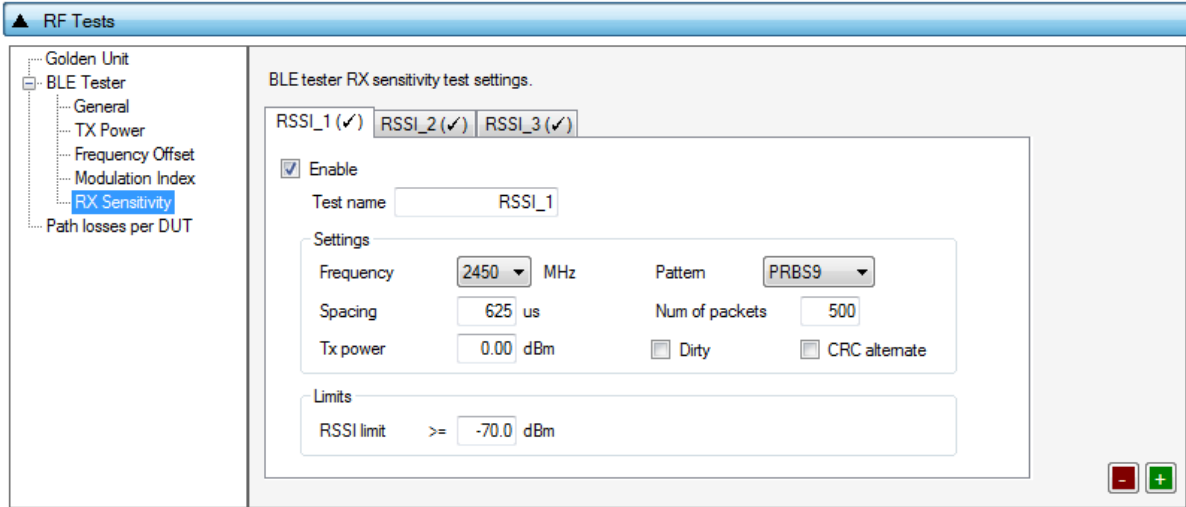

Figure 60: BLE Tester RX Sensitivity - DA1458x

Table 52 describes the available options for the *RX Sensitivity* test using a BLE Tester instrument.

Table 52: BLE Tester RX Sensitivity - DA1458x

Option	Description
Enable	This option enables the specific RX sensitivity test using a BLE tester instrument.
Test name	The name assigned to each test. The assigned name will be shown on the tab and next to it an indication showing whether the specific test is enabled or not.
Frequency	The BLE channel frequency used in the BLE RX sensitivity test.
Pattern	The bit pattern of the TX data. Available options are: <ul style="list-style-type: none"> • PRBS9 • 10101010 • 11110000
Spacing	The packet spacing in μ s.
Num of packets	The number of packets the BLE tester instrument to transmit.
Tx power	The TX output power of the BLE tester instrument. Suggested values are 0 to -10 dBm.
Dirty	When enabled, the BLE tester packet generator can use a dirty table to transmit.
CRC alternate	When enabled, the BLE tester will alternately send packets with CRC correct and CRC incorrect.
RSSI limit	The RSSI limit for pass/fail criteria in the RF RX sensitivity test. If the average RSSI of the device after it has received the transmitted packets is less than this value, the test will be considered as failed.

Path Losses per DUT

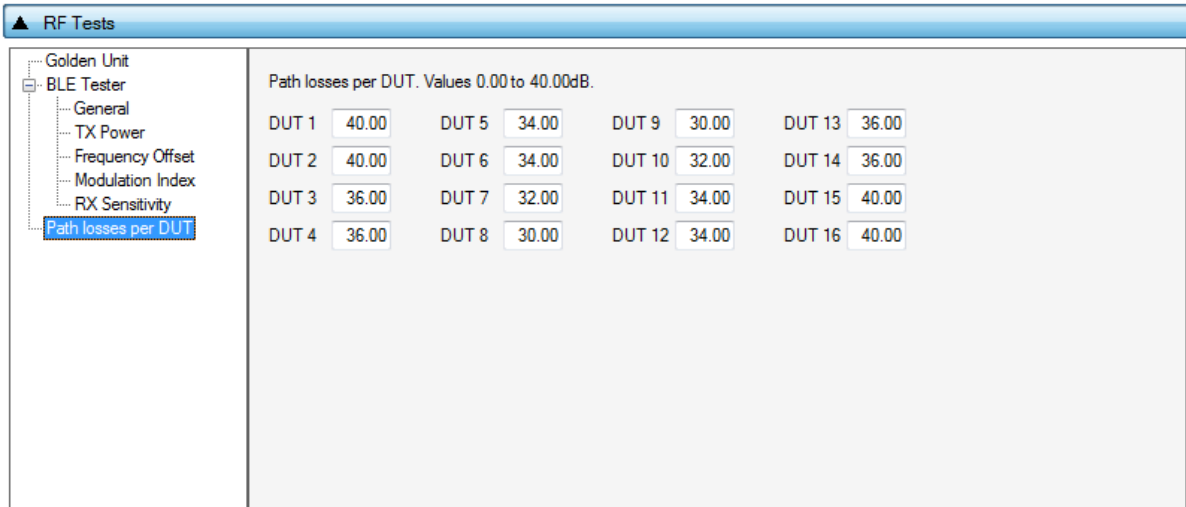

Figure 61: Path Losses per DUT - DA1458x

Table 53 describes the available options for the *Path losses per DUT*.

Based on the relative position of each DUT during the RF tests and since the RF tests are performed over the air, values can be used to correct for any path losses. These values are added to the limits of the TX Power and RF RX RSSI tests. Additional information can be found in [Appendix D](#) and [Appendix E](#).

Table 53: Path Losses per DUT from RF Tests DA1458x Options

Option	Description
DUT1-16	Set the calibrated path loss value for each DUT. These will be added as corrections to the limits of the TX Power and RF RX RSSI tests.

7.2.6.5 GPIO/LED Test

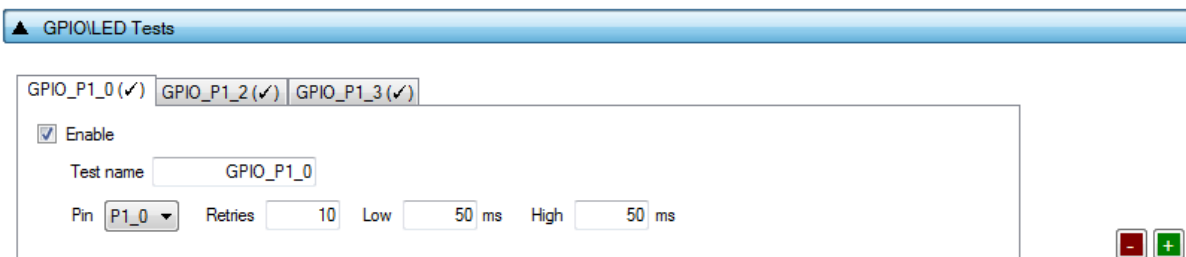

Figure 62: GPIO/LED Tests - DA1458x

GPIO/LED Tests can have multiple instances with different settings. Tests can be added or removed using the two buttons (e.g. and in [Figure 62](#)) at the bottom right side of each panel.

Note: When adding or removing a test, all settings are refreshed with the values written to the XML file, meaning that any unsaved settings will be lost.

Table 54 describes the available options for the *GPIO/LED Tests* DA1458x Options.

In these tests, a specific pulse can be given to a GPIO and any LED connected to it can be visually tested. The *Pin* option sets the GPIO to be used, *Low* and *High* define the duty cycle and the *Retries* the number of pulses.

DA1458x/DA1468x Production Line Tool

Table 54: GPIO/LED Tests - DA1458x

Option	Description
Enable	This option enables the GPIO/LED toggling. Can be used for visual LED testing.
Test name	The name assigned to each test. The assigned name will be shown on the tab and next to it an indication showing whether the specific test is enabled or not.
Pin	The GPIO that will be used for the specific test.
Retries	Number of pulses to be generated for the specific test.
Low	Sets the amount of the OFF time of the pulse in ms for the specific test.
High	Sets the amount of the ON time of the pulse in ms for the specific test.

7.2.6.6 GPIO Connection Test

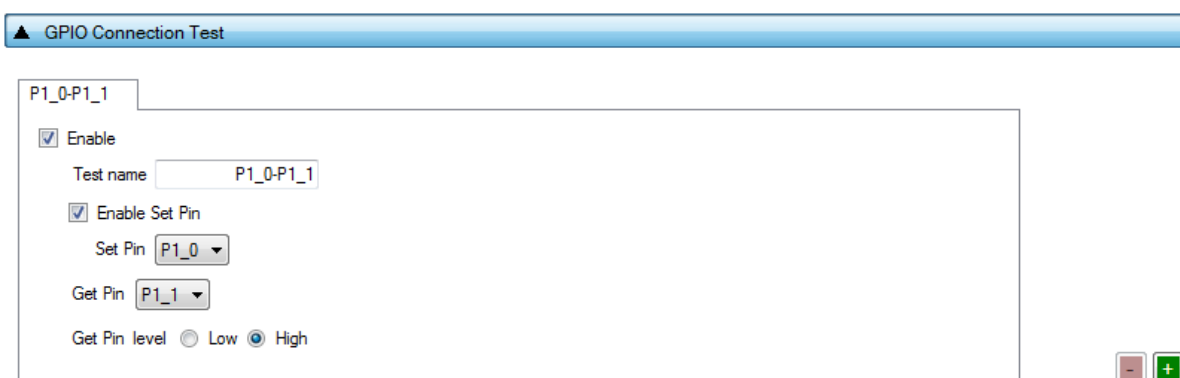

Figure 63: GPIO Connection Test - DA1458x

GPIO Connection Tests can have multiple instances with different settings. Tests can be added and removed using the two buttons (e.g. and in Figure 63) at the bottom right side of each panel.

Note: When adding or removing a test all settings are refreshed with the values written to the XML file, meaning that any unsaved settings will be lost.

Table 55 describes the available options for the DA1458x GPIO Connection Test.

When enabled, the PLT software will check the connection of specified GPIO (Get Pin) by either checking its state or the connection with another pin (Set Pin). In the latter case, the user gives the Set Pin and the state to check.

Table 55: GPIO Connection Test - DA1458x

Option	Description
Enable	This option enables the specific custom test.
Test name	The name assigned to each test. The assigned name will be shown on the tab and next to it an indication showing whether the specific test is enabled or not.
Enable Set Pin	Enables the use of the secondary GPIO to drive the GPIO under test. When this option is set, the Get Pin level option will be disabled.
Set Pin	Sets the GPIO to be used as a Set Pin.
Get Pin	Sets the GPIO to be tested.
Get Pin level	Sets the GPIO state the test awaits to see in the Get Pin. This option is disabled if the Set Pin mode is enabled.

DA1458x/DA1468x Production Line Tool

7.2.6.7 Audio Test

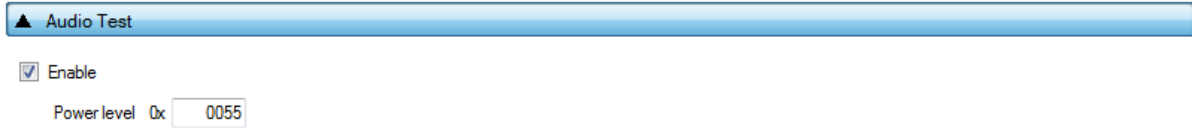

Figure 64: Audio Test

Table 56 describes the available options for the *Audio Test* Trim DA1458x Options.

Enabling this test will set the DUTs to listen for a 4 kHz tone produced by the GU. The DUT will send the audio data received to the PLT software. The PLT software will decode them, analyze if a 4 kHz tone exists in the audio data, and calculate the *Power Level*. If the tone is not detected or if the power level calculated is less than the one entered as limit the test will fail.

In order to perform the audio test an external speaker should be connected to the GU as shown in [Appendix N](#).

Note: Audio test is supported only for DA14582, DA14585 and DA14586 devices.

Table 56: Audio Test

Option	Description
Enable	This option enables the audio testing.
Power level	The threshold limit of the power level calculated for the 4 kHz tone.

7.2.6.8 Sensor Test

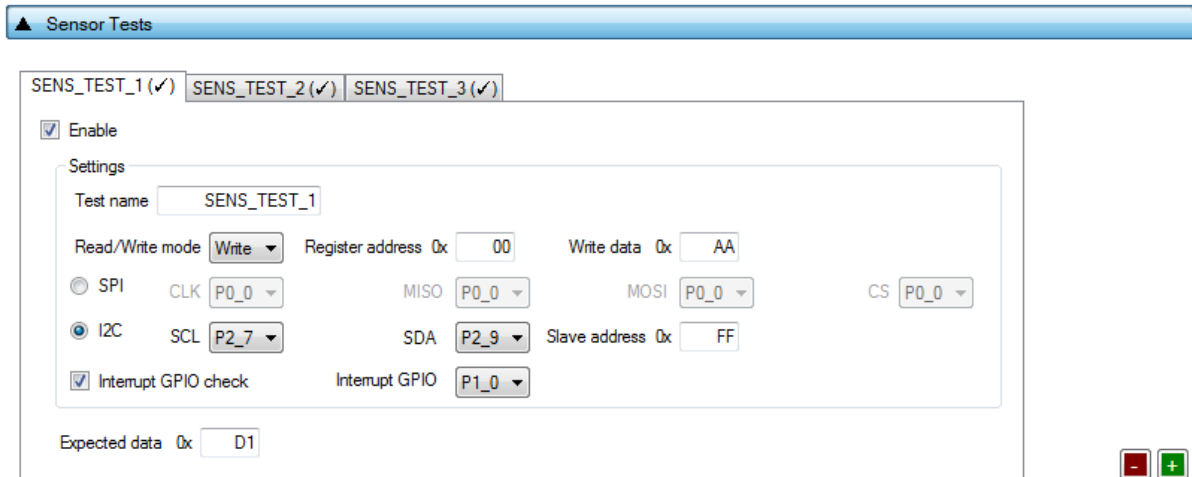

Figure 65: Sensor Test - DA1458x

Sensor Tests can have multiple instances with different settings. Tests can be added and removed using the two buttons (e.g. and in [Figure 65](#)) at the bottom right side of each panel.

Note: When adding or removing a test all settings are refreshed with the values written to the XML file, meaning that any unsaved settings will be lost.

Table 57 describes the available options for the *Sensor Tests* DA1458x Options.

Table 57: Sensor Tests - DA1458x

Option	Description
Enable	This option enables the specific sensor test.

DA1458x/DA1468x Production Line Tool

Option	Description
Test name	The name assigned to each test. The assigned name will be shown on the tab and next to it an indication showing whether the specific test is enabled or not.
Read / Write mode	Select the sensor test procedure, to read or write.
Register address	The sensors register address to read or write data.
Write data	The byte to be written at the sensor register.
SPI / I2C	Select the interface that the sensor is connected to.
SPI - CLK	Select the GPIO for the sensor SPI CLK.
SPI - MISO	Select the GPIO for the sensor SPI MISO.
SPI - MOSI	Select the GPIO for the sensor SPI MOSI.
SPI - CS	Select the GPIO for the sensor SPI CS.
I2C - SCL	Select the GPIO for the sensor I2C SCL.
I2C - SDA	Select the GPIO for the sensor I2C SDA.
Slave address	The sensor I2C bus slave address.
Interrupt GPIO check	Enables the sensor interrupt signal test via GPIO.
Interrupt GPIO	Select the GPIO to be used as a sensor interrupt.
Expected data	The received sensor byte that will be expected on a successful operation.

7.2.6.9 Custom Test

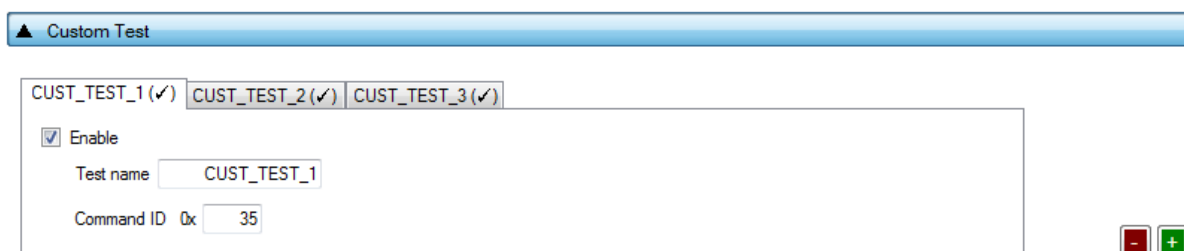



Figure 66: Custom Test - DA1458x

Custom Tests can have multiple instances with different settings. Tests can be added and removed using the two buttons (e.g.  and  in Figure 66) at the bottom right side of each panel.

Note: When adding or removing a test all settings are refreshed with the values written to the XML file, meaning that any unsaved settings will be lost.

Table 58 describes the available options for the DA1458x *Custom Tests*.

When enabled, the PLT software will send an HCI command via the UART to activate a customer defined test that will run on the DUTs. The HCI custom test command will contain a single byte as data (the *Command ID* byte), to be used mainly as identification for a specific test in the customized firmware. Default functionality of the production test firmware is to respond with the same *Command ID*. Otherwise, PLT will consider the test as failed.

Table 58: Custom Tests - DA1458x

Option	Description
Enable	This option enables the specific custom test.
Test name	The name assigned to each test. The assigned name will be shown on the tab and next to it an indication showing whether the specific test is enabled or not.

DA1458x/DA1468x Production Line Tool

Option	Description
Command ID	The byte that will be sent to the device running the production test firmware.

7.2.6.10 External 32kHz Test

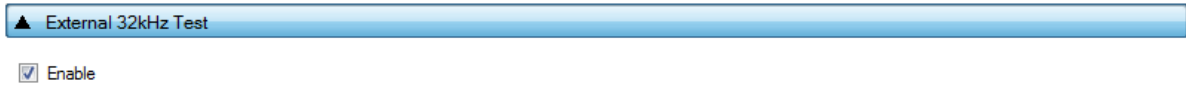

Figure 67: External 32kHz Test - DA1458x

Table 59 describes the available options for the DA1458x *External 32kHz Test*.

When enabled, the PLT software will verify the correct operation of the External 32kHz crystal on each DUT.

Table 59: External 32kHz Test - DA1458x

Option	Description
Enable	This option enables the External 32kHz test.

DA1458x/DA1468x Production Line Tool

7.2.6.11 Current Measurement Test

▲ Current Measurement Test

Current measurement general settings

Enable

Instrument Settings

Instrument: ammeter_scpi.dll

Interface: GPIB0::16

Peripheral Current Measurement

Periph Test 1 (✓) Periph Test 2 (✓) Periph Test 3 (✓)

Enable

Test name:

Ammeter Setup

Settings

Shunt resistor: 0.00 Ohms Wait time: 2000 mSecs

Range: 0.001 Amps Resolution: 0.0001 Amps

Samples: 10 SCPI cmd: CURR:DC:NPLC 1

Limits per device

Upper limit <= 0.00 Amps Total limit value of 1 DUTs is 0.

Low limit >= 0.00 Amps Total limit value of 1 DUTs is 0.

Test Options

GPIO GPIO Pin: P0_0 GPIO state: High

PWM frequency: 0 KHz PWM duty: 0 %

Custom Test Custom test Start Command ID 0x 00 Stop Command ID 0x 00

Sleep Current Measurement

Enable

Settings

Sleep mode: Extended Deep

Shunt resistor: 0.00 Ohms Wait time: 2000 mSecs Sleep time: 5 Secs

Range: 0.001 Amps Resolution: 0.0001 Amps Up to 1200s of sleep time is supported.

Samples: 10 SCPI cmd: CURR:DC:NPLC 1

Limits per device

Upper limit <= 0.000002 Amps Total limit value of 1 DUTs is 2E-06.

Low limit >= 0.0000017 Amps Total limit value of 1 DUTs is 1.7E-06.

Figure 68: Current Measurement Test - DA1458x



In this test, an external ammeter instrument can be used to calculate the total current consumption of all the active DUTs at the time of the sampling. The ammeter instrument can be connected in the blue banana plugs as described in [Current Measurements](#) or to an external power supply (if present) depending the selected [VBAT/Reset Mode](#).

During measurement, PLT will control the instrument using the `ammeter_driver` DLL [1]. [Table 60](#) describes the instrument selection settings found by the `ammeter_driver` DLL, [Table 61](#) describes the settings used for each of the peripheral current measurement tests and [Table 62](#) describes the current measurement options for each sleep state.

DA1458x/DA1468x Production Line Tool

Note: Modifications in the production test firmware are mandatory in order to achieve the correct current consumption of a specific hardware design. Running the default firmware without any modifications may result in increased current consumption.

Note: During sleep current measurement test, if the measurement taken is outside of the limits set, PTL will reset all devices and begin a firmware download and current measurement to each device separately, using the limits set for a single device, in order to identify which device failed.

Peripheral Current Measurement Tests can have multiple instances with different settings. Tests can be added and removed using the two buttons (e.g.  and  in [Figure 68](#)) at the bottom right side of each panel.

Note: When adding or removing a test all settings are refreshed with the values written to the XML file, meaning that any unsaved settings will be lost.

Table 60: Current Measurement Test – Instrument Settings - DA1458x

Option	Description
Enable	This option enables all of Current Measurement tests, which include: <ul style="list-style-type: none"> • Idle Current Measurement • Extended Sleep Current Measurement • Deep Sleep Current Measurement Only one of the Extended/Deep sleep current measurements can be selected, meaning that the other one will be disabled.
Instrument	Select the Ammeter instrument DLL name. Names are shown only if an ammeter instrument DLL exists in the project <code>ammeter_instr_plugins</code> folder.
Interface	The interface of the instrument to be used by the driver.

Table 61: Current Measurement Test – Peripheral Current Measurement - DA1458x

Option	Description
Enable	This option enables the specific peripheral current measurement test.
Test name	The name assigned to each test. The assigned name will be shown on the tab and next to it an indication showing whether the specific test is enabled or not.
Shunt resistor	The value of the shunt resistor used for peripheral measurement. Applicable only if a voltmeter or a NI-DAQ is used to measure current instead of a DMM. Values from 0 to 9999 are supported.
Wait time	The time in ms the PLT will wait before taking a current measurement, after it has sent an instruction to the DUTs to go into sleep state. Supported values are 1 to 500000ms.
Range	The range value in Ampere units that the ammeter instrument will operate. Supported values are 0 to 9999 and default value is 0.001A. When the <code>ammeter_scpi.dll</code> is used, if this value is set to zero, the instrument will use automatic range functionality.
Resolution	The ammeter instrument resolution value in Ampere units.
Samples	The number of samples that the ammeter instrument will read and average. 1 to 1000 is supported.
SCPI cmd	A SCPI command to be passed to the ammeter instrument just before the measurement is taken. Supports multiple commands separated with a column. Up to 256 characters are supported.

DA1458x/DA1468x Production Line Tool

Option	Description	
Upper limit	<p>The upper limit value for the peripheral current measurement test procedure, for a single DUT.</p> <p>Next to this input field the total upper limit current consumption for all the enabled DUTs is shown, which is the value to be used during testing.</p> <p>Note: During testing, some DUTs may fail until the current measurement test takes place. In that case, the PLT will automatically re-calculate the total upper limit by using the value given for a single DUT multiplied with the number of the active DUTs at the time that the test will run.</p>	
Low limit	<p>The low limit value for the peripheral current measurement test procedure, for a single DUT.</p> <p>Next to this input field the total upper limit current consumption for all the enabled DUTs is shown, which is the value to be used during testing.</p> <p>Note: During test, some DUTs may fail until the current measurement test takes place. In that case, the PLT will automatically re-calculate the total low limit by using the value given for a single DUT multiplied with the number of the active DUTs at the time that the test will run.</p>	
Test Options	<p>Select between a PWM GPIO test and custom test.</p> <p>Note: For the custom tests to work, a modified production test firmware must be created with tests that set the DUTs to specific states before the current measurement test. Each test must be assigned to a specific opcode. The custom tests are the exact same as in Custom Test.</p>	
Test Options - GPIO	Pin	Sets the GPIO to toggle with the PWM pulse.
	GPIO state	Sets the active state of the GPIO.
	PWM frequency	Sets the PWM frequency.
	PWM duty	Sets the PWM duty cycle.
Test Options – Custom Test	Start Command ID	The opcode of the custom test that sets the state of the DUT.
	Stop Command ID	The opcode of the custom test that restores the DUT to its original state.

Table 62: Current Measurement Test - Sleep Current Measurement - DA1458x

Option	Description
Enable	This option enables the specific current measurement using the ammeter instrument provided in the <i>Instrument</i> section.
Shunt resistor	The value of the shunt resistor used for sleep current measurement. Applicable only if a voltmeter or a NI-DAQ is used to measure current instead of a DMM. Values from 0 to 9999 are supported.
Wait time	The time in ms the PLT will wait before taking a current measurement, after it has sent an instruction to the DUTs to go into a specific sleep state. Supported values are 1 to 500000ms.
Sleep time	The time in seconds that the DUTs will remain in sleep mode. A timer in the production test firmware will wake up the devices. Supported values are 1 to 9sec for DA14580/1/2/3 and up to 1200sec for the rest.
Range	The range value in Ampere units that the ammeter instrument will operate. Supported values are 0 to 9999 and default value is 0.001A. When the <code>ammeter_scpi.dll</code> is used, if this value is set to zero, the instrument will use the automatic range functionality.
Resolution	The ammeter instrument resolution value in Ampere units.
Samples	The number of samples that the ammeter instrument will read and average. 1 to 1000 is supported.
SCPI cmd	An SCPI command to be passed to the ammeter instrument just before the measurement is taken. Supports multiple commands separated with a column. Up to 256 characters are supported.

DA1458x/DA1468x Production Line Tool

Option	Description
Upper limit	The upper limit value for the sleep current measurement test procedure, for a single DUT. Next to this input field the total upper limit current consumption for all the enabled DUTs is shown, which is the value to be used during testing. Note: During test, some DUTs may fail until the current measurement test takes place; in that case, the PLT will automatically re-calculate the total upper limit by using the value given for a single DUT multiplied with the number of the active DUTs at the time that the test will run.
Low limit	The low limit value for the sleep current measurement test procedure, for a single DUT. Next to this input field the total upper limit current consumption for all the enabled DUTs is shown, which is the value to be used during testing. Note: During testing, some DUTs may fail until the current measurement test takes place. In that case, the PLT will automatically re-calculate the total low limit by using the value given for a single DUT multiplied with the number of the active DUTs at the time that the test will run.

7.2.6.12 Temperature Measurement Test

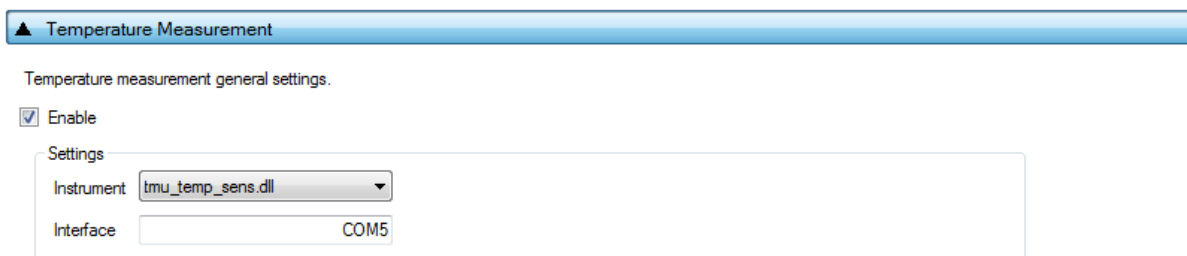

Figure 69: Temperature Measurement Test - DA1458x

Table 63 describes the available options of the DA1458x *Temperature Measurement Test*.

Table 63: Temperature Measurement Test - DA1458x

Option	Description
Enable	This option enables the temperature measurement test.
Instrument	Selects the temperature measurement DLL. Names are shown only if a temperature measurement instrument DLL exists in the project folder <code>temp_meas_instr_plugins</code> .
Interface	The interface of the instrument to be used by the driver.

7.2.6.13 Scan Test

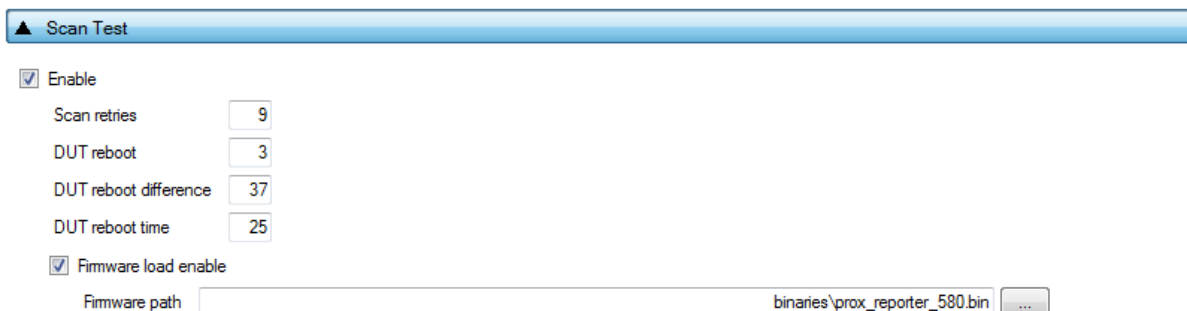

Figure 70: Scan Test - DA1458x

Table 64 describes the available options for the DA1458x *Scan Test*.

DA1458x/DA1468x Production Line Tool

By enabling this test, the Golden Unit will scan for the DUT's BD addresses advertised after the customer firmware has been burned. For this test to work, a bootable firmware with the ability to advertise with the BD address given by the PLT must be burned into each DUT. Additionally, the BD addresses provided by the PLT should be burned into OTP memory, such that the devices advertise with the BD addresses that the tool uses.

Table 64: Scan Test DA1458x Options

Option	Description
Enable	This option enables the Scan test.
Scan retries	The total number of BLE advertising scans the Golden Unit will perform.
DUT reboot	Define after how many retries the PLT will reboot the DUTs.
DUT reboot difference	Set the time difference between each DUT when the PLT reboots the devices, in order to avoid air collisions.
DUT reboot time	The time the VBAT will remain low during the device reboot. This value is time in ms*100 (e.g. 15 is 1500ms).
Firmware load enable	By enabling this option, a new image will be downloaded to all active DUTs before scanning for BLE advertising devices.
Firmware path	The path of the binary file to download to the devices for the scan test.

DA1458x/DA1468x Production Line Tool

7.2.7 Memory Functions (DA1458x)

This section describes the Memory Functions settings available when using DA1458x devices. Memory functions include OTP, SPI Flash, and I2C EEPROM memory programming.

7.2.7.1 OTP Memory

This test enables the OTP memory programming. Table 65 describes the available options for the OTP Memory image write operation.

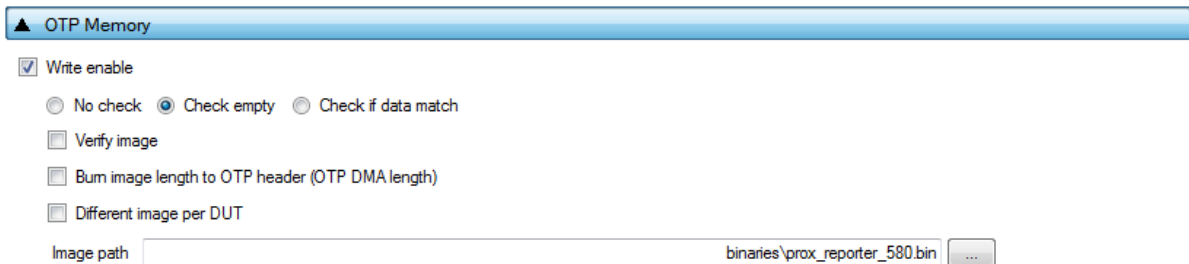

Figure 71: OTP Memory - DA1458x

Note: If the binary is larger than the available OTP image area (OTP memory excluding the header area), the PLT software will split the binary into two parts. The first part will contain only the OTP image area. The second part will contain the OTP header fields, split in OTP words. PLT will burn the non-zero words one by one, as single OTP entries in the OTP header area. The check empty feature will handle the first part as an OTP image binary. The second part will be checked word by word.

Table 65: OTP Memory - DA1458x

Option	Description
Write enable	This option enables the OTP image write operation.
<ul style="list-style-type: none"> No check Check empty Check if data match 	Memory protection options: No check: No protection is enabled. PLT will attempt to burn the OTP memory without running any check. Check empty: PLT will first check if the OTP memory is empty. Check if data match: PLT will first check if the memory to be burned is empty. If it is not, it will compare the contents with the data to be burned. If the data are not the same the test will fail without making any changes to the memory. If the data are the same, PLT will not burn the memory to prevent using the OTP repair memory.
Verify image	If this option is enabled, PLT will read back the contents of the OTP memory and compare them to the original image file. If these do not match it will fail.
Burn image length to OTP header (OTP DMA length)	If this option is selected, PLT software will calculate the length in OTP words and burn it to the Memory Header (DA1458x) – OTP DMA length. When selected, it will disable the OTP DMA length option in Memory header tab.
Different image per DUT	If this option is selected, a different image per DUT can be burned into the OTP. The image name must be specific for each DUT, as described below.
Image path	Via this field, the user specifies the image file to be burned into the OTP. A .bin binary file of any name can be selected. Depending on the size of the selected binary, PLT will inform the user if the binary contains both the image and the header part or if it exceeds the maximum supported size. If <i>Different image per DUT</i> is selected, the user only selects the directory of the images. In that case, the binary file names must have the following format: <i>img_xx.bin</i> , where 'X' denotes the DUT number. For example, if the user has activated DUTs 1, 5 and 10 then <i>img_01.bin</i> , <i>img_05.bin</i> and <i>img_10.bin</i> binary files should exist in the selected OTP image path as shown in Figure 72 . Range of numbers is <i>img_01.bin ... img_16.bin</i> .

DA1458x/DA1468x Production Line Tool

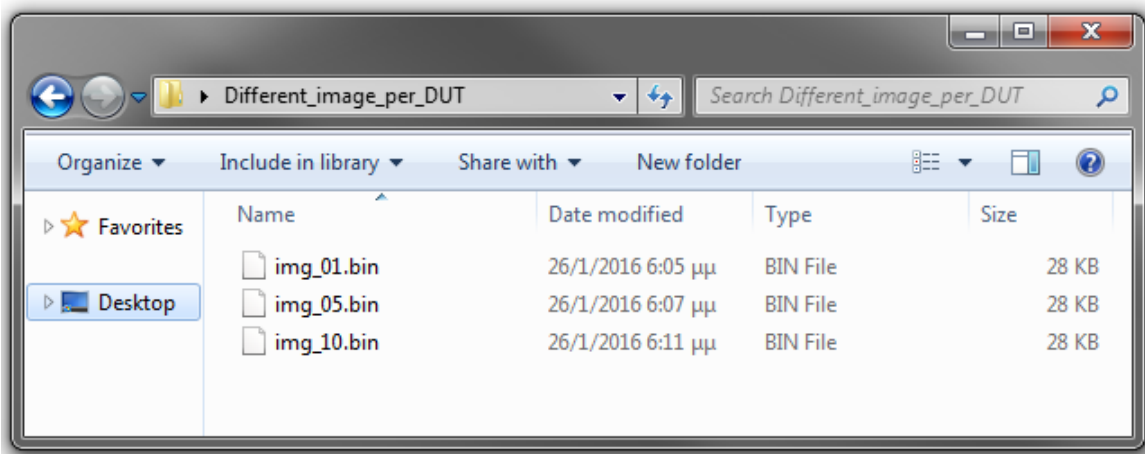

Figure 72: Different Image per DUT Folder Example

7.2.7.2 SPI Flash Memory

This section explains the settings of the SPI Flash Memory operations.

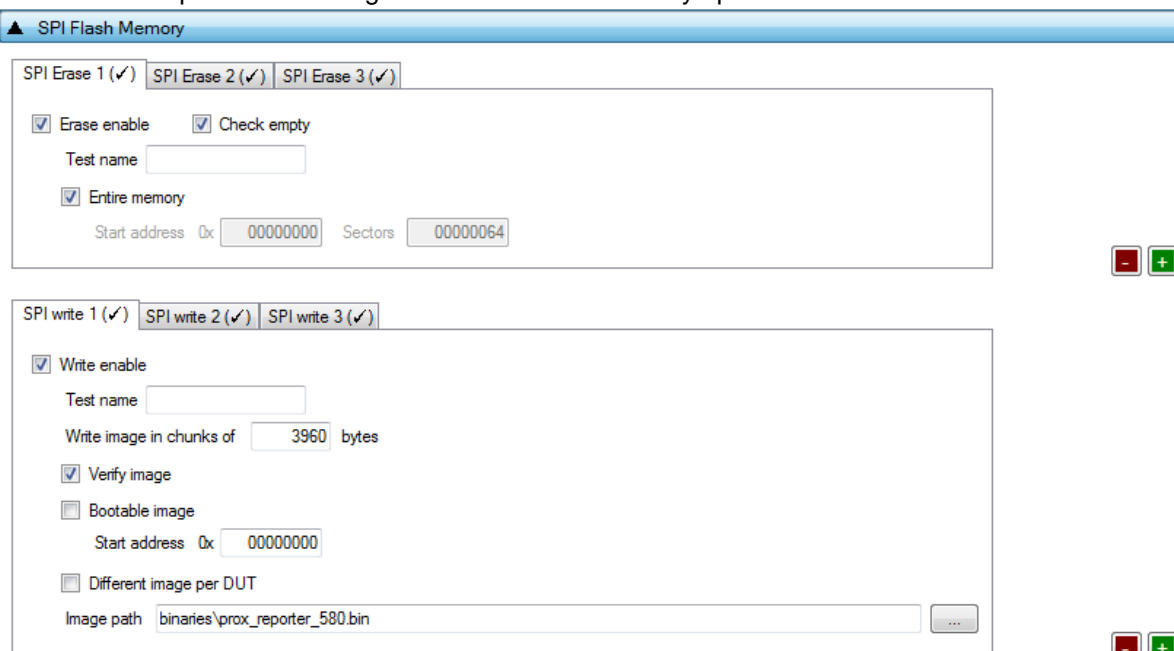

Figure 73: SPI Flash Memory - DA1458x

Both erase and write tests can have multiple instances with different settings. Tests can be added and removed using the two buttons (e.g. and in Figure 73) at the bottom right side of each panel.

Note: When adding or removing a test all settings are refreshed with the values written to the XML file, meaning that any unsaved settings will be lost.

The SPI Flash memory should be erased before any image is written to it. Table 66 describes the available options for the *SPI Flash Erase* operation.

Table 66: SPI Flash Erase - DA1458x

Option	Description
Erase enable	This option will enable the SPI flash erase operation.

DA1458x/DA1468x Production Line Tool

Option	Description
Check empty	After flash erasure, the PLT software can verify the erasure result by sending a specific command to the <code>flash_programmer.bin</code> firmware running in the DUT. The firmware will read the SPI flash memory and check if it is empty. The result will be returned to the PLT software.
Test name	The name assigned to each test. The assigned name will be shown on the tab and next to it an indication showing whether the specific test is enabled or not.
Entire memory	If selected, the entire memory will be erased. Otherwise, the user can give a start address and a specific number of sectors to be erased.
Start address	The user can enter a specific start address for the SPI flash erasure operation.
Sectors	The number of sectors to erase, starting from the <i>Start address</i> as explained above.

After all the SPI flash erase operations have finished, the SPI image write tests will begin. [Table 67](#) describes the available options for the *SPI Flash Image Write* operation.

Table 67: SPI Flash Image Write - DA1458x

Option	Description
Write enable	This will enable the specific SPI flash image programming operation.
Test name	The name assigned to each test. The assigned name will be shown on the tab and next to it an indication showing whether the specific test is enabled or not.
Write image in chunks of "user_input" bytes.	During memory programming, PLT will split the image into chunks of size defined in this field. Values from 1 byte to 32760 bytes are supported.
Verify image	By selecting this option, the PLT software will read back the contents of the SPI flash memory, after an image was burned. It will compare them to the original image file. If these do not match the SPI memory programming will fail.
Bootable image	Is this is enabled PLT will write a boot header at SPI address 0 and burn the image at SPI address 0x8.
Start address	Users can configure the SPI flash start address image write operation. If <i>Bootable image</i> is selected, this option is disabled.
Different image per DUT	If this option is selected, a different image per DUT will be burned into the SPI flash. The image name must be specific for each DUT, as described below.
Image path	Via this field, the user specifies the image file to be burned into the SPI Flash memory. A <code>.bin</code> binary file of any name can be selected. If option <i>Different image per DUT</i> is selected the user only selects the directory of the images. In that case, the binary file names must have the following format: <code>img_0X.bin</code> , where 'X' denotes the DUT number. For example, if the user has activated DUTs 1, 5 and 10 then <code>img_01.img</code> , <code>img_05.img</code> and <code>img_10.img</code> binary files should exist in the selected SPI image path, as shown in Figure 72 .

7.2.7.3 I2C EEPROM Memory

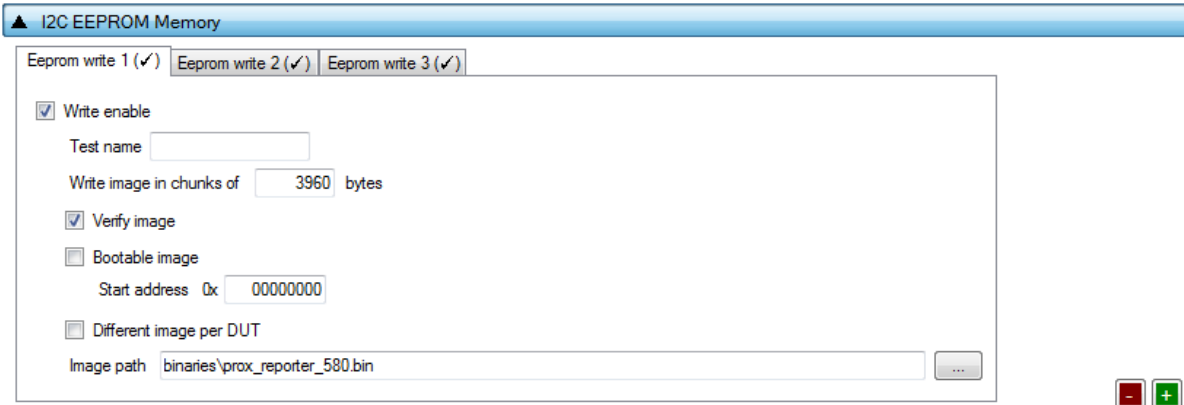



Figure 74: I2C EEPROM Memory - DA1458x

In this section, an I2C EEPROM memory can be programmed. The I2C EEPROM image write tests can be performed multiple times with different settings each time. Tests can be added and removed using the two buttons (e.g.  and  in Figure 74) at the bottom right side of each panel.

Note: When adding or removing a test all settings are refreshed with the values written to the XML file, meaning that any unsaved settings will be lost.

Table 68 describes the available options for the *I2C EEPROM Image Write* operation.

Table 68: I2C EEPROM Image Write - DA1458x

Option	Description
Write enable	This will enable the specific I2C/EEPROM image programming test.
Test name	The name assigned to each test. The assigned name will be shown on the tab and next to it an indication showing whether the specific test is enabled or not.
Write image in chunks of “user_input” bytes.	During memory programming, PLT will split the image into chunks of size defined in this field. Values from 1 byte to 32760 bytes are supported.
Verify image	By selecting this option, the PLT software will read back the contents of the EEPROM and compare them to the original image file. If these do not match the EEPROM memory programming will fail.
Bootable image	Is this is enabled PLT will write a boot header at EEPROM address 0 and burn the image at the EERPOM address 0x20.
Start address	Users can configure the EEPROM start address image write operation. If <i>Bootable image</i> is selected, this option is disabled.
Different image per DUT	If this option is selected, a different image per DUT will be burned into the EEPROM memory. The image name must be specific for each DUT, as described below.
Image path	This field specifies the image file to be burned into the EEPROM memory. A .bin binary file of any name can be selected. If option <i>Different image per DUT</i> is selected, the user only selects the directory of the images. In that case, the binary file names must have the following format: <i>img_0X.bin</i> , where ‘X’ denotes the DUT number. For example, if the user has activated DUTs 1, 5 and 10 then <i>img_01.img</i> , <i>img_05.img</i> and <i>img_10.img</i> binary files should exist in the selected image path, as shown in Figure 72.

DA1458x/DA1468x Production Line Tool

7.2.7.4 Memory read

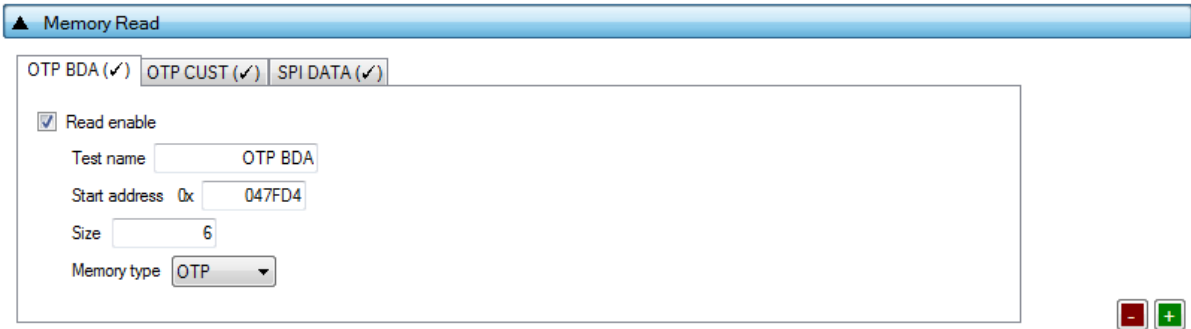

Figure 75: Memory Read Test - DA1458x

Memory Read Tests can have multiple instances with different settings. Tests can be added or removed using the two buttons (e.g. and in Figure 75) at the bottom right side of each panel.

Note: When adding or removing a test, all settings are refreshed with the values written to the XML file, meaning that any unsaved settings will be lost.

Table 69 describes the memory read test options. With this test, the user can read up to 256 bytes of data from any address and any available memory for the DA14580/1/2/3/5/6 devices, such as OTP, SPI Flash and EEPROM. An example of how the data appears in the log file is shown in Figure 76.

```
Memory read operation initialized. Memory read test name=[OTP BDA].
Memory read operation started. Memory read test name=[OTP BDA].
Memory read operation ended OK. Test name [OTP BDA]. Memory=[OTP]._Addr=[0x47fd4]. size=[6]. Data=[0a0000808080].
```

Figure 76: Memory Read Test Example Log File - DA1458x

Table 69: Memory Read Test - DA1458x

Option	Description
Read enable	This will enable the memory read test.
Test name	The name assigned to each test. The assigned name will be shown on the tab and next to it an indication showing whether the specific test is enabled or not.
Start address	Configures the start address for the read test. DA14580/1/2/3 OTP memory 0x40000 offset should be used (e.g. BD address is written in 0x47FD4). DA14585/6 OTP memory offset is at 0x0 (e.g. BD address is written in 0xFFA8). DA14580/1/2/3 OTP valid address is 0x40000 to 0x47FFF and DA14585/6 OTP address 0x0000-0x10000.
Size	Number of bytes to read, up to 256 bytes.
Memory type	The type of memory to read the data from. Available options are OTP, SPI FLASH, and I2C EEPROM. Note: For the SPI FLASH and EEPROM memories, the pin configurations are taken from the SPI Flash Configuration and I2C EEPROM Configuration sections.

DA1458x/DA1468x Production Line Tool

7.2.8 Memory Header (DA1458x)

This section describes the OTP header programming settings available when using DA14580, DA14581, DA14582, or DA14583 devices.

7.2.8.1 General

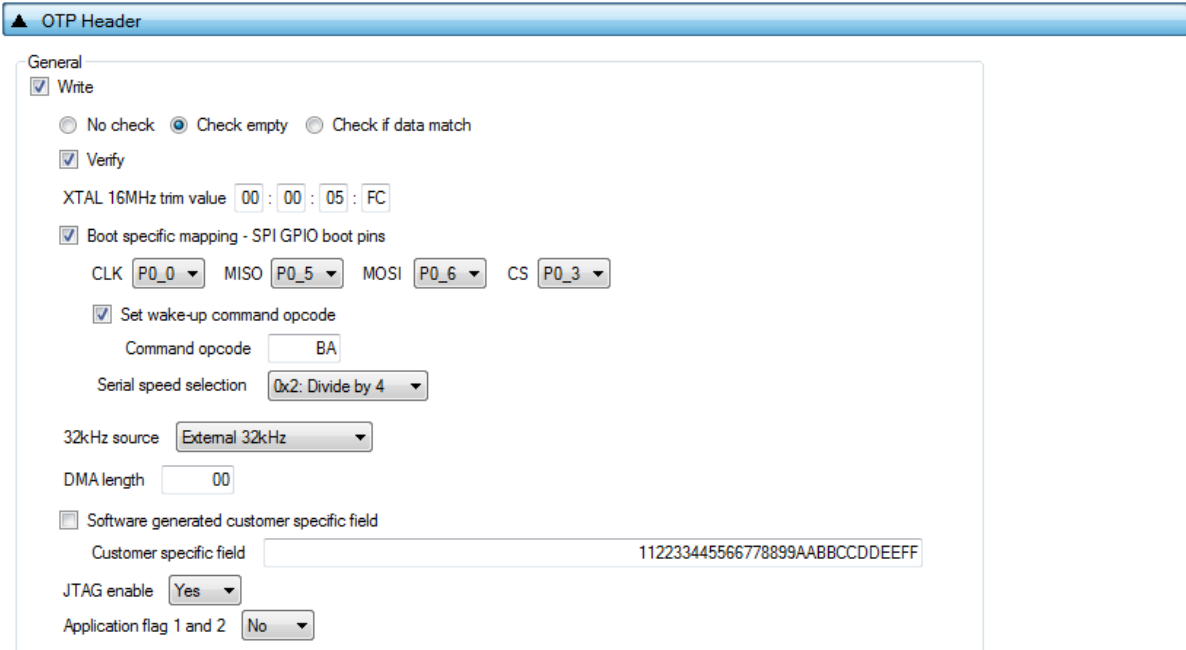

Figure 77: OTP Header - DA1458x

Table 70 describes the available options for DA1458x OTP Header programming.

Table 70: OTP Header - DA1458x

Option	Description
Write	This option enables the OTP header programming.
<ul style="list-style-type: none"> No check Check empty Check if data match 	Memory protection options: No check: No protection is enabled. PLT will attempt to burn the OTP memory without running any check. Check empty: PLT will first check if the OTP memory to be burned is empty. If it is empty will burn it. Check if data match: PLT will first check if the memory to be burned is empty. If it is not, it will compare the contents with the data to be burned. If the data are not the same the test will fail without making any changes to the memory. If the data are the same, PLT will not burn the memory to prevent using the OTP repair memory.
Verify	Read back each OTP header value and compared with the original one to verify a successful write.
XTAL trim calibration flag (Only for DA14580/1/2/3)	If Burn to OTP in XTAL Trim is selected, this option is disabled because the XTAL trim value and flag will be burned during the automatic calibration process. If these are not executed, users have the option to manually write the OTP XTAL trim value and enable the calibration flag here.
XTAL 16 MHz trim value	XTAL calibration value common to all devices. Can be burned only if the automatic XTAL calibration process and Burn to OTP in XTAL Trim are disabled and XTAL trim calibration flag is enabled (only for DA14580/1/2/3).

DA1458x/DA1468x Production Line Tool

Option	Description
Boot specific mapping – SPI GPIO boot pins (only for DA14585)	Enables external booting from a specific SPI interface configuration. This option also enables the following options for the SPI flash boot configuration for the DA14585 devices. Note: In DA14586, the boot specific mapping section is already pre-programmed with the internal SPI pins as described in Appendix K . If this is needed to be changed for DA14586 DUTs, this area can be written as a DA14585 device and it will be overridden using an OTP memory repair cell.
CLK (only for DA14585)	Sets the GPIO for the CLK pin of the SPI bus.
MISO (only for DA14585)	Sets the GPIO for the MISO pin of the SPI bus.
MOSI (only for DA14585)	Sets the GPIO for the MOSI pin of the SPI bus.
CS (only for DA14585)	Sets the GPIO for the CS pin of the SPI bus.
Set wake-up command opcode (only for DA14585)	Default wake-up command opcode is “AB”. If a different one is needed to be used, it can be set using this flag and the following field.
Command opcode (only for DA14585)	The command opcode to be used.
Serial speed selection (only for DA14585)	Division factor for SPI.
32 kHz source	Selects the low power 32 kHz clock source.
DMA length	The size (in words) for the DMA controller to copy from OTP to system RAM during boot. Should match the OTP image size. Max value for the DA14580-1-2-3 devices is 0x1FC0. Max value for the DA14585-6 devices is 0x3E00. Note: This option will be disabled if Burn image length to OTP header option in OTP Memory is enabled.
Software generated specific field	When enabled, a PLT software function will be called that will generate a customer specific field per DUT. Users can edit this function by adding their code for creating the customer specific field. For the CLI executable this function is called: <pre>int cli_sw_customer_field(_cfg_params *cfg_params_t);</pre> For the GUI executable the function is called: <pre>void gui_plt_sw_customer_field(_cfg_params *cfg_params_t);</pre>
Customer specific field	If option <i>Software generated customer specific field</i> is not set, the user can manually enter the value to be written into the DUT OTP. The same value will be programmed to all DUTs.
JTAG enable	Enable the JTAG support.
Application flag 1 and 2	If this option is set, the device will boot only from the OTP memory. Used for a production ready device. There is no other means to access the device apart from JTAG, if this is still enabled in the OTP header.

7.2.8.2 BD Address

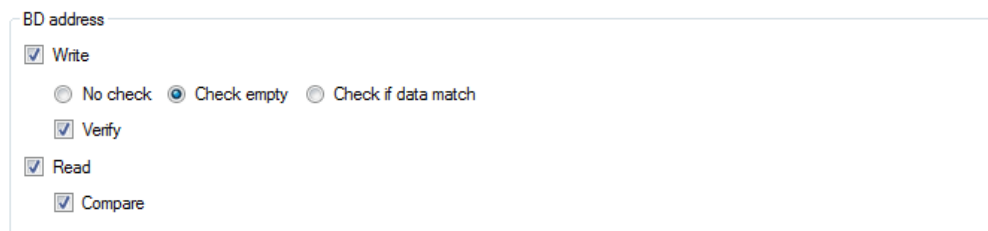

Figure 78: BD Address - DA1458x

The BD address can be written independently from the rest of the OTP header fields described before. [Table 71](#) describes the available options for the *BD Address* programming.

DA1458x/DA1468x Production Line Tool

Table 71: BD Address - DA1458x

Option	Description
Write	When selected, the BD address will be written in the OTP Header.
<ul style="list-style-type: none"> • No check • Check empty • Check if data match 	Memory protection options: No check: No protection is enabled. PLT will attempt to burn the OTP memory without running any check. Check empty: PLT will first check if the OTP memory to be burned is empty. If it is empty will burn it. Check if data match: PLT will first check if the memory to be burned is empty. If it is not, it will compare the contents with the data to be burned. If the data are not the same the test will fail without making any changes to the memory. If the data are the same, PLT will not burn the memory to prevent using the OTP repair memory.
Verify	When selected, the BD address will be read back from the OTP Header and will be compared to the original.
Read	This option will read the BD address written in the OTP Header field. It is a standalone memory operation. It does not depend on the previous tests to run, but it is necessary for the following <i>Compare</i> test.
Compare	If the <i>Read</i> option is enabled, a comparison will be performed between the read BD address and the BD address entered in the DUT by the PLT, as described in the BD address DUT assignment method.

7.2.8.3 Custom Memory Data

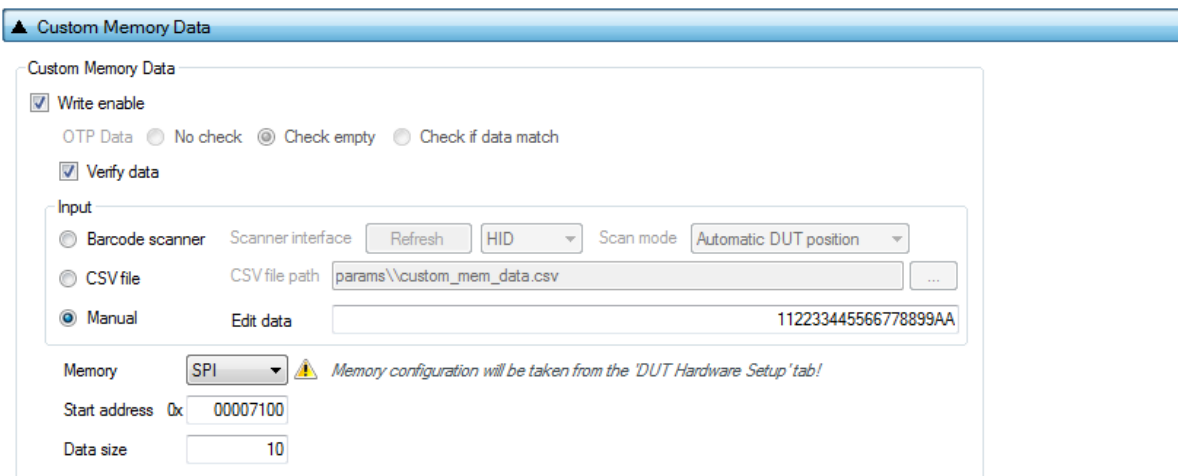

Figure 79: Custom Memory Data - DA1458x

Table 72 describes the *Custom Memory* data test options. With this test, the user can write any data to any address to any available memory for DA1458x devices, such as OTP, SPI flash and EEPROM. Data input modes can be a Barcode Scanner, a CSV file or data entered manually.

DA1458x/DA1468x Production Line Tool

Table 72: Custom Memory Data - DA1458x

Option	Description
Write enable	This option enables the custom data programming.
Verify data	When selected, the data written will be read back and compared to the original.
<ul style="list-style-type: none"> No check Check empty Check if data match (Only available when OTP memory or CSV file as input is selected)	Memory protection options: No check: No protection is enabled. PLT will attempt to burn the OTP memory without running any check. Check empty: PLT will first check if the OTP memory to be burned is empty. If it is empty will burn it. Check if data match: PLT will first check if the memory to be burned is empty. If it is not, it will compare the contents with the data to be burned. If the data are not the same the test will fail without making any changes to the memory. If the data are the same, PLT will not burn the memory to prevent using the OTP repair memory.
<ul style="list-style-type: none"> Barcode scanner CSV file Manual data 	<p>Note: Barcode scanner mode is only available with GUI PLT Application. CLI PLT Application does NOT support this feature.</p>
	Scanner interface (Barcode scanner) Selection of the Barcode scanner input. Both HID and COM port interfaces are supported. This list provides an HID and all available COM ports as selectable options. Any HID device is supported that includes newline (CR-LF) characters at the end of the scanned data. For the COM port interface, a common USB to UART barcode scanner is supported. PLT has been tested with Honeywell Xenon 1900. Appendix L describes the setup procedure. This option is the exact same option as in Scan Mode and the DA1468x devices in Custom Memory Data .
	Scan mode (Barcode scanner) Scan DUT position: In this mode, users must first scan the DUT position number and then the BD address. The string for the position of each DUT is "TEST POSITION 0xx". "xx" is the position number. Automatic DUT position: Scanned BD address will be assigned to the selected DUT. The DUT selection is automatically been made, starting from the first active DUT and selecting the next one after a successful BD address scan. Users can change the selected DUT using the controls on the GUI PLT screen shown in Figure 117 . This option is the exact same option as in Scan Mode and the DA1468x devices in Custom Memory Data .
	CSV file path (CSV file) Path to the CSV file containing data for each device discriminated using BD addresses. The CSV file format is described in Custom data CSV file format .
	Edit data (Manual data) Hexadecimal data input of up to 256 bytes. These data will be burned to all active DUTs.
Memory	Memory type selection to burn the data. Available options are OTP, SPI and EEPROM. Note: For the FLASH and EEPROM memories, the pin configurations are taken from the SPI Flash Configuration and I2C EEPROM Configuration sections. These options must be enabled in order for the <i>Memory Read</i> test to operate successfully.
Start address	Memory address offset to begin burning the data. DA14580/1/2/3 OTP valid address is 0x40000 to 0x47FFF and DA14585/6 OTP address 0x0000 – 0x10000.
Data size	The size of the memory data to burn. In barcode scanner, the data size is the number of scanned ASCII characters. In manual data, data size is the number of bytes.

DA1458x/DA1468x Production Line Tool

7.2.9 DUT Hardware Setup (DA1468x)

7.2.9.1 UART Boot Pins Setup

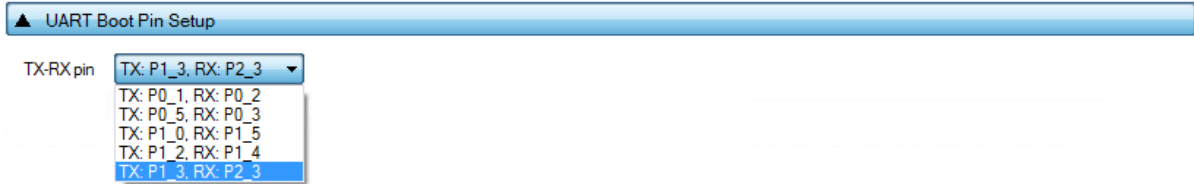

Figure 80: UART Boot Pins Setup - DA1468x

Table 73 describes the available options for the TX-RX pins of the DA1468x UART Boot Pins Setup. The TX-RX pins selection defines the UART pins and baud rate setup that will be used for firmware downloading to the DA1468x during booting.

Table 73: UART TX-RX Pins - DA1468x

Option	Description
TX: P0_1, RX: P0_2	Sets UART TX pin to P0_1, UART RX pin to P0_2 and Baud rate to 115200 bit/s.
TX: P0_5, RX: P0_3	Sets UART TX pin to P0_5, UART RX pin to P0_3 and Baud rate to 57600 bit/s.
TX: P1_0, RX: P1_5	Sets UART TX pin to P1_0, UART RX pin to P1_5 and Baud rate to 57600 bit/s.
TX: P1_2, RX: P1_4	Sets UART TX pin to P1_2, UART RX pin to P1_4 and Baud rate to 57600 bit/s.
TX: P1_3, RX: P2_3	Sets UART TX pin to P1_3, UART RX pin to P2_3 and Baud rate to 57600 bit/s.

Note: The baud rate is fixed during booting, since it is controlled by the device ROM bootloader.

Warning: Be sure the UART-connections are not set to port 0 when QSPI is used!

7.2.9.2 UART Baud Rate

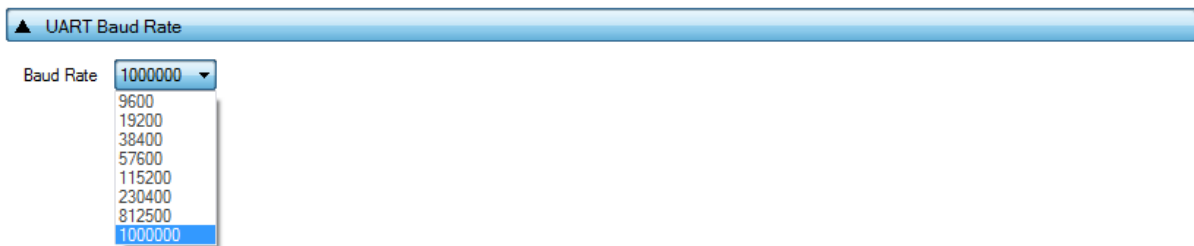

Figure 81: UART Baud Rate - DA1468x

Table 74 shows the available options for the DA1468x UART Baud Rate used during memory programming only.

The Baud Rate selected here is used after the firmware (uartboot_68x.bin) has been downloaded to the DUT. The software will send a command to the DUT to change the UART baud rate to the one selected. All following UART communications with the DUT will be performed using the new baud rate. Note that this is happening only during memory programming where uartboot_68x.bin is used. During tests (RF tests, XTAL trimming, etc.), where the production test firmware is used, the baud rate is fixed to 115200 bit/s.

DA1458x/DA1468x Production Line Tool
Table 74: UART Baud Rate - DA1468x

Option	Description
Baud Rate	<ul style="list-style-type: none"> ● 9600 (bit/s) ● 19200 (bit/s) ● 38400 (bit/s) ● 57600 (bit/s) ● 115200 (bit/s) ● 230400 (bit/s) ● 1000000 (bit/s) <p>Note: 1 Mbit/s is the fastest and safest with 0% baud rate error.</p>

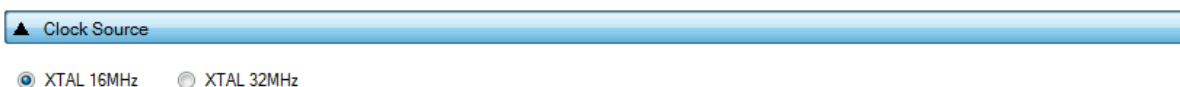
7.2.9.3 Clock Source**Figure 82: Clock Source - DA14682/3-00 Only**

[Table 75](#) describes the available options for the *Clock Source* selection. This option defines the type of the XTAL crystal used by the DA14682/3-00 DUTs. By selecting the XTAL 32MHz, PLT software will download and use the XTAL32MHz equivalent firmware files located in folder binaries.

Note: XTAL 16MHz is the default selection.

Note: Since the change applies in the firmware files, during booting sequence PLT will automatically double the baud rate to match the one DA14682/3 uses during firmware download, when running with the XTAL 32MHz crystal.

Note: For DUTs with XTAL 32MHz crystal, the [XTAL Trim](#) calibration uses a 300ms pulse instead of 500ms, generated by the PLT hardware.

Table 75: Clock Source - DA14682/3-00 Only

Option	Description
XTAL 16MHz / XTAL 32MHz	Select the XTAL frequency used on the DUTs.

7.2.10 Test Settings (DA1468x)

7.2.10.1 XTAL Trim

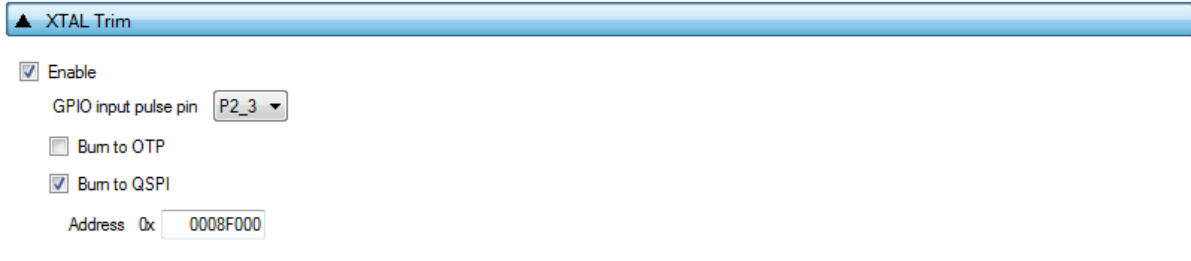

Figure 83: XTAL Trim - DA1468x

Table 76 describes the available options for the DA1468x XTAL Trim operation.

Table 76: XTAL Trim - DA1468x

Option	Description
Enable	This option enables the automatic crystal oscillator frequency calibration procedure.
GPIO input pulse pin	The DUT GPIO to receive the reference pulse during calibration. UART RX pin can be used without any additional connection from the PLT hardware to the DUT.
Burn to OTP	If <i>Burn to OTP</i> option is selected, the XTAL trim value calculated from the automated calibration process will be written in the OTP XTAL trim header field.
Burn to QSPI	If selected, the XTAL trim value calculated from the automated calibration process will be written in the QSPI Flash.
Address	The QSPI Flash address where the XTAL trim value will be written. Default value is 0x0008F000.

7.2.10.2 GPIO Watchdog operation

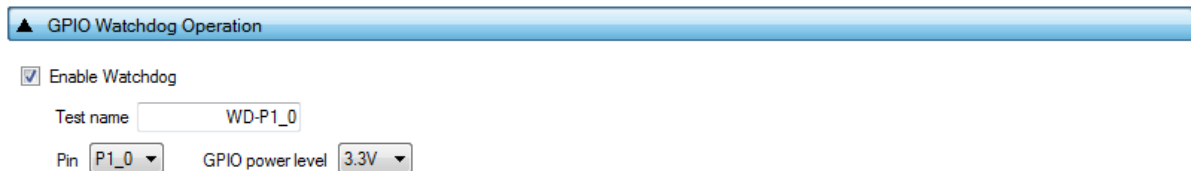

Figure 84: GPIO Watchdog operation - DA1468x

Table 77 describes the available options for the DA1468x GPIO Watchdog operation.

Table 77: GPIO Watchdog operation - DA1468x

Option	Description
Enable Watchdog	This option enables the continuous toggling of a GPIO during the whole production testing and memory programming procedure, except during firmware download. The pulse on the GPIO has approximately 0.75% duty cycle and 0.5Hz frequency. Note: Production test firmware can be downloaded through <code>uartboot_68x</code> firmware. After the <code>uartboot_68x</code> firmware is downloaded, the watchdog pin will be pulsed.
Test name	The name assigned for this test.
Pin	Select the GPIO that will be toggled.
GPIO power level	Sets the power level of the GPIOs.

7.2.10.3 Scan DUT Advertise Test

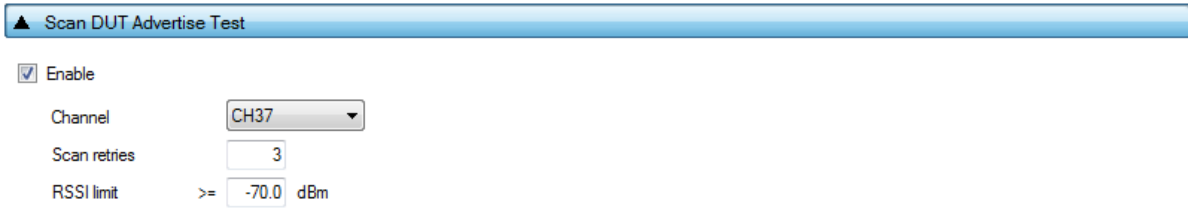

Figure 85: Scan DUT Advertise Test - DA1468x

Table 78 describes the available options for the DA1468x *Scan DUT Advertise Test* operation.

Table 78: Scan DUT Advertise Test - DA1468x

Option	Description
Enable	This option enables the <i>Scan DUT Advertise Test</i> operation.
Channel	The BLE channel frequency used in the RF RX test using the Golden Unit.
Scan retries	The number of retries to perform the test.
RSSI limit	The RSSI limit for pass/fail criteria in the RF RX test using the Golden Unit. If the average RSSI of the device, after it has received the packets transmitted from the Golden Unit is less than that the test will be considered as failed.

7.2.10.4 RF Tests

This section refers to various RF tests conducted between the DUTs and the Golden Unit or an external BLE tester.

The following tests can have multiple instances with different settings. Tests can be added and removed using the two buttons (e.g. and in Figure 86) at the bottom right side of each panel.

Note: When adding or removing a test all settings are refreshed with the values written to the XML file, meaning that any unsaved settings will be lost.

Golden Unit

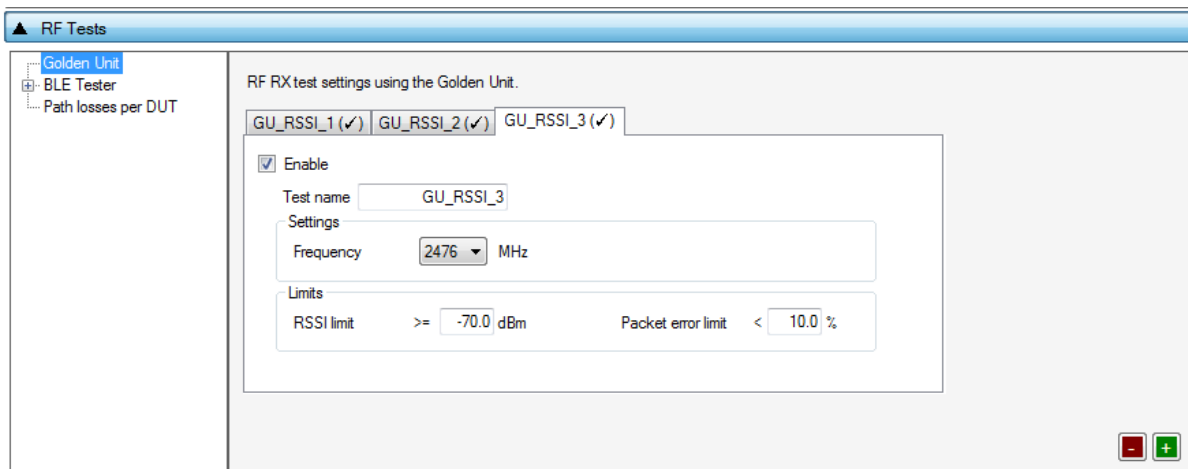

Figure 86: Golden Unit RF Tests - DA1468x

Table 79 describes the available options for the DA1468x *RF RX* test using the *Golden Unit* as a transmitter.

DA1458x/DA1468x Production Line Tool

In the RF RX test, the Golden Unit sends 500 packets. The DUTs are set in receive mode and the RSSI is measured. If the RSSI measured by the DUT reception is less than the specified *RSSI limit*, the device will fail and the tests will stop for that particular device.

Table 79: Golden Unit RF Tests - DA1468x

Option	Description
Enable	This option enables the specific RF RX test using the Golden Unit as a transmitter.
Test name	The name assigned to each test. The assigned name will be shown on the tab and next to it an indication showing whether the specific test is enabled or not.
Frequency	The BLE channel frequency used in the RF RX test using the Golden Unit.
RSSI limit	The RSSI limit for pass/fail criteria in the RF RX test using the Golden Unit. If the average RSSI of the device after it has received the packets transmitted from the Golden Unit is less than this value, the test will be considered as failed.
Packet error limit	This configures the PER limit for pass/fail criteria. If the percentage of the correct packets received is less than the value entered here, the test will fail.

BLE Tester

In the *BLE Tester* panels, a number of tests can be enabled that require an external BLE tester instrument. More detailed information about the BLE tester can be found in [1].

BLE Tester - General

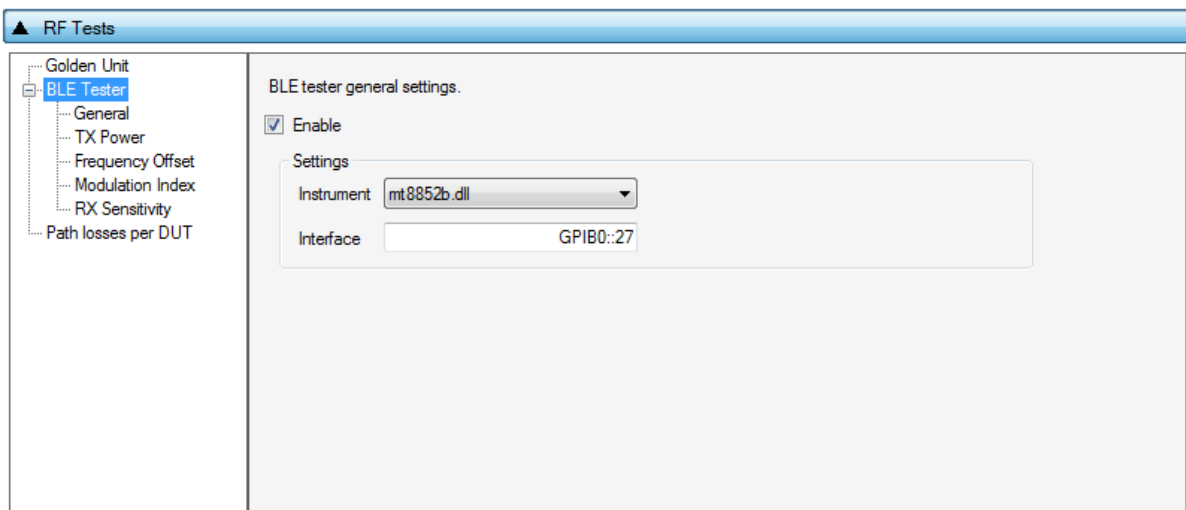

Figure 87: BLE Tester General Settings - DA1468x

Table 80 describes the *General* settings for the *BLE Tester* supported tests. Any available external instrument found by the `ble_tester_driver` DLL and their interfaces can be selected.

Table 80: BLE Tester General Settings - DA1468x

Option	Description
Enable	This option enables all of the <i>BLE Tester</i> tests, which include: <ul style="list-style-type: none"> • BLE Tester TX Power • Frequency Offset • Modulation Index • RX Sensitivity

DA1458x/DA1468x Production Line Tool

Option	Description
Instrument	Selects the BLE tester DLL. Names are shown only if a BLE tester instrument DLL exists in the project folder <code>ble_tester_instr_plugins</code> .
Interface	The interface of the instrument to be used by the driver.

BLE Tester - TX Power

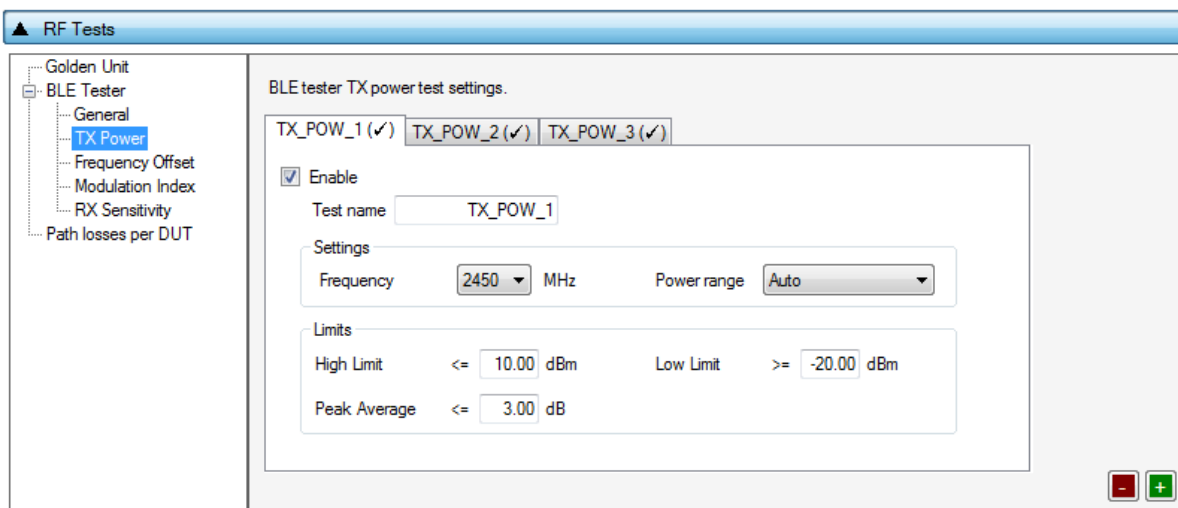

Figure 88: BLE Tester TX Power - DA1468x

Table 81 describes the available options for the DA1468x TX Power test using a BLE Tester instrument.

Table 81: BLE Tester TX Power - DA1468x

Option	Description
Enable	This option enables the specific TX power test using a BLE tester instrument.
Test name	The name assigned to each test. The assigned name will be shown on the tab and next to it an indication showing whether the specific test is enabled or not.
Frequency	The BLE channel frequency used in the BLE TX power test.
Power range	Set the device TX output power range. Available options are: <ul style="list-style-type: none"> • Auto (No auto option for Litepoint IQxel-M. Sets the instrument to trigger at -25dBm) • +22 dBm to +7 dBm • +9 dBm to -3 dBm • +5 dBm to -7 dBm • -4 dBm to -16 dBm • -12 dBm to -26 dBm • -24 dBm to -35 dBm Default value is <i>Auto</i> .
High limit	Set the average high power limit for the BLE TX output power pass/fail test criteria.
Low limit	Set the average low power limit for the BLE TX output power pass/fail test criteria.
Peak average	Set the peak-to-average power limit for the BLE TX output power pass/fail test criteria.

BLE Tester - Frequency Offset

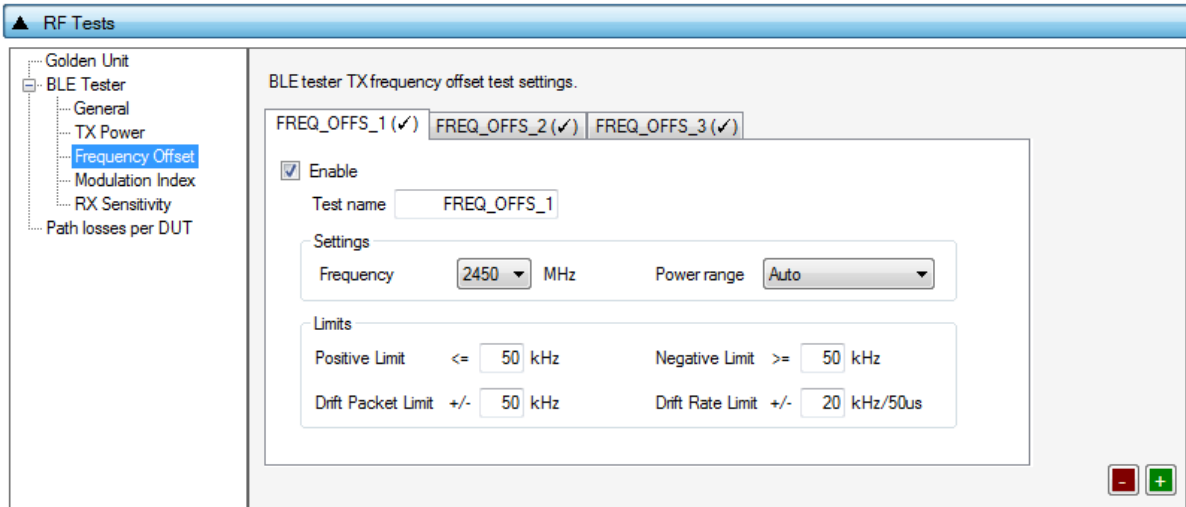

Figure 89: BLE Tester Frequency Offset - DA1468x

Table 82 describes the available options for the *Frequency Offset* test using a BLE Tester instrument.

Table 82: BLE Tester Frequency Offset - DA1468x

Option	Description
Enable	This option enables the specific TX frequency offset test using a BLE tester instrument.
Test name	The name assigned to each test. The assigned name will be shown on the tab and next to it an indication showing whether the specific test is enabled or not.
Frequency	The BLE channel frequency used in the BLE TX frequency offset test.
Power range	Set the device TX output power range. Available options are: <ul style="list-style-type: none"> • Auto • +22 dBm to +7 dBm • +9 dBm to -3 dBm • +5 dBm to -7 dBm • -4 dBm to -16 dBm • -12 dBm to -26 dBm • -24 dBm to -35 dBm Default value is <i>Auto</i> .
Positive limit	Set the maximum positive offset limit in kHz for the TX carrier frequency offset pass/fail test criteria.
Negative limit	Set the maximum negative offset limit in kHz for the TX carrier frequency offset pass/fail test criteria.
Drift packet limit	Set the overall packet drift in kHz for the TX drift pass/fail test criteria.
Drift rate limit	Set the drift rate limit in kHz/50 μs for the TX drift pass/fail test criteria.

DA1458x/DA1468x Production Line Tool

BLE Tester - Modulation Index

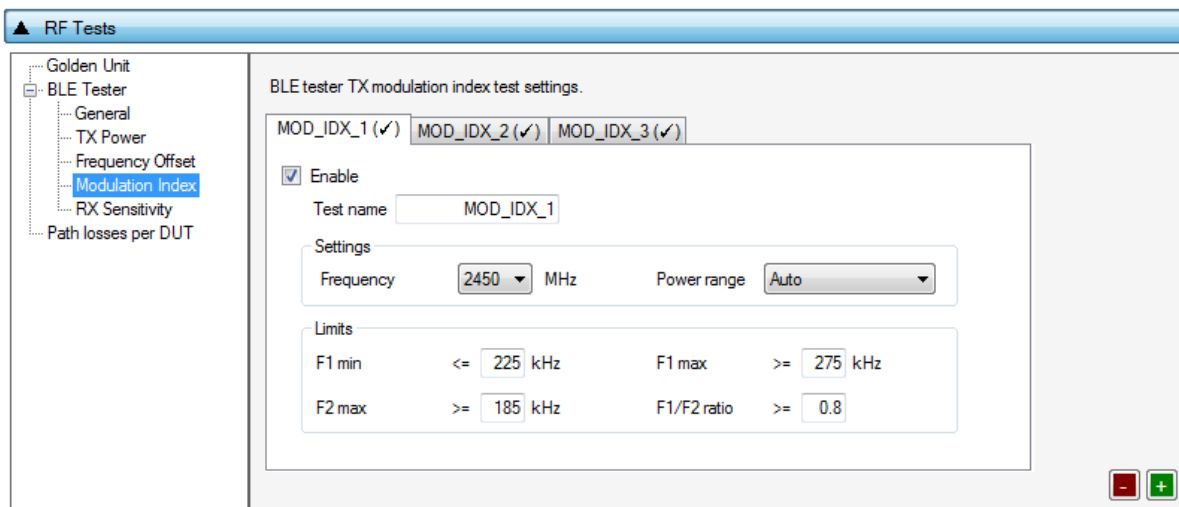

Figure 90: BLE Tester Modulation Index - DA1468x

Table 83 describes the available options for the *Modulation Index* test using a BLE Tester instrument.

Table 83: BLE Tester Modulation Index - DA1468x

Option	Description
Enable	This option enables the specific TX modulation index test using a BLE tester instrument.
Test name	The name assigned to each test. The assigned name will be shown on the tab and next to it an indication showing whether the specific test is enabled or not.
Frequency	The BLE channel frequency used in the BLE TX modulation index offset test.
Power range	Set the device TX output power range. Available options are: <ul style="list-style-type: none"> • Auto • +22 dBm to +7 dBm • +9 dBm to -3 dBm • +5 dBm to -7 dBm • -4 dBm to -16 dBm • -12 dBm to -26 dBm • -24 dBm to -35 dBm Default value is <i>Auto</i> .
F1 min	Set the F1 minimum average limit in kHz for the TX modulation index pass/fail test criteria.
F1 max	Set the F1 maximum average limit in kHz for the TX modulation index pass/fail test criteria.
F2 max	Set the F2 maximum limit in kHz for the TX modulation index pass/fail test criteria.
F1/F2 ratio	Set the F1/F2 maximum average ratio limit for the TX modulation index pass/fail test criteria.

BLE Tester - RX Sensitivity

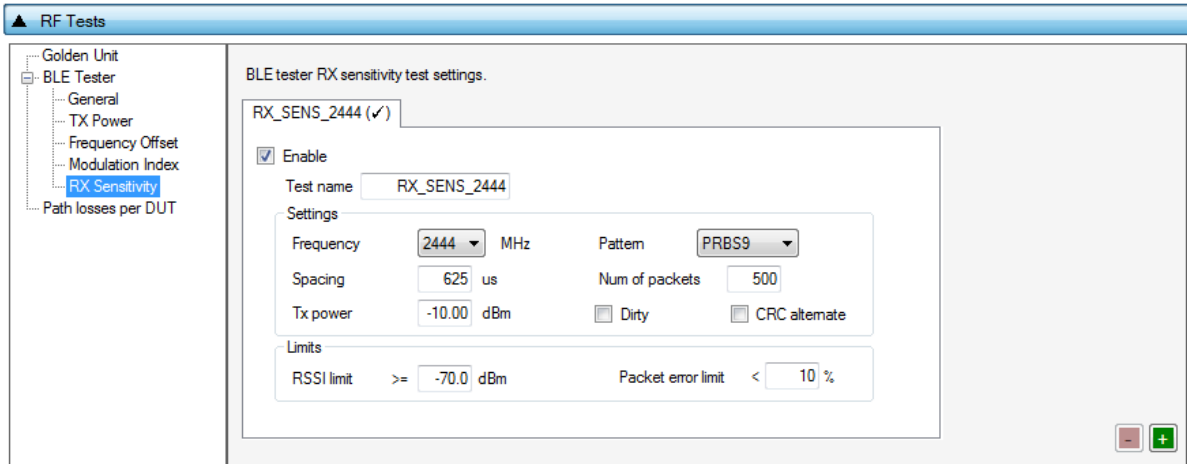

Figure 91: BLE Tester RX Sensitivity - DA1468x

Table 84 describes the available options for the *RX Sensitivity* test using a BLE Tester instrument.

Table 84: BLE Tester RX Sensitivity - DA1468x

Option	Description
Enable	This option enables the specific RX sensitivity test using a BLE tester instrument.
Test name	The name assigned to each test. The assigned name will be shown on the tab and next to it an indication showing whether the specific test is enabled or not.
Frequency	The BLE channel frequency used in the BLE RX sensitivity test.
Pattern	The bit pattern of the TX data. Available options are: <ul style="list-style-type: none"> • PRBS9 • 10101010 • 11110000
Spacing	The packet spacing in μ s.
Num of packets	The number of packets the BLE tester instrument to transmit.
Tx power	The TX output power of the BLE tester instrument. Suggested values are 0 to -10 dBm.
Dirty	When enabled, the BLE tester packet generator can use a dirty table to transmit.
CRC alternate	When enabled, the BLE tester will alternately send packets with CRC correct and CRC incorrect.
RSSI limit	The RSSI limit for pass/fail criteria in the RF RX sensitivity test. If the average RSSI of the device after it has received the transmitted packets is less than this value, the test will be considered as failed.
Packet error limit	This configures the PER limit for pass/fail criteria. If the percentage of the correct packets received is less than the value entered here, the test will fail.

Path Losses per DUT

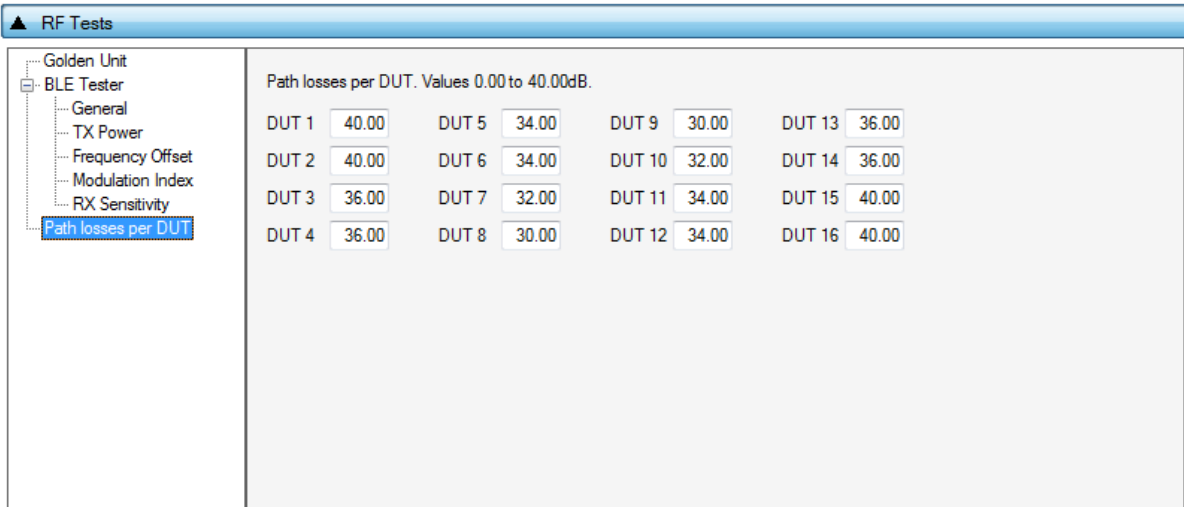

Figure 92: Path Losses per DUT - DA1468x

Table 85 describes the available options for the *Path losses per DUT*.

Based on the relative position of each DUT during RF tests and since the RF tests are performed over the air, values can be used to correct for any path losses. These values are added to the limits of the TX Power and RF RX RSSI tests. Additional information can be found in [Appendix D](#) and [Appendix E](#).

Table 85: Path Losses per DUT from RF Tests DA1468x Options

Option	Description
DUT1-16	Set the path loss value for each DUT. These will be added as corrections to the limits of the TX Power and RF RX RSSI tests

7.2.10.5 GPIO/LED Test

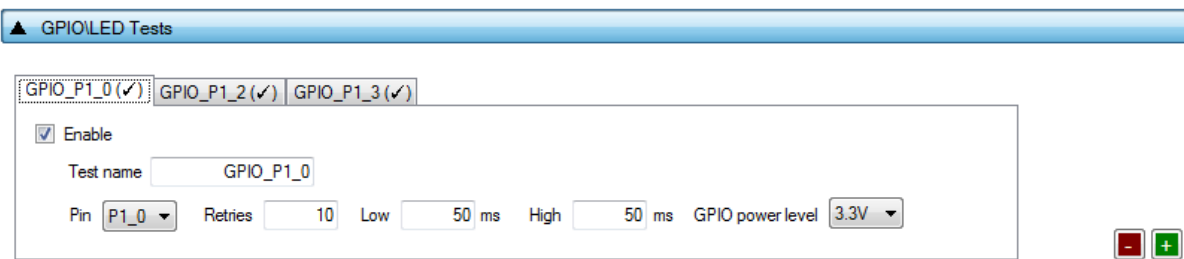

Figure 93: GPIO/LED Tests - DA1468x

GPIO/LED Tests can have multiple instances with different settings. Tests can be added or removed using the two buttons (e.g. and in [Figure 93](#)) at the bottom right side of each panel.

Note: When adding or removing a test, all settings are refreshed with the values written to the XML file, meaning that any unsaved settings will be lost.

Table 86 describes the available options for the *GPIO/LED Tests* DA1468x Options.

In these tests, a specific pulse can be given to a GPIO and any LED connected to it can be visually tested. The *Pin* option sets the GPIO to be used, *Low* and *High* define the duty cycle and the *Retries* the number of pulses.

DA1458x/DA1468x Production Line Tool

Table 86: GPIO/LED Tests - DA1468x

Option	Description
Enable	This option enables the GPIO/LED toggling. Can be used for visual LED testing.
Test name	The name assigned to each test. The assigned name will be shown on the tab and next to it an indication showing whether the specific test is enabled or not.
Pin	The GPIO that will be used for the specific test.
Retries	Number of pulses to be generated for the specific test.
Low	Sets the amount of the OFF time of the pulse in ms for the specific test.
High	Sets the amount of the ON time of the pulse in ms for the specific test.
GPIO power level	Sets the power level of the GPIOs.

7.2.10.6 GPIO Connection Test



Figure 94: GPIO Connection Tests - DA1468x

GPIO Connection Tests can have multiple instances with different settings. Tests can be added or removed using the two buttons (e.g. and in Figure 94) at the bottom right side of each panel.

Note: When adding or removing a test, all settings are refreshed with the values written to the XML file, meaning that any unsaved settings will be lost.

Table 87 describes the available options for the GPIO Connection Tests DA1468x Options.

In these tests, a specific pulse can be given to a GPIO and any LED connected to it can be visually tested. The Pin option sets the GPIO to be used, Low and High define the duty cycle and the Retries the number of pulses.

Table 87: GPIO Connection Tests - DA1468x

Option	Description
Enable	This option enables the GPIO/LED toggling. Can be used for visual LED testing.
Test name	The name assigned to each test. The assigned name will be shown on the tab and next to it an indication showing whether the specific test is enabled or not.
Enable Set Pin	Enables the use of the secondary GPIO to drive the GPIO under test. When this option is set, the Get Pin level option will be disabled.
Set Pin	The GPIO that will be used for the specific test.
GPIO power level	Sets the power level of the GPIOs.
Get Pin	Sets the GPIO to be tested.
Get Pin level	Sets the GPIO state the test awaits to see in the Get Pin. This option will be disabled if the Set Pin mode is enabled.

7.2.10.7 Sensor Test

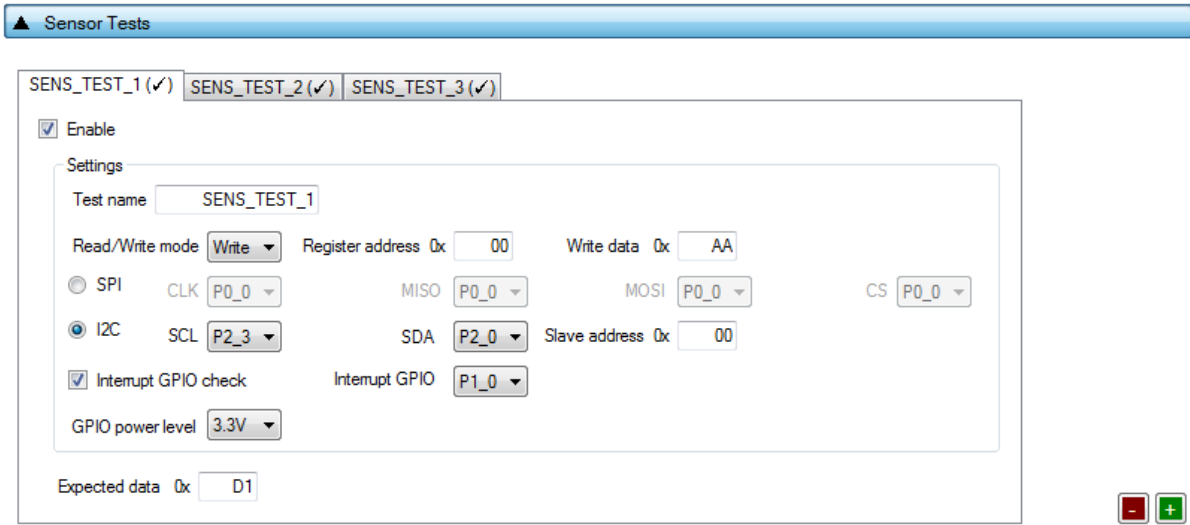

Figure 95: Sensor Test - DA1468x

Sensor Tests can have multiple instances with different settings. Tests can be added and removed using the two buttons (e.g. and) in Figure 95) at the bottom right side of each panel.

Note: When adding or removing a test all settings are refreshed with the values written to the XML file, meaning that any unsaved settings will be lost.

Table 88 describes the available options for the Sensor Tests DA1468x Options.

Table 88: Sensor Tests - DA1468x

Option	Description
Enable	This option enables the specific sensor test.
Test name	The name assigned to each test. The assigned name will be shown on the tab and next to it an indication showing whether the specific test is enabled or not.
Read / Write mode	Select the sensor test procedure, to read or write.
Register address	The sensors register address to read or write data.
Write data	The byte to be written at the sensor register.
SPI / I2C	Select the interface that the sensor is connected to.
SPI - CLK	Select the GPIO for the sensor SPI CLK.
SPI - MISO	Select the GPIO for the sensor SPI MISO.
SPI - MOSI	Select the GPIO for the sensor SPI MOSI.
SPI - CS	Select the GPIO for the sensor SPI CS.
I2C - SCL	Select the GPIO for the sensor I2C SCL.
I2C - SDA	Select the GPIO for the sensor I2C SDA.
Slave address	The sensor I2C bus slave address.
Interrupt GPIO check	Enables the sensor interrupt signal test via GPIO.
Interrupt GPIO	Select the GPIO to be used as a sensor interrupt.
GPIO power level	Sets the power level of the GPIOs.
Expected data	The received sensor byte that will be expected on a successful operation.

DA1458x/DA1468x Production Line Tool

7.2.10.8 ADC Calibration (DA14681-00 only)

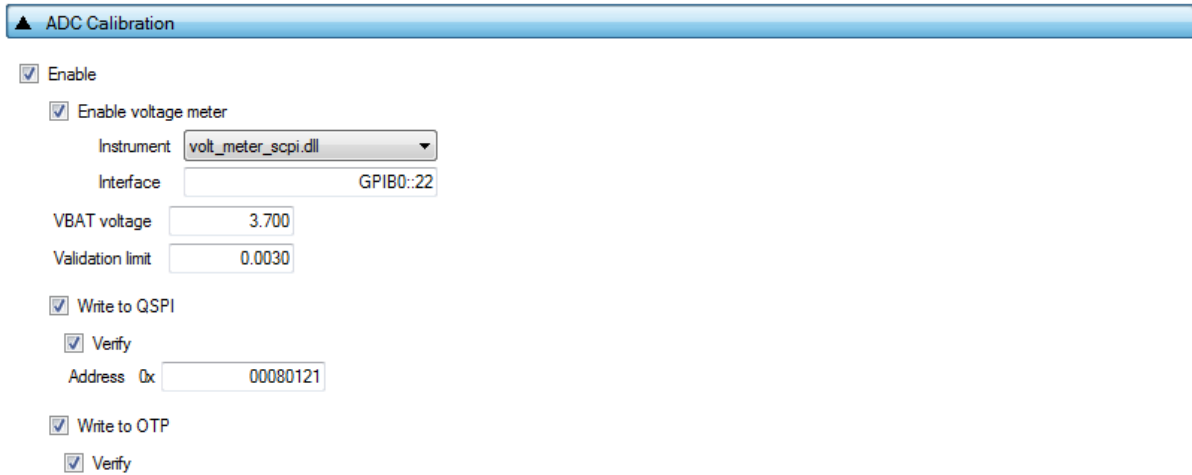

Figure 96: ADC Calibration - DA14681-00

Table 89 describes the available options for the *ADC Calibration* operation available and necessary only for DA14681-00 based devices.

Table 89: ADC Calibration - DA14681-00

Option	Description
Enable	Enable the ADC calibration procedure for DA14681-00 devices.
Enable voltage meter	Enable the use of a voltage meter instrument in the ADC calibration procedure.
Instrument	Select the voltage meter instrument DLL. Names are shown only if a voltage measurement instrument DLL exists in the project folder <code>volt_meter_instr_plugins</code> .
Interface	The interface of the instrument to be used by the driver.
VBAT Voltage	Set the external VBAT value in volts.
Validation limit	After the ADC calibration procedure finishes, a validation procedure will be performed to verify the result. This value indicates the validation limit in volts.
Write to QSPI	Enable the writing of the ADC calibration value to QSPI Flash.
Write to QSPI - Verify	Verify the writing of the ADC calibration value to QSPI Flash.
Address	The QSPI Flash address where the ADC calibration value will be burned.
Write to OTP	Enable the writing of the ADC calibration value to OTP.
Write to OTP - Verify	Verify the writing of the ADC calibration value to OTP.

7.2.10.9 Custom Test

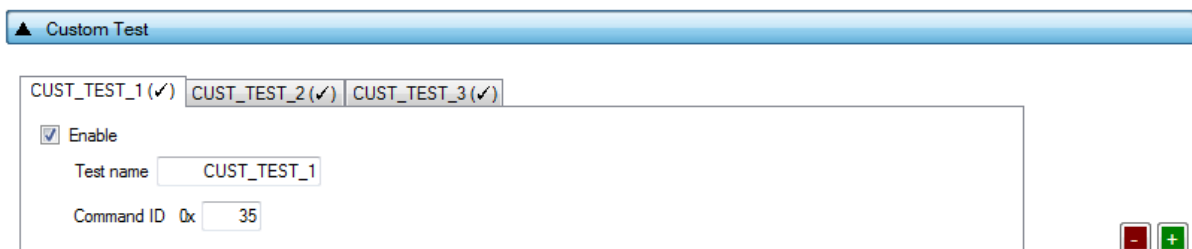



Figure 97: Custom Test - DA1468x

DA1458x/DA1468x Production Line Tool

Custom tests can have multiple instances with different settings. Tests can be added and removed using the two buttons (e.g.  and  in Figure 97) at the bottom right side of each panel.

Note: When adding or removing a test all settings are refreshed with the values written to the XML file, meaning that any unsaved settings will be lost.

Table 90 describes the available options for the DA1468x Custom Tests.

When enabled, the PLT software will send an HCI command through UART to activate a customer-defined test that will run on the DUTs. The HCI custom test command will contain a single byte as data (the *Command ID* byte), to be used mainly as identification for a specific test in the firmware. Default functionality of the production test firmware is to respond with the same *Command ID*. Otherwise, the test will be considered as failed.

Table 90: Custom Tests DA1468x Options

Option	Description
Enable	This option enables the specific custom test.
Test name	The name assigned to each test. The assigned name will be shown on the tab and next to it an indication showing whether the specific test is enabled or not.
Command ID	The byte that will be sent to the device running the production test firmware.

7.2.10.10 External 32kHz Test



Figure 98: External 32kHz Test - DA1468x

Table 91 describes the available options for the DA1468x External 32kHz Tests.

Table 91: External 32kHz Tests DA1468x Options

Option	Description
Enable	This option enables the external 32kHz low power clock test.

DA1458x/DA1468x Production Line Tool

7.2.10.11 Current Measurement Test

▲ Current Measurement Test

Current measurement general settings.

Enable

Settings

Instrument ammeter_scpi.dll

Interface GPIB0::16

Peripheral Current Measurement

Periph Test 1 (✓)

Enable

Test name

Ammeter Setup

Settings

Shunt resistor 0.00 Ohms Wait time 2000 mSecs

Range 0.001 Amps Resolution 0.0001 Amps

Samples 10 SCPI cmd CURR:DC:NPLC 1

Limits per device

Upper limit <= 0.00 Amps Total limit value of 1 DUTs is 0.

Low limit >= 0.00 Amps Total limit value of 1 DUTs is 0.

Test Options

GPIO

GPIO Pin PD_0 GPIO state High GPIO power level 3.3V

PWM frequency 0 KHz PWM duty 0 %

Custom Test

Custom test

Start Command ID 0x 00 Stop Command ID 0x 00

Sleep Current Measurement

Enable

Settings

Sleep mode Extended Deep

Shunt resistor 0.00 Ohms Wait time 2000 mSecs Sleep time 5 Secs

Range 0.001 Amps Resolution 0.000001 Amps

Samples 100 SCPI cmd CURR:DC:NPLC 1

Limits

Upper limit <= 0.000012 Amps Total limit value of 1 DUTs is 1.2E-05.

Low limit >= 0.000017 Amps Total limit value of 1 DUTs is 1.7E-05.

Figure 99: Current Measurement Tests - DA1468x

In this test, an external ammeter instrument can be used to calculate the total current consumption of all the active DUTs. The ammeter instrument can be connected in the blue banana plugs as described in [Current Measurements](#) or to an external power supply (if present) depending the selected [VBAT/Reset Mode](#).



During measurement, PLT will control the instrument using the `ammeter_driver` DLL [1]. [Table 92](#) describes the instrument selection settings found by the `ammeter_driver` DLL, [Table 93](#) describes

DA1458x/DA1468x Production Line Tool

the settings used for each of the peripheral current measurement tests and [Table 94](#) describes the current measurement options for each sleep state.

Note: Modifications in the production test firmware are mandatory in order to achieve the correct current consumption of a specific hardware design (IC and peripherals) for each sleep state. Running the default firmware without any modifications for the hardware design may cause increased current consumption.

Note: During sleep current measurement test, if the measurement taken is outside of the limits set, PTL will reset all devices and begin a firmware download and current measurement to each device separately, using the limits set for a single device, in order to identify which device failed.

Peripheral Current Measurement Tests can have multiple instances with different settings. Tests can be added and removed using the two buttons (e.g.  and  in [Figure 99](#)) at the bottom right side of each panel.

Note: When adding or removing a test all settings are refreshed with the values written to the XML file, meaning that any unsaved settings will be lost.

Table 92: Current Measurement Tests - DA1468x

Option	Description
Enable	This option enables all of Current Measurement tests, which include: <ul style="list-style-type: none"> Peripheral current measurements Extended sleep current measurement Deep sleep current measurement Only one of the Extended/Deep sleep current measurements can be selected, meaning that the other one will be disabled.
Instrument	Select the Ammeter instrument DLL name. Names are shown only if an ammeter instrument DLL exists in the project <code>ammeter_instr_plugins</code> folder.
Interface	The interface of the instrument to be used by the driver.

Table 93: Current Measurement Test – Peripheral Current Measurement - DA1468x

Option	Description
Enable	This option enables the specific peripheral current measurement test.
Test name	The name assigned to each test. The assigned name will be shown on the tab and next to it an indication showing whether the specific test is enabled or not.
Shunt resistor	The value of the shunt resistor used for peripheral measurement. Applicable only if a voltmeter or a NI-DAQ is used to measure current instead of a DMM. Values from 0 to 9999 are supported.
Wait time	The time in ms the PLT will wait before taking a current measurement, after it has sent an instruction to the DUTs to go into a specific sleep state. Supported values are 1 to 500000ms.
Range	The range value in Ampere units that the ammeter instrument will operate. Supported values are 0 to 9999 and default value is 0.001A. When the <code>ammeter_scpi.dll</code> is used, if this value is set to zero, the instrument will use the automatic range functionality.
Resolution	The ammeter instrument resolution value in Ampere units.
Samples	The number of samples that the ammeter instrument will read and average. 1 to 1000 is supported.
SCPI cmd	An SCPI command to be passed to the ammeter instrument just before the measurement is taken. Supports multiple commands separated with a column. Up to 256 characters are supported.

DA1458x/DA1468x Production Line Tool

Option	Description	
Upper limit	<p>The upper limit value for the peripheral current measurement test procedure, for a single DUT.</p> <p>Next to this input field the total upper limit current consumption for all the enabled DUTs is shown, which is the value to be used during testing.</p> <p>Note: During testing, some DUTs may fail until the current measurement test takes place. In that case, the PLT will automatically re-calculate the total upper limit by using the value given for a single DUT multiplied with the number of the active DUTs at the time that the test will run.</p>	
Low limit	<p>The low limit value for the peripheral current measurement test, for a single DUT.</p> <p>Next to this input field the total upper limit current consumption for all the enabled DUTs is shown, which is the value to be used during testing.</p> <p>Note: During testing, some DUTs may fail until the current measurement test takes place. In that case, the PLT will automatically re-calculate the total low limit by using the value given for a single DUT multiplied with the number of the active DUTs at the time that the test will run.</p>	
Test Options	<p>Select between a PWM GPIO test and custom test.</p> <p>Note: For the custom tests to work, a modified production test firmware must be created with tests that set the DUTs to specific states before the current measurement test. Each test must be assigned to a specific opcode. The custom tests are the exact same as in Custom Test.</p>	
Test Options - GPIO	Pin	Sets the GPIO to toggle with the PWM pulse.
	GPIO state	Sets the active state of the GPIO.
	GPIO power level	Sets the power level of the GPIOs.
	PWM frequency	Sets the PWM frequency.
	PWM duty	Sets the PWM duty cycle.
Test Options – Custom Test	Start Command ID	The opcode of the custom test that sets the state of the DUT.
	Stop Command ID	The opcode of the custom test that restores the DUT to its original state.

Table 94: Current Measurement Test - Sleep Current Measurement - DA1468x

Option	Description
Enable	This option enables the specific current measurement using the ammeter instrument provided in the <i>Instrument</i> section.
Shunt resistor	The value of the shunt resistor used for sleep current measurement. Applicable only if a voltmeter or a NI-DAQ is used to measure current instead of a DMM. Values from 0 to 9999 are supported.
Wait time	The time in ms the PLT will wait before taking a current measurement, after it has sent an instruction to the DUTs to go into a specific sleep state. Supported values are 1 to 500000ms.
Sleep time (only for extended sleep)	The time in seconds that the DUTs will remain in extended sleep mode. A timer in the production test firmware will wake up the devices and set them to idle mode. Supported values are 1 to 9sec for DA14580/1/2/3 and up to 1200sec for the rest.
Range	The range value in Ampere units that the ammeter instrument will operate. Supported values are 0 to 9999 and default value is 0.001A. When the <code>ammeter_scpi.dll</code> is used, if this value is set to zero, the instrument will use the automatic range functionality.
Resolution	The ammeter instrument resolution value in Ampere units.
Samples	The number of samples that the ammeter instrument will read and average. 1 to 1000 is supported.

DA1458x/DA1468x Production Line Tool

Option	Description
SCPI cmd	An SCPI command to be passed to the ammeter instrument just before the measurement is taken. Supports multiple commands separated with a column. Up to 256 characters are supported.
Upper limit	The upper limit value for the sleep current measurement test procedure, for a single DUT. Next to this input field the total upper limit current consumption for all the enabled DUTs is shown, which is the value to be used during testing. Note: During testing, some DUTs may fail until the current measurement test takes place; in that case, the PLT will automatically re-calculate the total upper limit by using the value given for a single DUT multiplied with the number of the active DUTs at the time that the test will run.
Low limit	The low limit value for the sleep current measurement test procedure, for a single DUT. Next to this input field the total upper limit current consumption for all the enabled DUTs is shown, which is the value to be used during testing. Note: During testing, some DUTs may fail until the current measurement test takes place; in that case, the PLT will automatically re-calculate the total low limit by using the value given for a single DUT multiplied with the number of the active DUTs at the time that the test will run.

7.2.10.12 Temperature Measurement Test

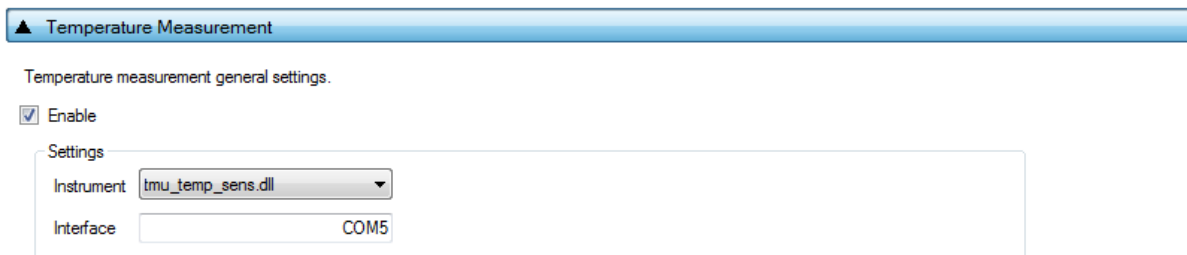

Figure 100: Temperature Measurement Test - DA1468x

Table 95 describes the available options for the DA1468x *Temperature Measurement Test*.

Table 95: Temperature Measurement Test - DA1468x

Option	Description
Enable	This option enables the Temperature measurement test.
Instrument	Select the Temperature measurement DLL. Names are shown only if a Temperature measurement instrument DLL exists in the project folder <code>temp_meas_instr_plugins</code> .
Interface	The interface of the instrument to be used by the driver.

7.2.10.13 Scan Test

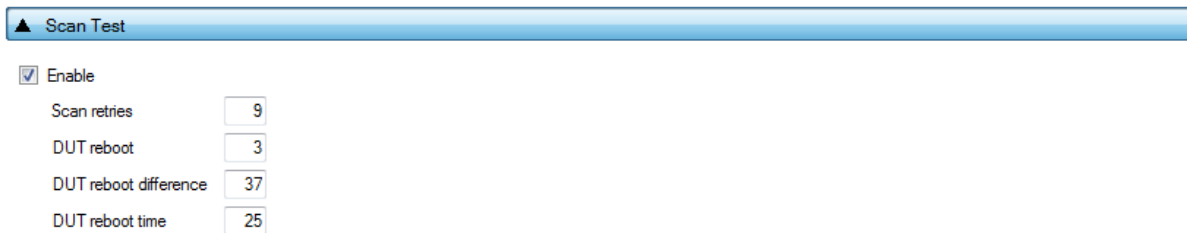

Figure 101: Scan Test - DA1468x

Table 96 describes the available options for the DA1468x *Scan Test*.

DA1458x/DA1468x Production Line Tool

By enabling this test, the Golden Unit will scan for the DUT's BD addresses advertised after the customer firmware has been burned. For this test to work, a bootable firmware with the ability to advertise with the BD address given by the PLT must be burned into each DUT. Additionally, the BD addresses provided by the PLT should be burned into OTP memory or QSPI memory such that the devices advertise with the BD addresses the tool uses.

Table 96: Scan Test DA1468x Options

Option	Description
Enable	This option enables the Scan test.
Scan retries	The total number of BLE advertising scans the Golden Unit will perform.
DUT reboot	Define after how many retries the PLT will reboot the DUTs.
DUT reboot difference	Set the time difference between each DUT when the PLT reboots the devices, in order to avoid air collisions.
DUT reboot time	The time the VBAT will remain low during the device reboot. This value is time in ms*100 (e.g. 15 is 1500ms).

DA1458x/DA1468x Production Line Tool

7.2.11 Memory Functions (DA1468x)

This section describes the Memory Functions settings available when using DA1468x devices. Memory functions include OTP and QSPI Flash memory programming.

7.2.11.1 OTP Memory

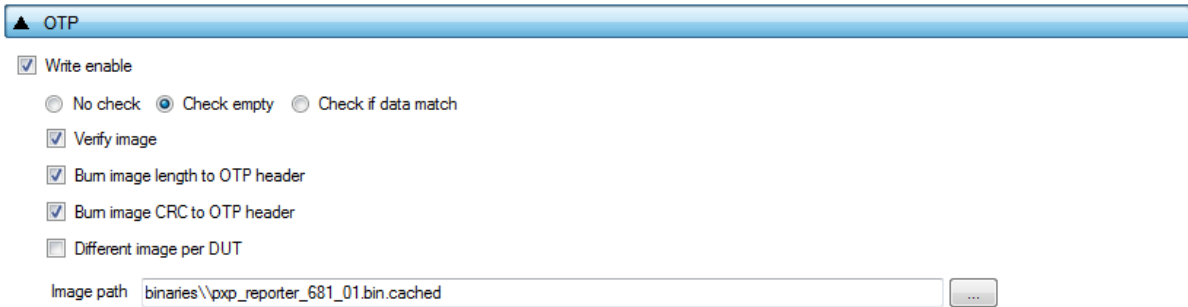

Figure 102: OTP Memory - DA1468x

This test enables the OTP memory programming. Table 97 describes the available options for the *OTP Memory* image write operation.

Note: If the binary is larger than the available OTP image area (OTP memory excluding the header area), the PLT software will split the binary into two parts. The first part will contain only the OTP image area. The second part will contain the OTP header fields, split in OTP words. PLT will burn the non-zero words one by one, as single OTP entries in the OTP header area. The check empty feature will handle the first part as an OTP image binary. The second part will be checked word by word.

Table 97: OTP Memory - DA1468x

Option	Description
Write enable	This option enables the OTP image write operation.
<ul style="list-style-type: none"> ● No check ● Check empty ● Check if data match 	<p>Memory protection options:</p> <p>No check: No protection is enabled. PLT will attempt to burn the OTP memory without running any check.</p> <p>Check empty: PLT will first check if the OTP memory to be burned is empty. If it is empty will burn it.</p> <p>Check if data match: PLT will first check if the memory to be burned is empty. If it is not, it will compare the contents with the data to be burned. If the data are not the same the test will fail without making any changes to the memory. If the data are the same, PLT will not burn the memory to prevent using the OTP repair memory.</p>
Verify image	If this option is enabled, PLT will read back the contents of the OTP memory and compare them to the original image file. If these do not match it will fail.
Burn image length to OTP header	If this option is selected, PLT software will calculate the length in OTP words and burn it to the Memory Header (DA1468x) - OTP Image length. When selected, it will disable the OTP Image length option in Memory header.
Burn image CRC to OTP header	If this option is selected, PLT software will calculate the CRC of the OTP image and burn it to the Memory Header (DA1468x) - OTP Image CRC. When selected, it will disable the OTP Image CRC option in Memory header tab.
Different image per DUT	If this option is selected, a different image per DUT can be burned into the OTP. The image name must be specific for each DUT, as described below.

DA1458x/DA1468x Production Line Tool

Option	Description
Image path	<p>Via this field, the user specifies the image file to be burned into the OTP. A .bin binary file of any name can be selected.</p> <p>Depending on the size of the selected binary, PLT will inform the user if the binary contains both the image and the header part or if it exceeds the maximum supported size.</p> <p>If option <i>Different image per DUT</i> is selected, the user only selects the directory of the images. In that case, the binary file names must have the following format: <code>img_0X.bin</code>, where 'X' denotes the DUT number. For example, if the user has activated DUTs 1, 5 and 10 then <code>img_01.img</code>, <code>img_05.img</code> and <code>img_10.img</code> binary files should exist in the selected OTP image path, as shown in Figure 72.</p>

7.2.11.2 QSPI Flash Memory

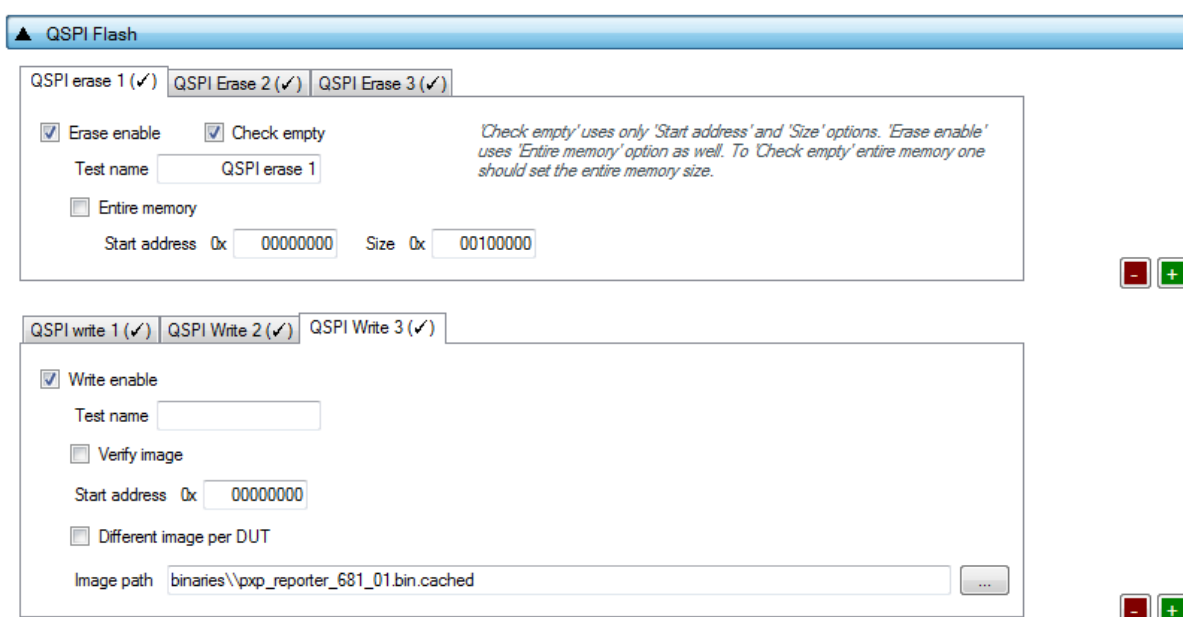

Figure 103: QSPI Flash - DA1468x

This section describes how the QSPI Flash memory can be erased and programmed.

Both erase and write operations can have multiple instances with different settings. Tests can be added and removed using the two buttons (e.g. and in [Figure 103](#)) at the bottom right side of each panel.

Note: When adding or removing a test all settings are refreshed with the values written to the XML file, meaning that any unsaved settings will be lost.

The QSPI flash memory should be erased before any image is written to it. [Table 98](#) describes the available options for the *QSPI Flash Erase* operation.

Table 98: QSPI Flash Erase - DA1468x

Option	Description
Erase enable	This will enable the specific QSPI flash erase test.
Check empty	After QSPI flash erasure, the PLT software can verify the result by sending a specific command to the <code>uartboot_68x.bin</code> firmware running in the DUT. The firmware will read the QSPI flash and check if it is empty. The result will be returned to the PLT software.
Entire memory	This option is only available for the <i>Erase enable</i> option. When this checkbox is selected, the entire memory can be erased. Otherwise, the user can give a start address and a specific number of bytes to be erased.

DA1458x/DA1468x Production Line Tool

Option	Description
Start address	The user can enter a specific start address for the QSPI erasure to start.
Size	The size in bytes to erase, starting from the <i>Start address</i> as explained above.

After every *QSPI Flash erase* test has finished, the *QSPI image write* tests will begin. [Table 99](#) describes the available options for the *QSPI Flash Image Write* operation.

Table 99: QSPI Flash Image Write - DA1468x

Option	Description
Write enable	This will enable the specific QSPI flash image programming test.
Verify image	By selecting this option, the PLT software will read back the contents of the QSPI flash memory and compare them to the original image file. If these do not match, the QSPI memory programming will fail.
Start address	The user can configure the QSPI flash start address where the image will be written.
Different image per DUT	If this option is selected, ten a different image per DUT can be burned into the QSPI flash. The image name must be specific for each DUT, as described below.
Image path	Via this field, the user specifies the image file to be burned into the QSPI flash memory. A <i>.bin</i> binary file of any name can be selected. If option <i>Different image per DUT</i> is selected, the user only specifies the directory of the images. In that case, the binary file names must have the following format: <i>img_0X.bin</i> , where 'X' denotes the DUT number. For example, if the user has activated DUTs 1, 5 and 10 then <i>img_01.img</i> , <i>img_05.img</i> and <i>img_10.img</i> binary files should exist in the selected QSPI image path, as shown in Figure 72 .

7.2.11.3 Memory read



Figure 104: Memory Read Test - DA1468x

Memory Read Tests can have multiple instances with different settings. Tests can be added or removed using the two buttons (e.g. and in [Figure 104](#)) at the bottom right side of each panel.

Note: When adding or removing a test, all settings are refreshed with the values written to the XML file, meaning that any unsaved settings will be lost.

[Table 100](#) describes the memory read test options. With this test, the user can read up to 256 bytes of data from any address from any available memory for the DA1468x devices, such as OTP and QSPI. An example of how the data appears on the log file is shown in [Figure 105](#).

```
Memory read operation initialized. Memory read test name=[QSPI_CUSTOM].
Memory read operation started. Memory read test name=[QSPI_CUSTOM].
Memory read operation ended OK. Test name [QSPI_CUSTOM]. Memory=[QSPI]. Addr=[0xE1000]. Size=[5]. Data=[1122334455].
```

Figure 105: Memory Read Test Example Log File - DA1468x

DA1458x/DA1468x Production Line Tool

Table 100: Memory Read Test - DA1468x

Option	Description
Read enable	This will enable the specific memory reading test.
Test name	The name assigned to each test. The assigned name will be shown on the tab and next to it an indication showing whether the specific test is enabled or not.
Start address	Configures the start address for the read test. OTP valid address is 0x07F80000 – 0x7F8FFFFF.
Size	Number of bytes to read, up to 256 bytes.
Memory type	The type of memory to read the data from. Available options are OTP and QSPI FLASH.

7.2.12 Memory Header (DA1468x)

This section describes the Memory Header programming settings (OTP and QSPI), available in DA1468x devices.

7.2.12.1 OTP Header

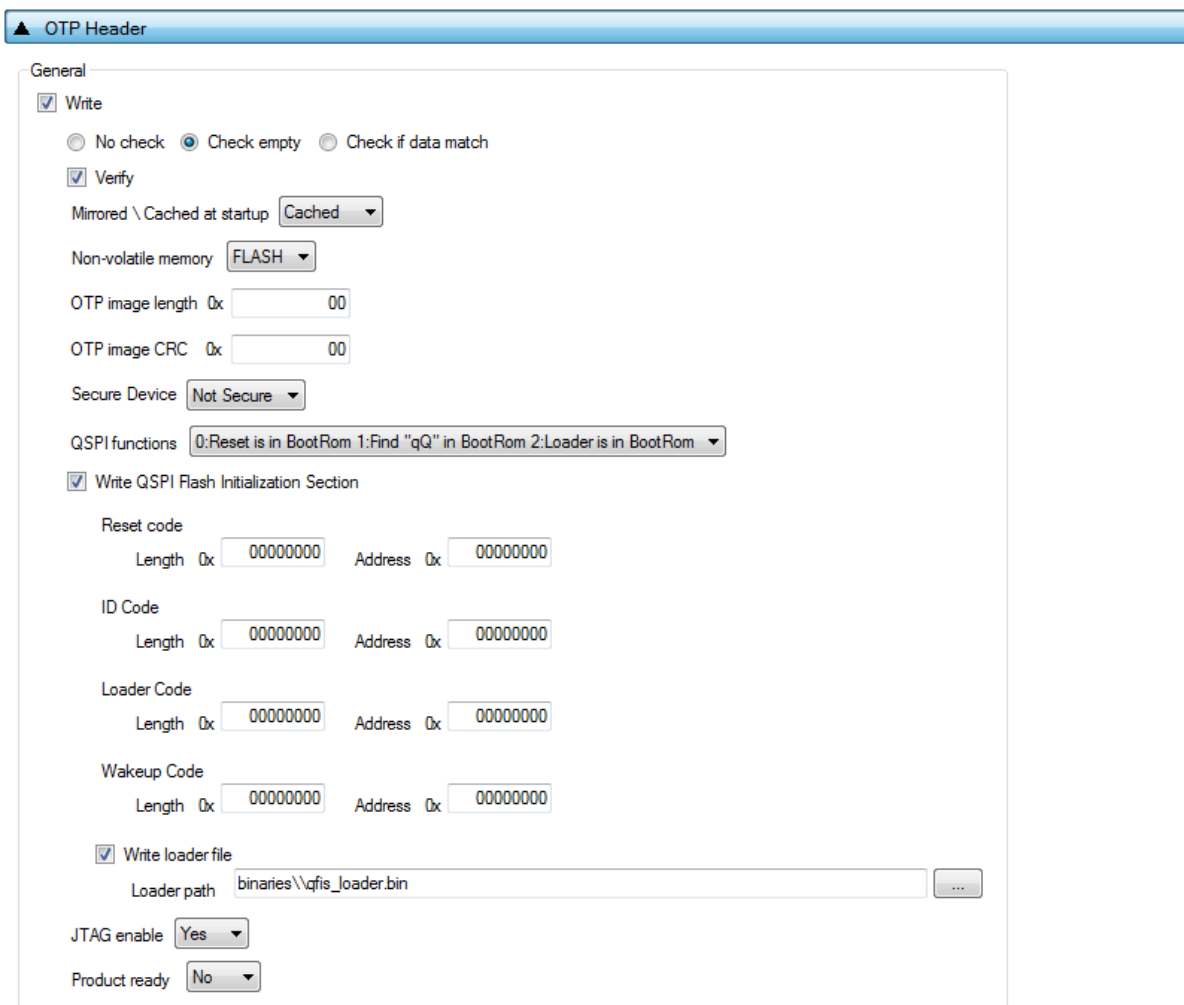

Figure 106: OTP Header - DA1468x

Table 101 describes the available options for the DA1468x *OTP Header* programming.

DA1458x/DA1468x Production Line Tool

Table 101: General - OTP Header DA1468x Options

Option	Description
Write OTP Header	This option enables the OTP header programming.
<ul style="list-style-type: none"> No check Check empty Check if data match 	<p>Memory protection options:</p> <p>No check: No protection is enabled. PLT will attempt to burn the OTP memory without running any check.</p> <p>Check empty: PLT will first check if the OTP memory to be burned is empty. If it is empty will burn it.</p> <p>Check if data match: PLT will first check if the memory to be burned is empty. If it is not, it will compare the contents with the data to be burned. If the data are not the same the test will fail without making any changes to the memory. If the data are the same, PLT will not burn the memory to prevent using the OTP repair memory.</p>
Verify OTP Header	Each value written in the OTP header can be read back and compared with the original ones to verify a successful write.
Mirrored/Cached at startup	<p>Enable OTP cached mode. Available options are:</p> <ul style="list-style-type: none"> Mirrored Cached
Non-volatile memory	<p>Enable OTP NVM mode. Available options are:</p> <ul style="list-style-type: none"> FLASH OTP
OTP image length	<p>The size (in words) for the DMA controller to copy from OTP to system RAM during boot. Should match the OTP image size.</p> <p>Note: This option will be disabled if Burn image length to OTP header option in OTP Memory is enabled.</p>
OTP image CRC	<p>The CRC of the OTP Image burned.</p> <p>Note: This option will be disabled if Burn image CRC to OTP header option in OTP Memory is enabled.</p>
Secure Device (only for DA14682/3)	<p>Enable OTP Secure device mode. Available options are:</p> <ul style="list-style-type: none"> Secure Not Secure
QSPI Functions	<p>Select the QSPI functions. Available options are:</p> <ul style="list-style-type: none"> 0: Reset is in BootRom, 1: Find "qQ" in BootRom, 2: Loader is in BootRom 0: Reset is in OTP, 1: Find "qQ" in BootRom, 2: Loader is in BootRom 0: Reset is in BootRom, 1: Find "qQ" in OTP, 2: Loader is in BootRom 0: Reset is in OTP, 1: Find "qQ" in OTP, 2: Loader is in BootRom 0: Reset is in BootRom, 1: Find "qQ" in BootRom, 2: Loader is in OTP 0: Reset is in OTP, 1: Find "qQ" in BootRom, 2: Loader is in OTP 0: Reset is in BootRom, 1: Find "qQ" in OTP, 2: Loader is in OTP 0: Reset is in OTP, 1: Find "qQ" in OTP, 2: Loader is in OTP
Write QSPI Flash Initialization Section	Enable the QSPI Flash Initialization Section.
Reset Code	The OTP header data for the QSPI reset code.
ID Code	The OTP header data for the QSPI "qQ" identification code.
Loader Code	The OTP header for the QSPI loader code.
Wakeup Code	The OTP header for the QSPI wakeup code.
Write loader file	Enable the writing of the loader file for the QSPI Flash Initialization Section.
Loader path	The file containing the data that will be burned in the QFIS loader.
JTAG enable	Enable the JTAG support.

DA1458x/DA1468x Production Line Tool

Option	Description
Product ready	When this flag is set the device will boot from the NVM selected (OTP or QSPI Flash). Should be used for a production ready device. If enabled, it will not be able to access the device again other than via JTAG, if this option is still enabled in the OTP header.

7.2.12.2 OTP Header - BD Address

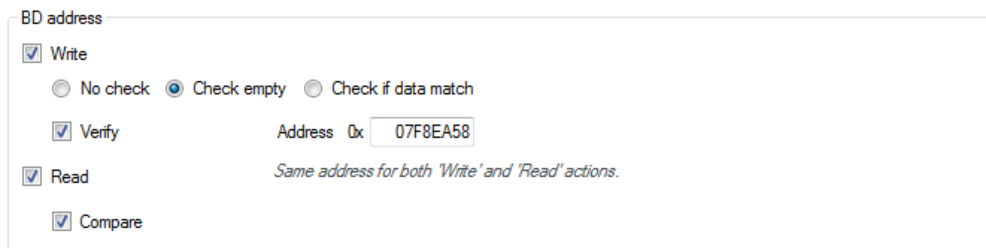

Figure 107: OTP Header BD Address - DA1468x

Table 102 describes the available options for the DA1468x *BD Address* programming.

Table 102: OTP Header BD Address - DA1468x

Option	Description
Write	Enable burning the BD address into the device OTP header.
<ul style="list-style-type: none"> No check Check empty Check if data match 	Memory protection options: No check: No protection is enabled. PLT will attempt to burn the OTP memory without running any check. Check empty: PLT will first check if the OTP memory to be burned is empty. If it is empty will burn it. Check if data match: PLT will first check if the memory to be burned is empty. If it is not, it will compare the contents with the data to be burned. If the data are not the same the test will fail without making any changes to the memory. If the data are the same, PLT will not burn the memory to prevent using the OTP repair memory.
Verify	When enabled, the PLT will read back the BD address burned into the OTP header and compare it to the one provided by the PLT.
Read	This will read the BD address written in the OTP Header field. It does not depend on the previous tests to run, but it is necessary for the following <i>Compare</i> test.
Compare	When the <i>Read</i> option is enabled, a comparison will be performed between the read BD address and the BD address entered in the DUT by the PLT, as described in the BD address DUT assignment method.
Address	The OTP address where the BD address will be written. This field is the same for all of the above actions. Default value is 0x07F8EA58. OTP valid address is 0x07F80000 – 0x7F8FFFF.

7.2.12.3 OTP Header - XTAL Trim

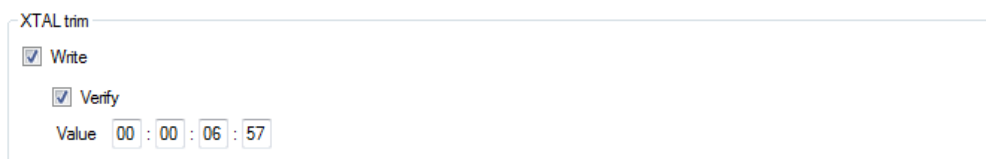

Figure 108: OTP Header XTAL Trim - DA1468x

Table 103 describes the available options for the DA1468x *OTP Header XTAL Trim* programming operation.

DA1458x/DA1468x Production Line Tool

Table 103: OTP Header XTAL Trim - DA1468x

Option	Description
Write	Enable burning the BD address into the device OTP header.
Verify	When enabled, the PLT will read back the BD address burned into the OTP header and compare it to the one provided by the PLT.
Value	Crystal oscillator calibration value common to all devices. Can be burned only if the automatic crystal burn calibration operation for the OTP memory in XTAL Trim is disabled.

7.2.12.4 QSPI Header - BD Address

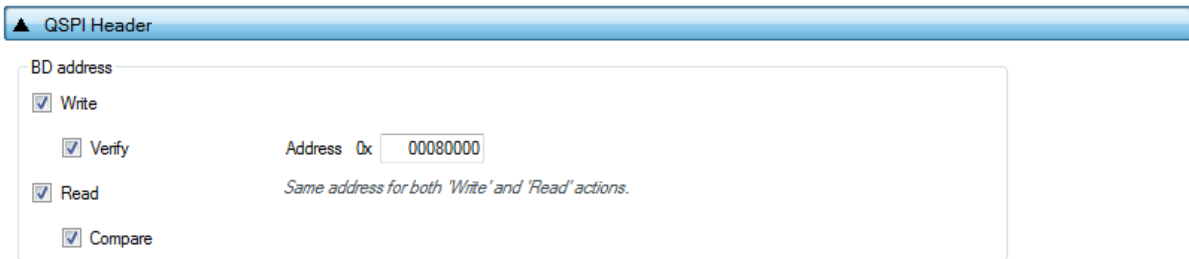

Figure 109: QSPI Header BD Address - DA1468x

Table 104 describes the available options for the DA1468x *BD Address* programming operation into the QSPI Header.

Table 104: QSPI Header BD Address - DA1468x

Option	Description
Write	When selected the BD address will be written in the QSPI Header.
Verify	If selected, the BD address will be read back from the QSPI Header and compared to the original.
Read	This option will read the BD address written in the QSPI Header field. It does not depend on the previous tests to run, but it is necessary for the following <i>Compare</i> test.
Compare	When the <i>Read</i> option is enabled, a comparison will be performed between the read BD address and the BD address entered in the DUT by the PLT, as described in the BD address DUT assignment method.
Address	The QSPI Flash address where the BD address will be written. This field is the same for all of the above actions. Default value is 0x080000.

7.2.12.5 QSPI Header - XTAL Trim

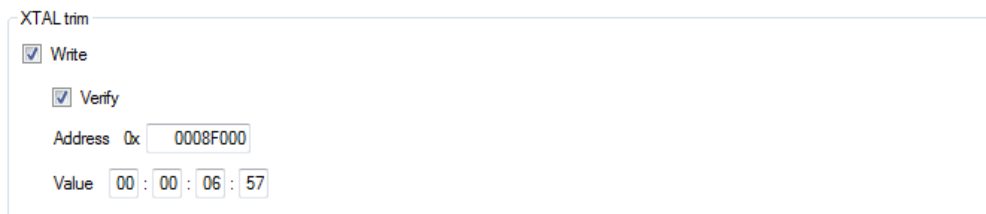

Figure 110: QSPI Header XTAL Trim

Table 105 describes the available options for the *XTAL Trim* programming into the QSPI Header.

Table 105: QSPI Header XTAL Trim

Option	Description
Write	Enable burning a crystal oscillator calibration value, common to all devices.

DA1458x/DA1468x Production Line Tool

Option	Description
Verify	When enabled, the crystal oscillator calibration value will be read back from the QSPI Flash and compared to the one the user has supplied.
Address	The QSPI Flash address where the crystal oscillator calibration value will be burned. Default value is 0x08F000.
Value	Crystal oscillator calibration value common to all devices. Can be burned only if the automatic crystal burn calibration operation for the QSPI memory in XTAL Trim is disabled.

7.2.12.6 Custom Memory Data

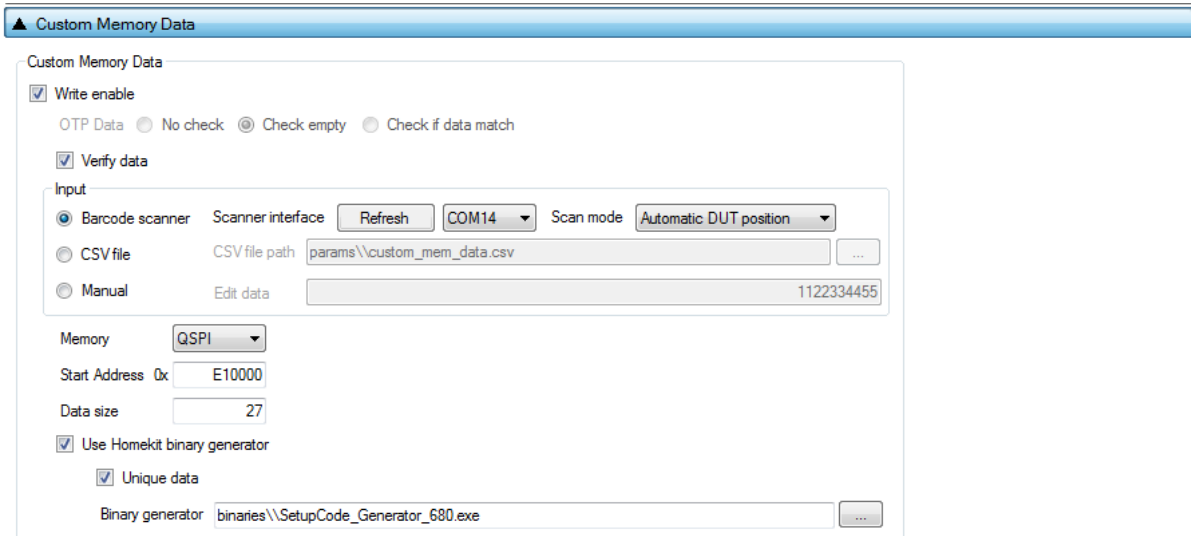

Figure 111: Custom Memory Data - DA1468x

Table 106 describes the *Custom Memory* data test options. With this test, the user can write any data to any address to any available memory for the DA1468x devices, such as OTP, register initialization at OTP-TCS section and QSPI. Data input modes can be a Barcode Scanner, a CSV file or data entered manually. For the DA1468x devices, the data entry can be used as input to the Homekit binary generator to create a binary and automatically write it to a memory.

Table 106: Custom Memory Data - DA1468x

Option	Description
Write enable	This option enables the Custom data programming.
Verify data	When selected, the data written will be read back from the memory and will be compared to the original.
<ul style="list-style-type: none"> No check Check empty Check if data match (Only available when OTP memory, OTP TCS field or CSV file as input is selected)	Memory protection options: No check: No protection is enabled. PLT will attempt to burn the OTP memory without running any check. Check empty: PLT will first check if the OTP memory to be burned is empty. If it is empty will burn it. Check if data match: PLT will first check if the memory to be burned is empty. If it is not, it will compare the contents with the data to be burned. If the data are not the same the test will fail without making any changes to the memory. If the data are the same, PLT will not burn the memory to prevent using the OTP repair memory.
<ul style="list-style-type: none"> Barcode scanner CSV file 	Note: Barcode scanner mode is only available with GUI PLT Application . CLI PLT Application does NOT support this feature. Custom data input options:

DA1458x/DA1468x Production Line Tool

Option	Description	
<ul style="list-style-type: none"> Manual data 	Scanner interface (Barcode scanner)	<p>Selection of the Barcode scanner input. Both HID and COM port interfaces are supported. This list provides an HID and all available COM ports as selectable options.</p> <p>Any HID device is supported that includes newline (CR-LF) characters at the end of the scanned data.</p> <p>For the COM port interface, a common USB to UART barcode scanner is supported. PLT has been tested with Honeywell Xenon 1900. Appendix L describes the setup procedure.</p> <p>This option is the exact same option as in Scan Mode and the DA1468x devices in Custom Memory Data.</p>
	Scan mode (Barcode scanner)	<p>Scan DUT position: In this mode, the users must first scan the DUT position number and then the BD address. The string used for the position of each DUT is "TEST POSITION 0xx" where "xx" is the DUT position number.</p> <p>Automatic DUT position: Scanned BD address will be assigned to the selected DUT. The DUT selection is automatically been made, starting from the first active DUT and selecting the next one after a successful BD address scan. Users can change the selected DUT using the controls on the GUI PLT screen shown in Figure 117.</p> <p>This option is the exact same option as in Scan Mode and the DA1458x devices in Custom Memory Data.</p>
	CSV file path (CSV file)	Path to the CSV file containing data for each device discriminated using BD addresses. The CSV file format is described in Custom data CSV file format .
	Edit data (Manual data)	Hexadecimal data input of up to 256 bytes to burn. These data will be burned to all active DUTs.
Memory (available with Barcode scanner and Manual data modes)	<p>Memory type selection to burn the data. Available options are OTP, QSPI and OTP TCS (only with Manual data).</p> <p>Note: When Manual Data input mode is selected, writing a register in OTP TCS section is also supported. In this mode, the address field changes to register address and the data to register value. PLT will automatically find the TCS slot to burn the value, and the mirrored equivalent.</p>	
Start address (available with Barcode scanner and Manual data modes)	Memory address offset to begin burning the data. OTP valid address is 0x07F80000 – 0x7F8FFFFF.	
Data size (available with Barcode scanner and Manual data modes)	<p>The size of the memory data to burn. In barcode scanner, the size is the number of scanned characters. In manual data, the size is number of bytes.</p> <p>Note: If the Homekit binary generator is used, the data size entered here is the size of the setup code and serial number as explained in Table 17. In the example the data to be scanned are "5086747870SX03112233445566R", meaning that the data size should be 27 since ASCII character will be scanned. The data size to be actually burned into the devices will be 574 bytes, which is the binary size created by the SetupCode_Generator_680.exe application.</p>	
Use Homekit binary generator (available with Barcode scanner mode)	If enabled the input memory data from the barcode scanner will be applied as input to the Dialog Homekit setup code binary generator. PLT will automatically call the setup code binary generator and burn the files created.	
Unique data (available with Barcode scanner mode)	If enabled the input memory data will be compared to each other and if same data are found an error will be issued. Comparison can only be performed per current PLT test run and not for previous tested devices.	
Binary generator (available with Barcode scanner mode)	The path to the Homekit setup code binary generator executable. PLT will automatically call this application and burn the files created.	

7.2.13 Debug Settings

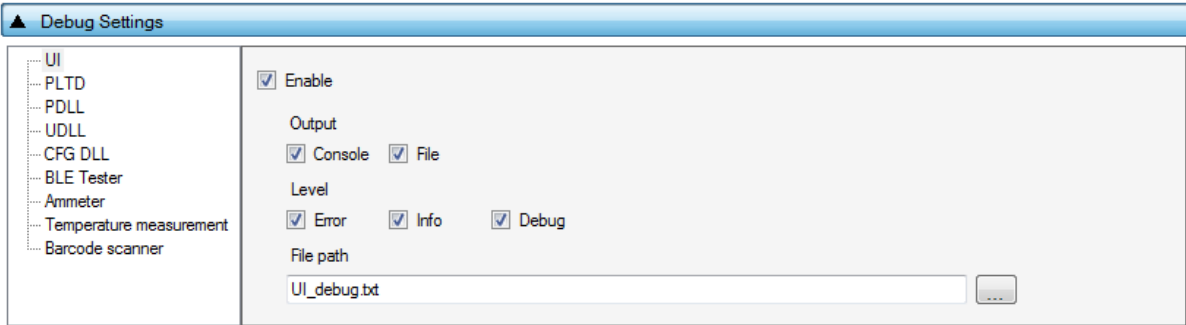

Figure 112: Debug Settings

Table 107 describes the available options for the *Debug Settings*. Debug messages are available in all PLT software blocks shown in Figure 20.

Note: Printing debug information may introduce system delay and thus some tests may fail due to time out expirations. We suggest having debug information disabled in all software blocks and only partially enable when there is a real need for it. From PLT v4.0 and onwards, this system delay has been almost eliminated as debug print messages are printed from a lower priority queue. It is safer, but it is still suggested to have the debug prints disabled.

Table 107: Debug Settings

Option	Description
Enable	Enable debug message prints for the selected library or UI.
Output - Console	Sends the debug messages to the <code>stdio</code> output. The PLT CLI does not support this option. If enabled, debug messages will be redirected to the equivalent files.
Output - File	Save the debug messages to a file.
Level - Error	Enable error debug level messages. All debug print messages marked as error will be printed.
Level - Info	Enable info debug level messages. All debug print messages marked as info will be printed.
Level - Debug	Enable low level debug level messages. All low level debug print messages will be printed.
File path	Select the file that the debug messages will be saved. The file should exist; otherwise, it should be created manually. Used only when the option Output - File is selected.

7.2.14 Security

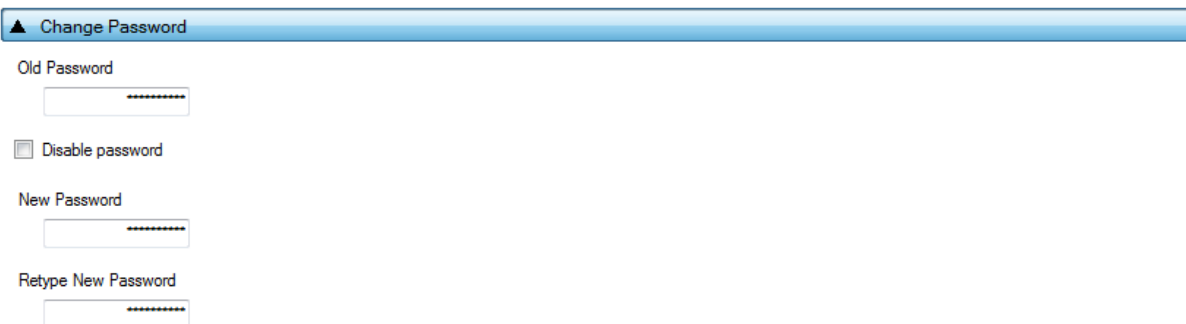

Figure 113: Security

DA1458x/DA1468x Production Line Tool

In this field, a password can be set to protect specific tool actions, such as:

- Opening the CFG PLT or the GUI PLT application.
- Closing the CFG PLT or the GUI PLT application.
- Opening or refreshing configuration settings in the GUI PLT application.
- Opening the settings menu in the GUI PLT application.

[Table 108](#) describes the available options for the *Security Options*.

Table 108: Security Options

Option	Description
Old Password	Type the current password to enable changing of the following fields.
Disable Password	This option will disable the password usage.
New Password	Type a new password.
Retype New Password	Verify the new password.

7.3 GUI PLT Application

The GUI PLT (DA1458x_DA1468x_GUI_PLT.exe) is a Graphical User Interface application that performs the device validation and programming process. At the same time, it allows the users to monitor the entire procedure in detail. The GUI PLT uses the same XML file configured from CFG PLT as described in section 7.2.

Note: If a change is made to the XML file from the CFG PLT, then the GUI PLT settings should be refreshed as described in [Table 109](#).

[Figure 114](#) shows the initial screen of the GUI PLT, which is described in [Table 109](#).

DA1458x/DA1468x Production Line Tool

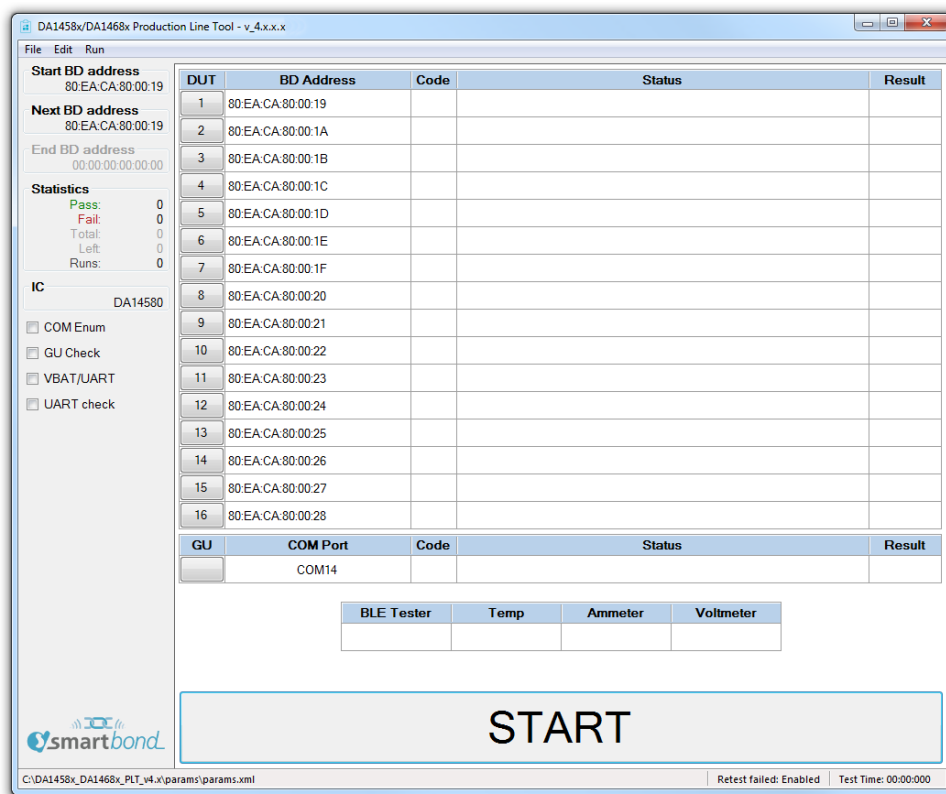

Figure 114: GUI PLT Main Screen

Table 109: GUI PLT Main Screen Description

Options	Description
File options	
File > Open XML file	Opens a new XML file and loads its settings. The full path of the new XML file is shown at the bottom end of the screen.
File > Refresh XML file	Reloads the settings from the XML file and initializes itself with the new settings.
File > Open CSV file	Contains a list with all the available CSV files to open.
File > Exit	Exits the GUI PLT application.
Edit options	
Edit > Settings	Opens the GUI PLT Settings window.
Run options	
Run > Run Configuration PLT	Opens the CFG PLT application.
Left Column options	
Start BD Address	The BD address the PLT session started with, as described in section 7.2.4.
Next BD Address	The BD address that will be used on the BD address assignment for the next run as described in section 7.2.4.
End BD Address	The BD address the PLT session ends with as described in section 7.2.4. This option is available only when <i>Range mode</i> is enabled.
Statistics	This field holds statistics for each PLT session. Table 29 describes the <i>Statistics</i> field.
IC	The selected IC of the PLT.

DA1458x/DA1468x Production Line Tool

Options	Description
COM Enum	If this checkbox is enabled then the START button initiates the automatic Window COM port enumeration for the DUT.
GU Check	If this checkbox is enabled then the START button initiates the automatic Window COM port enumeration for the Golden Unit.
VBAT/UART	If this checkbox is enabled then the START button will enable the VBAT and UART for the DUTs selected under <i>VBAT/UART</i> in Table 110 .
UART check	If this checkbox is enabled then the START button initiates the UART check procedure for the DUTs with a specified Baud rate set from the user through the GUI PLT Settings . During this test, 1000 packets will be sent, received back and checked for errors. For the DA14580/1/2/3 and DA1468x DUTs the packets contain 252 bytes and for the DA14585/6 DUTs 100 bytes of data. Note: Before any UART transfer begins, PLT will download the production test firmware to the active DUTs.
Center screen options	
DUT panel	Shows the following fields for each DUT: <ul style="list-style-type: none"> ● DUT: DUT connector number on the PLT hardware. This field is also a button that opens the Log file for the specific DUT. ● BD Address: BD address assigned to the DUT. ● Code: Real-time status as a PLTD DLL special code described in [1]. ● Description: A brief description of the status code. ● Result: Simplified color-coded status showing the progress per DUT.
GU panel	Shows the following fields for the Golden Unit: <ul style="list-style-type: none"> ● GU: A button that opens the Golden Unit Log file. ● COM Port: The COM port assigned to the Golden Unit. ● Code: Real-time status as a PLTD DLL special code described in [1]. ● Status: A brief description of the status code. ● Result: Simplified color-coded status showing the progress of the GU.
Instrument panel	This field shows a simplified color-coded status is shown for each of the instruments (BLE Tester , Temp , Ammeter and Voltmeter), if they are enabled.
START button	If one of the options <i>COM Enum</i> , <i>GU Check</i> , <i>VBAT/UART</i> or <i>UART check</i> is enabled, then selecting the <i>START</i> button will initiate the chosen test. If no option is selected, selecting the <i>START</i> button initiates the production procedure. Note: To select and press the <i>Start Button</i> press the <i>space-bar</i> key. The <i>Start Button</i> can only be pressed with the mouse (or use the <i>⌘</i> key as a shortcut), after the selected procedure is finished, in order to return to main screen. This is to avoid pressing the <i>Start Button</i> and starting a new test procedure, by mistake.
Bottom of the main screen	
Left panel: C:\Release\params\params.xml	Shows the full path of the XML file that is currently used.
Center panel: Retest failed: Disabled	Shows if the Re-test option in GUI PLT Settings is enabled.
Right panel: Test Time: 00:00:000	This timer starts counting when the START button is pressed and runs until the PLT returns to its idle state, showing the approximate duration of the tests.

DA1458x/DA1468x Production Line Tool

7.3.1 GUI PLT Settings

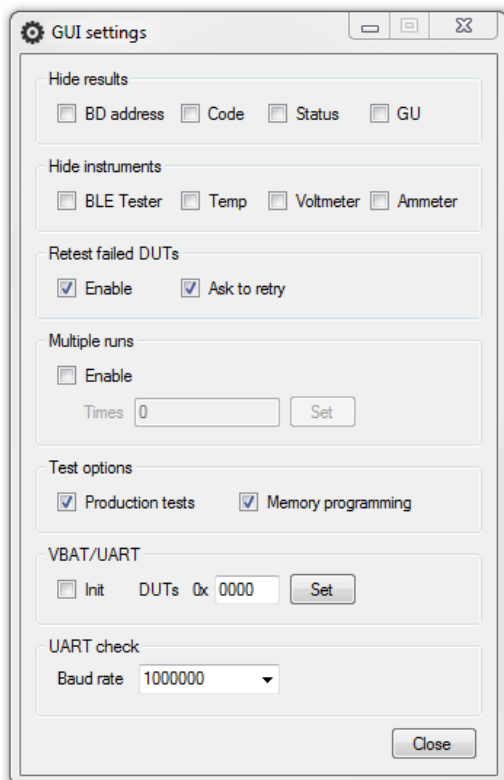

Figure 115: GUI PLT Settings

Figure 115 shows the GUI PLT settings window. In this window, various graphic options and features can be set as described in Table 110.

Table 110: GUI PLT Settings

Field	Option	Description
Hide results	BD address	This option will hide the <i>BD address</i> column in the DUT panel of the GUI PLT.
	Code	This option will hide the <i>Code</i> column in the DUT panel of the GUI PLT.
	Status	This option will hide the <i>Status</i> column in the DUT panel of the GUI PLT.
	GU	This option will hide the <i>GU</i> column in the DUT panel of the GUI PLT.
Hide instruments	BLE Tester	This option will hide the <i>BLE Tester</i> column in the GU panel of the GUI PLT.
	Temp	This option will hide the <i>Temp</i> column in the GU panel of the GUI PLT.
	Voltmeter	This option will hide the <i>Voltmeter</i> column in the GU panel of the GUI PLT.
	Ammeter	This option will hide the <i>Ammeter</i> column in the GU panel of the GUI PLT.
Retest failed DUTs	Enable	If this option is enabled, any DUT that failed during the main procedure will immediately re-run the tests having the exact same options including the <i>BD address</i> assigned to it. This option is the exact same option as <i>Re-test failed DUTs</i> in section 7.2.3.2.
	Ask to retry	This option will show a message asking to do a re-test in case any DUT failed. If this option is disabled, the re-testing will be done automatically.

DA1458x/DA1468x Production Line Tool

Field	Option	Description
Multiple Runs	Enable	By enabling this option, the GUI PLT will perform multiple procedures without any delay between them. This is used for only for evaluation.
	Times	The number of times to run.
Test Options	Production tests	Enables /Disables the production test procedure. This is the same option as <i>Production tests</i> in section 7.2.3.2.
	Memory programming	Enables /Disables the production test procedure. This is the same option as <i>Memory programming</i> in section 7.2.3.2.
VBAT/UART	Init	If this option is enabled, the PLT hardware will be reset before enabling the DUTs. This option is enabled only when <i>VBAT/UART</i> in the main screen is enabled.
	DUTs	Bitwise DUT set/reset for each of the 16 DUTs using a 16-bit hexadecimal value. 089 Example: To enable only DUTs 1, 2, 15 and 16 use "C003" (1100 0000 0000 0011 = 0xC003).
UART check	Baud rate	Sets the Baud rate for the UART check test.

7.3.2 Barcode Scanner Mode

A barcode scanner can be used for two purposes. It can be used to scan DUT BD addresses and/or Custom Memory Data. If any these options have the Barcode scanner option enabled then the Barcode Scan option will appear in the GUI PLT as shown in [Figure 116](#). If both options are enabled then the GUI PLT will first use the Barcode scanner for the BD address [Scan Mode](#) assignment and then for the [Custom Memory Data](#).

In all cases described in section 7.2.4.1 except [Scan Mode](#), the GUI PLT assigns BD addresses right before the PLT starts the production test run. Device BD addresses should be scanned before the start of a production test run. If the *START* button is pressed without any BD address being assigned to the device, the PLT will **not** run the tests.

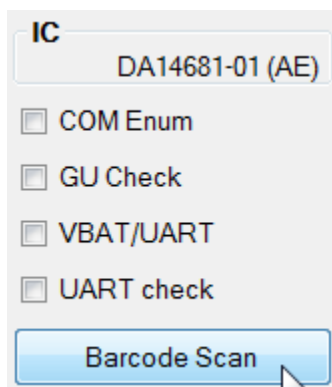

Figure 116: Barcode Scan Option in GUI PLT

Two different device BD address scanning procedures are supported. If the same BD address is used twice an error message appears in the DUT panel. It then waits for a unique BD address. An example is shown in [Figure 118](#).

1. *Scan DUT position.* In this mode, the user must first scan the DUT position and then the BD address. The string used for the position of each DUT is "TEST POSITION 0xx" where "xx" is the DUT number 1 to 16.
2. *Automatic DUT position.* The scanned BD address will be assigned to the selected DUT. DUT selection is done automatically. The PLT starts from the first active DUT and goes to the next after a successful BD address scan. The user can change the selected DUT via the controls shown in [Figure 117](#). If the scanned BD address was successfully assigned, the PLT will automatically select the next active DUT and wait for a new BD address to be scanned.

DA1458x/DA1468x Production Line Tool



Figure 117: Barcode Scanner Controls

If the [Custom Memory Data](#) test requires data to be scanned then the user must scan the Custom data after the BD address for each DUT. [Homekit Setup Code Scan Example](#) provides detailed steps showing how to scan both BD addresses and data for the Custom Memory data test.

After all active DUTs have BD addresses assigned; the user should press the *END* button in the controls to return to the main screen. Pressing the *START* button will then start the test execution.

Note: If the *Barcode Scan* button is pressed again, all BD addresses will be reset and the BD address assignment procedure will begin again.

DUT	BD Address	Code	Status	Result
1	11:22:33:44:55:06		BARCODE SCANNER BD ADDRESS OK	PASS
2	00:00:00:00:00:00		BD ADDRESS 11:22:33:44:55:06 ALREADY USED. RETRY	CHECK
3	11:22:33:44:55:08		BARCODE SCANNER BD ADDRESS OK	PASS
4	11:22:33:44:55:09		BARCODE SCANNER BD ADDRESS OK	PASS
9	11:22:33:44:55:13		BARCODE SCANNER BD ADDRESS OK	PASS
10	00:00:00:00:00:00			
11	00:00:00:00:00:00			
12	00:00:00:00:00:00			

Figure 118: Barcode Scan - BD Address Assignment

7.3.2.1 Homekit Setup Code Scan Example

An example of using the barcode scanner and [Custom Memory Data](#) will be given. A barcode scanner will be used to scan different Homekit setup codes. PLT will call the *SetupCode_Generator_680.exe* application to create the binaries that contains the DUTs serial numbers and the hashed version of the setup codes. Finally, it will program the binaries to the DUTs. The process will be described in [Table 111](#). The example will use DA14681-01 DUTs and configure the PLT such that to perform XTAL trim test, RF test and homekit setup code scanning and programming.

Table 111: Homekit Setup Code Scan Example

#	Action
1	Copy PLT software DA1458x_DA1468x_PLT_v_4.x.x.x under C:\ directory.

DA1458x/DA1468x Production Line Tool

#	Action
2	<p>Open <i>DA1458x_DA1468x_CFG_PLT.exe</i>.</p>
3	<p>Go to <i>Hardware Setup-> Device IC</i> and select <i>DA14681-01 (AE)</i>. Press the <i>Save*</i> button.</p>
4	<p>Go to <i>Hardware Setup-> Active DUTs</i> and select <i>DUT13, DUT14, DUT15</i> and <i>DUT16</i>. Press the <i>Save*</i> button.</p>
5	<p>Go to <i>Hardware Setup-> Golden Unit COM Port</i> and auto-detect the COM port. Press the <i>Auto</i> button. Press the <i>Save*</i> button.</p>
6	<p>Go to <i>Test Settings->XTAL Trim</i> and enable the settings as shown in the following picture. Press the <i>Save*</i> button.</p> <p>These settings will enable the XTAL trim calibration test. The result of the XTAL trim calibration will be saved into QSPI flash. Dialog SDK firmware is able to read the value from this specific QSPI address (0x8F000) and apply it to the appropriate chipset XTAL trim register.</p>

DA1458x/DA1468x Production Line Tool

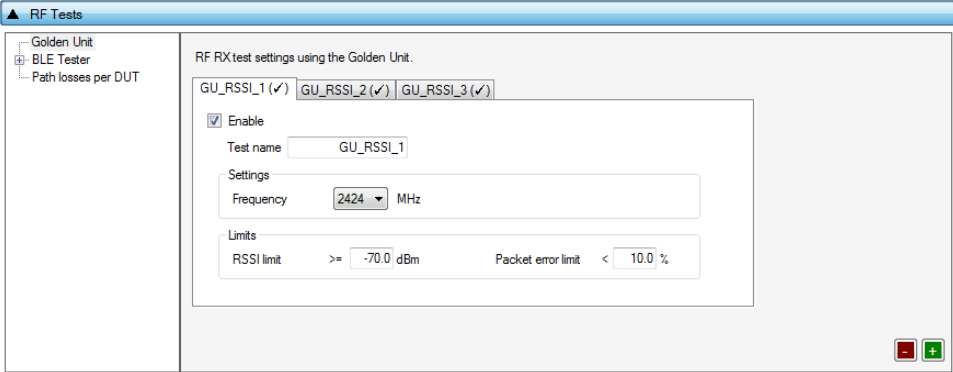
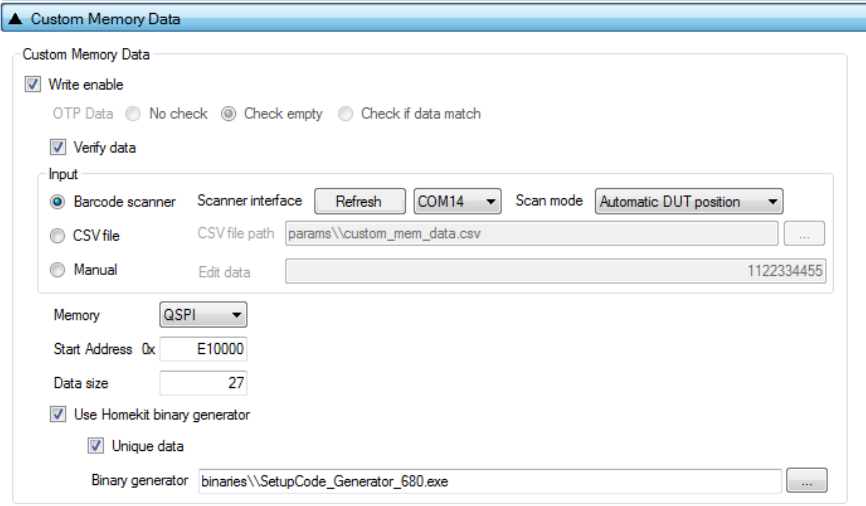
#	Action
7	<p>Go to <i>Test Settings</i>-><i>RF Tests</i> and enable the settings shown in the following picture. Three RF tests at channels 2424MHz, 2450MHz and 2476MHz are already enabled in the PLT by default. Check that all settings are correct. Press the <i>Save*</i> button.</p> 
8	<p>Deselect everything in <i>Memory Functions</i> tab. No need to burn any image for this example. Press the <i>Save*</i> button.</p>
9	<p>Connect to the PC a USB to Serial (COM) barcode scanner instrument. Keep the Windows COM port assigned to the instrument.</p>
10	<p>Go to <i>Memory Header</i>-><i>Custom Memory Data</i> and enable the settings shown in the following picture. Change the <i>Scanner Interface</i> COM port according to the COM port assigned to the barcode scanner in step 9. Press the <i>Save*</i> button.</p> 
11	<p>Close <i>DA1458x_DA1468x_CFG_PLT.exe</i> and open <i>DA1458x_DA1468x_GUI_PLT.exe</i>.</p>

DA1458x/DA1468x Production Line Tool

#	Action
12	<p>The initial <i>DA1458x_DA1468x_GUI_PLT.exe</i> screen will appear.</p>
13	<p>Press the <i>Barcode Scan</i> button on the bottom left corner. The following screen will appear.</p>
14	<p>Use the barcode scanner instrument to scan four different homekit setup codes with specific format as this was described in Table 17. Four different example codes are given next.</p> <div style="display: flex; flex-wrap: wrap; justify-content: space-around;"> <div style="text-align: center;"> <p>45953404LU09G1A000096</p> </div> <div style="text-align: center;"> <p>23793852LU09G1A000161</p> </div> <div style="text-align: center;"> <p>44613980LU09G1A000011</p> </div> <div style="text-align: center;"> <p>56795235LU09G1A000038</p> </div> </div>

DA1458x/DA1468x Production Line Tool

#	Action																																			
15	<p>When the barcodes, given in step 14, are scanned using the barcode scanner instrument, the GUI PLT will be as shown next.</p> <p>The screenshot shows the following data:</p> <table border="1"> <thead> <tr> <th>DUT</th> <th>BD Address</th> <th>Memory Data</th> <th>Result</th> </tr> </thead> <tbody> <tr> <td>13</td> <td>00:00:00:00:00:01</td> <td>45953404LU09G1A00009</td> <td>OK</td> </tr> <tr> <td>14</td> <td>00:00:00:00:00:02</td> <td>23793852LU09G1A00016</td> <td>OK</td> </tr> <tr> <td>15</td> <td>00:00:00:00:00:03</td> <td>44613980LU09G1A00001</td> <td>OK</td> </tr> <tr> <td>16</td> <td>00:00:00:00:00:04</td> <td>56795235LU09G1A00003</td> <td>OK</td> </tr> </tbody> </table> <table border="1"> <thead> <tr> <th>GU</th> <th>COM Port</th> <th>Status</th> <th>Result</th> </tr> </thead> <tbody> <tr> <td></td> <td>COM4</td> <td></td> <td></td> </tr> </tbody> </table> <p>Buttons: PREV, END, NEXT</p>	DUT	BD Address	Memory Data	Result	13	00:00:00:00:00:01	45953404LU09G1A00009	OK	14	00:00:00:00:00:02	23793852LU09G1A00016	OK	15	00:00:00:00:00:03	44613980LU09G1A00001	OK	16	00:00:00:00:00:04	56795235LU09G1A00003	OK	GU	COM Port	Status	Result		COM4									
DUT	BD Address	Memory Data	Result																																	
13	00:00:00:00:00:01	45953404LU09G1A00009	OK																																	
14	00:00:00:00:00:02	23793852LU09G1A00016	OK																																	
15	00:00:00:00:00:03	44613980LU09G1A00001	OK																																	
16	00:00:00:00:00:04	56795235LU09G1A00003	OK																																	
GU	COM Port	Status	Result																																	
	COM4																																			
16	<p>If something goes wrong, either navigate to the different DUT Memory Data cells using the <i>PREV/NEXT</i> buttons or press the <i>END</i> button and then the <i>Barcode Scan</i> button again to restart the process. The previous scanned data will be erased. If everything went well just press the <i>END</i> button. The tool will return to its initial screen as shown in step 12.</p>																																			
17	<p>Press the Space keyboard key to start the PLT tests. The PLT process will proceed.</p> <p>The screenshot shows the following data:</p> <table border="1"> <thead> <tr> <th>DUT</th> <th>BD Address</th> <th>Code</th> <th>Status</th> <th>Result</th> </tr> </thead> <tbody> <tr> <td>13</td> <td>00:00:00:00:00:01</td> <td>0</td> <td>NOT ACTIVE</td> <td></td> </tr> <tr> <td>14</td> <td>00:00:00:00:00:02</td> <td>2</td> <td>COM PORT IDENTIFY STARTED</td> <td></td> </tr> <tr> <td>15</td> <td>00:00:00:00:00:03</td> <td>3</td> <td>COM PORT IDENTIFY OK</td> <td>PASS</td> </tr> <tr> <td>16</td> <td>00:00:00:00:00:04</td> <td>3</td> <td>COM PORT IDENTIFY OK</td> <td>PASS</td> </tr> </tbody> </table> <table border="1"> <thead> <tr> <th>GU</th> <th>COM Port</th> <th>Code</th> <th>Status</th> <th>Result</th> </tr> </thead> <tbody> <tr> <td></td> <td>COM4</td> <td>34</td> <td>RD TESTER COM LOOPBACK OK</td> <td>OK</td> </tr> </tbody> </table> <p>Buttons: BLE Tester, Temp, Voltmeter (all NOT USED)</p>	DUT	BD Address	Code	Status	Result	13	00:00:00:00:00:01	0	NOT ACTIVE		14	00:00:00:00:00:02	2	COM PORT IDENTIFY STARTED		15	00:00:00:00:00:03	3	COM PORT IDENTIFY OK	PASS	16	00:00:00:00:00:04	3	COM PORT IDENTIFY OK	PASS	GU	COM Port	Code	Status	Result		COM4	34	RD TESTER COM LOOPBACK OK	OK
DUT	BD Address	Code	Status	Result																																
13	00:00:00:00:00:01	0	NOT ACTIVE																																	
14	00:00:00:00:00:02	2	COM PORT IDENTIFY STARTED																																	
15	00:00:00:00:00:03	3	COM PORT IDENTIFY OK	PASS																																
16	00:00:00:00:00:04	3	COM PORT IDENTIFY OK	PASS																																
GU	COM Port	Code	Status	Result																																
	COM4	34	RD TESTER COM LOOPBACK OK	OK																																
18	<p>PLT will get the barcode scanned data for each DUT and call the <i>SetupCode_Generator_680.exe</i> to create four different binaries. The binaries will reside inside <i>DA1458x_DA1468x_PLT_v_4.x.x\executables\binaries</i>.</p> <p>The directory listing shows:</p> <table border="1"> <thead> <tr> <th>Name</th> <th>Date modified</th> <th>Type</th> <th>Size</th> </tr> </thead> <tbody> <tr> <td>GU</td> <td>08-Mar-17 4:49 PM</td> <td>File folder</td> <td></td> </tr> <tr> <td>23793852LU09G1A00016.bin</td> <td>08-Mar-17 5:18 PM</td> <td>BIN File</td> <td>1 KB</td> </tr> <tr> <td>44613980LU09G1A00001.bin</td> <td>08-Mar-17 5:18 PM</td> <td>BIN File</td> <td>1 KB</td> </tr> <tr> <td>45953404LU09G1A00009.bin</td> <td>08-Mar-17 5:18 PM</td> <td>BIN File</td> <td>1 KB</td> </tr> <tr> <td>56795235LU09G1A00003.bin</td> <td>08-Mar-17 5:18 PM</td> <td>BIN File</td> <td>1 KB</td> </tr> </tbody> </table>	Name	Date modified	Type	Size	GU	08-Mar-17 4:49 PM	File folder		23793852LU09G1A00016.bin	08-Mar-17 5:18 PM	BIN File	1 KB	44613980LU09G1A00001.bin	08-Mar-17 5:18 PM	BIN File	1 KB	45953404LU09G1A00009.bin	08-Mar-17 5:18 PM	BIN File	1 KB	56795235LU09G1A00003.bin	08-Mar-17 5:18 PM	BIN File	1 KB											
Name	Date modified	Type	Size																																	
GU	08-Mar-17 4:49 PM	File folder																																		
23793852LU09G1A00016.bin	08-Mar-17 5:18 PM	BIN File	1 KB																																	
44613980LU09G1A00001.bin	08-Mar-17 5:18 PM	BIN File	1 KB																																	
45953404LU09G1A00009.bin	08-Mar-17 5:18 PM	BIN File	1 KB																																	
56795235LU09G1A00003.bin	08-Mar-17 5:18 PM	BIN File	1 KB																																	

DA1458x/DA1468x Production Line Tool

#	Action																																									
19	<p>If everything finished with no error the following screen will be shown.</p> <p>The screenshot shows the following data tables:</p> <table border="1"> <thead> <tr> <th>DUT</th> <th>BD Address</th> <th>Code</th> <th>Status</th> <th>Result</th> </tr> </thead> <tbody> <tr> <td>13</td> <td>00:00:00:00:00:01</td> <td>215</td> <td>CUSTOM DATA WRITE OK</td> <td>PASS</td> </tr> <tr> <td>14</td> <td>00:00:00:00:00:02</td> <td>215</td> <td>CUSTOM DATA WRITE OK</td> <td>PASS</td> </tr> <tr> <td>15</td> <td>00:00:00:00:00:03</td> <td>215</td> <td>CUSTOM DATA WRITE OK</td> <td>PASS</td> </tr> <tr> <td>16</td> <td>00:00:00:00:00:04</td> <td>215</td> <td>CUSTOM DATA WRITE OK</td> <td>PASS</td> </tr> </tbody> </table> <table border="1"> <thead> <tr> <th>GU</th> <th>COM Port</th> <th>Code</th> <th>Status</th> <th>Result</th> </tr> </thead> <tbody> <tr> <td></td> <td>COM4</td> <td>26</td> <td>RD TESTER INIT OK</td> <td>OK</td> </tr> </tbody> </table> <table border="1"> <thead> <tr> <th>BLE Tester</th> <th>Temp</th> <th>Voltmeter</th> </tr> </thead> <tbody> <tr> <td>NOT USED</td> <td>NOT USED</td> <td>NOT USED</td> </tr> </tbody> </table> <p>Statistics: Pass: 4 Fail: 0 Total: 0 Left: 0 Runs: 1</p> <p>IC: DA14681-01 (AE) <input type="checkbox"/> COM Enum <input type="checkbox"/> GU Check <input type="checkbox"/> VBAT/UART Barcode Scan</p> <p>smartbond logo</p> <p>Retest failed: Disabled Test Time: 00:30:012</p>	DUT	BD Address	Code	Status	Result	13	00:00:00:00:00:01	215	CUSTOM DATA WRITE OK	PASS	14	00:00:00:00:00:02	215	CUSTOM DATA WRITE OK	PASS	15	00:00:00:00:00:03	215	CUSTOM DATA WRITE OK	PASS	16	00:00:00:00:00:04	215	CUSTOM DATA WRITE OK	PASS	GU	COM Port	Code	Status	Result		COM4	26	RD TESTER INIT OK	OK	BLE Tester	Temp	Voltmeter	NOT USED	NOT USED	NOT USED
DUT	BD Address	Code	Status	Result																																						
13	00:00:00:00:00:01	215	CUSTOM DATA WRITE OK	PASS																																						
14	00:00:00:00:00:02	215	CUSTOM DATA WRITE OK	PASS																																						
15	00:00:00:00:00:03	215	CUSTOM DATA WRITE OK	PASS																																						
16	00:00:00:00:00:04	215	CUSTOM DATA WRITE OK	PASS																																						
GU	COM Port	Code	Status	Result																																						
	COM4	26	RD TESTER INIT OK	OK																																						
BLE Tester	Temp	Voltmeter																																								
NOT USED	NOT USED	NOT USED																																								
20	Press the FINISHED button to return to the main screen.																																									

7.3.3 Running the GUI PLT and Executing Tests

The GUI PLT starts the test procedure when users press the *START* button. Before initiating the test procedure, the GUI PLT will assign BD addresses to the active DUTs and check for any wrong configuration parameters.

If Run scripts before testing starts is enabled, PLT will execute the selected script/executable, and wait until it finishes or times out, depending on the selections made in *Test Options*. If the script/executable has returned on time, PLT will check the return code. Values from 0 to 100 indicate a successful completion. Negative values or values larger than 100 indicate an error. In the case of an error (either time out or error returned result), a pop-up message will appear indicating the return code and the test procedure will not start.

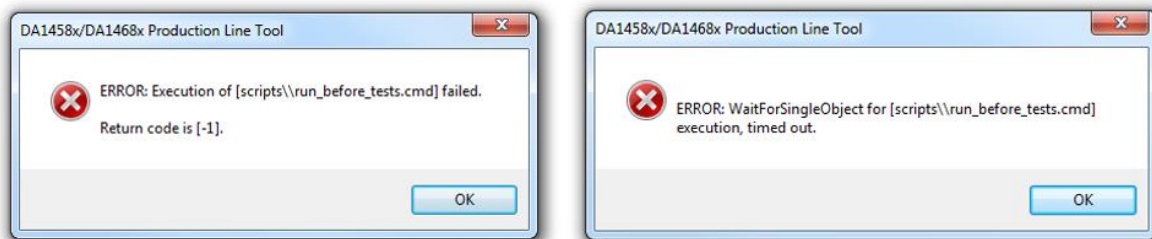

Figure 119: GUI PLT - Erroneous Messages in “run scripts before testing starts”

If any OTP burning test is scheduled, a pop-up message will inform the user and prompt for continuing (Figure 120).

DA1458x/DA1468x Production Line Tool

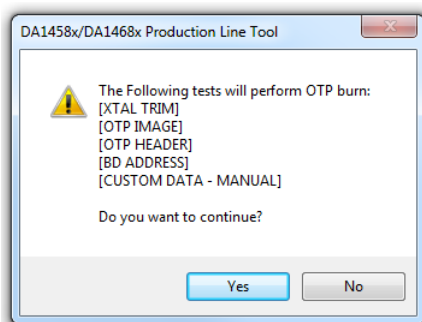

Figure 120: GUI PLT OTP Burn Warning Message

Immediately thereafter, the testing procedure will begin. PLT will update the status of the procedure for each DUT and the Golden Unit (Figure 121). The *START* button is replaced by a progress bar indicating the progress of the tests.

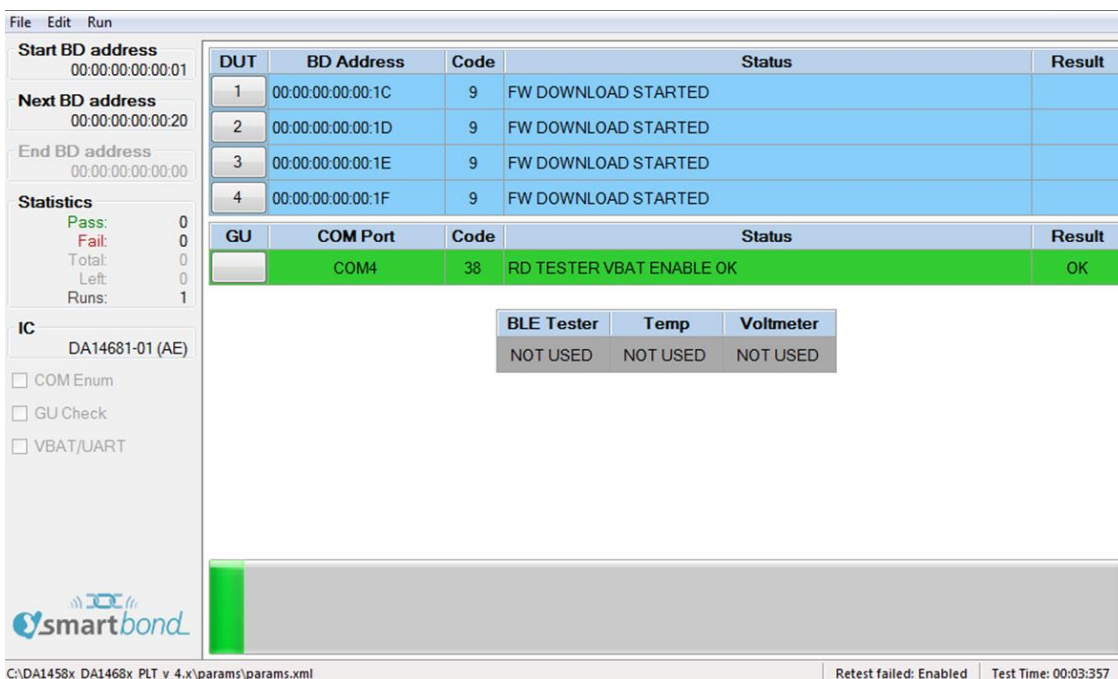

Figure 121: GUI PLT Testing (1 of 2)

If an error in a DUT is found (Figure 122), PLT will show the status code, a brief description of the error and the color of the DUT's status line will turn red. At all times the DUT number button can be pressed to access the [DUT Log File](#) to get more details about the parameters used, calculated values and the reason of failure in the case of an error.

DA1458x/DA1468x Production Line Tool

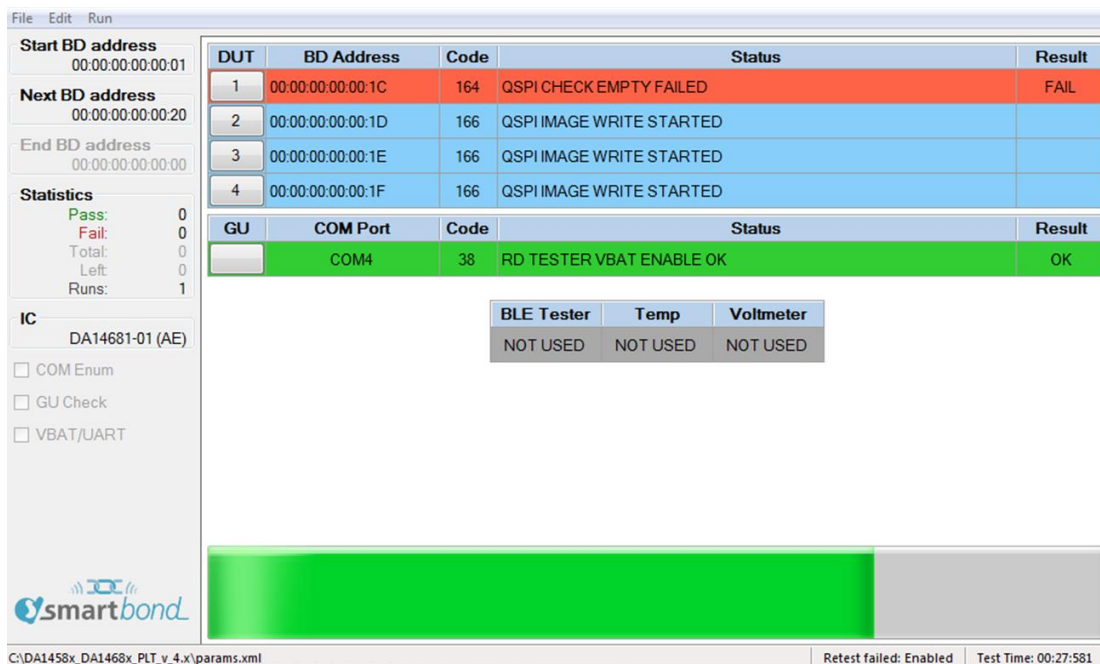

Figure 122: GUI PLT Testing (2 of 2)

After the testing procedure is completed (Figure 123), the progress bar shows *FINISHED* and the color will be red if any DUT has failed, otherwise it will be green. If there is an error and the *Retest failed DUTs* and *Ask to retry* options are enabled, a message will appear asking if the user would like to retest the failed DUTs, as shown in Figure 124. When the GUI PLT performs a retest run, all options (including the BD addresses) remain the same and only the tests that failed are retested. At this time, the *CSV File* and all the *DUT Log Files* will be updated.

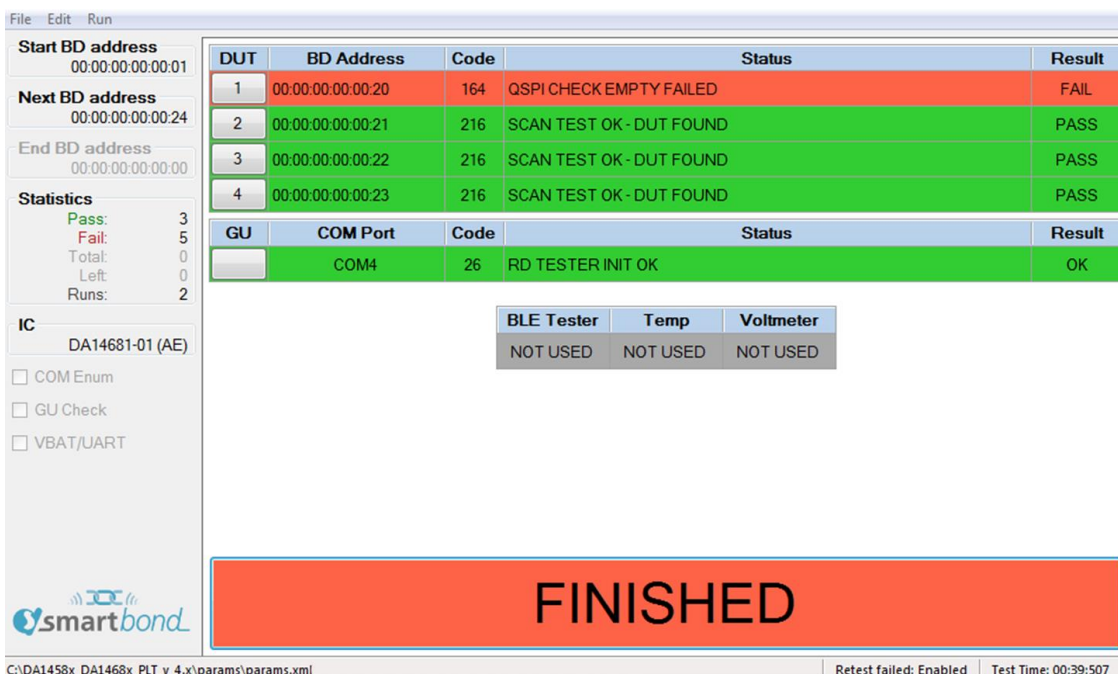

Figure 123: GUI PLT Tests Finished

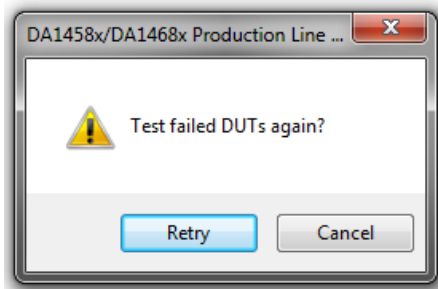

Figure 124: GUI PLT Retry Failed DUTs Message

If the DUT fails again, after the retest has finished the GUI PLT will remain in the *FINISHED* screen (Figure 123) with the *FINISHED* button shown in red.

If Run scripts when testing is finished is enabled, pressing the finished button will execute the selected script/executable. As with Run scripts before testing starts, PLT will wait until it finishes or times out, depending on the selections made in **Test Options**. If the script/executable has returned on time, PLT will check the return code. Zero value indicates a successful completion. Any other value is considered an error. In the case of an error (either time out or error result), a pop-up message will appear indicating the return code.

7.3.4 Debug Console

Section 7.2.12.6 shows the debug settings for all PLT applications including the GUI PLT. If at least one debug session is enabled with the output set to *Console*, the GUI PLT will open a new console window showing the desired debug information.

Figure 125 shows an example of the *Debug Console*. Depending on the type of the message, a different color is used: *DEBUG* messages are light blue, *INFO* messages are white and *ERROR* messages are red.

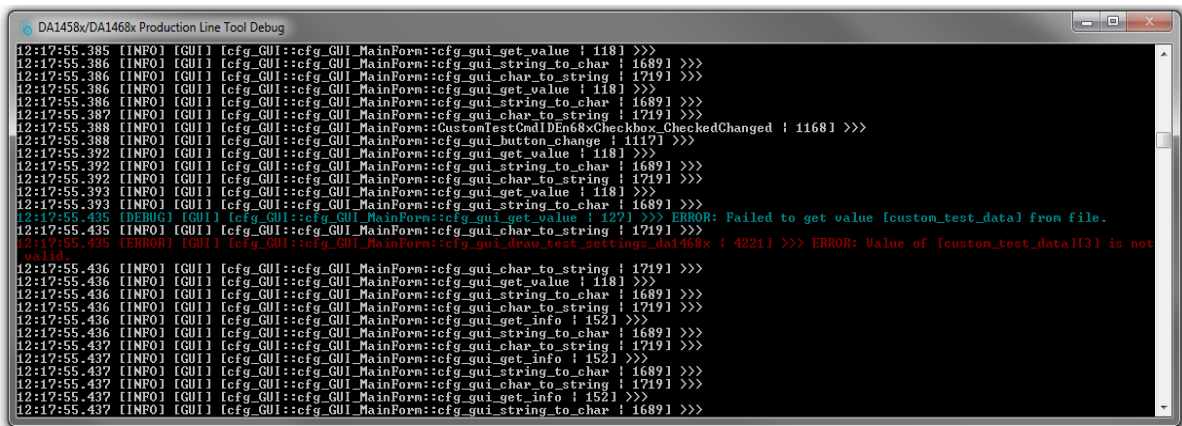

Figure 125: Debug Console

7.3.5 DUT Log File

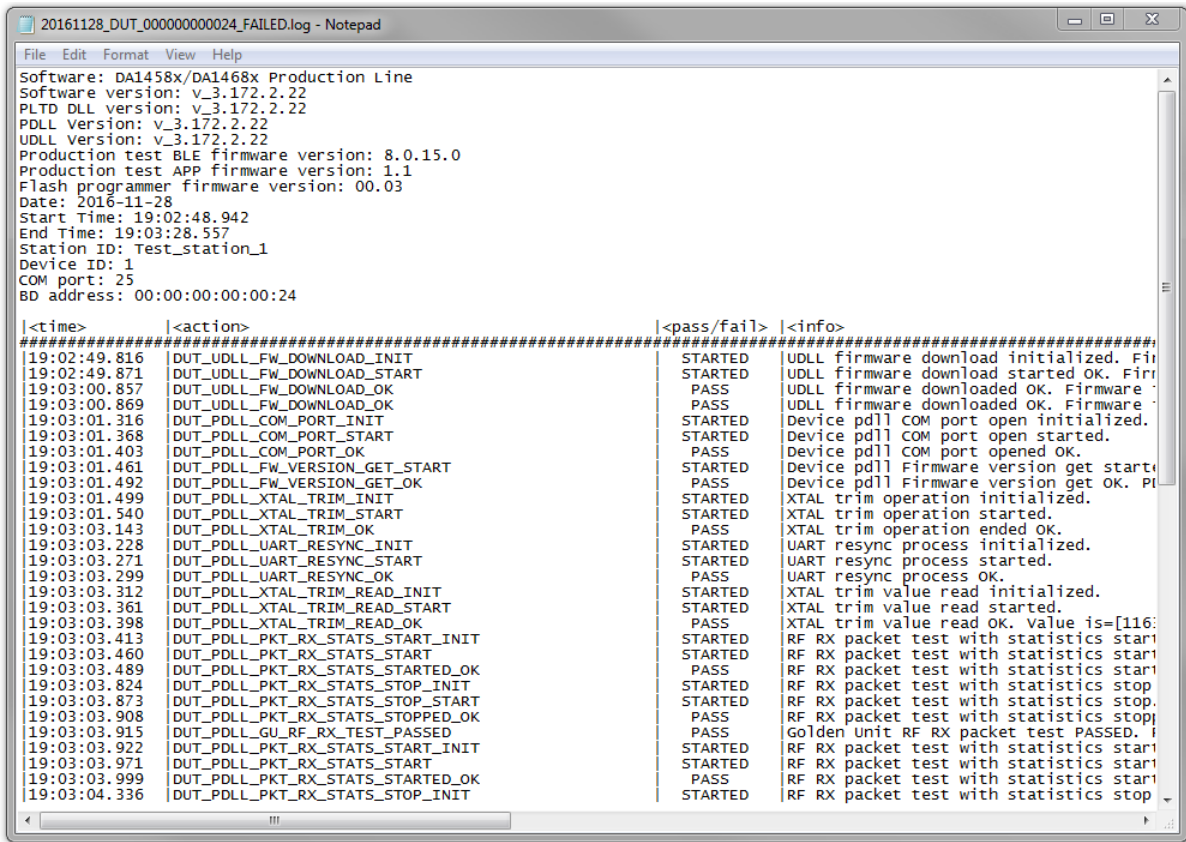

Figure 126: DUT Log File

Figure 126 shows a Log file generated for DUT1 during testing.

In the first few lines of the log, a header is created giving vital information about the PLT hardware and the software. It includes the firmware and software version, the station name and test dates and times. It also holds information about the DUT, such as the connector number in the PLT hardware, the BD address assigned to it and the Windows COM port. For the DUTs that have failed, the log file is renamed with the word "_FAILED" at the end for easier retrieval.

The Log file is created at the beginning of each test, containing only the header and all information available at the time of creation. As the device testing progresses, the status of each test is written at the end of the log file, including information about the DUT and a timestamp of the event. After the tests finish the header is updated with the end time of the test and the firmware versions, which were retrieved during testing.

DA1458x/DA1468x Production Line Tool

7.3.6 CSV File

Start time	End time	DUT	BD address	Overall st:	COM port	FW downl	FW path 2	FW versio	FW versio	QSPI eras	QSPI chec	QSPI burn	QSPI imag	FW dd
17:08:53	17:10:43	1	00:00:00:0	FAIL	25	PASS	C:\Users\j	PASS	00.03	PASS	FAIL			
17:08:53	17:10:43	2	00:00:00:0	FAIL	26	PASS	C:\Users\j	PASS	00.03	PASS	FAIL			
17:10:48	17:13:24	1	00:00:00:0	FAIL	25	PASS	C:\Users\j	PASS	00.03	PASS	FAIL			
17:10:48	17:13:24	2	00:00:00:0	FAIL	26	PASS	C:\Users\j	PASS	00.03	PASS	PASS	FAIL	binaries\pxp_r	
17:13:30	17:16:39	1	00:00:00:0	FAIL	25	PASS	C:\Users\j	PASS	00.03	PASS	FAIL			
17:13:30	17:16:39	2	00:00:00:0	FAIL	26	PASS	C:\Users\j	PASS	00.03	PASS	PASS	FAIL	binaries\pxp_r	
17:17:00	17:17:10	1	00:00:00:0	FAIL	25	FAIL	C:\Users\pdimopou\Desktop\DA1458x_DA1468x_PLT_v_4.0\source\production							
17:17:00	17:17:10	2	00:00:00:0	FAIL	26	PASS	C:\Users\j	FAIL						
17:17:55	17:18:13	1	00:00:00:0	FAIL	25	FAIL	C:\Users\pdimopou\Desktop\DA1458x_DA1468x_PLT_v_4.0\source\production							
17:17:55	17:18:13	2	00:00:00:0	FAIL	26	PASS	C:\Users\j	FAIL						
17:19:56	17:20:22	1	00:00:00:0	FAIL	25	PASS	C:\Users\j	PASS	00.03	PASS	FAIL			
17:19:56	17:20:22	2	00:00:00:0	PASS	26	PASS	C:\Users\j	PASS	00.03	PASS	PASS	PASS	binaries\pxp_r	
17:21:39	17:22:16	1	00:00:00:0	FAIL	25	PASS	C:\Users\j	PASS	00.03	PASS	FAIL			
17:21:39	17:22:16	2	00:00:00:0	FAIL	26	PASS	C:\Users\j	PASS	00.03	PASS	FAIL			
17:22:18	17:25:41	1	00:00:00:0	FAIL	25	PASS	C:\Users\j	PASS	00.03	PASS	FAIL			
17:22:18	17:25:41	2	00:00:00:0	FAIL	26	PASS	C:\Users\j	PASS	00.03	PASS	FAIL			
17:25:47	17:26:08	1	00:00:00:0	FAIL	25	PASS	C:\Users\j	PASS	00.03	PASS	FAIL			
17:25:47	17:26:08	2	00:00:00:0	PASS	26	PASS	C:\Users\j	PASS	00.03	PASS	PASS	PASS	binaries\pxp_r	
18:57:45	18:58:48	1	00:00:00:0	FAIL	25	PASS	C:\Users\j	PASS	00.03	PASS	FAIL			PASS
18:57:45	18:58:48	2	00:00:00:0	PASS	26	PASS	C:\Users\j	PASS	00.03	PASS	PASS	PASS	binaries\	PASS
18:57:45	18:58:48	3	00:00:00:0	PASS	27	PASS	C:\Users\j	PASS	00.03	PASS	PASS	PASS	binaries\	PASS
18:57:45	18:58:48	4	00:00:00:0	PASS	28	PASS	C:\Users\j	PASS	00.03	PASS	PASS	PASS	binaries\	PASS
18:59:40	19:00:20	1	00:00:00:0	FAIL	25	PASS	C:\Users\j	PASS	00.03	PASS	FAIL			PASS
18:59:40	19:00:20	2	00:00:00:0	PASS	26	PASS	C:\Users\j	PASS	00.03	PASS	PASS	PASS	binaries\	PASS

Figure 127: CSV File

Figure 127 shows an example of a generated CSV file. As with the DUT Log File, the PLT software and hardware information are shown along with valuable DUT information. The CSV file keeps information about all the production tests of a single day. A new CSV file will be created every day.

DA1458x/DA1468x Production Line Tool

7.4 CLI PLT Application

The CLI PLT (DA1458x_DA1468x_CLI_PLT.exe) is a Command Line Interface application with similar functionality and features as the GUI PLT. It performs the device testing and memory programming. At the same time, it allows users to monitor the test procedure in detail. It supports the same configuration file created from the CFG PLT and can run the same tests as the GUI PLT.

Note: Barcode scanner mode (described in [Scan Mode](#), [Custom Memory Data](#), and [Custom Memory Data](#)) is only available with [GUI PLT Application](#). [CLI PLT Application](#) does **NOT** support this feature.

[Figure 128](#) shows the initial screen of the CLI PLT software. The CLI PLT can be executed from a command line prompt, passing arguments externally and initiating the tests immediately. This is useful for scripting/batch files as shown in section [7.4.3](#).

Parameters are automatically loaded from the `params/params.xml` file when the CLI PLT starts. If there is a parameter error, a warning will be shown. It is recommended to run the 'x' command or start the CFG PLT before running the tests and check the configuration parameters. If a change is made to the `params.xml` configuration file while CLI is open, the file should be reloaded using the 'i' command. If any OTP burning test is scheduled, a message will inform the user and prompt for continuing.

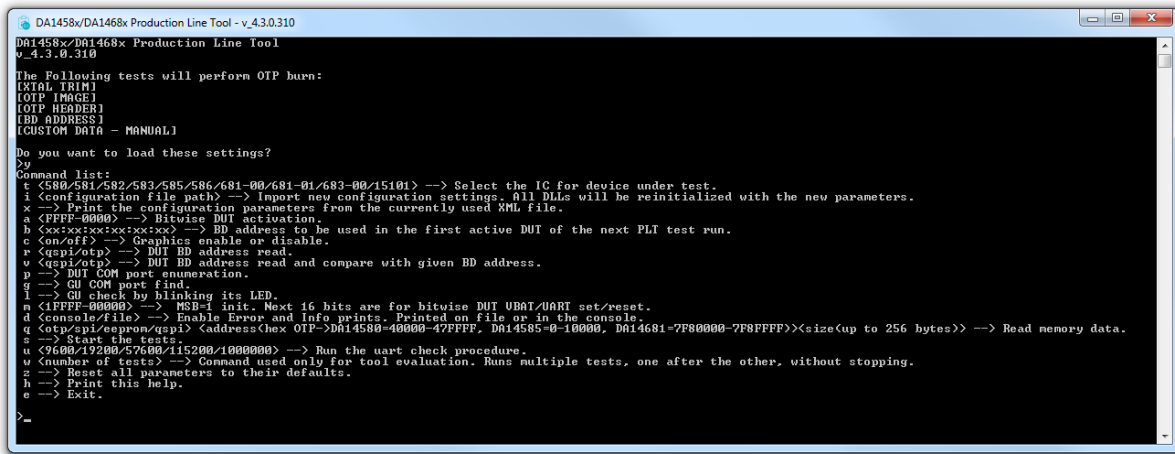

Figure 128: CLI Software Start Screen

7.4.1 CLI Commands

[Table 112](#) lists all available CLI commands. A list with brief description of these commands can be printed using the 'h' command.

Table 112: CLI Commands

Cmd	Arguments	Description
t	<ul style="list-style-type: none"> 580 581 582 583 585 586 681-00 681-01 683-00 15101 	<p>Selects the type of IC that the DUT uses.</p> <p>This option will change the DUT IC setting in the configuration file and reload all the settings if there is a switch from any DA1458x IC to a DA1468x IC and vice versa.</p> <p>Example: "t 580".</p>
i	Path to XML configuration file.	<p>Initializes the PLT with the parameters found in the <code>params.xml</code> file.</p> <p>Example: "i params\params.xml".</p>

DA1458x/DA1468x Production Line Tool

Cmd	Arguments	Description
x	<i>none</i>	Print the configuration parameters from the currently used XML file.
a	Hex values from "FFFF" to "0000".	Bitwise DUT activation. Sets the active DUTs to be tested. Examples: <ul style="list-style-type: none"> “a 1”: Only DUT 1 will be activated and tested. “a 9”: DUTs 1 and DUT 4 will be activated and tested.
b	xx:xx:xx:xx:xx:xx	Sets the start BD address of the first active DUT. Example: "b FE:00:11:22:33:44"
c	on/off	Enables or disables the graphics debug output of the CLI. Useful in the read BD address command <i>r</i> , in order to see only the DUT BD address returned and not the entire process. Example: "c on"
r	<ul style="list-style-type: none"> qspi otp 	Reads the BD addresses of the active DUTs. It is better to disable the graphics beforehand by running the command "c off". Example: "r qspi"
v	<ul style="list-style-type: none"> qspi otp 	Verify the BD addresses of the active DUTs. It is better to disable the graphics beforehand by running the command "c off". Example: "v qspi"
p	<i>none</i>	Execute the automatic DUT Window COM port enumeration.
g	<i>none</i>	Execute the automatic GU Window COM port enumeration.
l	<i>none</i>	Run the Golden Unit sanity check. The Golden Unit will start blinking its red LED.
m	First character: "1" or "0". Then hex value from "FFFF" to "0000".	MSB character should be '1' the first time this command is executed. Consecutive 'm' commands should have the MSB character set to '0'. The next 16 bits are used for bitwise DUT VBAT/UART enable/disable. Example: "m 1FFFF"
d	<ul style="list-style-type: none"> console file 	Use this option to enable error and info prints. Choose file output or console output. Only the <i>file</i> option is currently supported. Example: "d file"
q	First argument <ul style="list-style-type: none"> otp spi eeprom qspi Second argument <ul style="list-style-type: none"> The address offset in hexadecimal Third argument <ul style="list-style-type: none"> The size in bytes to read 	This option can read from any memory, for any address offset up to 256 bytes of data.
s	<i>none</i>	Starts the tests.
u	<ul style="list-style-type: none"> 9600 19200 57600 115200 1000000 	This command performs a UART check connection for all the active DUTs for a specific Baud rate.
w	Number of tests to run.	This command is used only for PLT evaluation. It starts multiple tests. These are executed one after the other without user intervention.

DA1458x/DA1468x Production Line Tool

Cmd	Arguments	Description
z	none	Resets all the XML parameters to their defaults.
h	none	Help print out. Prints the list of the CLI commands that are available.
e	none	Exits the application.

7.4.2 Running the CLI and Executing Tests

There are a number of options to be called in order to make sure that the CLI PLT is set up correctly. Each of following commands is explained in Table 112.

- Using the help command ('h') the entire CLI command list will be shown.

Example: >h

Set Console Options

- To redirect the debugging messages to the file use command 'd'. This option is going to replace the UI debug values in the configuration file.

Example: >d file

- To show or hide any prints in the Console window use command 'c' with on/off argument.

Example: >c on

Check, Reset, Reload and Change Settings

- Because the configuration file is automatically loaded, use the 'x' command (Figure 129) to see the loaded settings. Errors will be shown in red.

Example: >x

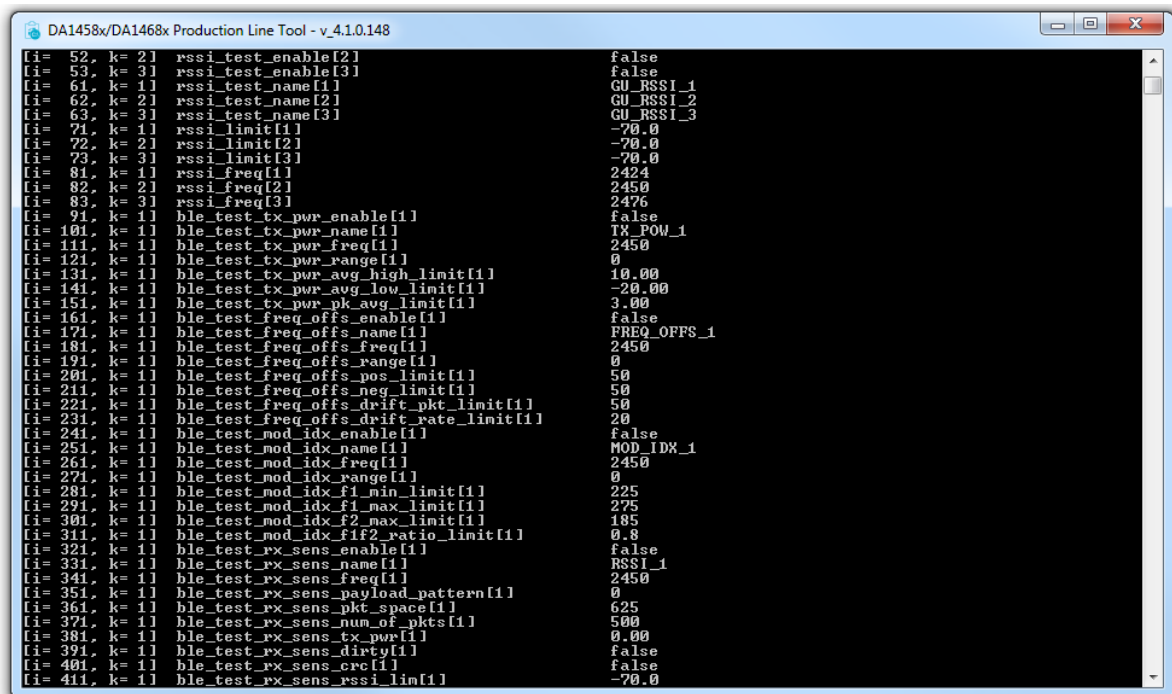

Figure 129: CLI PLT Print Settings (x Command)

- To Reset the XML parameters in the configuration file to their defaults use the 'z' command.

Example: >z

- To reload the configuration file or to load another one use the 'i' command.

DA1458x/DA1468x Production Line Tool

Example: `>i params/params.xml`

- To change only the selected device IC, use the 't xxx' command, where 'xxx' is the desired IC selection. If a change from DA1458x to DA1468x (and vice versa) is made, all the settings will be reloaded.

Example: `>t 580`

- To change the active DUTs use the 'a' command. As an argument a 16-bit hexadecimal value is used, which is the bitwise representation of the active DUTs with DUT 1 being the LSB. This command will replace the `dut_num_x` values in the configuration file.

The following example will enable only DUT1, DUT2, DUT15 and DUT 16.

Example: `>a C003`

- To change the BD address that will be used in the next run use the 'b' command. This option is going to replace the *BD address* and *Statistics* values in the configuration file.

Example: `>b 00:00:00:00:00:01`

Hardware Specific Tests

- To automatically find the Windows COM Port assigned to the Golden Unit, use the 'g' command. This command will replace the `gu_com_port` value in the configuration file.

Example: `>g`

- To verify that the Golden Unit COM port is found correctly and to check if the Golden Unit is ready run the 'l' command.

Example: `>l`

- To automatically find the Windows COM Port assigned for each DUT, use the 'p' command. This command will replace the `com_port_dut_x` values in the configuration file.

Example: `>p`

DUT	BD ADDRESS	CODE	STATUS	RESULT
2	00:00:55:00:00:01	0	NOT ACTIVE	
3	00:00:55:00:00:02	2	COM PORT IDENTIFY STARTED	
4	00:00:55:00:00:03	3	COM PORT IDENTIFY OK	PASS
GU	COM4	34	RD TESTER COM LOOPBACK OK	OK

Figure 130: CLI PLT DUT COM Port Enumeration ('p' Command)

- To run a UART error check use the 'u' command followed with a specific Baud rate.

Example: `>u 1000000`

PLT Production Tests

- To check if there is a BD address written in the active DUTs use the 'r' command. To read the BD addresses and verify that they are the same as the ones currently assigned use the 'v' command. Both commands use 'qspi' or 'otp' as argument to define the memory header.

The following example will read the BD address from the QSPI memory header and compare it with the one currently assigned to the DUTs.

Example: `>v qspi`

DA1458x/DA1468x Production Line Tool

DUT	BD ADDRESS	CODE	STATUS	RESULT
2	00:00:55:00:00:01	177	QSPI BD ADDRESS COMPARED OK	PASS
3	00:00:55:00:00:02	177	QSPI BD ADDRESS COMPARED OK	PASS
4	00:00:55:00:00:03	177	QSPI BD ADDRESS COMPARED OK	PASS
GU	COM4	26	RD TESTER INIT OK	OK

DUT	QSPI BD ADDRESS	GIVEN BD ADDRESS	STATUS
02	00:00:55:00:00:01	00:00:55:00:00:01	MATCH
03	00:00:55:00:00:02	00:00:55:00:00:02	MATCH
04	00:00:55:00:00:03	00:00:55:00:00:03	MATCH

return status = 0xFF1

Figure 131: CLI PLT Read and Compare BD Address in QSPI ('v' Command)

- Use the 's' command to begin testing with the current configuration. Figure 132 shows the CLI during the testing. After all the tests have finished, the result remains on the screen as shown in Figure 133.

DUT	BD ADDRESS	CODE	STATUS	RESULT
2	00:00:55:00:00:01	9	FW DOWNLOAD STARTED	
3	00:00:55:00:00:02	9	FW DOWNLOAD STARTED	
4	00:00:55:00:00:03	9	FW DOWNLOAD STARTED	
GU	COM4	38	RD TESTER VBAT ENABLE OK	OK

BLE TESTER	TEMP	VOLT
NOT USED	NOT USED	NOT USED

Figure 132: CLI PLT Testing

DUT	BD ADDRESS	CODE	STATUS	RESULT
2	00:00:55:00:00:01	216	SCAN TEST OK - DUT FOUND	PASS
3	00:00:55:00:00:02	216	SCAN TEST OK - DUT FOUND	PASS
4	00:00:55:00:00:03	216	SCAN TEST OK - DUT FOUND	PASS
GU	COM4	26	RD TESTER INIT OK	OK

BLE TESTER	TEMP	VOLT
NOT USED	NOT USED	NOT USED

DUT	QSPI BD ADDRESS	GIVEN BD ADDRESS	STATUS
02	00:00:55:00:00:01	00:00:55:00:00:01	MATCH
03	00:00:55:00:00:02	00:00:55:00:00:02	MATCH
04	00:00:55:00:00:03	00:00:55:00:00:03	MATCH

return status = 0xFF1

Figure 133: CLI PLT Testing Finished

- Use the 'q' command to read from any memory up to 156 bytes of data. The following example will read the BD address (6 bytes from offset 0x47FD4) of a DA14580 DUT.
Example: >q otp 47FD4 6

Other Test Commands

- Use the 'm' command to power on and access the DUTs to perform further testing. This will open the VBAT and the COM ports from the PLT hardware to the DUTs. As an argument, a '0' or '1' character is used to reset the PLT hardware. This is followed by a 16-bit hexadecimal number, which is the bitwise representation of the DUTs to use, with DUT 1 being the LSB.
In the following example, the PLT hardware will be reset and DUTs 1, 2, 15 and 16 will be used.
Example: >m 1C003

7.4.3 Using CLI Commands as Arguments

It is possible to start the CLI program with the commands described in section 7.4.2 as arguments. This is useful for scripting/batch files.

```
C:\executables>DA1458x_DA1468x_CLI_PLT.exe -a 0001 -b 00:00:55:00:00:01 -s -b 00:00:55:00:00:01 -v qspi
```

Figure 134: CLI with Commands as Arguments

The example shown in Figure 134 will perform the following commands:

3. '-a 0001': Set the DUT1 as the only active DUT.
4. '-b 00:00:55:00:00:01'. Assign as the first BD address to be assigned the 00:00:55:00:00:01. This BD address will be used in DUT1, as it is the only active DUT.
5. '-s': Perform the tests. BD address write in QSPI header should be enabled for the following test to pass.
6. '-b 00:00:55:00:00:01': After the tests finish the BD address will be incremented; this command will reset it to 00:00:55:00:00:01.
7. '-v qspi': Read only the BD address written in the QSPI header and compare it with the one assigned to the DUT1. These are the same.

DA1458x/DA1468x Production Line Tool

7.5 GU Upgrade Application

The GU Upgrade (GU_fw_upgrade.exe) is a Graphical User Interface application, which can be used to upgrade the firmware of the Golden Unit automatically, in contrast with [Golden Unit Upgrade Using Smart Snippets Toolbox](#) that describes a manual way to upgrade the firmware of the Golden Unit. It guides the user to configure, detect the PLT hardware and finally reprogram the SPI Flash memory onboard the PLT hardware with the Golden Unit firmware.

Note: Quick access to GU upgrade tool is provided by pressing the Upgrade GU firmware button, under Firmware Version - [Golden Unit](#) section in CFG PLT. Current version of the GU firmware can be seen using the Refresh button on the same section.

Note: This tool cannot upgrade PLT hardware version A. To update PLT hardware version A, follow the instructions in [Golden Unit Upgrade Using Smart Snippets Toolbox](#).

Introduction Page

The first page of the tool is an introduction page with the purpose of the tool. User can exit the tool at any step by pressing the cancel button or close the application using the X button from the windows bar at the top.

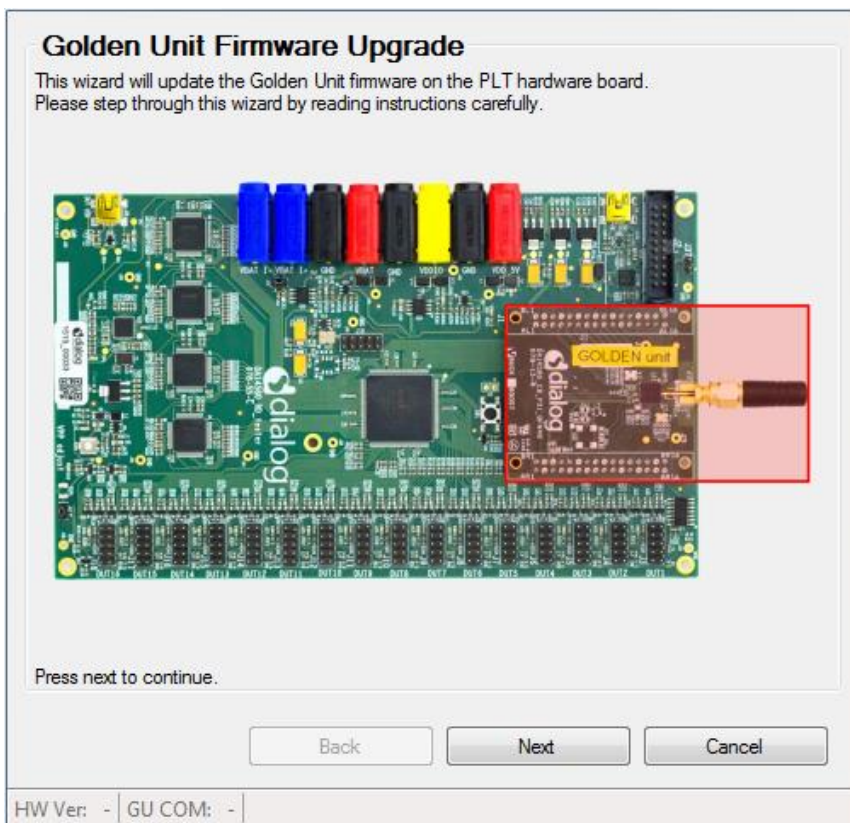

Figure 135: GU Upgrade - Introduction page

DA1458x/DA1468x Production Line Tool

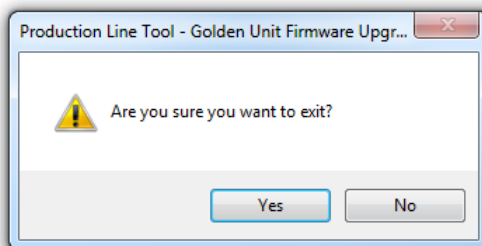

Figure 136: GU Upgrade - Exit Message

Hardware Version

Select the PLT hardware version. Depending on the version, some options may be missing or the tool may not support it. Selected hardware version will be shown on the left bottom corner of the tool at any of the following steps. As noted before PLT hardware version A is not supported by this tool.

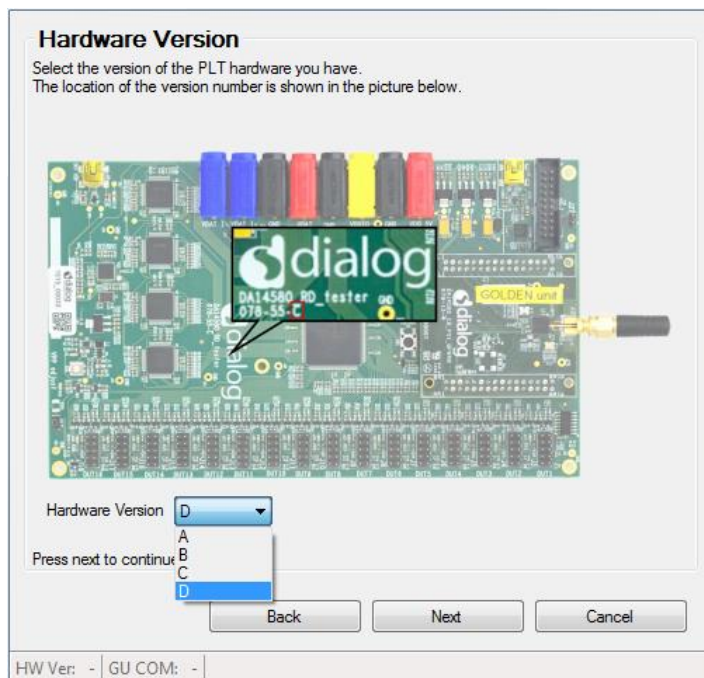

Figure 137: GU Upgrade - Hardware Version



Figure 138: GU Upgrade - Hardware Version Compatibility

Power Supply

Connect the power supply of the PLT, as described in [PLT Power Supply](#) and connect the jumpers as shown in [Figure 140](#) where applicable. Adjust the jumpers as proposed by the tool.

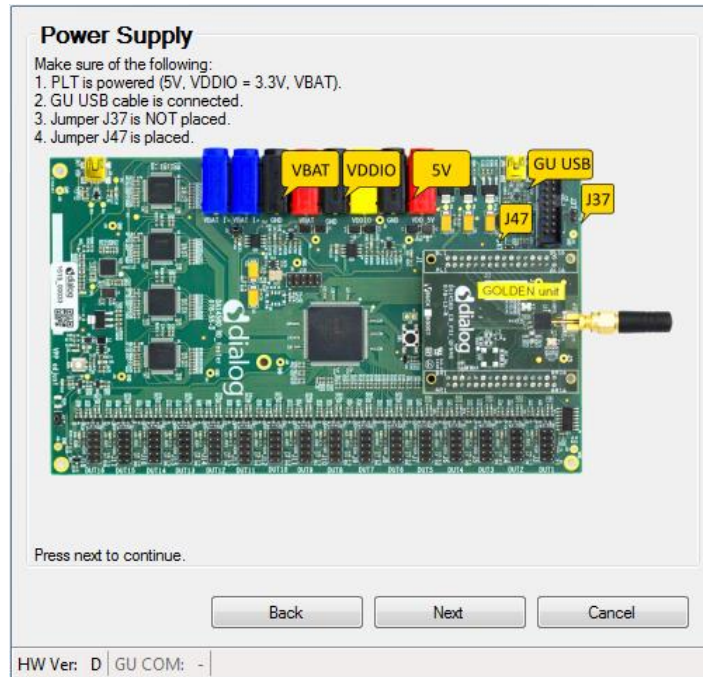

Figure 139: GU Upgrade - Power Supply

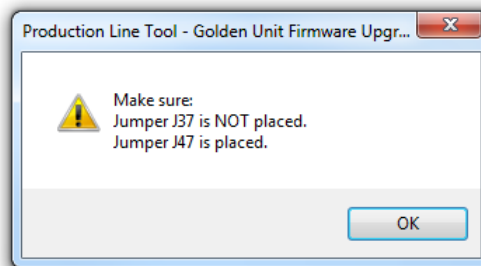

Figure 140: GU Upgrade - Power Supply Pop-Up

Golden Unit Reset

Select the way the GU will be reset. User can manually reset the GU, but PLT can do it automatically, which is the default selection. If the manual mode is selected, the user will be prompted any time the Golden Unit must be reset, to press the reset button located next to the Golden Unit on top of the PLT hardware.

DA1458x/DA1468x Production Line Tool

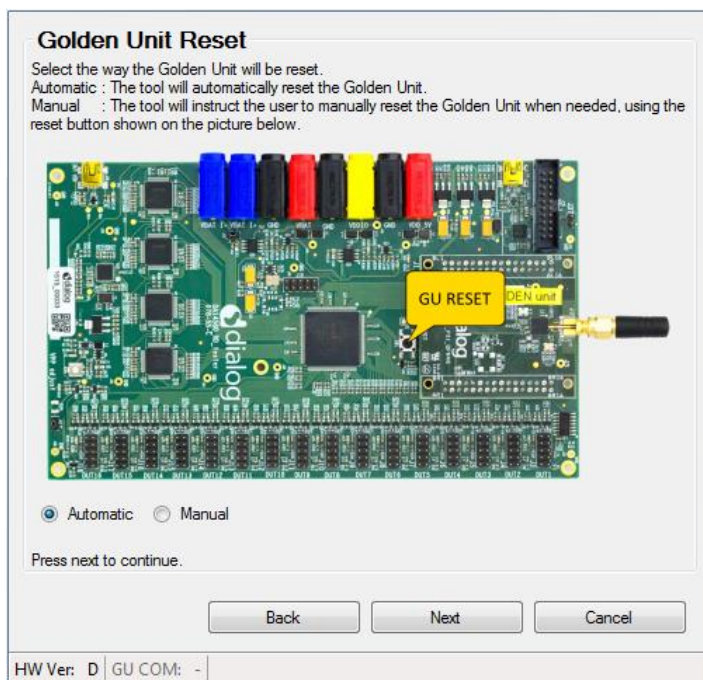

Figure 141: GU Upgrade - Golden Unit Reset

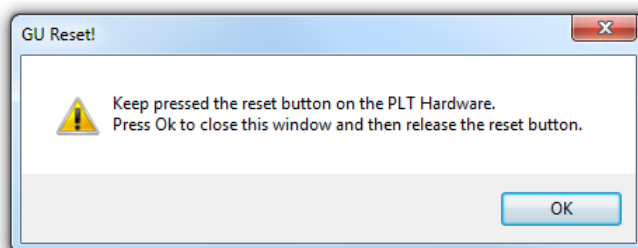

Figure 142: GU Upgrade - Golden Unit Reset Message for Manual Mode

GU COM Port

Find the windows assigned GU COM port. User can either select it from the dropdown list or use the *Auto* button to find it using the serial number as described in [Automatic GU COM Port Find](#). GU COM port can be also verified using the *Check* button. Selected GU COM port will be shown on the left bottom corner of the tool.

DA1458x/DA1468x Production Line Tool

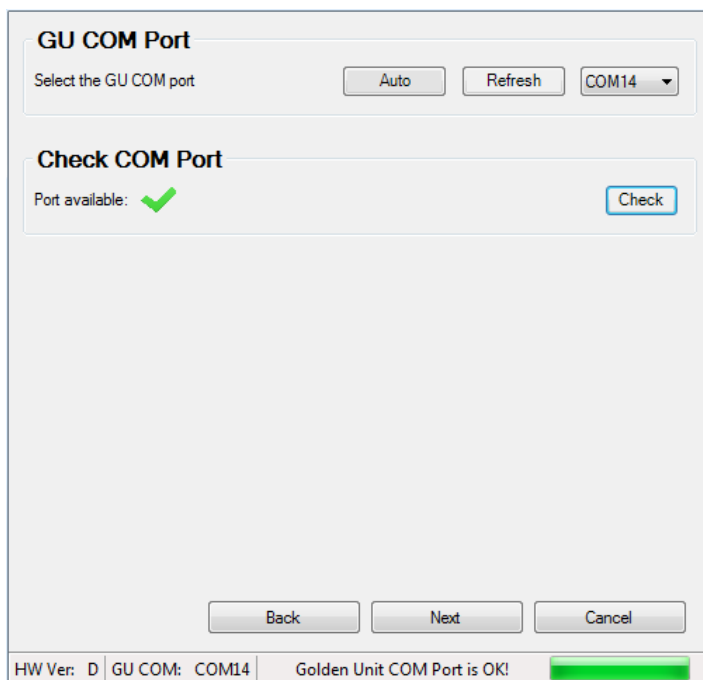

Figure 143: GU Upgrade - GU COM Port

Burn Firmware

This is the final step. Select the binary to burn.

Pressing the Burn button, will erase the SPI Flash on the PLT hardware, program it with the new firmware selected before, and then read it back to verify that the contents written are the same as those in the binary.

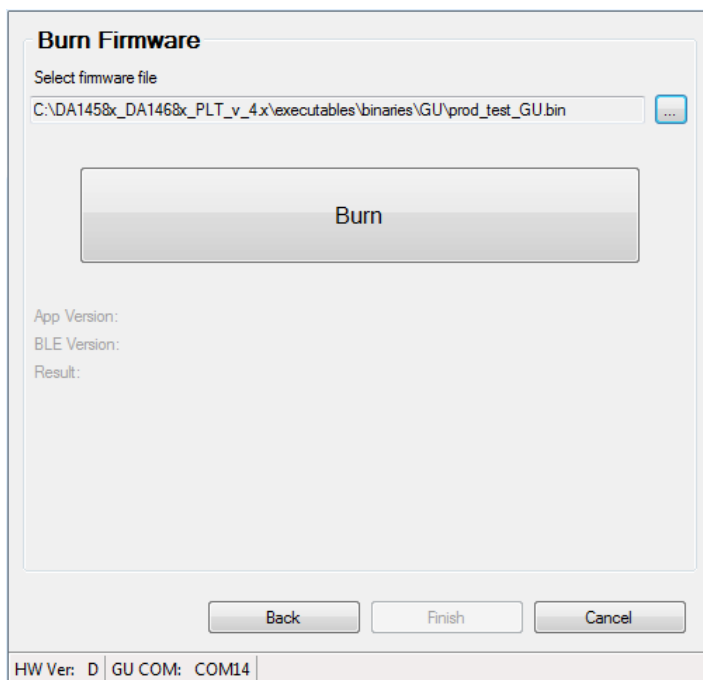

Figure 144: GU Upgrade - Burn Firmware

DA1458x/DA1468x Production Line Tool

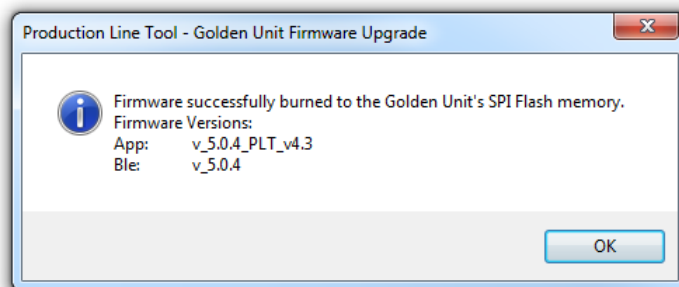

Figure 145: GU Upgrade - Burn Firmware Pop-Up Message

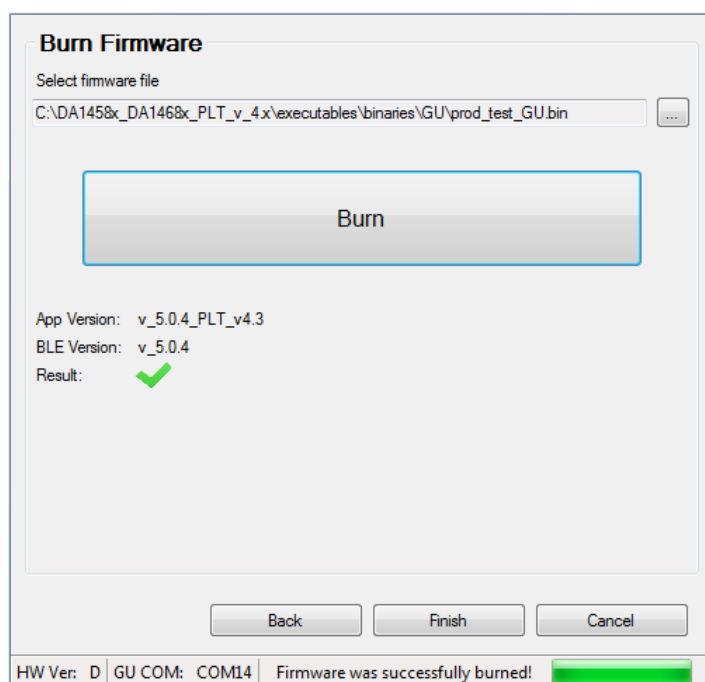

Figure 146: GU Upgrade - Burn Firmware Success

After the SPI flash program procedure is finished, a pop-up message will appear with the result of the programming procedure. If the SPI flash was programmed successfully, the pop-up message will also show the version of the new Golden Unit firmware (Figure 145).

DA1458x/DA1468x Production Line Tool

8 Example Usage

In this section, a simple example of the PLT will be described using two DA14580 devices. The example test procedure is explained step-by-step in [Table 113](#).

The tests to run in this example are the XTAL trim, RF RSSI test, SPI erase, SPI check empty and SPI image write.

Two DUTs will be used at PLT DUT connector positions DUT1 and DUT2.

Table 113: DA14580 PLT Example Usage

Step	Description		
Hardware Connections			
1	Connect both DUTs to the PLT hardware as shown in DA1458x DK Pro Motherboard Connection . Four cables are needed. In order to use the SPI Flash memory a custom triple-jumper must be used.		
CFG GUI Settings			
2	Open CFG PLT and make the following selections.		
3			<p>Device IC Select DA14580 and then Save.</p> <p>Golden Unit COM Port Press the Auto Button and then Save.</p> <p>Active DUTs Enable only DUT1 and DUT2 and Save.</p> <p>DUT COM Ports Press Enum button and then Save.</p>
	<p>Hardware Setup</p> <p>▲ Station Identification Station ID <input type="text" value="Test_station_1"/></p> <p>▲ Device IC Device IC <input type="text" value="DA14580"/></p> <p>▲ Golden Unit COM Port Set the GU COM port <input type="button" value="Auto"/> <input type="button" value="Refresh"/> <input type="text" value="COM14"/></p> <p>Firmware Version App: <input type="text"/> BLE: <input type="text"/> <input type="button" value="Refresh"/> <input type="button" value="Upgrade GU Firmware"/></p> <p>▲ Active DUTs <input checked="" type="checkbox"/> DUT 1 <input type="checkbox"/> DUT 5 <input type="checkbox"/> DUT 9 <input type="checkbox"/> DUT 13 <input checked="" type="checkbox"/> DUT 2 <input type="checkbox"/> DUT 6 <input type="checkbox"/> DUT 10 <input type="checkbox"/> DUT 14 <input type="checkbox"/> DUT 3 <input type="checkbox"/> DUT 7 <input type="checkbox"/> DUT 11 <input type="checkbox"/> DUT 15 <input type="checkbox"/> DUT 4 <input type="checkbox"/> DUT 8 <input type="checkbox"/> DUT 12 <input type="checkbox"/> DUT 16</p> <p>▲ DUT COM Ports DUT 1 <input type="text" value="44"/> DUT 5 <input type="text" value="0"/> DUT 9 <input type="text" value="0"/> DUT 13 <input type="text" value="0"/> DUT 2 <input type="text" value="45"/> DUT 6 <input type="text" value="0"/> DUT 10 <input type="text" value="0"/> DUT 14 <input type="text" value="0"/> DUT 3 <input type="text" value="0"/> DUT 7 <input type="text" value="0"/> DUT 11 <input type="text" value="0"/> DUT 15 <input type="text" value="0"/> DUT 4 <input type="text" value="0"/> DUT 8 <input type="text" value="0"/> DUT 12 <input type="text" value="0"/> DUT 16 <input type="text" value="0"/> <input type="button" value="Enum"/> <input type="button" value="Reset"/></p>		
4	<p>VBAT/Reset Mode</p> <p>▲ VBAT/Reset Mode VBAT low duration <input type="text" value="2000"/> ms Reset duration <input type="text" value="50"/> ms</p> <p>VBAT/Reset Mode <input type="text" value="VBAT Only"/></p>		<p>VBAT low duration Set a time for the POR that is sufficient enough for the DUTs to discharge their capacitors during the POR.</p> <p>VBAT/Reset Mode Since the DUTs will be powered from the PLT hardware and the Reset signal will not be used, use the VBAT only option.</p>
	<p>General</p>		
5			

DA1458x/DA1468x Production Line Tool

Step	Description		
		<p>Statistics</p> <p>Test Options</p>	<p>Press the Reset Button and then Save.</p> <p>Enable all options and then press Save.</p> <p>Production tests are required to be enabled for the XTAL Trim and the RF tests to run. Memory programming is required for the QSPI erase and check empty functions. Disable the rest of the options.</p>
6	UART		
		<p>UART Boot Pin Setup</p> <p>UART Baud Rate</p>	<p>TX: P0_4, RX: P0_5</p> <p>1000000</p>
7	Test Settings		
		<p>XTAL Trim</p> <p>RF Tests - Golden Unit</p>	<p>Check <i>Enable</i> in XTAL Trim. Select the same pin as the <i>UART Rx</i>, <i>P0_5</i>. <i>Burn to OTP</i> is disabled</p> <p>Only one test is enabled for this example.</p> <p>In Golden Unit:</p> <ul style="list-style-type: none"> • Check <i>Enable</i> • Select 2424 MHz as <i>frequency</i> • Set the <i>RSSI limit</i> to -70 dBm • Set <i>Packet error limit</i> to 10%

Step	Description
8	<p>Memory Functions</p>
	<p>Write 1 test</p> <p>Check Write enable Check Verify image Check Bootable image Make sure prox_reporter_580.bin is selected.</p>
9	<p>OTP Header</p>
	<p>General</p> <p>Disable all options</p>
	<p>BD address</p> <p>Disable all options</p>
<p>GUI PLT</p>	
10	<p>Open GUI PLT.</p>
	<p>Open GUI PLT.</p>

DA1458x/DA1468x Production Line Tool

Step	Description
11 cont.	
	<p>T3 After the firmware version was acquired the XTAL Trim test begins. The 500 ms reference pulse in the DUT RX channel is shown with blue letters. This test lasted for 2.3 s including the UART resync.</p>
	<p>T4 The RF RX RSSI test begins.</p>
<p>T5 The firmware download (<code>flash_programmer_58x.bin</code>) begins. Checking the log file the test lasted about 1.8 s. This can also be verified by looking the timing difference between T5-T4 at the first oscilloscope capture.</p>	
<p>T6 PLT begins the operation to get the version of the <code>flash_programmer.bin</code> firmware.</p>	
<p>T7 The SPI erase action begins. As with any SPI operation, first, a command to set the SPI bus pins is used and then the erase command. The blocks of data after the SPI erase and before the SPI check empty are SPI traffic on P0_5, which is the UART RX and the SPI MISO pin at the same time.</p>	
<p>T8 The SPI check empty action begins. As with any SPI operation, first, a command to set the SPI bus pins is used and then the check empty command. The blocks of data after the SPI check empty and before the SPI image write are SPI traffic on P0_5, which is the UART RX and the SPI MISO pin at the same time.</p>	

DA1458x/DA1468x Production Line Tool

Step	Description																															
T9	<p>The SPI image write operation begins. First, the image will be written, as shown in the picture above, and then the contents are read back for verification. The blocks of data after the SPI image write and before the SPI image verification are SPI traffic on P0_5, which is the UART RX and the SPI MISO pin at the same time.</p>																															
11 cont.	<p>The PLT run has finished.</p> <table border="1" data-bbox="544 506 1334 651"> <thead> <tr> <th>DUT</th> <th>BD Address</th> <th>Code</th> <th>Status</th> <th>Result</th> </tr> </thead> <tbody> <tr> <td>1</td> <td>00:00:55:00:00:01</td> <td>151</td> <td>SPI IMAGE WRITE OK</td> <td>PASS</td> </tr> <tr> <td>2</td> <td>00:00:55:00:00:02</td> <td>151</td> <td>SPI IMAGE WRITE OK</td> <td>PASS</td> </tr> </tbody> </table> <table border="1" data-bbox="544 595 1334 651"> <thead> <tr> <th>GU</th> <th>COM Port</th> <th>Code</th> <th>Status</th> <th>Result</th> </tr> </thead> <tbody> <tr> <td></td> <td>COM119</td> <td>26</td> <td>RD TESTER INIT OK</td> <td>OK</td> </tr> </tbody> </table> <table border="1" data-bbox="791 674 1083 725"> <thead> <tr> <th>BLE Tester</th> <th>Temp</th> <th>Voltmeter</th> </tr> </thead> <tbody> <tr> <td>NOT USED</td> <td>NOT USED</td> <td>NOT USED</td> </tr> </tbody> </table> <p style="text-align: center; font-size: 24px; font-weight: bold; background-color: #00FF00; padding: 10px;">FINISHED</p> <p style="font-size: 8px;">C:\DA1458x_DA1468x_PLT_v_4.x\params\params.xml Retest failed: Disabled Test Time: 00:14:965</p>	DUT	BD Address	Code	Status	Result	1	00:00:55:00:00:01	151	SPI IMAGE WRITE OK	PASS	2	00:00:55:00:00:02	151	SPI IMAGE WRITE OK	PASS	GU	COM Port	Code	Status	Result		COM119	26	RD TESTER INIT OK	OK	BLE Tester	Temp	Voltmeter	NOT USED	NOT USED	NOT USED
DUT	BD Address	Code	Status	Result																												
1	00:00:55:00:00:01	151	SPI IMAGE WRITE OK	PASS																												
2	00:00:55:00:00:02	151	SPI IMAGE WRITE OK	PASS																												
GU	COM Port	Code	Status	Result																												
	COM119	26	RD TESTER INIT OK	OK																												
BLE Tester	Temp	Voltmeter																														
NOT USED	NOT USED	NOT USED																														
	<p>After the tests have finished, the log and CSV files are fully updated. The GUI PLT test counter on the bottom right of the screen indicates that the test took approximately 15 s. This is verified from both the log files and the CSV file. Both files are shown below.</p>																															
	<pre> Software: DA1458x/DA1468x Production Line Software version: v_4.1.0.132 PLTD DLL version: v_4.1.0.132 PDLL Version: v_4.1.0.132 UDLL Version: v_4.1.0.132 Production test BLE firmware version: v_5.0.4 Production test APP firmware version: v_5.0.4_PLT_v4.1 Flash programmer firmware version: v_5.0.4_PLT_v4.1 Date: 2017-08-11 Start Time: 17:32:31.403 End Time: 17:32:49.038 Station ID: Test_station_1 Device ID: 1 COM port: 184 BD address: 00:00:55:00:00:01 </pre>																															

DA1458x/DA1468x Production Line Tool

Step	Description									
11 cont.		A	B	C	D	E	F	T1	G	
	1	Start time	End time	DUT	BD address	Overall status	COM port	FW download	1	
	2	18:54:14	18:54:29	1	00:00:55:00:00:01	PASS	25	PASS		
	3	18:54:14	18:54:29	2	00:00:55:00:00:02	PASS	26	PASS		
		H	T2	I	J	T3	K	L	T4	M
		FW path 1	FW version get 1	FW version 1	XTAL trim test	XTAL trim	GU RX test 1			
		C:\Users\pd	PASS	v_5.0.4	PASS	1426	PASS			
		C:\Users\pd	PASS	v_5.0.4	PASS	1346	PASS			
		N	T5	O	P	T6	Q			
		GU RX RSSI 1	FW download 2	FW path 2	FW version get 2					
		-31.82	PASS	C:\Users\pd	PASS					
		-21.87	PASS	C:\Users\pd	PASS					
		R	T7	S	T8	T9	U	V	T10	
		FW version 2	SPI erase 1	SPI empty 1	SPI burn 1	SPI image 1				
		v_3.0.11.554	PASS	PASS	PASS	binaries\prox_reporte				
	v_3.0.11.554	PASS	PASS	PASS	binaries\prox_reporte					

Appendix A Top-view of PLT PCB Version D

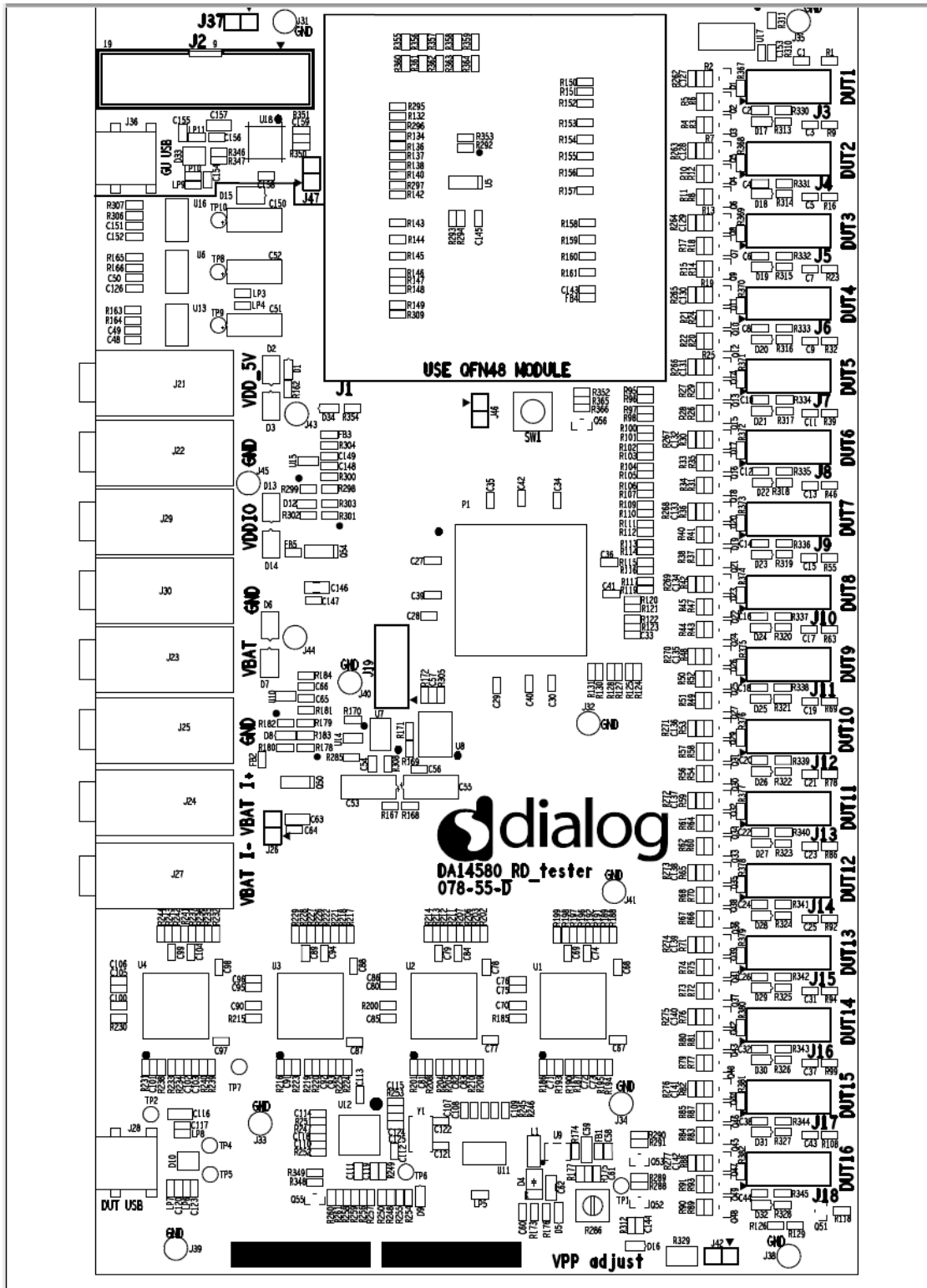

Figure 147: Top-view of PLT PCB Version D

Appendix B Electrical Schematics

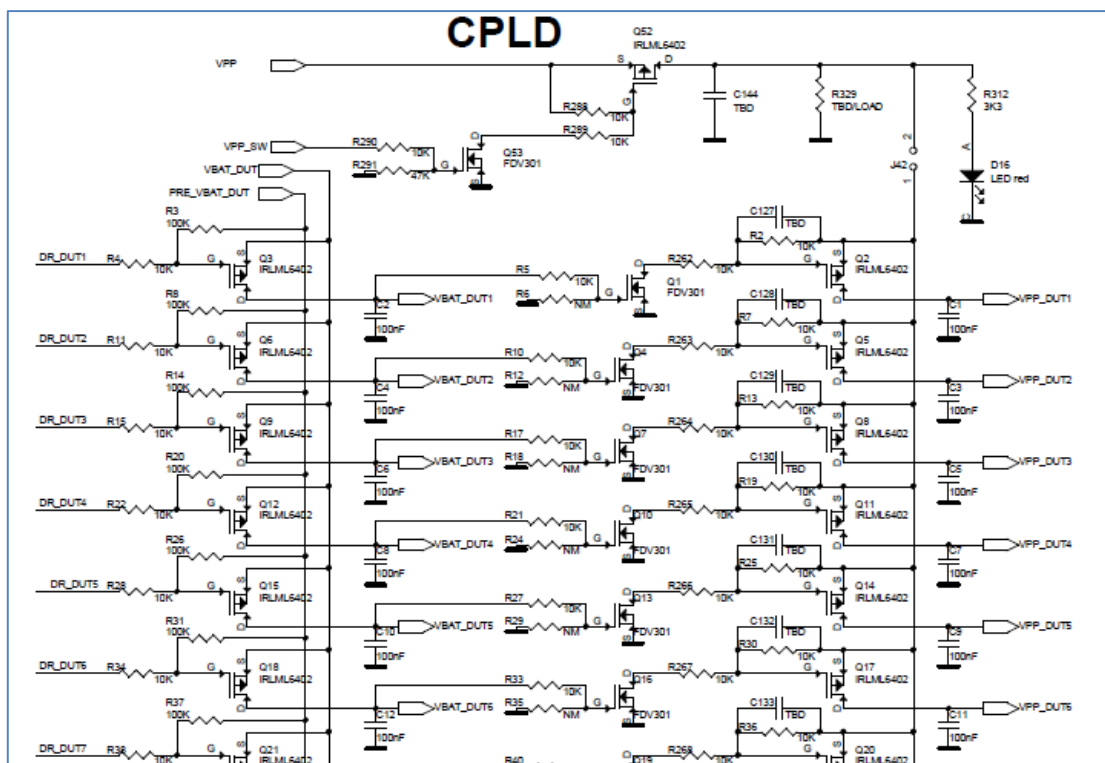

Figure 148: VBAT and VPP Control from CPLD

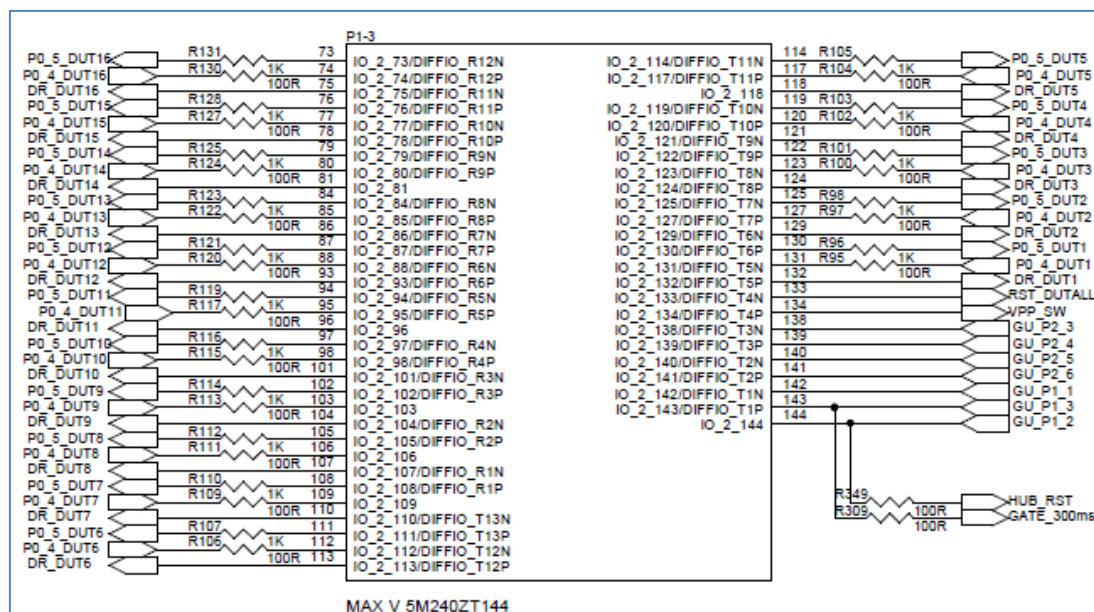

Figure 149: CPLD DUT UART Connections

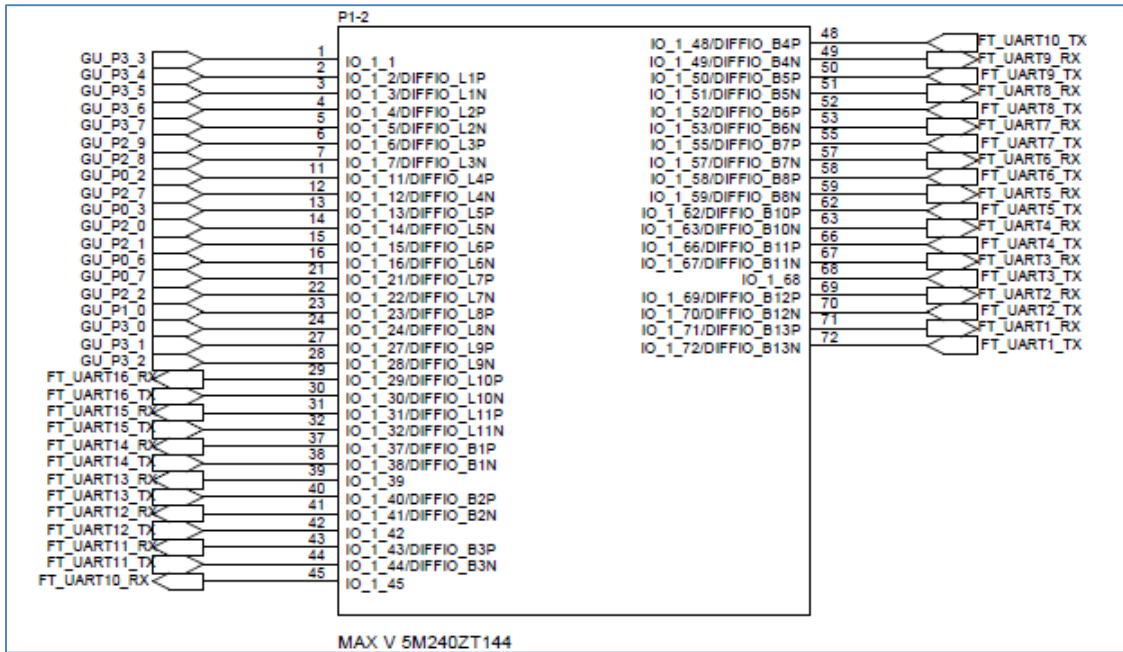

Figure 150: CPLD FTDI and GU Control Connections

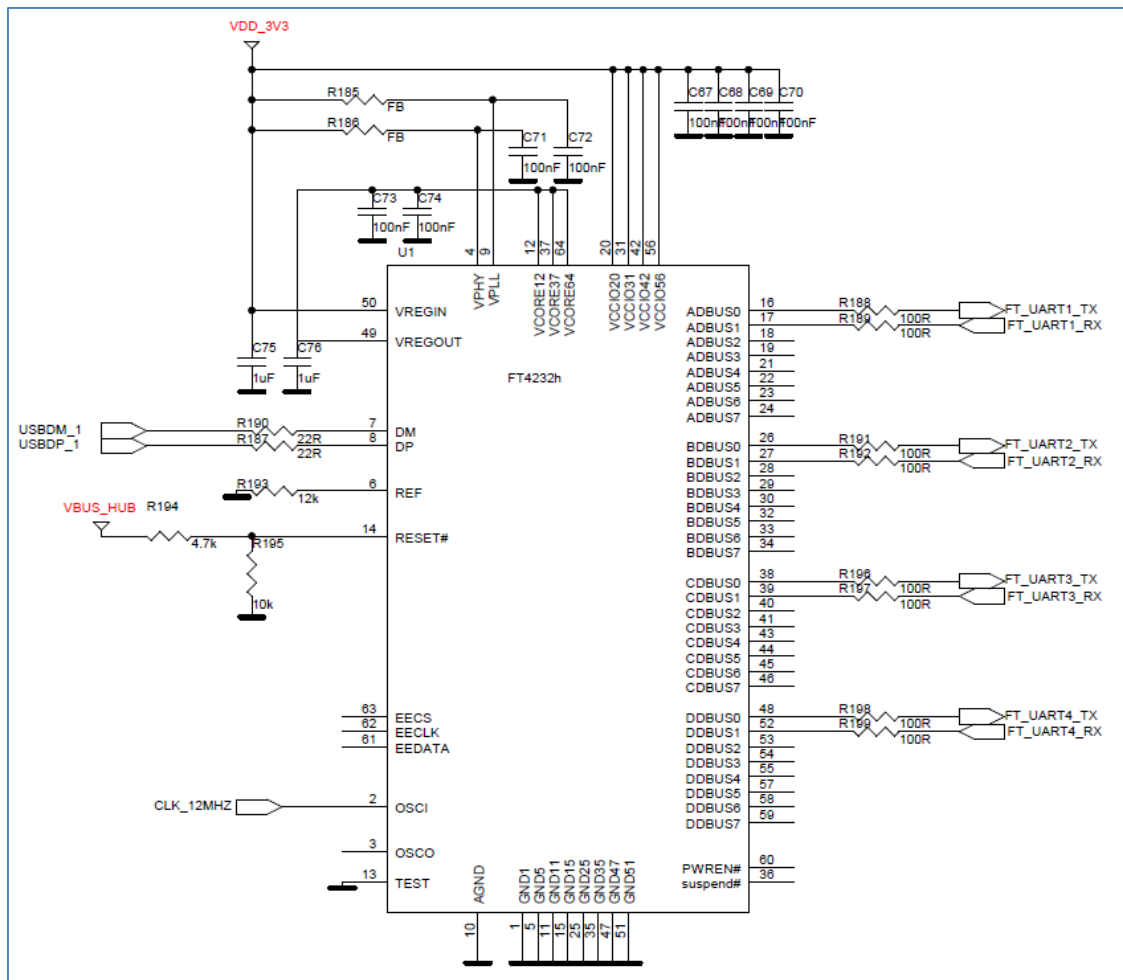

Figure 151: FTDI Chip for USB UART to DUTs 1, 2, 3 and 4

DA1458x/DA1468x Production Line Tool

USB HUB: provides 5V input for the 3.3V LDO and USB input-signals to the four Quad FTDI chips.

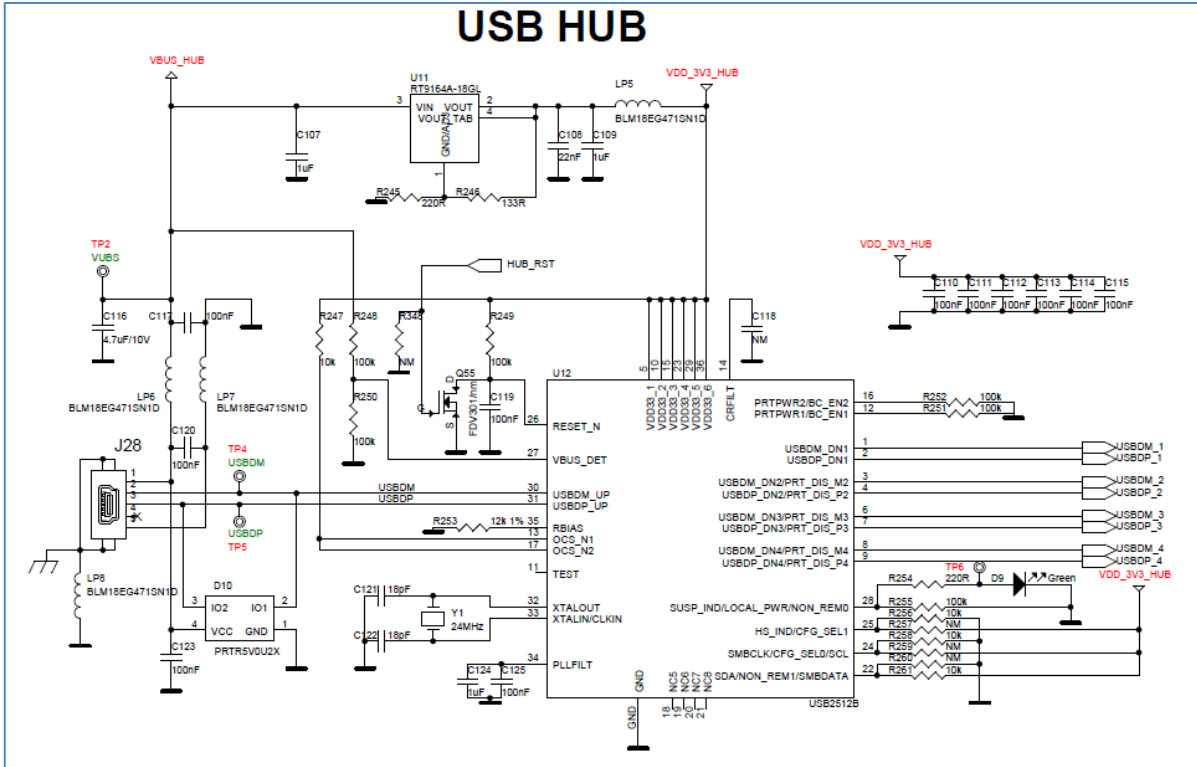

Figure 152: Quad USB HUB

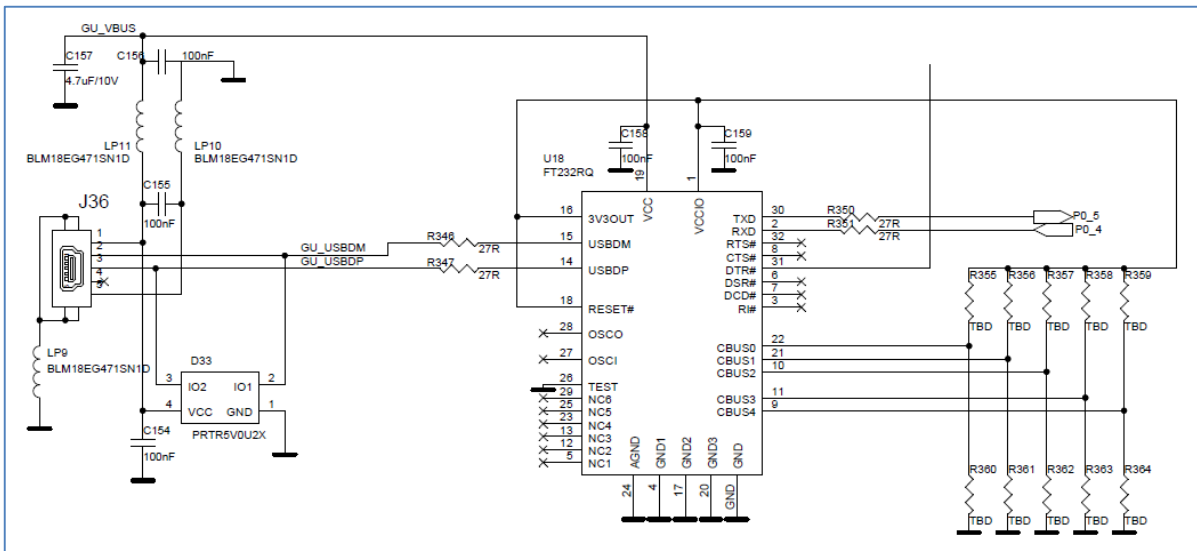

Figure 153: Golden Unit - Dedicated USB Port and FTDI Chip

DA1458x/DA1468x Production Line Tool

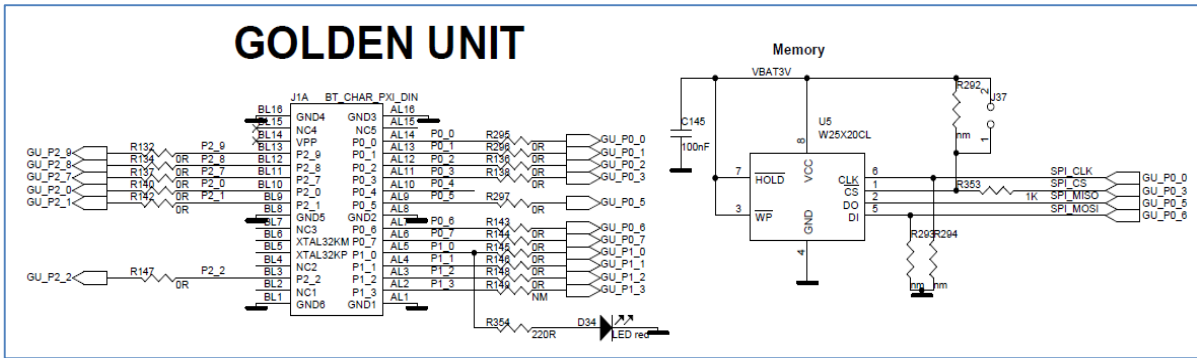

Figure 154: Golden Unit - GU LED and SPI Flash Memory

The Golden Unit SW (prod_test_GU.bin) is located in the SPI Flash memory mounted on the PLT hardware and is loaded into the GU's system RAM when powered on.

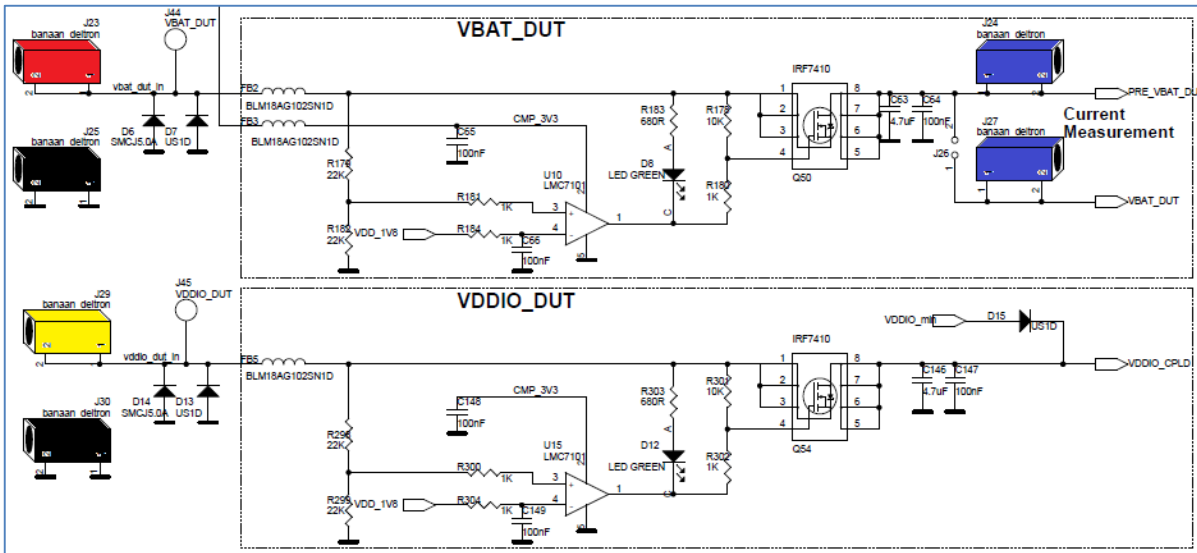

Figure 155: VBAT_DUT and VDDIO Supplies

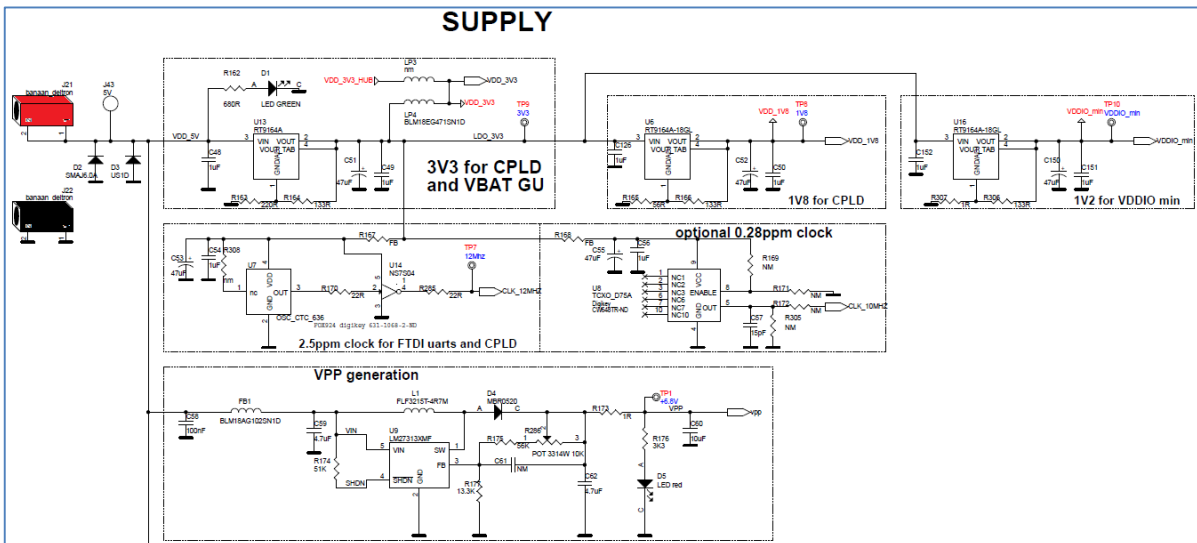

Figure 156: GU Supply and VPP Generation

Appendix C Hardware Modifications PLT Version D

In the PLT hardware version D, a small modification was made. Resistor R365 (10 kΩ) and jumper J47 were added in series to the GU reset circuit.



Figure 157: DA14580_RD_tester Version D

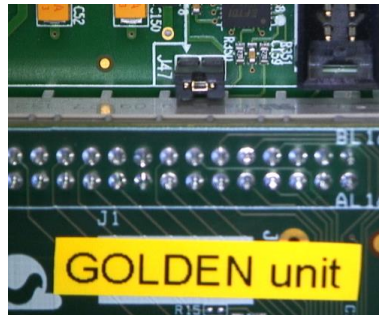

Figure 158: Jumper J47 Added Next to Golden Unit Socket

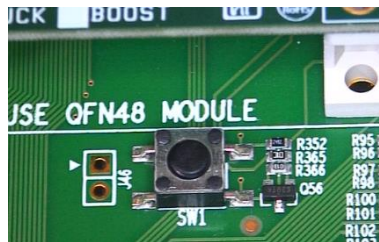

Figure 159: R365 (10 kΩ) Added Next to Reset Button

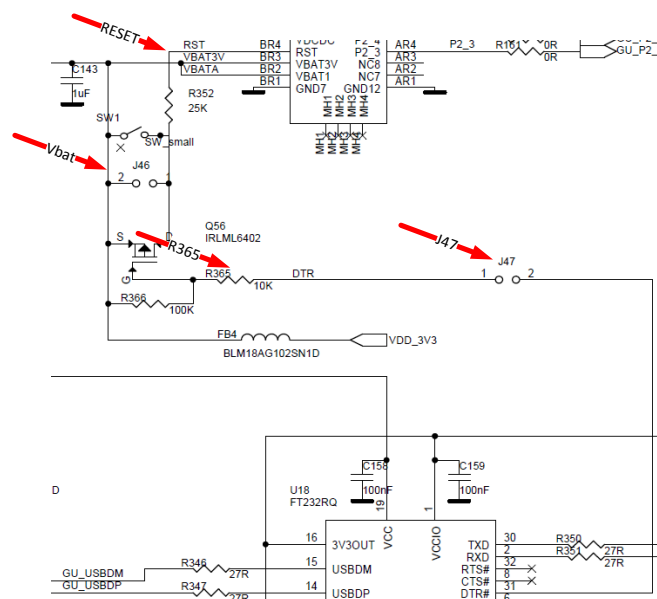

Figure 160: R365, J47 and RESET Shown in Electrical Schematic

DA1458x/DA1468x Production Line Tool

Appendix D Suggestions about Hardware and Cabling

When connecting the PLT to the DUTs, special care should be taken with regard to the cabling.

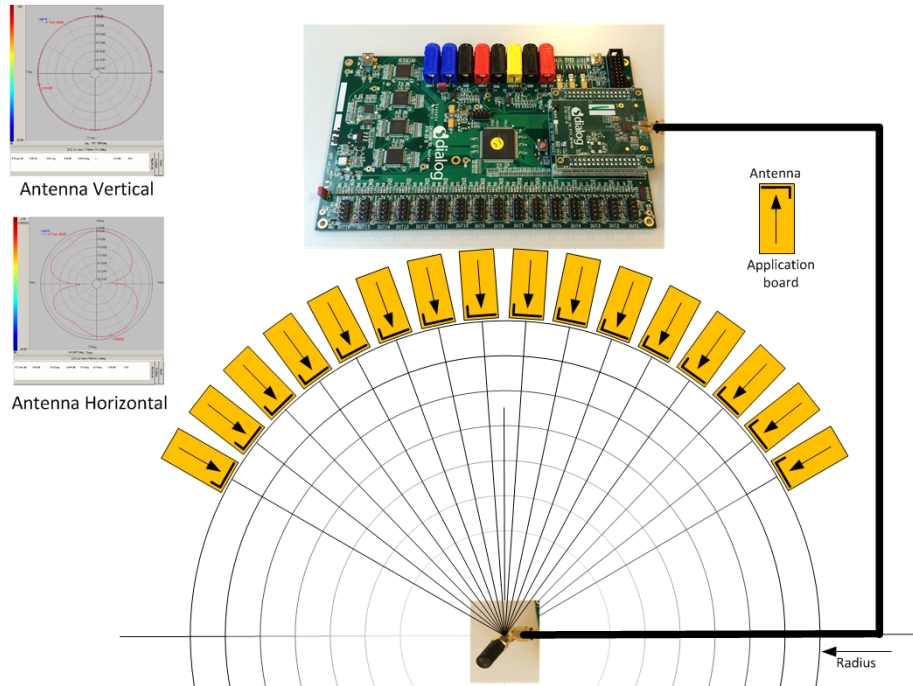

Figure 161: Possible Solution of Antenna on Cable and Fixed Radius of DUTs to Antenna

The user should realize that the PLT system is equipped with RF transmitters and receivers. These parts may induce noise on hardware and cables. The following aspects should be kept in mind:

- The direction of the GU antenna to the DUT antenna will influence the RSSI value.
- The distance of the DUT antenna to the GU antenna (radius) will influence the RSSI value.
- The control lines from the PLT to the DUTs must be kept as short as possible.
- A vertical GU antenna has different characteristics from a horizontal one. See Figure 161.

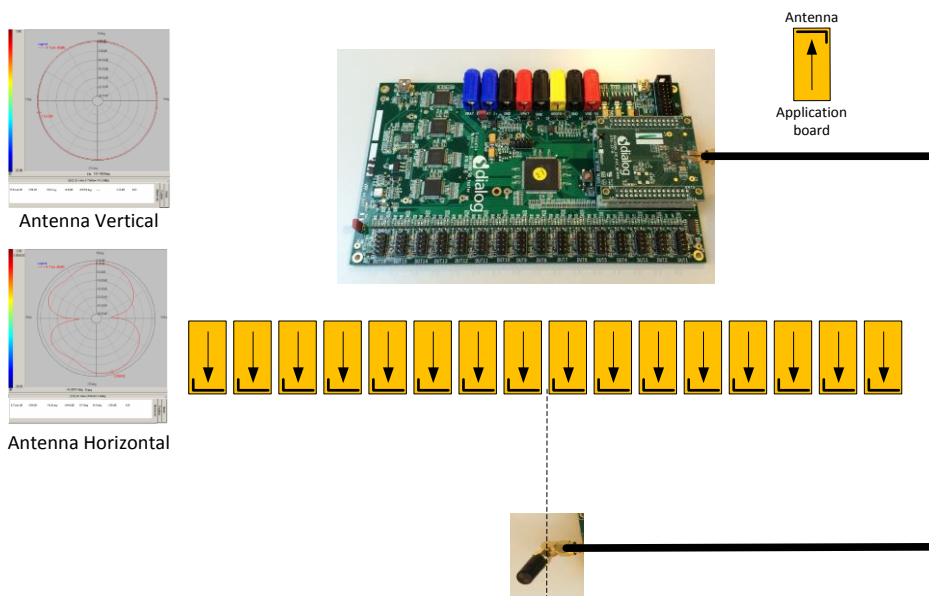

Figure 162: Possible Solution of Antenna on Cable and DUTs Put in Line

DA1458x/DA1468x Production Line Tool

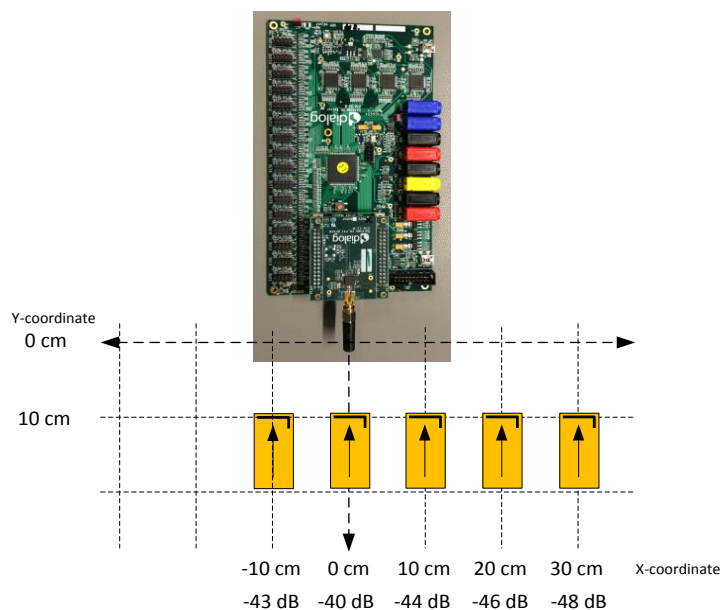

Figure 163: Example Locations and RSSI Readouts of Horizontal Antenna

Figure 163 shows the measured values from Table 114.

Table 114: RF Test RSSI Results

Test	Distance (cm)	Offset (cm)	RSSI (dBm)	Description
1	10	0	-40	DUT and GU boards are inline.
2	10	-10	-43	DUT moved 10 cm to the left relative to the GU.
3	10	10	-44	DUT moved 10 cm to the right relative to the GU.
4	10	20	-46	DUT moved 20 cm to the right relative to the GU.
5	10	30	-48	DUT moved 30 cm to the right relative to the GU.
6	10	normal	-40	DUT and GU boards are inline, functioning normally.
7	10	defect 1	-60 ~ -70	Coupling capacitor not soldered well, missing or damaged.
8	10	defect 2	~ -60	Short circuited shunt matching inductor (e.g. solder bridge)
9	10	defect 3	< -100	16 MHz crystal oscillator not working well. Received packets ~ 0.

Golden Unit output power = 0 dBm

For more details on the RF setup, refer to [12] and Appendix E.

DA1458x/DA1468x Production Line Tool

Appendix E RF Path Losses Calibration

To accurately perform radiated tests for 16 DUTs using the Golden Unit or a BLE tester, one should calibrate the setup in order to know what RSSI value can be expected for non-problematic devices. Because the distance and the position of each of the 16 DUTs to the GU RF antenna are different, the calibration process calculates the different path losses to compensate for these differences. The calculated values are applied to the Production Line Tool configuration as RF path losses (DA1458x - [Path Losses per DUT](#), DA1468x - [Path Losses per DUT](#)), which are actually added in the RSSI result.

This chapter describes the process to calculate the RF path losses for each different DUT position.

E.1 Prerequisites

Table 115 illustrates the prerequisites needed for performing the RF path loss calibration procedure.

Table 115: Prerequisites

#	Requirements	Description
1	1 PLT board	1 PLT board with Golden Unit. Power supply for the PLT. USB cables for the PLT to the PC.
2	<10 PCBA with 16 DUTs each	At least 10 PCBAs. The more PCBAs used the better. The PCBAs selected should all work as good as possible. If a fault device is identified on a PCBA that PCBA should be replaced.
3	1 shielded box	It must be big enough to fit the PCBA and the fixture. It should have one SMA female to female connector and a small hole to pass the DUT to PLT cable connections.
4	2 RF cables (1 optional)	One cable to be used from the PLT GU to the shielded box. One more cable to be used from the shielded box to the RF antenna. (This is optional since the RF antenna can be directly mounted into the shielded box RF SMA connector). The cables should have low attenuation at 2.5Ghz range (<2dB) and high shielding effectiveness (>60dB). Proposed cables are from Radiall. Cables datasheet: https://www.radiall.com/media/files/RFCableAssemblies%20D1C004XEe.pdf <ul style="list-style-type: none"> ● Flexible cable 2.6/50 D (RD316) P/N: C291 185 067 ● Flexible cable 2/50 D (124416 type) P/N: C291 146 087 ● Flexible cable 2.6/50 D (ECO316D: alternative to RD316) P/N: C291 999 905 ● Flexible cable 5/50 D (ECO142: alternative to RG142) P/N: C291 325 290 ● Flexible cable 5/50 D (Power 142: alternative to RG142) P/N: C291 325 270 ● Flexible cable 6/50 D (ECO230) P/N: C291 326 490
5	DUT fixture	A fixture to be placed inside the shielded box to easily connect the PCBAs to the PLT.

E.2 Setup

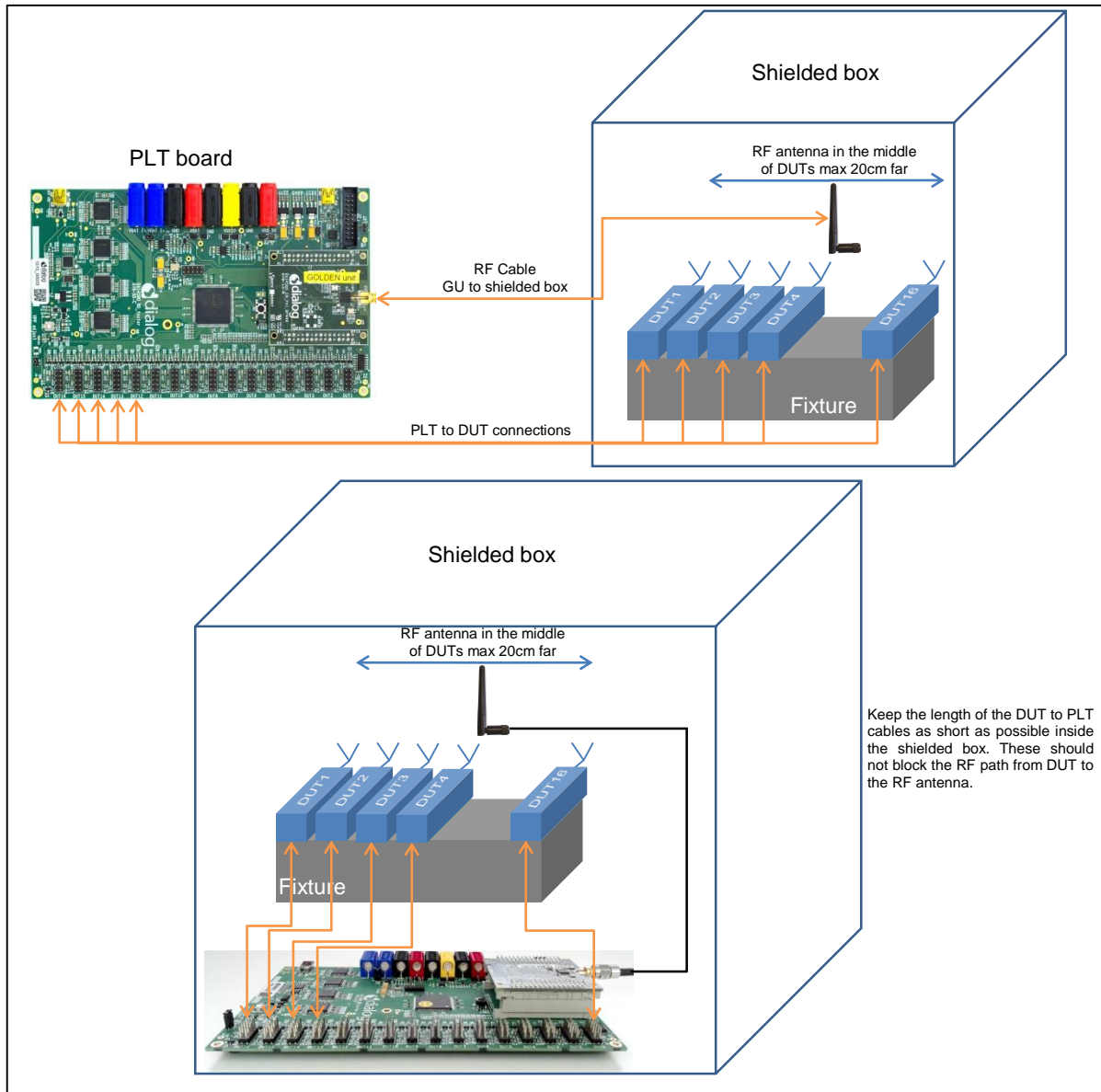

Figure 164: Setup diagram

Table 116: Calibration Setup

Item	Description
PLT board	The PLT board could either be outside or inside the shielded box, as shown in Figure 164 , depending on the fixture setup.
DUTs	The DUT antennas should point the RF antenna.
PLT to DUT connections	The PLT to DUT cable connections should be as short as possible. Also, the cables should not block the RF path from DUT to the RF antenna.
Shielded box	The shielded box must be big enough to fit the PCBA and the fixture and the PLT if it is inside.

DA1458x/DA1468x Production Line Tool

Item	Description
RF cable - PLT to shielded box.	<p>This type of cable must have good shielded effectiveness and low attenuation. Its shielded effectiveness must be >60dB. Check Table 115 for the best proposals. If multiple production lines are used the shielding of this RF cable is crucial not to have disturbance from other PLTs that are close. However, if other PLTs are far away (>3m) other cables could also be used.</p> <ul style="list-style-type: none"> ● FLEXIBLE CABLE 2.6/50 S (RG316 - KX22A) P/N: C291 170 007
RF cable – Shielded box to RF antenna (optional).	<p>Due to the close distance between the DUT antennas and the RF antenna cable, the shielding of this cable should be very good. It must be at least 60dB. Check Table 115 for proposals.</p> <p>This cable can be optional. The RF antenna could be mounted directly to the SMA RF connector inside the shielded box. In that case the fixture and the DUTs should be placed appropriately (less than 20cm).</p>
RF antenna	<p>The RF antenna can be any good Wi-Fi antenna that operates at 2.5GHz. It should be placed in a vertical position as shown in Figure 164. The distance to the DUTs should not be larger than 20cm. It should be placed in the middle of the DUTs (in front of DUT 8).</p> <p>Bear in mind that the Anritsu MT8852B BLE tester cannot perform TX measurements if the received signal at its antenna is less than -50dBm. Having said that, for a good measurement, the signal reaching its antenna should be more than -40dBm.</p> <p>Therefore the distance and the placement between the DUTs and the RF antenna are very crucial. A lot of trial and errors could be tried out until the optimal antenna position is found.</p> <p>The RF antenna placement should be very stable. After the optimal position is found, it should be fixed into position and not able to move in any way.</p>
DUT fixture	<p>The fixture position should be fixed compared to the RF antenna. The fixture should not move in any way in order to keep the distance between the DUTs and the RF antenna fixed.</p>

DA1458x/DA1468x Production Line Tool

E.3 Procedure

Table 117 describes the steps to be followed in order to calculate the RF path losses for each different DUT position.

Table 117: Procedure steps

#	Step	Description
1	Open the DA1458x_DA1468x_CFG_PLT.exe PLT configuration executable.	User should configure the PLT so only XTAL trim (without OTP burn) and one Golden Unit RF test is enabled.
2	Enable all 16 DUTs	<p>Select the GU COM port and Enumerate the DUT COM port numbers.</p>
3	Enable only the Production tests	<p>Under the General tab, enable only the Production tests and disable the Memory programming.</p>
4	Enable XTAL trim (no OTP burn) and one Golden Unit RF test at middle band at 2440MHz.	<p>RSSI and PER limits do not matter. These should be set to a small value (less than -70dBm) as shown below. Ideally we want the limits to be set to a value that all RF tests PASS.</p>

DA1458x/DA1468x Production Line Tool

#	Step	Description																																																																																															
5	Set all DUT path losses to 0dB.	<p>RF Tests</p> <p>Golden Unit</p> <p>BLE Tester</p> <p>Path losses per DUT</p> <p>Path losses per DUT. Values 0.00 to 40.00dB.</p> <table border="1"> <tr> <td>DUT 1</td><td>0.00</td> <td>DUT 5</td><td>0.00</td> <td>DUT 9</td><td>0.00</td> <td>DUT 13</td><td>0.00</td> </tr> <tr> <td>DUT 2</td><td>0.00</td> <td>DUT 6</td><td>0.00</td> <td>DUT 10</td><td>0.00</td> <td>DUT 14</td><td>0.00</td> </tr> <tr> <td>DUT 3</td><td>0.00</td> <td>DUT 7</td><td>0.00</td> <td>DUT 11</td><td>0.00</td> <td>DUT 15</td><td>0.00</td> </tr> <tr> <td>DUT 4</td><td>0.00</td> <td>DUT 8</td><td>0.00</td> <td>DUT 12</td><td>0.00</td> <td>DUT 16</td><td>0.00</td> </tr> </table>	DUT 1	0.00	DUT 5	0.00	DUT 9	0.00	DUT 13	0.00	DUT 2	0.00	DUT 6	0.00	DUT 10	0.00	DUT 14	0.00	DUT 3	0.00	DUT 7	0.00	DUT 11	0.00	DUT 15	0.00	DUT 4	0.00	DUT 8	0.00	DUT 12	0.00	DUT 16	0.00																																																															
DUT 1	0.00	DUT 5	0.00	DUT 9	0.00	DUT 13	0.00																																																																																										
DUT 2	0.00	DUT 6	0.00	DUT 10	0.00	DUT 14	0.00																																																																																										
DUT 3	0.00	DUT 7	0.00	DUT 11	0.00	DUT 15	0.00																																																																																										
DUT 4	0.00	DUT 8	0.00	DUT 12	0.00	DUT 16	0.00																																																																																										
6	Backup CSV log file.	<p>Go to DA1458x_DA1468x_PLT_v_4.x\executables\logs and back up the today's CSV file. For example if the today's CSV file is Test_station_1_20180306_csv_results.csv rename it to Test_station_1_20180306_csv_results_BackUp.csv.</p> <p>Doing so, a new CSV file will be created at the next PLT test run.</p>																																																																																															
7	Place the 1 st PCBA	Place the 1 st PCBA into the fixture inside the shielded box.																																																																																															
8	Open DA1458x_DA1468x_GUI_PLT.exe	<p>File Edit Run</p> <p>Start BD address 80:80:80:00:00:0A</p> <p>Next BD address 80:80:80:00:00:0A</p> <p>End BD address 00:00:00:00:00:00</p> <p>Statistics</p> <p>Pass: 1</p> <p>Fail: 2</p> <p>Total: 0</p> <p>Left: 0</p> <p>Runs: 1</p> <p>IC DA14580</p> <p><input type="checkbox"/> COM Enum</p> <p><input type="checkbox"/> GU Check</p> <p><input type="checkbox"/> VBAT/UART</p> <p><input type="checkbox"/> UART check</p> <table border="1"> <thead> <tr> <th>DUT</th> <th>BD Address</th> <th>Code</th> <th>Status</th> <th>Result</th> </tr> </thead> <tbody> <tr><td>1</td><td>80:80:80:00:00:0A</td><td></td><td></td><td></td></tr> <tr><td>2</td><td>80:80:80:00:00:0B</td><td></td><td></td><td></td></tr> <tr><td>3</td><td>80:80:80:00:00:0C</td><td></td><td></td><td></td></tr> <tr><td>4</td><td>80:80:80:00:00:0A</td><td></td><td></td><td></td></tr> <tr><td>5</td><td>00:00:00:00:00:07</td><td></td><td></td><td></td></tr> <tr><td>6</td><td>00:00:00:00:00:08</td><td></td><td></td><td></td></tr> <tr><td>7</td><td>00:00:00:00:00:09</td><td></td><td></td><td></td></tr> <tr><td>8</td><td>00:00:00:00:00:0A</td><td></td><td></td><td></td></tr> <tr><td>9</td><td>00:00:00:00:00:0B</td><td></td><td></td><td></td></tr> <tr><td>10</td><td>00:00:00:00:00:0C</td><td></td><td></td><td></td></tr> <tr><td>11</td><td>00:00:00:00:00:0D</td><td></td><td></td><td></td></tr> <tr><td>12</td><td>00:00:00:00:00:0E</td><td></td><td></td><td></td></tr> <tr><td>13</td><td>00:00:00:00:00:0F</td><td></td><td></td><td></td></tr> <tr><td>14</td><td>00:00:00:00:00:10</td><td></td><td></td><td></td></tr> <tr><td>15</td><td>00:00:00:00:00:11</td><td></td><td></td><td></td></tr> <tr><td>16</td><td>00:00:00:00:00:12</td><td></td><td></td><td></td></tr> </tbody> </table> <table border="1"> <thead> <tr> <th>GU</th> <th>COM Port</th> <th>Code</th> <th>Status</th> <th>Result</th> </tr> </thead> <tbody> <tr> <td></td> <td>COM14</td> <td></td> <td></td> <td></td> </tr> </tbody> </table> <p>BLE Tester Temp Ammeter Voltmeter</p> <p>START</p> <p>C:\DA1458x_DA1468x_PLT_v_4.x\executables\params\params.xml Retest failed: Disabled Test Time: 00:00:000</p>	DUT	BD Address	Code	Status	Result	1	80:80:80:00:00:0A				2	80:80:80:00:00:0B				3	80:80:80:00:00:0C				4	80:80:80:00:00:0A				5	00:00:00:00:00:07				6	00:00:00:00:00:08				7	00:00:00:00:00:09				8	00:00:00:00:00:0A				9	00:00:00:00:00:0B				10	00:00:00:00:00:0C				11	00:00:00:00:00:0D				12	00:00:00:00:00:0E				13	00:00:00:00:00:0F				14	00:00:00:00:00:10				15	00:00:00:00:00:11				16	00:00:00:00:00:12				GU	COM Port	Code	Status	Result		COM14			
DUT	BD Address	Code	Status	Result																																																																																													
1	80:80:80:00:00:0A																																																																																																
2	80:80:80:00:00:0B																																																																																																
3	80:80:80:00:00:0C																																																																																																
4	80:80:80:00:00:0A																																																																																																
5	00:00:00:00:00:07																																																																																																
6	00:00:00:00:00:08																																																																																																
7	00:00:00:00:00:09																																																																																																
8	00:00:00:00:00:0A																																																																																																
9	00:00:00:00:00:0B																																																																																																
10	00:00:00:00:00:0C																																																																																																
11	00:00:00:00:00:0D																																																																																																
12	00:00:00:00:00:0E																																																																																																
13	00:00:00:00:00:0F																																																																																																
14	00:00:00:00:00:10																																																																																																
15	00:00:00:00:00:11																																																																																																
16	00:00:00:00:00:12																																																																																																
GU	COM Port	Code	Status	Result																																																																																													
	COM14																																																																																																

DA1458x/DA1468x Production Line Tool

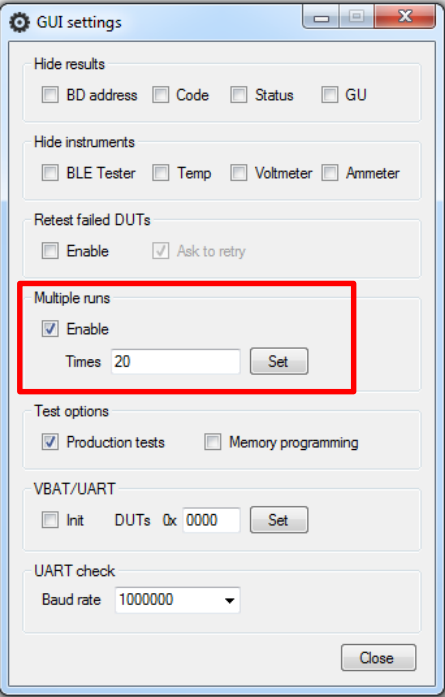
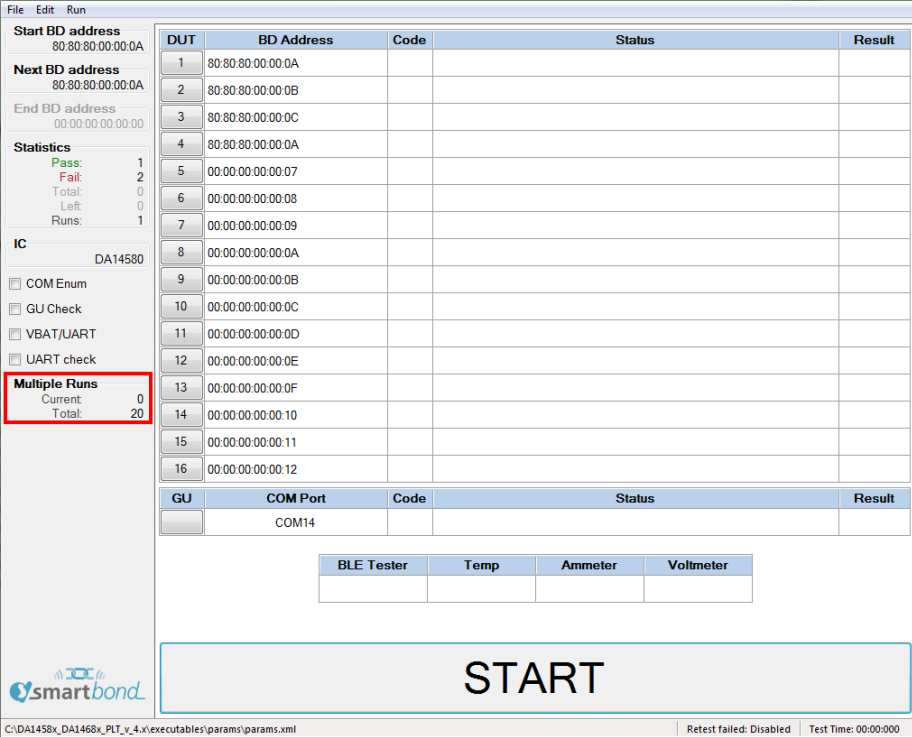
#	Step	Description
9	Go to Edit->Settings	<p>Select the Multiple runs. Set the Times to 20. Press Set and Close.</p> 
10	In the DA1458x_DA1468x_GUI_PLT.exe the Multiple Runs should be shown on the left panel	
11	Press START	Press START and wait for the 20 tests to be performed.
12	Backup CSV log file	<p>Go to DA1458x_DA1468x_PLT_v_4.2.3.198\executables\logs and back up the CSV file for the 1st PCBA. For example if the today's CSV file is Test_station_1_20180306_csv_results.csv rename it to Test_station_1_20180306_csv_results_PCBA_1.csv.</p>

DA1458x/DA1468x Production Line Tool

#	Step	Description																																																																																																																																																																																																																																																																																																																													
13	Place the 2 nd PCBA	Place the 2 nd PCBA into the fixture inside the shielded box.																																																																																																																																																																																																																																																																																																																													
14	Repeat steps	Repeat the procedure from step 9 to step 13 for all 10 PCBAs.																																																																																																																																																																																																																																																																																																																													
15	Check CSV results	<p>At the end, 10 CSV logs files should exist. E.g. Test_station_1_20180306_csv_results_PCBA_1.csv. Test_station_1_20180306_csv_results_PCBA_2.csv. ... Test_station_1_20180306_csv_results_PCBA_10.csv.</p> <p>Each CSV file should have 16 DUTs * 20 Tests = 320 lines + 1 CSV header = 321 lines. Example:</p> <table border="1"> <thead> <tr> <th></th> <th>A</th> <th>B</th> <th>C</th> <th>D</th> <th>E</th> <th>F</th> <th>G</th> <th>H</th> <th>I</th> <th>J</th> <th>K</th> <th>L</th> <th>M</th> <th>N</th> <th>O</th> </tr> </thead> <tbody> <tr> <td>1</td> <td>Start time</td> <td>End time</td> <td>DUT</td> <td>BD</td> <td>address</td> <td>Overall</td> <td>COM</td> <td>FW</td> <td>doi</td> <td>FW</td> <td>path</td> <td>1</td> <td>FW</td> <td>ve</td> <td>FW</td> <td>versio</td> <td>XTAL</td> <td>tri</td> <td>XTAL</td> <td>t</td> <td>GU</td> <td>RX</td> <td>GU</td> <td>RX</td> <td>RSS</td> <td>GU</td> <td>RX</td> <td>F</td> </tr> <tr> <td>2</td> <td>11:20:33</td> <td>11:20:47</td> <td>1</td> <td>00:00:00:0</td> <td>PASS</td> <td>20</td> <td>PASS</td> <td>C:\Users\tr</td> <td>PASS</td> <td>v_5.0.4</td> <td>PI</td> <td>PASS</td> <td>1172</td> <td>PASS</td> <td>-28.5</td> <td>0</td> </tr> <tr> <td>3</td> <td>11:20:33</td> <td>11:20:47</td> <td>2</td> <td>00:00:00:0</td> <td>PASS</td> <td>12</td> <td>PASS</td> <td>C:\Users\tr</td> <td>PASS</td> <td>v_5.0.4</td> <td>PI</td> <td>PASS</td> <td>1207</td> <td>PASS</td> <td>-26.61</td> <td>0</td> </tr> <tr> <td>4</td> <td>11:20:33</td> <td>11:20:47</td> <td>3</td> <td>00:00:00:0</td> <td>PASS</td> <td>18</td> <td>PASS</td> <td>C:\Users\tr</td> <td>PASS</td> <td>v_5.0.4</td> <td>PI</td> <td>PASS</td> <td>1272</td> <td>PASS</td> <td>-26.61</td> <td>0</td> </tr> <tr> <td>5</td> <td>11:20:33</td> <td>11:20:47</td> <td>4</td> <td>00:00:00:0</td> <td>PASS</td> <td>13</td> <td>PASS</td> <td>C:\Users\tr</td> <td>PASS</td> <td>v_5.0.4</td> <td>PI</td> <td>PASS</td> <td>1222</td> <td>PASS</td> <td>-28.5</td> <td>0</td> </tr> <tr> <td>6</td> <td>11:20:33</td> <td>11:20:47</td> <td>5</td> <td>00:00:00:0</td> <td>PASS</td> <td>11</td> <td>PASS</td> <td>C:\Users\tr</td> <td>PASS</td> <td>v_5.0.4</td> <td>PI</td> <td>PASS</td> <td>1181</td> <td>PASS</td> <td>-26.13</td> <td>0</td> </tr> <tr> <td>7</td> <td>11:20:33</td> <td>11:20:47</td> <td>6</td> <td>00:00:00:0</td> <td>PASS</td> <td>10</td> <td>PASS</td> <td>C:\Users\tr</td> <td>PASS</td> <td>v_5.0.4</td> <td>PI</td> <td>PASS</td> <td>1218</td> <td>PASS</td> <td>-22.34</td> <td>0</td> </tr> <tr> <td>8</td> <td>11:20:33</td> <td>11:20:47</td> <td>7</td> <td>00:00:00:0</td> <td>PASS</td> <td>9</td> <td>PASS</td> <td>C:\Users\tr</td> <td>PASS</td> <td>v_5.0.4</td> <td>PI</td> <td>PASS</td> <td>1237</td> <td>PASS</td> <td>-28.98</td> <td>0</td> </tr> <tr> <td>9</td> <td>11:20:33</td> <td>11:20:47</td> <td>8</td> <td>00:00:00:0</td> <td>PASS</td> <td>19</td> <td>PASS</td> <td>C:\Users\tr</td> <td>PASS</td> <td>v_5.0.4</td> <td>PI</td> <td>PASS</td> <td>1180</td> <td>PASS</td> <td>-38.93</td> <td>0</td> </tr> <tr> <td>10</td> <td>11:20:33</td> <td>11:20:47</td> <td>9</td> <td>00:00:00:0</td> <td>PASS</td> <td>14</td> <td>PASS</td> <td>C:\Users\tr</td> <td>PASS</td> <td>v_5.0.4</td> <td>PI</td> <td>PASS</td> <td>1207</td> <td>PASS</td> <td>-27.08</td> <td>0</td> </tr> <tr> <td>11</td> <td>11:20:33</td> <td>11:20:47</td> <td>10</td> <td>00:00:00:0</td> <td>PASS</td> <td>15</td> <td>PASS</td> <td>C:\Users\tr</td> <td>PASS</td> <td>v_5.0.4</td> <td>PI</td> <td>PASS</td> <td>1244</td> <td>PASS</td> <td>-36.09</td> <td>0</td> </tr> <tr> <td>12</td> <td>11:20:33</td> <td>11:20:47</td> <td>11</td> <td>00:00:00:0</td> <td>PASS</td> <td>16</td> <td>PASS</td> <td>C:\Users\tr</td> <td>PASS</td> <td>v_5.0.4</td> <td>PI</td> <td>PASS</td> <td>1180</td> <td>PASS</td> <td>-34.19</td> <td>0</td> </tr> <tr> <td>13</td> <td>11:20:33</td> <td>11:20:47</td> <td>12</td> <td>00:00:00:0</td> <td>PASS</td> <td>17</td> <td>PASS</td> <td>C:\Users\tr</td> <td>PASS</td> <td>v_5.0.4</td> <td>PI</td> <td>PASS</td> <td>1168</td> <td>PASS</td> <td>-27.08</td> <td>0</td> </tr> <tr> <td>14</td> <td>11:20:33</td> <td>11:20:47</td> <td>13</td> <td>00:00:00:0</td> <td>PASS</td> <td>5</td> <td>PASS</td> <td>C:\Users\tr</td> <td>PASS</td> <td>v_5.0.4</td> <td>PI</td> <td>PASS</td> <td>1255</td> <td>PASS</td> <td>-32.29</td> <td>0</td> </tr> <tr> <td>15</td> <td>11:20:33</td> <td>11:20:47</td> <td>14</td> <td>00:00:00:0</td> <td>PASS</td> <td>6</td> <td>PASS</td> <td>C:\Users\tr</td> <td>PASS</td> <td>v_5.0.4</td> <td>PI</td> <td>PASS</td> <td>1247</td> <td>PASS</td> <td>-23.76</td> <td>0</td> </tr> <tr> <td>16</td> <td>11:20:33</td> <td>11:20:47</td> <td>15</td> <td>00:00:00:0</td> <td>PASS</td> <td>7</td> <td>PASS</td> <td>C:\Users\tr</td> <td>PASS</td> <td>v_5.0.4</td> <td>PI</td> <td>PASS</td> <td>1180</td> <td>PASS</td> <td>-24.71</td> <td>0</td> </tr> <tr> <td>17</td> <td>11:20:33</td> <td>11:20:47</td> <td>16</td> <td>00:00:00:0</td> <td>PASS</td> <td>8</td> <td>PASS</td> <td>C:\Users\tr</td> <td>PASS</td> <td>v_5.0.4</td> <td>PI</td> <td>PASS</td> <td>1247</td> <td>PASS</td> <td>-28.98</td> <td>0</td> </tr> </tbody> </table>		A	B	C	D	E	F	G	H	I	J	K	L	M	N	O	1	Start time	End time	DUT	BD	address	Overall	COM	FW	doi	FW	path	1	FW	ve	FW	versio	XTAL	tri	XTAL	t	GU	RX	GU	RX	RSS	GU	RX	F	2	11:20:33	11:20:47	1	00:00:00:0	PASS	20	PASS	C:\Users\tr	PASS	v_5.0.4	PI	PASS	1172	PASS	-28.5	0	3	11:20:33	11:20:47	2	00:00:00:0	PASS	12	PASS	C:\Users\tr	PASS	v_5.0.4	PI	PASS	1207	PASS	-26.61	0	4	11:20:33	11:20:47	3	00:00:00:0	PASS	18	PASS	C:\Users\tr	PASS	v_5.0.4	PI	PASS	1272	PASS	-26.61	0	5	11:20:33	11:20:47	4	00:00:00:0	PASS	13	PASS	C:\Users\tr	PASS	v_5.0.4	PI	PASS	1222	PASS	-28.5	0	6	11:20:33	11:20:47	5	00:00:00:0	PASS	11	PASS	C:\Users\tr	PASS	v_5.0.4	PI	PASS	1181	PASS	-26.13	0	7	11:20:33	11:20:47	6	00:00:00:0	PASS	10	PASS	C:\Users\tr	PASS	v_5.0.4	PI	PASS	1218	PASS	-22.34	0	8	11:20:33	11:20:47	7	00:00:00:0	PASS	9	PASS	C:\Users\tr	PASS	v_5.0.4	PI	PASS	1237	PASS	-28.98	0	9	11:20:33	11:20:47	8	00:00:00:0	PASS	19	PASS	C:\Users\tr	PASS	v_5.0.4	PI	PASS	1180	PASS	-38.93	0	10	11:20:33	11:20:47	9	00:00:00:0	PASS	14	PASS	C:\Users\tr	PASS	v_5.0.4	PI	PASS	1207	PASS	-27.08	0	11	11:20:33	11:20:47	10	00:00:00:0	PASS	15	PASS	C:\Users\tr	PASS	v_5.0.4	PI	PASS	1244	PASS	-36.09	0	12	11:20:33	11:20:47	11	00:00:00:0	PASS	16	PASS	C:\Users\tr	PASS	v_5.0.4	PI	PASS	1180	PASS	-34.19	0	13	11:20:33	11:20:47	12	00:00:00:0	PASS	17	PASS	C:\Users\tr	PASS	v_5.0.4	PI	PASS	1168	PASS	-27.08	0	14	11:20:33	11:20:47	13	00:00:00:0	PASS	5	PASS	C:\Users\tr	PASS	v_5.0.4	PI	PASS	1255	PASS	-32.29	0	15	11:20:33	11:20:47	14	00:00:00:0	PASS	6	PASS	C:\Users\tr	PASS	v_5.0.4	PI	PASS	1247	PASS	-23.76	0	16	11:20:33	11:20:47	15	00:00:00:0	PASS	7	PASS	C:\Users\tr	PASS	v_5.0.4	PI	PASS	1180	PASS	-24.71	0	17	11:20:33	11:20:47	16	00:00:00:0	PASS	8	PASS	C:\Users\tr	PASS	v_5.0.4	PI	PASS	1247	PASS	-28.98	0
	A	B	C	D	E	F	G	H	I	J	K	L	M	N	O																																																																																																																																																																																																																																																																																																																
1	Start time	End time	DUT	BD	address	Overall	COM	FW	doi	FW	path	1	FW	ve	FW	versio	XTAL	tri	XTAL	t	GU	RX	GU	RX	RSS	GU	RX	F																																																																																																																																																																																																																																																																																																			
2	11:20:33	11:20:47	1	00:00:00:0	PASS	20	PASS	C:\Users\tr	PASS	v_5.0.4	PI	PASS	1172	PASS	-28.5	0																																																																																																																																																																																																																																																																																																															
3	11:20:33	11:20:47	2	00:00:00:0	PASS	12	PASS	C:\Users\tr	PASS	v_5.0.4	PI	PASS	1207	PASS	-26.61	0																																																																																																																																																																																																																																																																																																															
4	11:20:33	11:20:47	3	00:00:00:0	PASS	18	PASS	C:\Users\tr	PASS	v_5.0.4	PI	PASS	1272	PASS	-26.61	0																																																																																																																																																																																																																																																																																																															
5	11:20:33	11:20:47	4	00:00:00:0	PASS	13	PASS	C:\Users\tr	PASS	v_5.0.4	PI	PASS	1222	PASS	-28.5	0																																																																																																																																																																																																																																																																																																															
6	11:20:33	11:20:47	5	00:00:00:0	PASS	11	PASS	C:\Users\tr	PASS	v_5.0.4	PI	PASS	1181	PASS	-26.13	0																																																																																																																																																																																																																																																																																																															
7	11:20:33	11:20:47	6	00:00:00:0	PASS	10	PASS	C:\Users\tr	PASS	v_5.0.4	PI	PASS	1218	PASS	-22.34	0																																																																																																																																																																																																																																																																																																															
8	11:20:33	11:20:47	7	00:00:00:0	PASS	9	PASS	C:\Users\tr	PASS	v_5.0.4	PI	PASS	1237	PASS	-28.98	0																																																																																																																																																																																																																																																																																																															
9	11:20:33	11:20:47	8	00:00:00:0	PASS	19	PASS	C:\Users\tr	PASS	v_5.0.4	PI	PASS	1180	PASS	-38.93	0																																																																																																																																																																																																																																																																																																															
10	11:20:33	11:20:47	9	00:00:00:0	PASS	14	PASS	C:\Users\tr	PASS	v_5.0.4	PI	PASS	1207	PASS	-27.08	0																																																																																																																																																																																																																																																																																																															
11	11:20:33	11:20:47	10	00:00:00:0	PASS	15	PASS	C:\Users\tr	PASS	v_5.0.4	PI	PASS	1244	PASS	-36.09	0																																																																																																																																																																																																																																																																																																															
12	11:20:33	11:20:47	11	00:00:00:0	PASS	16	PASS	C:\Users\tr	PASS	v_5.0.4	PI	PASS	1180	PASS	-34.19	0																																																																																																																																																																																																																																																																																																															
13	11:20:33	11:20:47	12	00:00:00:0	PASS	17	PASS	C:\Users\tr	PASS	v_5.0.4	PI	PASS	1168	PASS	-27.08	0																																																																																																																																																																																																																																																																																																															
14	11:20:33	11:20:47	13	00:00:00:0	PASS	5	PASS	C:\Users\tr	PASS	v_5.0.4	PI	PASS	1255	PASS	-32.29	0																																																																																																																																																																																																																																																																																																															
15	11:20:33	11:20:47	14	00:00:00:0	PASS	6	PASS	C:\Users\tr	PASS	v_5.0.4	PI	PASS	1247	PASS	-23.76	0																																																																																																																																																																																																																																																																																																															
16	11:20:33	11:20:47	15	00:00:00:0	PASS	7	PASS	C:\Users\tr	PASS	v_5.0.4	PI	PASS	1180	PASS	-24.71	0																																																																																																																																																																																																																																																																																																															
17	11:20:33	11:20:47	16	00:00:00:0	PASS	8	PASS	C:\Users\tr	PASS	v_5.0.4	PI	PASS	1247	PASS	-28.98	0																																																																																																																																																																																																																																																																																																															
16	Get the average for each DUT in each CSV file	<p>In each CSV file, get the average GU RX RSSI value for each DUT. Apply the following formulas to each of the 10 CSV files.</p> <table border="1"> <thead> <tr> <th>DUT #</th> <th>Formula</th> <th>Example Result</th> </tr> </thead> <tbody> <tr> <td>DUT 1</td> <td>=SUMIF(\$C\$2:\$C\$321,1,\$N\$2:\$N\$321)/20</td> <td>-28.5015</td> </tr> <tr> <td>DUT 2</td> <td>=SUMIF(\$C\$2:\$C\$321,2,\$N\$2:\$N\$321)/20</td> <td>-26.609</td> </tr> <tr> <td>DUT 3</td> <td>=SUMIF(\$C\$2:\$C\$321,3,\$N\$2:\$N\$321)/20</td> <td>-26.8685</td> </tr> <tr> <td>DUT 4</td> <td>=SUMIF(\$C\$2:\$C\$321,4,\$N\$2:\$N\$321)/20</td> <td>-28.406</td> </tr> <tr> <td>DUT 5</td> <td>=SUMIF(\$C\$2:\$C\$321,5,\$N\$2:\$N\$321)/20</td> <td>-26.346</td> </tr> <tr> <td>DUT 6</td> <td>=SUMIF(\$C\$2:\$C\$321,6,\$N\$2:\$N\$321)/20</td> <td>-22.5515</td> </tr> <tr> <td>DUT 7</td> <td>=SUMIF(\$C\$2:\$C\$321,7,\$N\$2:\$N\$321)/20</td> <td>-28.98</td> </tr> <tr> <td>DUT 8</td> <td>=SUMIF(\$C\$2:\$C\$321,8,\$N\$2:\$N\$321)/20</td> <td>-39.283</td> </tr> <tr> <td>DUT 9</td> <td>=SUMIF(\$C\$2:\$C\$321,9,\$N\$2:\$N\$321)/20</td> <td>-27.08</td> </tr> <tr> <td>DUT 10</td> <td>=SUMIF(\$C\$2:\$C\$321,10,\$N\$2:\$N\$321)/20</td> <td>-36.607</td> </tr> <tr> <td>DUT 11</td> <td>=SUMIF(\$C\$2:\$C\$321,11,\$N\$2:\$N\$321)/20</td> <td>-34.19</td> </tr> <tr> <td>DUT 12</td> <td>=SUMIF(\$C\$2:\$C\$321,12,\$N\$2:\$N\$321)/20</td> <td>-26.7745</td> </tr> <tr> <td>DUT 13</td> <td>=SUMIF(\$C\$2:\$C\$321,13,\$N\$2:\$N\$321)/20</td> <td>-32.0095</td> </tr> <tr> <td>DUT 14</td> <td>=SUMIF(\$C\$2:\$C\$321,14,\$N\$2:\$N\$321)/20</td> <td>-23.784</td> </tr> <tr> <td>DUT 15</td> <td>=SUMIF(\$C\$2:\$C\$321,15,\$N\$2:\$N\$321)/20</td> <td>-24.71</td> </tr> <tr> <td>DUT 16</td> <td>=SUMIF(\$C\$2:\$C\$321,16,\$N\$2:\$N\$321)/20</td> <td>-29.168</td> </tr> </tbody> </table>	DUT #	Formula	Example Result	DUT 1	=SUMIF(\$C\$2:\$C\$321,1,\$N\$2:\$N\$321)/20	-28.5015	DUT 2	=SUMIF(\$C\$2:\$C\$321,2,\$N\$2:\$N\$321)/20	-26.609	DUT 3	=SUMIF(\$C\$2:\$C\$321,3,\$N\$2:\$N\$321)/20	-26.8685	DUT 4	=SUMIF(\$C\$2:\$C\$321,4,\$N\$2:\$N\$321)/20	-28.406	DUT 5	=SUMIF(\$C\$2:\$C\$321,5,\$N\$2:\$N\$321)/20	-26.346	DUT 6	=SUMIF(\$C\$2:\$C\$321,6,\$N\$2:\$N\$321)/20	-22.5515	DUT 7	=SUMIF(\$C\$2:\$C\$321,7,\$N\$2:\$N\$321)/20	-28.98	DUT 8	=SUMIF(\$C\$2:\$C\$321,8,\$N\$2:\$N\$321)/20	-39.283	DUT 9	=SUMIF(\$C\$2:\$C\$321,9,\$N\$2:\$N\$321)/20	-27.08	DUT 10	=SUMIF(\$C\$2:\$C\$321,10,\$N\$2:\$N\$321)/20	-36.607	DUT 11	=SUMIF(\$C\$2:\$C\$321,11,\$N\$2:\$N\$321)/20	-34.19	DUT 12	=SUMIF(\$C\$2:\$C\$321,12,\$N\$2:\$N\$321)/20	-26.7745	DUT 13	=SUMIF(\$C\$2:\$C\$321,13,\$N\$2:\$N\$321)/20	-32.0095	DUT 14	=SUMIF(\$C\$2:\$C\$321,14,\$N\$2:\$N\$321)/20	-23.784	DUT 15	=SUMIF(\$C\$2:\$C\$321,15,\$N\$2:\$N\$321)/20	-24.71	DUT 16	=SUMIF(\$C\$2:\$C\$321,16,\$N\$2:\$N\$321)/20	-29.168																																																																																																																																																																																																																																																																										
DUT #	Formula	Example Result																																																																																																																																																																																																																																																																																																																													
DUT 1	=SUMIF(\$C\$2:\$C\$321,1,\$N\$2:\$N\$321)/20	-28.5015																																																																																																																																																																																																																																																																																																																													
DUT 2	=SUMIF(\$C\$2:\$C\$321,2,\$N\$2:\$N\$321)/20	-26.609																																																																																																																																																																																																																																																																																																																													
DUT 3	=SUMIF(\$C\$2:\$C\$321,3,\$N\$2:\$N\$321)/20	-26.8685																																																																																																																																																																																																																																																																																																																													
DUT 4	=SUMIF(\$C\$2:\$C\$321,4,\$N\$2:\$N\$321)/20	-28.406																																																																																																																																																																																																																																																																																																																													
DUT 5	=SUMIF(\$C\$2:\$C\$321,5,\$N\$2:\$N\$321)/20	-26.346																																																																																																																																																																																																																																																																																																																													
DUT 6	=SUMIF(\$C\$2:\$C\$321,6,\$N\$2:\$N\$321)/20	-22.5515																																																																																																																																																																																																																																																																																																																													
DUT 7	=SUMIF(\$C\$2:\$C\$321,7,\$N\$2:\$N\$321)/20	-28.98																																																																																																																																																																																																																																																																																																																													
DUT 8	=SUMIF(\$C\$2:\$C\$321,8,\$N\$2:\$N\$321)/20	-39.283																																																																																																																																																																																																																																																																																																																													
DUT 9	=SUMIF(\$C\$2:\$C\$321,9,\$N\$2:\$N\$321)/20	-27.08																																																																																																																																																																																																																																																																																																																													
DUT 10	=SUMIF(\$C\$2:\$C\$321,10,\$N\$2:\$N\$321)/20	-36.607																																																																																																																																																																																																																																																																																																																													
DUT 11	=SUMIF(\$C\$2:\$C\$321,11,\$N\$2:\$N\$321)/20	-34.19																																																																																																																																																																																																																																																																																																																													
DUT 12	=SUMIF(\$C\$2:\$C\$321,12,\$N\$2:\$N\$321)/20	-26.7745																																																																																																																																																																																																																																																																																																																													
DUT 13	=SUMIF(\$C\$2:\$C\$321,13,\$N\$2:\$N\$321)/20	-32.0095																																																																																																																																																																																																																																																																																																																													
DUT 14	=SUMIF(\$C\$2:\$C\$321,14,\$N\$2:\$N\$321)/20	-23.784																																																																																																																																																																																																																																																																																																																													
DUT 15	=SUMIF(\$C\$2:\$C\$321,15,\$N\$2:\$N\$321)/20	-24.71																																																																																																																																																																																																																																																																																																																													
DUT 16	=SUMIF(\$C\$2:\$C\$321,16,\$N\$2:\$N\$321)/20	-29.168																																																																																																																																																																																																																																																																																																																													

DA1458x/DA1468x Production Line Tool

#	Step	Description																																																																																																																																																																																											
17	Get all values to a new excel sheet.	<p>Create a new excel sheet. Copy all values created at step 16 from the 10 CSV files to this new excel sheet. An example of all DUT average values from all 10 CSV files is given below. Only 2 decimal digits are shown.</p> <table border="1"> <thead> <tr> <th>DUT</th> <th>PCBA 1</th> <th>PCBA 2</th> <th>PCBA 3</th> <th>PCBA 4</th> <th>PCBA 5</th> <th>PCBA 6</th> <th>PCBA 7</th> <th>PCBA 8</th> <th>PCBA 9</th> <th>PCBA 10</th> </tr> </thead> <tbody> <tr><td>1</td><td>-28.50</td><td>-28.30</td><td>-28.51</td><td>-27.56</td><td>-29.48</td><td>-28.59</td><td>-30.09</td><td>-29.33</td><td>-30.50</td><td>-30.13</td></tr> <tr><td>2</td><td>-26.61</td><td>-26.07</td><td>-27.09</td><td>-26.56</td><td>-27.99</td><td>-27.38</td><td>-28.31</td><td>-27.64</td><td>-28.36</td><td>-28.11</td></tr> <tr><td>3</td><td>-26.87</td><td>-26.71</td><td>-27.65</td><td>-26.71</td><td>-28.64</td><td>-27.84</td><td>-29.14</td><td>-28.43</td><td>-29.54</td><td>-29.14</td></tr> <tr><td>4</td><td>-28.41</td><td>-27.98</td><td>-28.82</td><td>-27.87</td><td>-29.49</td><td>-29.24</td><td>-30.10</td><td>-29.61</td><td>-30.22</td><td>-29.36</td></tr> <tr><td>5</td><td>-26.35</td><td>-25.69</td><td>-26.72</td><td>-26.58</td><td>-26.74</td><td>-26.02</td><td>-27.37</td><td>-26.75</td><td>-27.42</td><td>-27.20</td></tr> <tr><td>6</td><td>-22.55</td><td>-21.60</td><td>-22.68</td><td>-21.81</td><td>-23.32</td><td>-22.33</td><td>-23.82</td><td>-23.77</td><td>-24.45</td><td>-24.19</td></tr> <tr><td>7</td><td>-28.98</td><td>-28.59</td><td>-29.31</td><td>-28.49</td><td>-29.42</td><td>-28.63</td><td>-29.84</td><td>-28.95</td><td>-29.98</td><td>-29.73</td></tr> <tr><td>8</td><td>-39.28</td><td>-39.06</td><td>-39.50</td><td>-38.95</td><td>-39.53</td><td>-39.38</td><td>-40.32</td><td>-40.11</td><td>-40.39</td><td>-39.90</td></tr> <tr><td>9</td><td>-27.08</td><td>-26.64</td><td>-27.68</td><td>-27.07</td><td>-27.76</td><td>-27.28</td><td>-28.40</td><td>-27.51</td><td>-28.89</td><td>-28.75</td></tr> <tr><td>10</td><td>-36.61</td><td>-35.74</td><td>-36.85</td><td>-36.05</td><td>-37.07</td><td>-37.04</td><td>-37.96</td><td>-37.59</td><td>-38.84</td><td>-38.03</td></tr> <tr><td>11</td><td>-34.19</td><td>-33.57</td><td>-35.15</td><td>-34.94</td><td>-36.09</td><td>-35.10</td><td>-36.11</td><td>-35.23</td><td>-36.21</td><td>-35.97</td></tr> <tr><td>12</td><td>-26.77</td><td>-26.51</td><td>-26.90</td><td>-26.65</td><td>-27.33</td><td>-27.11</td><td>-27.40</td><td>-26.67</td><td>-28.03</td><td>-27.26</td></tr> <tr><td>13</td><td>-32.01</td><td>-31.14</td><td>-32.47</td><td>-31.73</td><td>-33.29</td><td>-32.96</td><td>-34.01</td><td>-33.61</td><td>-34.85</td><td>-34.17</td></tr> <tr><td>14</td><td>-23.78</td><td>-23.31</td><td>-24.50</td><td>-23.56</td><td>-24.51</td><td>-24.46</td><td>-24.55</td><td>-23.60</td><td>-25.03</td><td>-24.67</td></tr> <tr><td>15</td><td>-24.71</td><td>-23.89</td><td>-25.39</td><td>-24.82</td><td>-25.46</td><td>-25.37</td><td>-26.24</td><td>-25.42</td><td>-27.09</td><td>-26.94</td></tr> <tr><td>16</td><td>-29.17</td><td>-28.37</td><td>-30.09</td><td>-30.07</td><td>-30.78</td><td>-29.83</td><td>-31.27</td><td>-30.51</td><td>-31.31</td><td>-30.56</td></tr> </tbody> </table>	DUT	PCBA 1	PCBA 2	PCBA 3	PCBA 4	PCBA 5	PCBA 6	PCBA 7	PCBA 8	PCBA 9	PCBA 10	1	-28.50	-28.30	-28.51	-27.56	-29.48	-28.59	-30.09	-29.33	-30.50	-30.13	2	-26.61	-26.07	-27.09	-26.56	-27.99	-27.38	-28.31	-27.64	-28.36	-28.11	3	-26.87	-26.71	-27.65	-26.71	-28.64	-27.84	-29.14	-28.43	-29.54	-29.14	4	-28.41	-27.98	-28.82	-27.87	-29.49	-29.24	-30.10	-29.61	-30.22	-29.36	5	-26.35	-25.69	-26.72	-26.58	-26.74	-26.02	-27.37	-26.75	-27.42	-27.20	6	-22.55	-21.60	-22.68	-21.81	-23.32	-22.33	-23.82	-23.77	-24.45	-24.19	7	-28.98	-28.59	-29.31	-28.49	-29.42	-28.63	-29.84	-28.95	-29.98	-29.73	8	-39.28	-39.06	-39.50	-38.95	-39.53	-39.38	-40.32	-40.11	-40.39	-39.90	9	-27.08	-26.64	-27.68	-27.07	-27.76	-27.28	-28.40	-27.51	-28.89	-28.75	10	-36.61	-35.74	-36.85	-36.05	-37.07	-37.04	-37.96	-37.59	-38.84	-38.03	11	-34.19	-33.57	-35.15	-34.94	-36.09	-35.10	-36.11	-35.23	-36.21	-35.97	12	-26.77	-26.51	-26.90	-26.65	-27.33	-27.11	-27.40	-26.67	-28.03	-27.26	13	-32.01	-31.14	-32.47	-31.73	-33.29	-32.96	-34.01	-33.61	-34.85	-34.17	14	-23.78	-23.31	-24.50	-23.56	-24.51	-24.46	-24.55	-23.60	-25.03	-24.67	15	-24.71	-23.89	-25.39	-24.82	-25.46	-25.37	-26.24	-25.42	-27.09	-26.94	16	-29.17	-28.37	-30.09	-30.07	-30.78	-29.83	-31.27	-30.51	-31.31	-30.56
DUT	PCBA 1	PCBA 2	PCBA 3	PCBA 4	PCBA 5	PCBA 6	PCBA 7	PCBA 8	PCBA 9	PCBA 10																																																																																																																																																																																			
1	-28.50	-28.30	-28.51	-27.56	-29.48	-28.59	-30.09	-29.33	-30.50	-30.13																																																																																																																																																																																			
2	-26.61	-26.07	-27.09	-26.56	-27.99	-27.38	-28.31	-27.64	-28.36	-28.11																																																																																																																																																																																			
3	-26.87	-26.71	-27.65	-26.71	-28.64	-27.84	-29.14	-28.43	-29.54	-29.14																																																																																																																																																																																			
4	-28.41	-27.98	-28.82	-27.87	-29.49	-29.24	-30.10	-29.61	-30.22	-29.36																																																																																																																																																																																			
5	-26.35	-25.69	-26.72	-26.58	-26.74	-26.02	-27.37	-26.75	-27.42	-27.20																																																																																																																																																																																			
6	-22.55	-21.60	-22.68	-21.81	-23.32	-22.33	-23.82	-23.77	-24.45	-24.19																																																																																																																																																																																			
7	-28.98	-28.59	-29.31	-28.49	-29.42	-28.63	-29.84	-28.95	-29.98	-29.73																																																																																																																																																																																			
8	-39.28	-39.06	-39.50	-38.95	-39.53	-39.38	-40.32	-40.11	-40.39	-39.90																																																																																																																																																																																			
9	-27.08	-26.64	-27.68	-27.07	-27.76	-27.28	-28.40	-27.51	-28.89	-28.75																																																																																																																																																																																			
10	-36.61	-35.74	-36.85	-36.05	-37.07	-37.04	-37.96	-37.59	-38.84	-38.03																																																																																																																																																																																			
11	-34.19	-33.57	-35.15	-34.94	-36.09	-35.10	-36.11	-35.23	-36.21	-35.97																																																																																																																																																																																			
12	-26.77	-26.51	-26.90	-26.65	-27.33	-27.11	-27.40	-26.67	-28.03	-27.26																																																																																																																																																																																			
13	-32.01	-31.14	-32.47	-31.73	-33.29	-32.96	-34.01	-33.61	-34.85	-34.17																																																																																																																																																																																			
14	-23.78	-23.31	-24.50	-23.56	-24.51	-24.46	-24.55	-23.60	-25.03	-24.67																																																																																																																																																																																			
15	-24.71	-23.89	-25.39	-24.82	-25.46	-25.37	-26.24	-25.42	-27.09	-26.94																																																																																																																																																																																			
16	-29.17	-28.37	-30.09	-30.07	-30.78	-29.83	-31.27	-30.51	-31.31	-30.56																																																																																																																																																																																			
18	Get the average of each DUT for all PCBAs	<p>Average each DUTs results.</p> <table border="1"> <thead> <tr> <th>DUT</th> <th>=AVERAGE(B1:K1)</th> </tr> </thead> <tbody> <tr><td>DUT 1</td><td>-29.10</td></tr> <tr><td>DUT 2</td><td>-27.41</td></tr> <tr><td>DUT 3</td><td>-28.07</td></tr> <tr><td>DUT 4</td><td>-29.11</td></tr> <tr><td>DUT 5</td><td>-26.68</td></tr> <tr><td>DUT 6</td><td>-23.05</td></tr> <tr><td>DUT 7</td><td>-29.19</td></tr> <tr><td>DUT 8</td><td>-39.64</td></tr> <tr><td>DUT 9</td><td>-27.71</td></tr> <tr><td>DUT 10</td><td>-37.18</td></tr> <tr><td>DUT 11</td><td>-35.26</td></tr> <tr><td>DUT 12</td><td>-27.06</td></tr> <tr><td>DUT 13</td><td>-33.02</td></tr> <tr><td>DUT 14</td><td>-24.20</td></tr> <tr><td>DUT 15</td><td>-25.53</td></tr> <tr><td>DUT 16</td><td>-30.20</td></tr> </tbody> </table>	DUT	=AVERAGE(B1:K1)	DUT 1	-29.10	DUT 2	-27.41	DUT 3	-28.07	DUT 4	-29.11	DUT 5	-26.68	DUT 6	-23.05	DUT 7	-29.19	DUT 8	-39.64	DUT 9	-27.71	DUT 10	-37.18	DUT 11	-35.26	DUT 12	-27.06	DUT 13	-33.02	DUT 14	-24.20	DUT 15	-25.53	DUT 16	-30.20																																																																																																																																																									
DUT	=AVERAGE(B1:K1)																																																																																																																																																																																												
DUT 1	-29.10																																																																																																																																																																																												
DUT 2	-27.41																																																																																																																																																																																												
DUT 3	-28.07																																																																																																																																																																																												
DUT 4	-29.11																																																																																																																																																																																												
DUT 5	-26.68																																																																																																																																																																																												
DUT 6	-23.05																																																																																																																																																																																												
DUT 7	-29.19																																																																																																																																																																																												
DUT 8	-39.64																																																																																																																																																																																												
DUT 9	-27.71																																																																																																																																																																																												
DUT 10	-37.18																																																																																																																																																																																												
DUT 11	-35.26																																																																																																																																																																																												
DUT 12	-27.06																																																																																																																																																																																												
DUT 13	-33.02																																																																																																																																																																																												
DUT 14	-24.20																																																																																																																																																																																												
DUT 15	-25.53																																																																																																																																																																																												
DUT 16	-30.20																																																																																																																																																																																												

DA1458x/DA1468x Production Line Tool

#	Step	Description																																																			
19	Calculate the RF path loss	<p>To calibrate the RF result to -10dBm we should apply the formula shown in the third column below.</p> <table border="1"> <thead> <tr> <th>DUT</th> <th>=AVERAGE(B1:K1) Row L</th> <th>Path Loss =-10-L1</th> </tr> </thead> <tbody> <tr><td>DUT 1</td><td>-29.10</td><td>19.10</td></tr> <tr><td>DUT 2</td><td>-27.41</td><td>17.41</td></tr> <tr><td>DUT 3</td><td>-28.07</td><td>18.07</td></tr> <tr><td>DUT 4</td><td>-29.11</td><td>19.11</td></tr> <tr><td>DUT 5</td><td>-26.68</td><td>16.68</td></tr> <tr><td>DUT 6</td><td>-23.05</td><td>13.05</td></tr> <tr><td>DUT 7</td><td>-29.19</td><td>19.19</td></tr> <tr><td>DUT 8</td><td>-39.64</td><td>29.64</td></tr> <tr><td>DUT 9</td><td>-27.71</td><td>17.71</td></tr> <tr><td>DUT 10</td><td>-37.18</td><td>27.18</td></tr> <tr><td>DUT 11</td><td>-35.26</td><td>25.26</td></tr> <tr><td>DUT 12</td><td>-27.06</td><td>17.06</td></tr> <tr><td>DUT 13</td><td>-33.02</td><td>23.02</td></tr> <tr><td>DUT 14</td><td>-24.20</td><td>14.20</td></tr> <tr><td>DUT 15</td><td>-25.53</td><td>15.53</td></tr> <tr><td>DUT 16</td><td>-30.20</td><td>20.20</td></tr> </tbody> </table>	DUT	=AVERAGE(B1:K1) Row L	Path Loss =-10-L1	DUT 1	-29.10	19.10	DUT 2	-27.41	17.41	DUT 3	-28.07	18.07	DUT 4	-29.11	19.11	DUT 5	-26.68	16.68	DUT 6	-23.05	13.05	DUT 7	-29.19	19.19	DUT 8	-39.64	29.64	DUT 9	-27.71	17.71	DUT 10	-37.18	27.18	DUT 11	-35.26	25.26	DUT 12	-27.06	17.06	DUT 13	-33.02	23.02	DUT 14	-24.20	14.20	DUT 15	-25.53	15.53	DUT 16	-30.20	20.20
DUT	=AVERAGE(B1:K1) Row L	Path Loss =-10-L1																																																			
DUT 1	-29.10	19.10																																																			
DUT 2	-27.41	17.41																																																			
DUT 3	-28.07	18.07																																																			
DUT 4	-29.11	19.11																																																			
DUT 5	-26.68	16.68																																																			
DUT 6	-23.05	13.05																																																			
DUT 7	-29.19	19.19																																																			
DUT 8	-39.64	29.64																																																			
DUT 9	-27.71	17.71																																																			
DUT 10	-37.18	27.18																																																			
DUT 11	-35.26	25.26																																																			
DUT 12	-27.06	17.06																																																			
DUT 13	-33.02	23.02																																																			
DUT 14	-24.20	14.20																																																			
DUT 15	-25.53	15.53																																																			
DUT 16	-30.20	20.20																																																			
20	Apply the calculated path losses to the DA1458x_DA1468x_CFG_PLT.exe PLT configuration executable.	<p>The screenshot shows a software window titled "RF Tests" with a tree view on the left containing "Golden Unit", "BLE Tester", and "Path losses per DUT". The main area displays a table of path losses per DUT, with values ranging from 14.2 to 32.02 dB.</p> <table border="1"> <thead> <tr> <th colspan="4">Path losses per DUT. Values 0.00 to 40.00dB.</th> </tr> </thead> <tbody> <tr> <td>DUT 1</td><td>19.1</td> <td>DUT 5</td><td>16.68</td> </tr> <tr> <td>DUT 2</td><td>17.41</td> <td>DUT 6</td><td>13.05</td> </tr> <tr> <td>DUT 3</td><td>18.07</td> <td>DUT 7</td><td>19.19</td> </tr> <tr> <td>DUT 4</td><td>19.11</td> <td>DUT 8</td><td>29.64</td> </tr> <tr> <td>DUT 9</td><td>17.71</td> <td>DUT 11</td><td>25.26</td> </tr> <tr> <td>DUT 10</td><td>27.18</td> <td>DUT 12</td><td>17.06</td> </tr> <tr> <td>DUT 13</td><td>32.02</td> <td>DUT 14</td><td>14.2</td> </tr> <tr> <td>DUT 15</td><td>15.53</td> <td>DUT 16</td><td>20.20</td> </tr> </tbody> </table>	Path losses per DUT. Values 0.00 to 40.00dB.				DUT 1	19.1	DUT 5	16.68	DUT 2	17.41	DUT 6	13.05	DUT 3	18.07	DUT 7	19.19	DUT 4	19.11	DUT 8	29.64	DUT 9	17.71	DUT 11	25.26	DUT 10	27.18	DUT 12	17.06	DUT 13	32.02	DUT 14	14.2	DUT 15	15.53	DUT 16	20.20															
Path losses per DUT. Values 0.00 to 40.00dB.																																																					
DUT 1	19.1	DUT 5	16.68																																																		
DUT 2	17.41	DUT 6	13.05																																																		
DUT 3	18.07	DUT 7	19.19																																																		
DUT 4	19.11	DUT 8	29.64																																																		
DUT 9	17.71	DUT 11	25.26																																																		
DUT 10	27.18	DUT 12	17.06																																																		
DUT 13	32.02	DUT 14	14.2																																																		
DUT 15	15.53	DUT 16	20.20																																																		
21	Verify	Repeat steps 10 to 13 with the 10 PCBAs. Check the GU RX RSSI results in the 10 CSV files. The results should be very close to -10dBm.																																																			

Appendix F Hex2Bin

This section gives a step-by-step example of using the `hex2bin.exe` utility, which converts Intel HEX files into binary format. See [Figure 166](#).

1. Put the `hex2bin.exe` file in same directory as the HEX files to be converted.
2. Open a Command Line Interface (CLI) in the same directory, e.g. by using <Shift>+<Right Click> and selecting 'Open command window here'.
3. Enter "`hex2bin -c blinky_1.hex`".
4. The binary file (`blinky_1.bin`) will be produced in the same directory.

[Figure 165](#) shows the directory and the files used in this example.

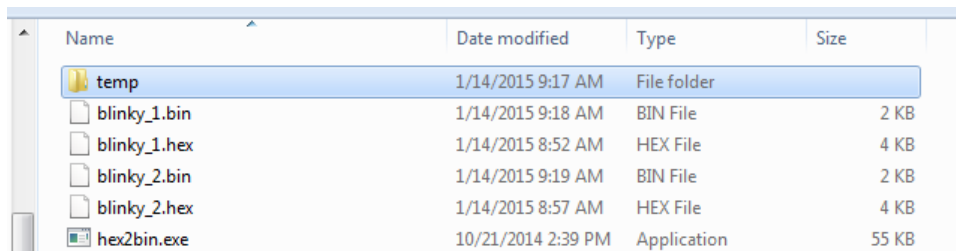

Figure 165: Hex2Bin Example Directory with Files

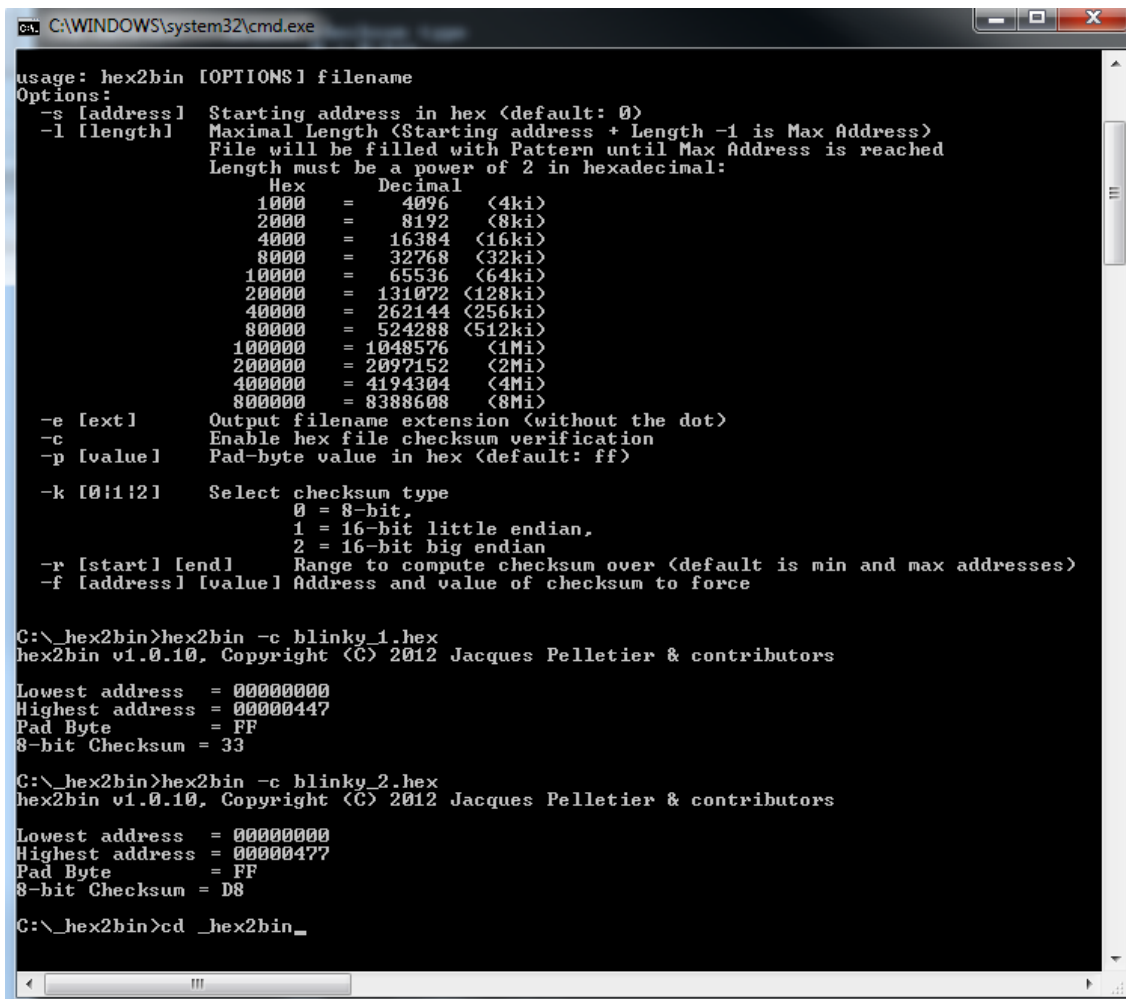

Figure 166: Hex2Bin.exe Example

Appendix G Bin2Image

Figure 168 shows an example of using the `bin2image.exe` utility, which creates a bootable-cached image for DA1468x devices.

The file `bin2image.exe` must be put in the same directory as the file to be converted. Figure 167 shows the directory and the files used in this example.

Name	Date modified	Type	Size
temp	7/27/2016 8:54 PM	File folder	
bin2image.exe	5/17/2016 9:53 PM	Application	44 KB
pxp_reporter.bin	10/16/2015 5:19 PM	BIN File	57 KB
pxp_reporter.bin.cached	7/27/2016 8:54 PM	CACHED File	57 KB

Figure 167: Bin2Image Example Directory with Files

```

C:\WINDOWS\system32\cmd.exe
C:\_Test>bin2image ?
Version: 1.8

bin2image type binary_file image_file [ AD [enable_uart] [ram_shuffling] ]

Convert the executable binary file 'binary_file' to a
bootable image file 'image_file'.
The 'type' argument defines what kind of image to be
generated:
  qspi_cached      QSPI flash image for cached mode <production & development paths>
  qspi_mirrored    QSPI flash image for mirrored mode <production path only>
  qspi_single_mirrored QSPI flash image for mirrored mode <development path only, qspi operating in single mode>
  otp_cached       OTP image for cached mode
  otp_mirrored     OTP image for mirrored mode

If argument 'AD' is passed, it commands the generation of
an image for version AD of the chip, whose header is 16
bytes long, instead of 8.
If 'AD' is passed:
- 'enable_uart' can be used to enable UART during boot
  <the default is not to enable it>
- 'ram_shuffling' can take value 0, 1, 2, or 3 to
  configure the DataRAM cell shuffling:
  0: 8 - 24 - 32 (default)
  1: 24 - 8 - 32
  2: 32 - 8 - 24
  3: 32 - 24 - 8

Note: For cached mode images, the MSBit of the length is set to 1

C:\_Test>bin2image qspi_cached pxp_reporter.bin pxp_reporter.bin.cached AD enable_uart
C:\_Test>
  
```

Figure 168: Bin2Image Example

Appendix H Automatic GU COM Port Find

For the GU COM port automatic recognition to operate, a special serial number should exist in the GU FTDI IC. Usually this serial number is programmed during PLT PCB manufacturing, but it may not exist in some older versions.

If the 'GU COM port find' operation does not work, then the steps described in should be followed.

Table 118: FTDI "DialogSemi" Serial Number

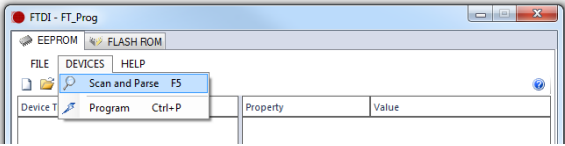
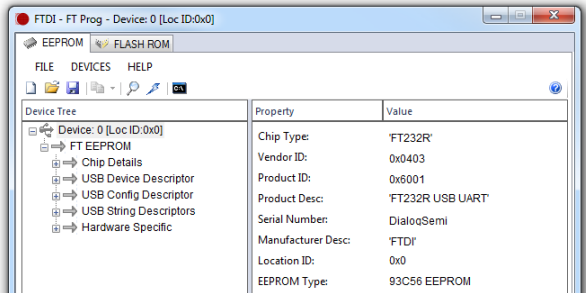
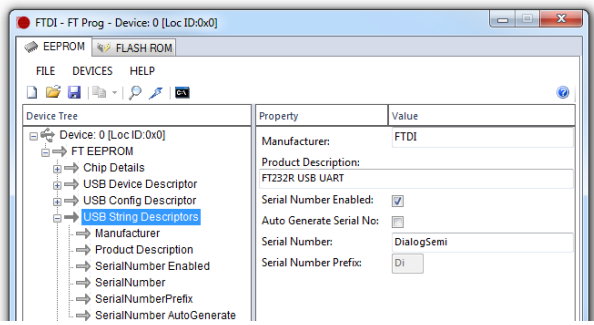
Step	Description
1	Download the FTDI FT_Prog tool from http://www.ftdichip.com/Support/Utilities.htm#FT_PROG .
2	Put power on the PLT board.
3	Remove any other USB FTDI connection to the PC.
4	Connect the USB cable of the GU to the PC.
5	Check the Device Manager that the GU COM port has been found.
6	Run the FT_Prog.exe. 
7	Select 'Devices > Scan and Parse'. 
8	A single 'FT232' device should be found. 
9	Select 'USB String Descriptors'.
10	Uncheck the 'Auto Generate Serial No:'.
11	Edit 'Serial Number' to "DialogSemi" as shown below. 

DA1458x/DA1468x Production Line Tool

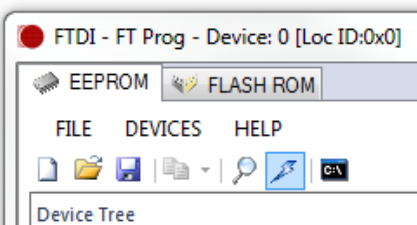
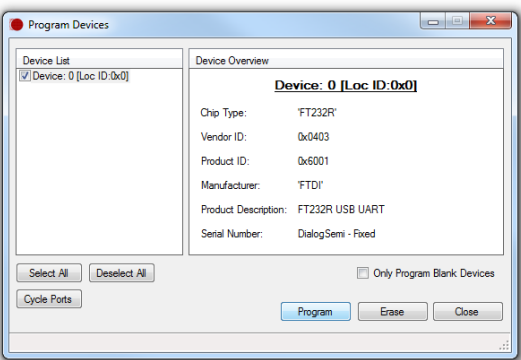
Step	Description
12	Press the 'Flash' button to program the change to the FTDI IC. 
13	Press 'Program' in the new window. 
14	Press 'Close'.
15	Unplug and reconnect the GU USB cable to the PC.
16	Verify the Serial Number change by running FT_Prog.exe again and reading the Serial Number value.

Appendix I Improving Cabling between PLT and DUTs

The following recommendations can be used to improve the connections between PLT and DUTs:

- Keep the lengths of the cables as short as possible.
- When possible use twisted pair cables instead of separate cables for:
 - GND/VBAT
 - GND/TxD
 - GND/RxD
 - GND/VPP
- Use ferrite beads for noise reduction in cables.

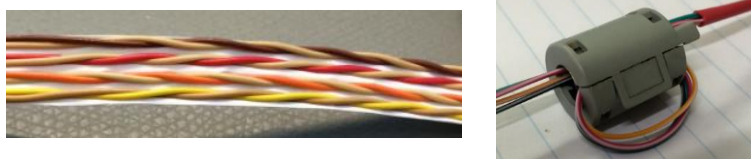

Figure 169: Example of Twisted Pair Cable with 4 Pairs and Ferrite

- Connect pull-down resistors at the end of the PLT TX signal lines. Use a 4.7 kΩ resistor at PLT DUT Connector Pin 7 (DUT TX) with the other end connected to ground. In total 16 resistors must be mounted, one for each PLT DUT connector.
- Connect a pull-down resistor as close as possible to the UART RX signal connector on the DUT. The value should be approximately 4.7 kΩ. Connect the other end of the resistor to ground.
- Use gold plated contacts in the connections between the PLT and the DUTs.
- Use extra drivers in the UART lines.
- Use series resistors of approximately 100 Ω in the UART lines, one mounted at the beginning and one at the end of the signal lines.

Note: Start with the simple solutions first by testing them one-by-one for stability.

Figure 170 and Figure 171 show examples of some of the above proposals.

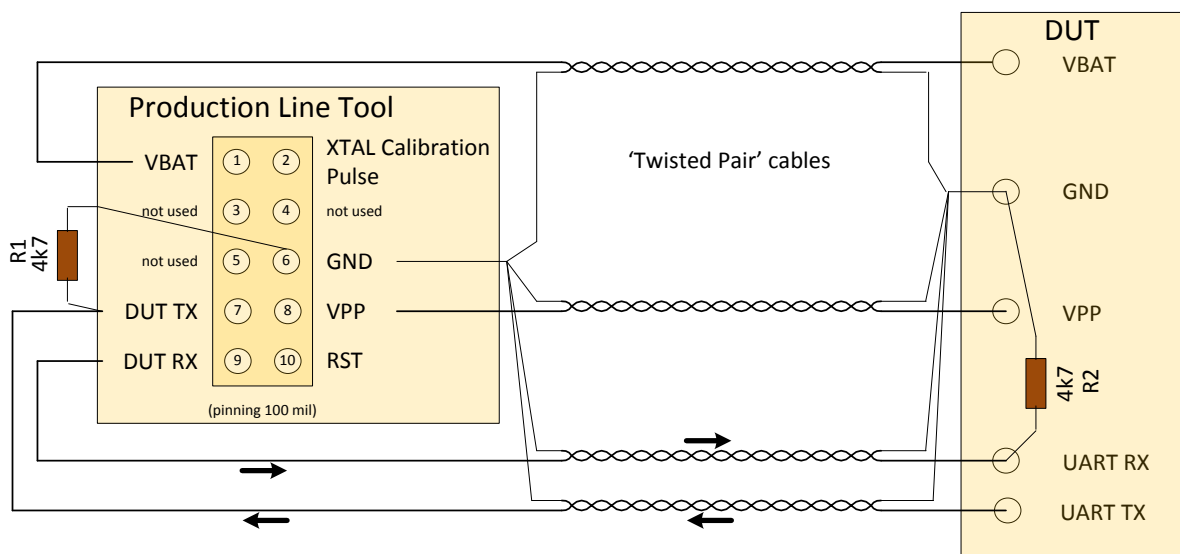

Figure 170: Location of Pull-Down Resistors

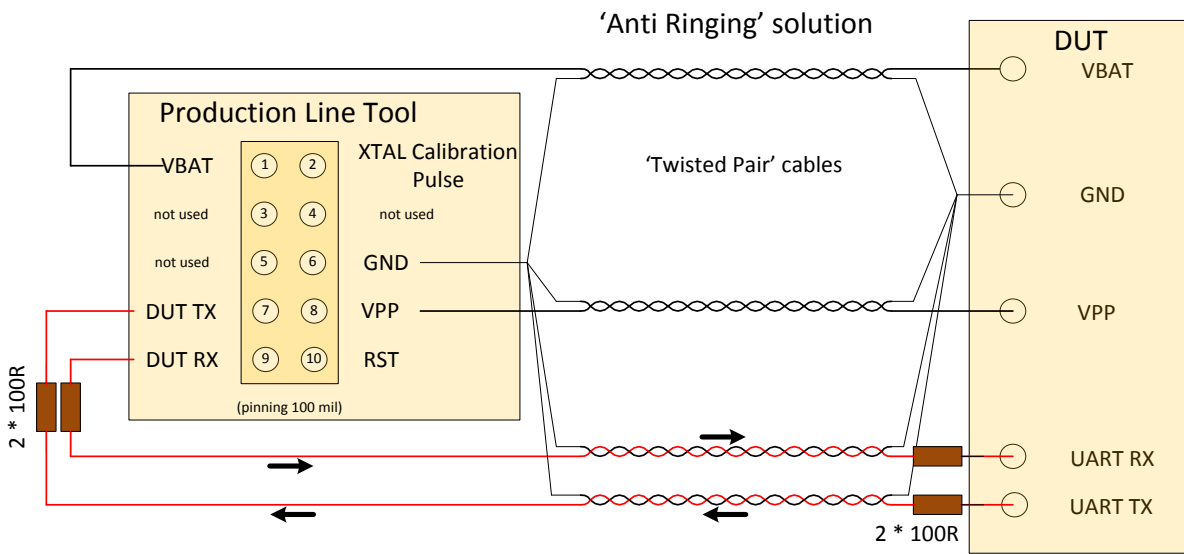

Figure 171: Anti-Ringing Solution

Appendix J DA14583 Internal SPI Flash Memory

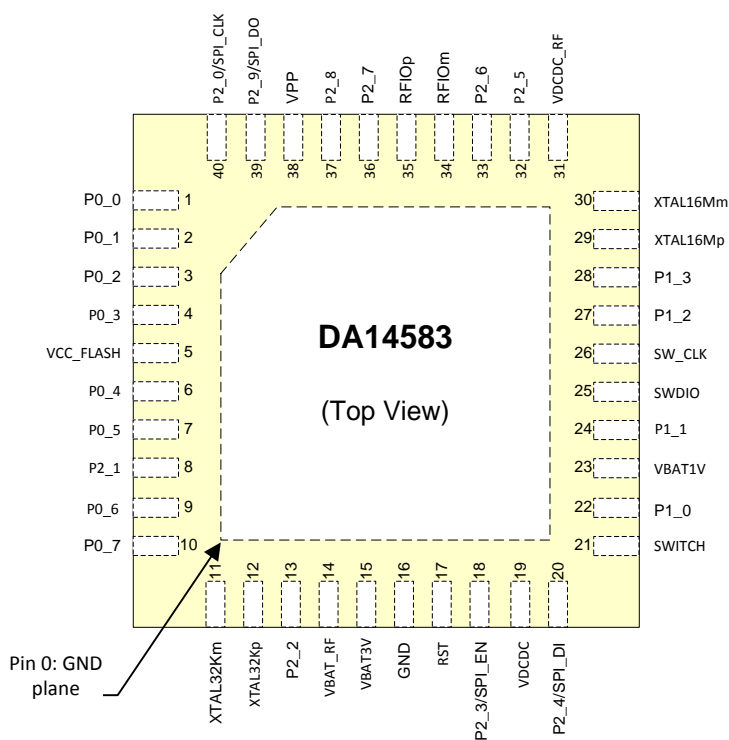

Figure 172: Pin Assignment of DA14583 – QFN40

DA14583 is the SPI master in regard to the internal SPI flash memory.

Table 119: DA14583 Internal SPI Flash Connections

DA14583 Pin	SPI Function	Description
P2_0	SPI_CLK	SPI Clock
P2_4	SPI_DI (in)	MISO
P2_9	SPI_DO (out)	MOSI
P2_3	SPI_EN	SPI Chip Select

Appendix K DA14586 Internal SPI Flash Memory

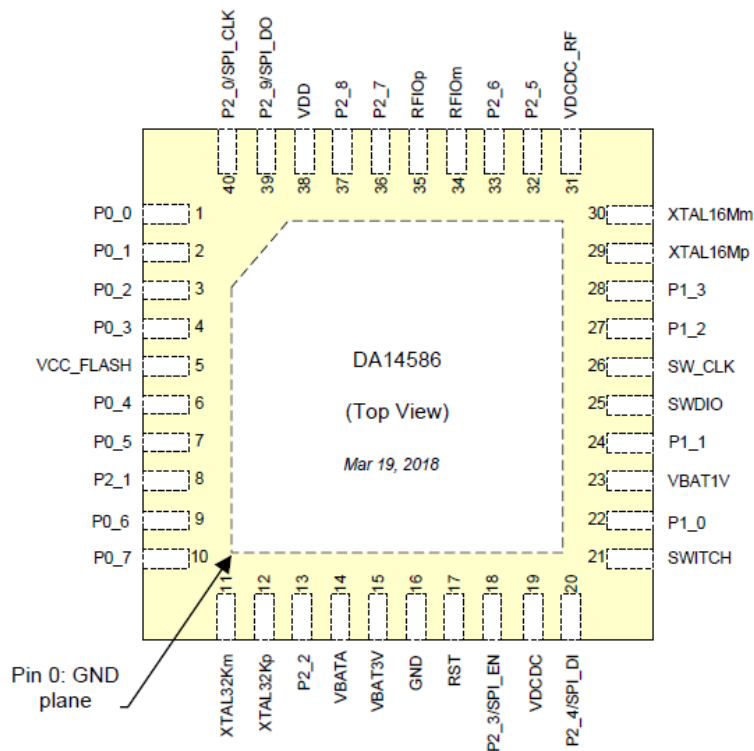

Figure 173: Pin Assignment of DA14586 - QFN40

DA14586 is the SPI master in regard to the internal SPI flash memory.

Table 120: DA14586 Internal SPI Flash Connections

DA14586 Pin	SPI Function	Description
P2_0	SPI_CLK	SPI Clock
P2_4	SPI_DI (in)	MISO
P2_9	SPI_DO (out)	MOSI
P2_3	SPI_EN	SPI Chip Select

Appendix L Honeywell Xenon 1900 Barcode Scanner Setup

In order to use the Honeywell Xenon 1900 then please follow the steps below to appropriate set it up for PLT usage.

1. Download Xenon-UG.pdf User Guide.
2. Scan Restore factory defaults at page 198 (Resetting the Factory Defaults)
3. Program the USB to Serial Interface. Scan code at Page 32 (TRMUSB130)
4. Download Xenon USB to Serial drivers HSM USB Serial Driver version 3.5.5.zip

DA1458x/DA1468x Production Line Tool

Appendix M Golden Unit Upgrade Using Smart Snippets Toolbox

The SPI Flash memory of the Golden Unit can be programmed as any DA14580 device, using the JTAG connector next to the Golden Unit and the Smart Snippets Toolbox application.

1. Connect the power supply to the PLT hardware as described in [PLT Power Supply](#).
2. Connect the USB cable of the Golden Unit.
3. Connect the JTAG (J2) of the Golden Unit.
4. Open the Smart Snippets Toolbox and select the JTAG method and the DA14580 chip.
5. Under the “Layout” category, on the “Booter & Board Setup page”, the GPIOs for the Flash memory should be the following: CLK: P0_0, CS: P0_3, MISO: P0_5, MOSI: P0_6.
6. Under the “Tools” category, on the “SPI Flash Programmer” tab, using the “Browse” button, select the “prod_test_GU.bin” binary which is under the `DA1458x_DA1468x_PLT_v4.x/binaries/GU/prod_test_GU.bin` folder on the PLT software package.
7. After the binary is loaded on the Smart Snippets Toolbox, press “Connect” at the bottom. This will download a firmware on the Golden Unit and set the SPI Flash GPIOs to program the memory.
8. Select “Erase” to completely erase the Flash memory before burning the new firmware.
9. Select “Burn and Verify”. On the pop-up message, select to make the firmware bootable.
10. Remove the JTAG from the PLT hardware and then manually reset the Golden Unit using the reset button next to it. The Golden Unit has now booted with the new firmware.

DA1458x/DA1468x Production Line Tool

Appendix N Connecting a Speaker to the Golden Unit for Audio Test

PLT is able to perform audio test for DA14582, DA14585 and DA14586 devices. The audio test settings are described in [Audio Test](#). A speaker can be connected to the Golden Unit using GPIOs P1_0 (AL4) and P1_1 (AL5) as shown in [Figure 174](#) to generate the 4 kHz tone.



Figure 174: Speaker Connection for Audio Test.

DA1458x/DA1468x Production Line Tool

Appendix O FTDI Driver Removal and Installation

In order to re-install the latest FTDI drivers, the previous should be uninstalled.

FTDI driver removal:

1. Download CDM uninstaller from <http://www.ftdichip.com/Support/Utilities.htm#CDMUninstaller>.
2. Run `CDMuninstallerGUI.exe`
3. The VID/PID of the PLT FTDIs are VID=0403/PID=6011 for the DUTs and VID=0403/PID=6001 for the GU.
Enter these VIDs and PIDs in the CDM Uninstaller and press add for each one.
4. Then press `Remove Devices` to uninstall the FTDI drivers.
5. Un-plug both USB cables.

More information can be found in the following link:

http://www.ftdichip.com/Support/Utilities/CDM_Uninst_GUI_Readme.html

FTDI driver installation:

1. Download the latest drivers from <http://www.ftdichip.com/Drivers/VCP.htm> and install them using the executable.
2. After uninstalling the drivers, plug in both USB cables. Windows will automatically assign the new drivers. Do not remove the cables during driver installation. A driver installation error may occur and the removal-installation will have to be repeated.
3. Check in the Windows Device manager that the driver versions of the 17 PLT COM Ports->USB Serial Ports are the latest.

FTDI driver versions v2.12.24, v2.12.26 and 2.12.28 have been tested.

Appendix P DA1458x DK Pro Motherboard Connection

Figure 175 shows the wiring to a DA14580/1/2/3/5/6 Pro DK motherboard.

As described in [DUT Connector](#) the following connections are needed to connect a DUT to the PLT.

1. Ground. DUT connector pin6 <-> Pro DK J5 pin2.
2. VBAT. DUT connector pin1 <-> Pro DK J5 pin1.
3. UART Tx. DUT connector pin7 <-> Pro DK J5 pin11.
4. UART Rx. DUT connector pin9 <-> Pro DK J5 pin13.
5. Reset. DUT connector pin10 <-> Pro DK J5 pin3 (Optional).

If no power supply is provided through the USB cable (J12), the reset circuit will drive the reset pin of the DUT host board (connector J4) high, keeping the DUT at a reset state. To overcome this either the R84 resistor should be removed or the USB cable should be connected.

Additionally, J11 jumper should be removed. Power supply to the board will be provided from the PLT HW (VBAT line).

To use the onboard SPI flash memory J5 jumper configuration should be as shown on the silkscreen PCB print (left of J5). A special jumper must be used to connect the P0_5 (J5 – pin13) with the SPI MISO (J6 – pin2) and the PLT UART-Rx pin (on DUT connector – pin9).

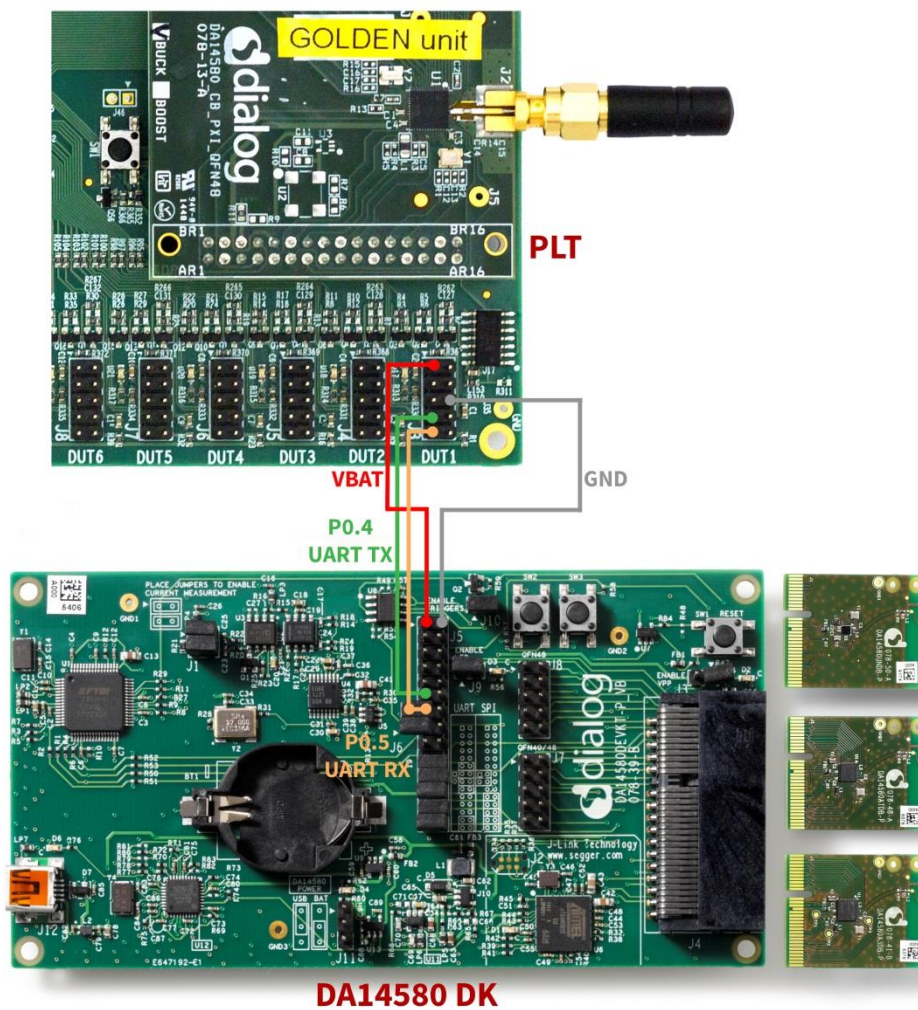

Figure 175: DA14580/5 Pro Motherboard DK Wiring.

Appendix Q DA1468x DK Pro Motherboard Connection

Figure 176 shows the wiring to a Pro DK motherboard for the DA14680/1/2/3 DUTs.

As described in [DUT Connector](#) the following DUT connections are needed to connect a DUT to the PLT:

1. Ground. DUT connector pin6 <-> Pro DK J3 pin22.
2. VBAT. DUT connector pin1 <-> Pro DK J3 pin24.
3. UART Tx. DUT connector pin7 <-> Pro DK J4 pin8.
4. UART Rx. DUT connector pin9 <-> Pro DK J3 pin19.
5. Reset. DUT connector pin10 <-> Solder to Reset button (K2) (Optional).

All board jumpers must be removed. Power supply will be provided from the PLT HW (VBAT line).

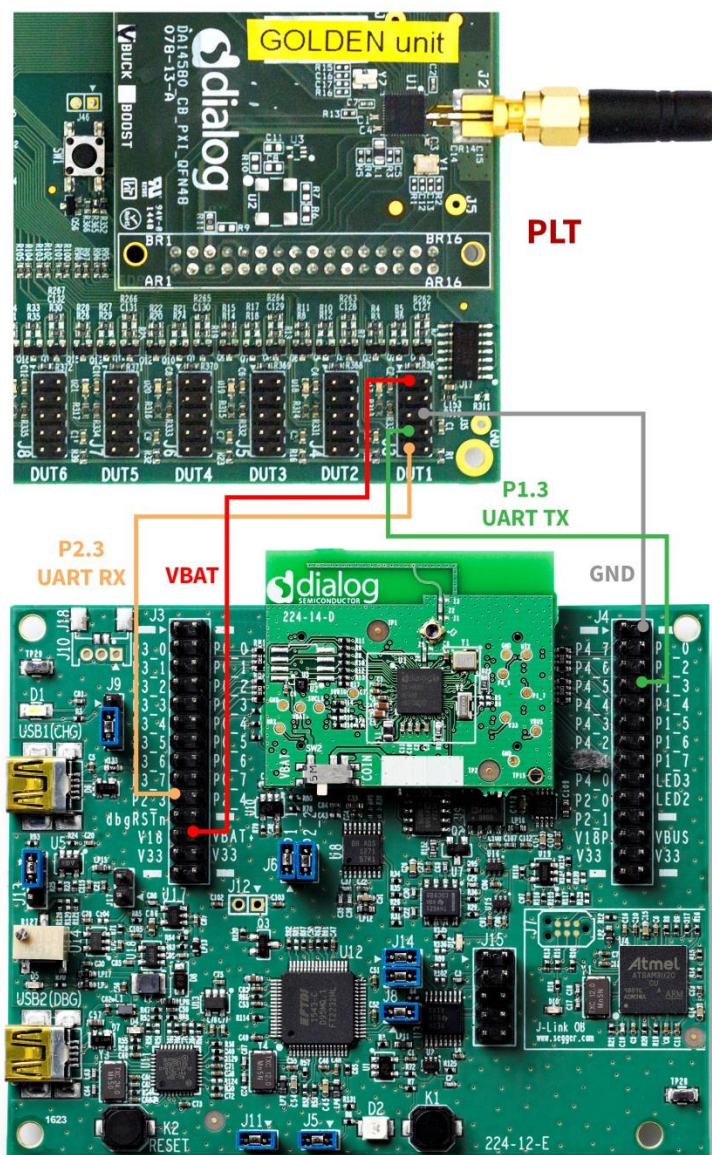

Figure 176: DA14680/1/2/3 Pro Motherboard DK Wiring.

Appendix R Connecting DA1468x DK Pro Motherboard for Current Measurements

DA1468x DK Pro motherboards are equipped with current measurement modules. Therefore, they can operate as external ammeter instruments with the PLT.

The DA1468x DK Pro motherboard should be connected to J26 as shown in [Figure 177](#). A three-wire connection has to be made between the PLT board and the motherboard. Jumpers J9 should be removed from the DA1468x DK Pro motherboard. It is mandatory to have a common ground between the two boards. One possible ground connection is shown with the purple line.

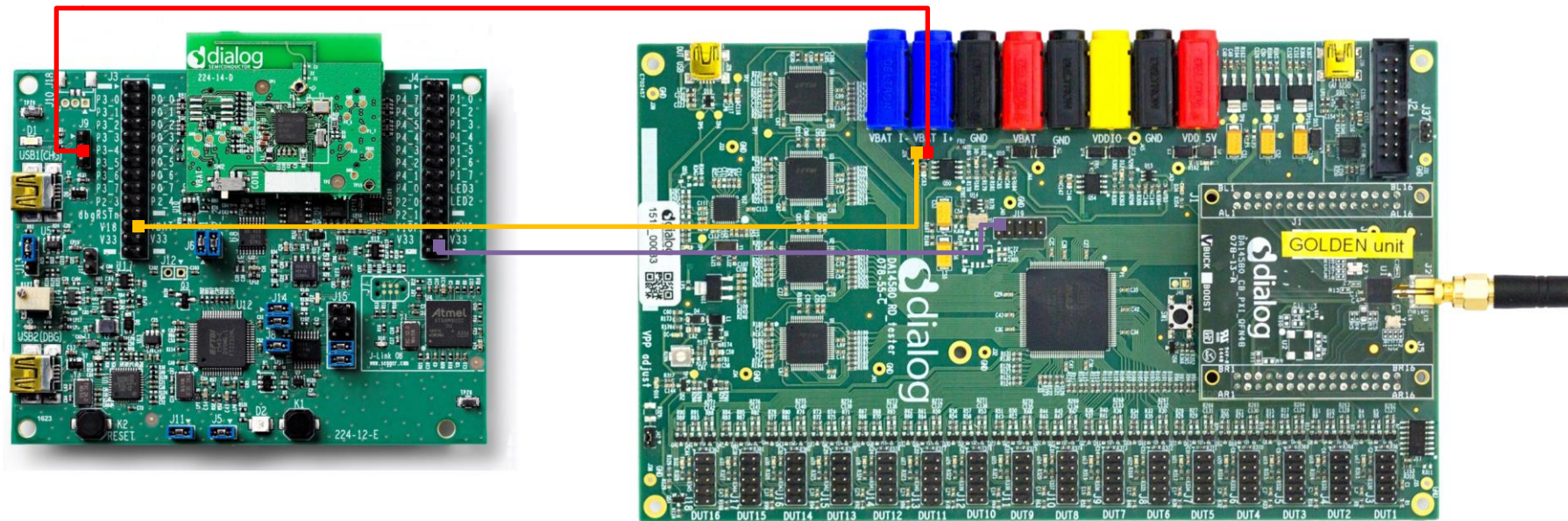

Figure 177: DA1468x PRO DK Ammeter Connection with PLT

DA1458x/DA1468x Production Line Tool

To use the DA1468x Pro motherboard as current measurement instrument in PLT, the `ammeter_da1468x_dk.dll` should be selected in [Current Measurement Test](#) (DA1458x) or [Current Measurement Test](#) (DA1468x) test settings panel. The interface should be set to the second FTDI COM port enumerated in Windows, as shown in [Figure 178](#).



Figure 178: DA1468x DK PRO Current Measurement Settings

DA1458x/DA1468x Production Line Tool

Appendix S Connecting DUT with Battery Supply

Wiring connections to a battery powered DUT is described in [DUT Connector](#). Example connections can be found in chapters [DA1458x DK Pro Motherboard Connection](#) and [DA1468x DK Pro Motherboard Connection](#).

1. Four wires are mandatory for the connection:
 - Common Ground
 - UART Tx
 - UART Rx
 - Reset line
2. [VBAT as Reset](#) mode is the only mode supporting battery powered DUTs since POR cannot be performed. In order for the PLT to perform a reset on the DUTs, the VBAT line of each DUT connector must be connected to the reset line of the DUT as described in [VBAT as Reset](#) mode.
3. Current measurement is not supported, since there is no way to measure the current of the DUTs.
4. In order to program the OTP for the DA14580/1/2/3 DUTs an external VPP voltage must be supplied. VPP lines on the DUT connectors will not provide any voltage in [VBAT as Reset](#) mode so they cannot be used.

In order to have the least possible wiring connections, UART Rx line can also be used as input GPIO for the pulse used during the XTAL Trim procedure as described in [XTAL Trim](#) and [XTAL Trim](#).

Appendix T User Interfaces Shortcut Keys

Table 121: User Interface Shortcut Keys

Application	Shortcut	Description
CFG PLT Application	Ctrl + S	This shortcut is the equivalent of pressing the save button at the bottom of the screen.
GUI PLT Application	Space-Bar	It is used to select the 'Start' button to start testing.
	F	It is the equivalent of pressing the 'Finished' button with the left mouse-click.

DA1458x/DA1468x Production Line Tool

Appendix U DA1458x Supported SPI Flash\EEPROM Memories

Table 122 describes the supported SPI Flash and EEPROM memories for DA1458x devices. To use a memory not shown in the list, [SPI Flash Configuration](#) or [I2C EEPROM Configuration](#) can be used.

Table 122: DA1458x Supported SPI Flash Memories

Memory type	Memory vendor	Product number
SPI Flash memory	Windbond	W25X10
		W25X20
		W25X40
	Adesto	AT25Dx011
		AT25XE021
		AT25XE041
	Macronix	MX25V1006E
		MX25R1035F
		MX25R2035F
		MX25R4035F
		MX25R8035F
		MX25R1635F
		MX25V1035F
		MX25V2035F
		MX25V4035F
MX25V8035F		
MX25V1635F		
I2C EEPROM	ST	M24M02

Appendix V DA1468x Supported QSPI Flash Memories

Table 123 describes the supported QSPI flash memories for DA1468x devices. In order to support a QSPI flash memory that is not in the list, follow the DA1468x QSPI Flash Support `{#flash_support}` instructions in `readme.md` file located under `DA1468x_DA15xxx_SDK_1.0.12.1078\DA1468x_DA15xxx_SDK_1.0.12.1078\sdk\bsp\memory\` folder to manually add it inside the `uartboot.bin` firmware.

Table 123: DA1468x Supported QSPI Flash Memories

Memory vendor	Product number
Windbond	W25Q80EW
Gigadevice	GD25LQ80B
Macronix	MX25U51245
ISSI	IS25LP128

DA1458x/DA1468x Production Line Tool

Appendix W BLE Tester Measurement Results

When using an MT8852B as an external BLE tester instrument for the DA1458x [RF Tests](#) and DA1468x [RF Tests](#), PLT will instruct the MT8852B to perform specific tests and then wait for its reply. MT8852B replies with a string, containing the command code of the test performed followed by the results of the test or an [Error Response](#) string.

[Table 124](#) shows the result command codes.

The PDF in the following link describes the format of the result string for each command code, under chapter 15 – 7.

<https://dl.cdn-anritsu.com/en-au/test-measurement/files/Manuals/Programming-Manual/MT8852B/MT8852B-Bluetooth%20tester-Programming%20Manual%20Rev%20X.pdf>

Table 124: MT8852B Supported Command Codes

Code	Test
LEOP0	TX power
LEICD0	Carrier frequency and Drift
LEMI	Modulation index
ERRLST	Error response

As an example, the test results of DUT1 in the example of [CSV Log File Contents](#) will be used.

Tx Power

The result of DUT1 for the TX-Power test is:

```
TRUE;-14.25;-14.25;-14.25;0.10;0;2;PASS
```

Table 125: MT8852B – BLE TX Output Power Test Results

Description	Format	Example
Results valid	TRUE FALSE	TRUE
Packet average power in dBm	floating point	-14.25
Test avg max in dBm	floating point	-14.25
Test avg min in dBm	floating point	-14.25
Test peak to average power in dBm	floating point	0.10
Number of failed packets	integer	0
Number of tested packets	integer	2
Pass/fail result	PASS FAIL	PASS

DA1458x/DA1468x Production Line Tool
Frequency Offset

The result of DUT1 for the Frequency Offset test is:

TRUE;-2.500e+003;2.800e+003;-7.800e+003;-7646;-9.0e+003;-9.0e+003;0;2;PASS;-7646

Table 126: MT8852B – BLE Carrier Frequency Offset and Drift Test Results

Description	Format	Example
Drift rate valid	TRUE FALSE	TRUE
Average Fn	Integer	-2.500e+003
Maximum Positive Fn	Integer	2.800e+003
Minimum Negative Fn	integer	-7.800e+003
Drift rate	integer	-7646
Average drift	integer	-9.0e+003
Maximum drift	integer	-9.0e+003
Packets Failed	integer	0
Packets Tested	integer	2
Pass/fail result	PASS FAIL	PASS
Initial drift rate	integer	-7646

Modulation Index

The result of DUT1 for the Modulation Index test is:

TRUE;282100.00;249100.00;200700.00;248700.00;1.00;0;576;1;1;FAIL;100.00%

The tester responded with FAIL because two tests with different patterns were needed. The overall result of the Modulation Index test will be concluded in a second step, after the second payload is tested.

Table 127: MT8852B – BLE Modulation Characteristics Test Results

Description	Format	Example
Results valid	TRUE FALSE	TRUE
Delta f1 max in Hz	floating point	282100.00
Delta f1 average in Hz	floating point	249100.00
Delta f2 max in Hz (Delta f1 max lowest for BLR8)	floating point	200700.00
Delta f2 average in Hz (omitted for BLR8)	floating point	248700.00
Delta f2 avg / delta f1 avg (Omitted for BLR8)	floating point	1.00
Delta f2 max Failed limit (Delta f1 max Failed limit for BLR8)	integer	0
Delta f2 max count (Delta f1 max count for BLR8)	integer	576
Packets failed	integer	1
Packets tested	integer	1
Pass/fail result	PASS FAIL	FAIL

DA1458x/DA1468x Production Line Tool

Description	Format	Example
Delta f2 max % pass rate (Delta f1max % pass rate for BLR8)	floating point	100.00%

Error Response

If the BLE Tester fails to perform the tests it will respond with an error. [Table 128](#) describes the parts of the error message. More details can be found in chapter 4.3 of the following link:

<https://dl.cdn-anritsu.com/en-au/test-measurement/files/Manuals/Programming-Manual/MT8852B/MT8852B-Bluetooth%20tester-Programming%20Manual%20Rev%20X.pdf>

The format of the response message is

```
ABCCDDEFGHIIJKK!LLLLLLL!MMMMMM!NNNNNN!OOOOOO!
```

A common error response, which is not an actual error, is the message below:

```
00000000000000!NO ERRORS!NO ERRORS!!!
```

This is due to the output received signal may be less than -50dB.

Table 128: MT8852B – Error List

Alias	Error	Status	Description
A	CONNECTION ALREADY EXISTS	0	No previous connection
		1	Connection already exists
B	EUT TEST MODE STATE	0	EUT Test Mode enabled
		1	EUT Test Mode not enabled
CC	EUT HCI ERROR	00	OK
		XX	2 digit hex error code (EUT controlled via RS232)
DD	INTERNAL HCI ERROR	00	OK
		XX	2 digit hexadecimal error code
E	INTERNAL SYNC ERROR	0	OK
		1	Internal HCI synchronization error
F	EUT SYNC ERROR	0	OK
		1	EUT HCI synchronization error (control via RS232)
G	EUT HARDWARE ERROR	0	OK
		1	EUT Reported HCI Hardware error message
H	REQUEST FAILED	0	OK
		1	Request failed (system busy)
II	DSP STATUS Note: Setting of the DSP status code will not set the DDE bit of the event register	00	OK
		01	Searching channel
		02	Searching sync word
		03	Incorrect packet length
		04	No payload
		05	Auto ranging
		06	Incorrect packet
		07	Incorrect packet type
		08	Over range

DA1458x/DA1468x Production Line Tool

Alias	Error	Status	Description
		09	Under range
		10	Invalid payload
		11	Error finding start of packet using power profile
		12	Error locating P0/GFSK sync word
		13	Location of P0/GFSK sync word exceeds allowed limits
		14	Error locating EDR sync word
		15	Location of EDR sync word exceeds allowed limits
		16	Error decoding the packet type field
		17	Modulation mode of PI/4-DQPSK or 8DPSK not specified
		18	Specified (pi/4-DQPSK) modulation mode does not agree with detected packet type
		19	Specified (8DPSK) modulation not match with packet type
		20	Invalid packet type decoded
		21	Unknown packet type decoded
		22	Expected and measured packet lengths do not match
23	Insufficient blocks in packet for measurement		
J	EUT BT ADDRESS	0	OK
		1	EUT Bluetooth Address set (in Manual mode)
KK	HCI COMM STATUS	00	OK
		01	Unknown HCI command
		02	No connection
		03	Hardware failure
		04	Paging timeout
		05	Connection timeout
		06	Unsupported feature parameter
		07	Connection ended by user
		08	Low resource connection ended
		09	Power Off connection ended
		10	Local host connection ended
		11	Unsupported remote feature
		12	Role change not allowed
		13	LMP response timeout
14	IQ modem DAC saturation		
LLLLLLL		Internal core error text (variable length)	
MMMMMMM		EUT core error text (variable length)	
NNNNNNN		Last GPIB command that caused a Command error (variable length)	
OOOOOOO		Last GPIB command that caused an Execution error (variable length)	

DA1458x/DA1468x Production Line Tool

Appendix X Memory programming

This appendix lists all possible memory programming operations. The memory operations are grouped per chipset and memory type.

X.1 DA14580/1/2/3/5/6 Memory Programming Tests

OTP

Table 129: DA1458x Memory Programming – OTP Memory

Test Name	Operation	No.	Description
XTAL Trim	Read\ Write	1	The XTAL trim procedure will first read the OTP XTAL trim header area to check it has a value. If it is blank, after the automated XTAL Trim calibration finishes, it will burn the value.
OTP Memory	Write\ Verify	1	This operation writes the user selected binary into the OTP memory. The start address will always be address 0. If <i>Verify</i> is selected, PLT will read the OTP contents for the size of the binary burned and compare it with the actual binary. If the binary size is larger than the OTP image area, PLT considers that the binary contains the header as well. PLT can also program the following during OTP image burn. <ul style="list-style-type: none"> DMA length
OTP Header	Write\ Verify	1	The OTP header write operation will write any non-zero header field one by one. If the <i>Verify</i> option is selected it will read the OTP header fields and compare them to the ones written before.
BD Address	Write\ Verify	1	The BD address write procedure will write the BD address field in the OTP header area. If the <i>Verify</i> option is selected, PLT will read the OTP BD address and compare it to the one written before.
	Read\ Compare	1	This will read the BD address field from the OTP header and save it to the DUT logs. If the <i>Compare</i> option is selected it will compare the address read with the one PLT uses for the particular device.
Memory read	Read	10 ¹	The memory read procedure can read any OTP memory area and save the results in the DUT logs.
Custom Memory Data	Barcode scanner	1	This procedure will write data with a given size at a given address offset. A barcode scanner is used as data input. If the <i>Verify</i> option is selected, PLT will read the contents and compare it to the one written before.
	CSV file	5 ¹	This procedure will read the memory programming parameters from a CSV file. Up to 5 memory writes can be set. If the <i>Verify</i> option is selected, PLT will read the memory contents and compare them to the ones written before.
	Manual	1	The manual procedure will write data with a given size at a given address offset. If the <i>Verify</i> option is selected, PLT will read the memory contents and compare them to the ones written before.

Note 1 Applies for all available memories simultaneously.

Note 2 Check *Empty* is performed by reading the memory contents and checking whether these are all zeros.

Note 3 Check *if data match* is performed by reading the memory contents and checking whether these are all zeros or the data to be written are the same.

Note 4 If the OTP part to be written contains all-zero values, then the write operation will not be performed. This also applies for writing default values in the OTP header.

DA1458x/DA1468x Production Line Tool

SPI Flash

Table 130: DA1458x Memory Programming - SPI Flash

Test Name		Operation	No.	Description
SPI Flash Configuration		Initialize	1	The memory programming firmware can auto-detect the memories listed in Table 122 . However, PLT can also use a user-defined SPI flash configuration. PLT will send a command containing the SPI configuration set by the user. For the DA14583 and DA1586 devices, this option is disabled because PLT initializes the firmware with the internal SPI flash characteristics.
SPI Flash Memory		Erase	10	The erase operation can perform up to 10 erase tests, which can erase either the entire memory or specific sections.
		Check Empty	10	This can perform up to 10 different check empty operations, which will verify that specific sections or the entire memory is empty.
		Write\ Verify	10	This operation will write a user defined binary at a given offset or at offset 0 if it is a bootable image. If the <i>Verify</i> option is selected, PLT will read the contents and compare it to the one written before.
Memory read		Read	10 ¹	The memory read procedure can read any field of the SPI memory and save the data into the DUT logs.
Custom Memory Data	Barcode scanner	Write\ Verify	1	This procedure will write data with a given size at a given address offset. A barcode scanner is used as data input. If the <i>Verify</i> option is selected, PLT will read the contents and compare it to the one written before.
	CSV file		5 ¹	This procedure will read the memory programming parameters from a CSV file. Up to 5 memory writes can be set. If the <i>Verify</i> option is selected, PLT will read the memory contents and compare them to the ones written before.
	Manual		1	The manual procedure will write data with a given size at a given address offset. If the <i>Verify</i> option is selected, PLT will read the memory contents and compare them to the ones written before.

Note 1 Applies for all available memories simultaneously.

EEPROM

Table 131: DA1458x Memory Programming – EEPROM Memory

Test Name		Operation	No.	Description
I2C EEPROM Configuration		Initialize	1	The memory programming firmware can auto-detect the memories listed in Table 122 . However, PLT can also use a user-defined EEPROM configuration. PLT will send a command containing the EEPROM configuration set by the user.
I2C EEPROM Memory		Write\ Verify	10	This operation will write a user defined binary at a given offset or at offset 0 if it is a bootable image. If the <i>Verify</i> option is selected, PLT will read the contents and compare it to the one written before.
Memory read		Read	10 ¹	The memory read procedure can read any field of the SPI memory and save the data into the DUT logs.
Custom Memory Data	Barcode scanner	Write\ Verify	1	This procedure will write data with a given size at a given address offset. A barcode scanner is used as data input. If the <i>Verify</i> option is selected, PLT will read the contents and compare it to the one written before.
	CSV file		5 ¹	This procedure will read the memory programming parameters from a CSV file. Up to 5 memory writes can be set. If the <i>Verify</i> option is selected, PLT will read the memory contents and compare them to the ones written before.
	Manual		1	The manual procedure will write data with a given size at a given address offset. If the <i>Verify</i> option is selected, PLT will read the memory contents and compare them to the ones written before.

Note 1 Applies for all available memories simultaneously.

X.2 DA1468x Memory Programming Operation

OTP

Table 132: DA1468x Memory Programming – OTP Memory

Test Name	Operation	No.	Description
XTAL Trim	Write\ Verify	1	The XTAL trim procedure will first find an available OTP TCS field to write the value even if another XTAL trim value is programmed at a previous TCS field. If the <i>Verify</i> option is selected it will read the OTP TCS section field and compare them to the one written before.
OTP Memory	Write\ Verify	1	This operation writes the user selected binary into the OTP memory. The start address will always be address 0. If <i>Verify</i> is selected, PLT will read the OTP contents for the size of the binary burned and compare it with the actual binary. If the binary size is larger than the OTP image area, PLT considers that the binary contains the header as well. PLT can also program the following during OTP image burn. <ul style="list-style-type: none"> • DMA length • Image CRC
OTP Header	Write\ Verify	1	The OTP header write operation will write any non-zero header field one by one. If the <i>Verify</i> option is selected it will read the OTP header fields and compare them to the ones written before.
OTP Header - BD Address	Write\ Verify	1	The BD address write procedure will write the BD address field in the OTP header area. If the <i>Verify</i> option is selected, PLT will read the OTP BD address and compare it to the one written before.
	Read\ Compare	1	This will read the BD address field from the OTP header and save it to the DUT logs. If the <i>Compare</i> option is selected it will compare the address read with the one PLT uses for the particular device.
Memory read	Read	10 ¹	The memory read procedure can read any OTP memory area and save the results in the DUT logs.
Custom Memory Data	Barcode scanner	1	This procedure will write data with a given size at a given address offset. A barcode scanner is used as data input. If the <i>Verify</i> option is selected, PLT will read the contents and compare it to the one written before.
	CSV file	5 ¹	This procedure will read the memory programming parameters from a CSV file. Up to 5 memory writes can be set. If the <i>Verify</i> option is selected, PLT will read the memory contents and compare them to the ones written before.
	Manual	1	The manual procedure will write data with a given size at a given address offset. If the <i>Verify</i> option is selected, PLT will read the memory contents and compare them to the ones written before.

Note 1 Applies for all available memories simultaneously.

Note 2 Check *Empty* is performed by reading the memory contents and checking whether these are all zeros.

Note 3 Check *if data match* is performed by reading the memory contents and checking whether these are all zeros or the data to be written are the same.

Note 4 If the OTP part to be written contains all-zero values, then the write operation will be omitted. This also applies for writing default values in the OTP header.

DA1458x/DA1468x Production Line Tool

QSPI

Table 133: Memory Programming – QSPI Memory

Test Name	Operation	No.	Description
XTAL Trim	Write\ Verify	1	The XTAL trim QSPI write procedure will write the XTAL trim value found during the calibration process to the user defined QSPI address. If the <i>Verify</i> option is selected, PLT will read the QSPI user defined address contents and compare them to the ones written before.
QSPI Flash Memory	Erase	10	The erase operation can perform up to 10 erase tests, which can erase either the entire memory or specific sections.
	Check Empty	10	This can perform up to 10 different check empty operations, which will verify that specific sections or the entire memory is empty.
	Write\ Verify	10	This operation will write a user defined binary at a given offset or at offset 0 if it is a bootable image. If the <i>Verify</i> option is selected, PLT will read the contents and compare it to the one written before.
QSPI Header - BD Address	Write\ Verify	1	The BD address write procedure will write the BD address field in the QSPI user defined address. If the <i>Verify</i> option is selected, PLT will read the data from QSPI user defined address and compare them with the ones written before.
	Read\ Compare	1	This will read the BD address field from the QSPI user defined address and save it to the DUT logs. If the <i>Compare</i> option is selected it will compare the address read with the one PLT uses for the particular device.
Memory read	Read	10 ¹	The memory read procedure can read any field of the SPI memory and save the data into the DUT logs.
Custom Memory Data	Barcode scanner	1	This procedure will write data with a given size at a given address offset. A barcode scanner is used as data input. If the <i>Verify</i> option is selected, PLT will read the contents and compare it to the one written before.
	CSV file	5 ¹	This procedure will read the memory programming parameters from a CSV file. Up to 5 memory writes can be set. If the <i>Verify</i> option is selected, PLT will read the memory contents and compare them to the ones written before.
	Manual	1	The manual procedure will write data with a given size at a given address offset. If the <i>Verify</i> option is selected, PLT will read the memory contents and compare them to the ones written before.

Note 1 Applies for all available memories simultaneously.

Appendix Y CSV Log File Contents

Table 134 describes the CSV File columns generated during PLT testing. In general, not all CSV file columns shown in Table 134 will be printed, but only those that relate to the enabled tests and memory operations user has selected. An example is given in [CSV Log File Example](#).

Table 134: CSV File Contents

Header	Value	Description
Start time	hh:mm:ss	Shows the actual time the test procedure has started
End time	hh:mm:ss	Shows the actual time the test procedure has ended
DUT	1-16	The PLT connector for this device. Values 1-16.
BD address	XX:XX:XX:XX:XX:X X	The BD address assigned for this device.
Overall status	PASS\FAIL	The overall status of the test procedure for this device.
COM Port	XX	Windows assigned COM Port
Temperature test	PASS\FAIL	Shows the temperature measured during temperature test. The first column shows the result of the test. The second column shows the temperature measured.
Temperature	xx.xx	
FW download 1	PASS\FAIL	Production test FW download. The first column shows the result of the production test firmware download procedure. The second columns shows the path to the firmware.
FW path 1	C:\folder\to\bin	
RAM FW download	PASS\FAIL	Production test FW download through memory programming FW. The first column shows the result of the production test firmware download procedure. The second columns shows the path to the firmware.
RAM FW path	C:\path\to\bin	
FW version get 1	PASS\FAIL	Production test FW version. The first column shows the result of the test. The second column shows the production test FW version read back from each device.
FW version 1	e.g. "v_5.0.4_PLT_v4.3"	
GPIO Watchdog ['Test Name']	PASS\FAIL	GPIO watchdog toggling test for production testing FW
GPIO Watchdog mem ['Test Name']	PASS\FAIL	GPIO watchdog toggling test for memory programming FW
Scan HCI Adv [CH37-9\All]	PASS\FAIL	Scan test using Advertising through HCI. The first column shows the result of the test. The second column shows the calculated value in decimal.
Scan HCI Adv RSSI [CH37-9\All]	The RSSI value measured for this device.	
Extended\Deep sleep current test	PASS\FAIL	Current measurement test – sleep tests.

DA1458x/DA1468x Production Line Tool

Header	Value	Description
Extended\Deep sleep current	RES=[xxxxA]. LL=xxxxA]. HL=[xxxxA].	The first column shows the result of the test. The second column shows the calculated value, and the high and low limits used for this test.
Sleep clock select	PASS\FAIL	Sleep clock selection
XTAL trim test	PASS\FAIL	Automated XTAL Trim value calculation.
XTAL trim	e.g. "1155"	The first column shows the result of the test. The second column shows the calculated value in decimal.
ADC calibration	PASS\FAIL	ADC calibration test.
ADC calibration value	xx	The first column shows the result of the test. The second column shows the calculated value.
BLE TX power test 'X' [Test Name]	PASS\FAIL	Tx Power tests using external BLE Tester
BLE TX power 'X' [Test Name]	TRUE;-13.16;-13.16;-13.16;0.08;0;2;PASS	
BLE TX offset test 'X' [Test Name]	PASS\FAIL	Tx Frequency offset tests using external BLE Tester
BLE TX offset 'X' [Test Name]	TRUE;-1.100e+003;1.400e+003;-4.000e+003;2902;-3.0e+003;-3.0e+003;0;2;PASS;2503	
BLE TX modulation test 'X' [Test Name]	PASS\FAIL	Tx Modulation Index tests using external BLE Tester. The first column shows the result of the test. The second column shows the calculated value.
BLE TX modulation 'X' [Test Name]	TRUE;260600.00;253300.00;216800.00;248000.00;0.98;0;576;1;1;FAIL;100.00%	
BLE RX RSSI test 'X' [Test Name]	PASS\FAIL	Rx sensitivity tests using external BLE Tester. The first column shows the result of the test. The second column shows the RSSI value measured for this device. The third column shows the Packet Error Rate measured for this device.
BLE RX RSSI [Test Name]	The RSSI value measured for this device.	
BLE RX PER [Test Name]	The Packet Error Rate measured for this device.	
GU RX RSSI test 'X' [Test Name]	PASS\FAIL	Rx sensitivity tests using Golden Unit as Tester. The first column shows the result of the test. The second column shows the RSSI value measured for this device. The third column shows the Packet Error Rate measured for this device.
GU RX RSSI [Test Name]	The RSSI value measured for this device.	
GU RX PER [Test Name]	The Packet Error Rate measured for this device.	
GPIO/LED test 'X' [Test Name]	PASS\FAIL	GPIO/LED tests
GPIO connection test 'X' [Test Name]	PASS\FAIL	GPIO connection tests
Audio test	PASS\FAIL	Audio test.

DA1458x/DA1468x Production Line Tool

Header	Value	Description
Audio level	xx.xx	The first column shows the result of the test. The second column shows the power level measured of each device.
Sensor test 'X' ['Test Name']	PASS\FAIL	Sensor tests.
Custom test 'X' ['Test Name']	PASS\FAIL	Custom tests
32KHz Test	PASS\FAIL	External 32kHz crystal test
Range extender	PASS\FAIL	Range extender test
Peripheral test 'X' ['Test Name']	PASS\FAIL	Current measurement tests for peripherals.
Peripheral test current	RES=[xxxxA]. LL=xxxxA]. HL=[xxxxA].	The first column shows the result of the test. The second column shows the calculated value, and the high and low limits used for this test.
FW download 2	PASS\FAIL	Memory programming FW download.
FW path 2	C:\path\to\bin	The first column shows the result of the production test firmware download procedure. The second columns shows the path to the firmware.
FW version get 2	PASS\FAIL	Memory programming FW version.
FW version 2	e.g. "v_5.0.4_PLT_v4.3"	The first column shows the result of the test. The second column shows the memory programming FW version read back from each device.
QSPI init	PASS\FAIL	Initialize QSPI Flash memory.
QSPI jedec	xxxxxx	The first column shows the result of the test. The second columns shows the Jedec ID read back from the device.
QSPI erase 'X' ['Test Name']	PASS\FAIL	Erase the QSPI Flash memory test.
QSPI check empty 'X' ['Test Name']	PASS\FAIL	Verify that the QSPI Flash memory has been erased.
QSPI burn 'X' ['Test Name']	PASS\FAIL	QSPI image write test.
QSPI image	C:\path\to\bin	The first column shows the result of the test. The second columns shows the path to the firmware burnt.
QSPI BDA burn	PASS\FAIL	Write BD address value to QSPI Header.
QSPI BDA rd/cmp	PASS\FAIL	Read BD address written in QSPI Header and compare it with the one the device is currently using.
QSPI BDA read	XX:XX:XX:XX:XX:X X	The first column shows the result of the test. The second columns shows the BD address written in the QSPI header.
QSPI XTAL trim burn	PASS\FAIL	Write XTAL Trim value to QSPI Header.
QSPI write ADC calibration	PASS\FAIL	Write ADC calibration value to QSPI memory.
Custom memory burn	PASS\FAIL	Write on any available memory test.
Custom memory data	"Data from CSV file" or "xx..."	The first column shows the result of the test. The second columns shows whether the data are given from a CSV file or the contents written.
'SPI\OTP\EEPROM\QSPI' Memory read 'X' ['Test Name']	PASS\FAIL	Read any part of any available memory.

Header	Value	Description
Memory read data	xx...	The first column shows the result of the test. The second columns shows the contents read back.
SPI init	PASS\FAIL	Initialize SPI Flash memory.
SPI erase 'X' ['Test Name']	PASS\FAIL	Erase the SPI Flash memory test.
SPI empty 'X' ['Test Name']	PASS\FAIL	Verify that the SPI Flash memory has been erased.
SPI burn 'X' ['Test Name']	PASS\FAIL	SPI image write tests.
SPI image	C:\path\to\bin	The first column shows the result of the test. The second columns shows the path to the firmware burnt.
EEPROM init	PASS\FAIL	Initialize EEPROM memory.
EEPROM burn 'X' ['Test Name']	PASS\FAIL	EEPROM image write tests.
EEPROM image	C:\path\to\bin	The first column shows the result of the test. The second columns shows the path to the firmware burnt.
OTP burn	PASS\FAIL	OTP image write test.
OTP image	C:\path\to\bin	The first column shows the result of the test. The second columns shows the path to the firmware burnt.
OTP BDA burn	PASS\FAIL	Write BD address value to OTP Header.
OTP BDA rd/cmp	PASS\FAIL	Read BD address written in OTP Header and compare it with the one the device is currently using.
OTP BDA read	XX:XX:XX:XX:XX:X X	The first column shows the result of the test. The second columns shows the BD address written in the OTP header.
OTP XTAL trim burn	PASS\FAIL	Write XTAL Trim value to OTP Header.
OTP header burn	PASS\FAIL	OTP Header area burn.
OTP write ADC calibration	PASS\FAIL	Write ADC calibration value to OTP.
Scan	PASS\FAIL	Scan test with the DUTs booting and advertising.

DA1458x/DA1468x Production Line Tool**CSV Log File Example**

This example uses three DA14583 devices. The following tests and memory operations are enabled:

- XTAL Trim
- GPIO Watchdog Operation
- Scan DUT Advertise Test
- Golden Unit - RF Test 1
- Golden Unit - RF Test 2
- BLE Tester - Tx Power 1
- BLE Tester - Frequency Offset 1
- BLE Tester - Modulation Index 1
- BLE Tester - Rx Sensitivity 1
- GPIO\LED Test 1
- Custom Test 1
- External 32kHz Test
- Current Measurement Test - Peripheral Test 1
- Current Measurement Test - Extended Sleep Test
- SPI Erase 1
- SPI Check Empty 1
- SPI Write 1
- Custom Memory Data - Manual
- OTP BD Address Read
- Memory Read Test 1
- Scan Test

The first device successfully completed all tests, the second failed to be found by the Golden Unit during the scan test and the third failed the external 32kHz test.

The CSV results of the tests are split into four main categories explained in detailed in the following chapters.

DA1458x/DA1468x Production Line Tool

CSV Log File Entries 1/4

The first part of the CSV file contains general device and test information, as shown in [Figure 179](#) and explained in [Table 135](#).

Start time	End time	DUT	BD address	Overall status	COM port
15:05:55	15:06:54	1	80:80:80:00:00:0A	PASS	44
15:05:55	15:06:54	2	80:80:80:00:00:0B	FAIL	45
15:05:55	15:06:54	3	80:80:80:00:00:0C	FAIL	46

Figure 179: CSV File Entries (1/4)

Table 135: CSV File Entries (1/4).

Header	Value	Description
Start time	15:05:55	The time the tests started.
End time	15:06:54	The time the tests finished.
DUT	1 2 3	The PLT position each device is connected.
BD address	80:80:80:00:00:0A 80:80:80:00:00:0B 80:80:80:00:00:0C	The BD address assigned to each device.
Overall status	PASS FAIL FAIL	The overall final result for each device.
COM port	44 45 46	The Windows assigned COM port to each device.

UM-B-041

DA1458x/DA1468x Production Line Tool

CSV Log File Entries 2/4

The second part of the CSV Log file contains the production tests entries, as shown in [Figure 180](#) and explained in [Table 136](#).

FW download 1	FW path 1	FW version get 1	FW version 1	GPIO Watchdog [WD-P1_0]	XTAL trim test	XTAL trim	Scan HCI Adv [CH37]	Scan HCI Adv RSSI [CH37]
PASS	C:\DA1458x_DA1468x_PLT_v_4.x\executables\binaries\prod_test_580.bin	PASS	v_5.0.4_PLT_v4.3	PASS	PASS	1266	PASS	-11.39
PASS	C:\DA1458x_DA1468x_PLT_v_4.x\executables\binaries\prod_test_580.bin	PASS	v_5.0.4_PLT_v4.3	PASS	PASS	1237	PASS	-14.71
PASS	C:\DA1458x_DA1468x_PLT_v_4.x\executables\binaries\prod_test_580.bin	PASS	v_5.0.4_PLT_v4.3	PASS	PASS	1155	PASS	-16.61

BLE TX power test 1 [Tx Pwr 1]	BLE TX power 1 [Tx Pwr 1]	BLE TX offset test 1 [Freq Offs 1]	BLE TX offset 1 [Freq Offs 1]
PASS	TRUE;-17.91;-17.91;-17.91;0.10;0;2;PASS	PASS	TRUE;-2.500e+003;2.800e+003;-7.800e+003;-7646;-9.0e+003;-9.0e+003;0;2;PASS;-7646
PASS	TRUE;-9.63;-9.63;-9.63;0.09;0;2;PASS	PASS	TRUE;-1.500e+003;3.200e+003;-6.800e+003;5945;-6.0e+003;-6.0e+003;0;2;PASS;-1054
PASS	TRUE;-12.27;-12.27;-12.27;0.09;0;2;PASS	PASS	TRUE;4.000e+002;5.900e+003;-3.700e+003;-6009;-8.0e+003;-8.0e+003;0;2;PASS;1756

BLE TX modulation test 1 [Mod Idx 1]	BLE TX modulation 1 [Mod Idx 1]	BLE RX RSSI test 1 [Rx sens 1]	BLE RX RSSI 1 [Rx sens 1]	BLE RX PER 1 [Rx sens 1]
PASS	TRUE;282100.00;249100.00;200700.00;248700.00;1.00;0;576;1;1;FAIL;100.00%	PASS		-18.03
PASS	TRUE;276800.00;248800.00;190600.00;238200.00;0.96;0;576;1;1;FAIL;100.00%	PASS		-11.87
PASS	TRUE;261800.00;246400.00;199400.00;238700.00;0.97;0;576;1;1;FAIL;100.00%	PASS		-13.29

GU RX RSSI test 1 [GU_RSSI_1]	GU RX RSSI 1 [GU_RSSI_1]	GU RX PER 1 [GU_RSSI_1]	GU RX RSSI test 2 [GU_RSSI_2]	GU RX RSSI 2 [GU_RSSI_2]	GU RX PER 2 [GU_RSSI_2]	GPIO/LED test 1 [GPIO_P1_0]
PASS		-11.87	3.2	PASS		-11.87
PASS		-15.18	0	PASS		-15.66
PASS		-15.66	0.4	PASS		-15.66

Custom test 1	32KHz Test	Peripheral test 1	Peripheral test current 1	Extended sleep current test	Extended sleep current
PASS	PASS	PASS	RES=[0.007038353A]. LL=[0.0000020000A]. HL=[0.2000000000A].	PASS	RES=[0.001338430A]. LL=[0.0000340000A]. HL=[0.0400000000A].
PASS	PASS	PASS	RES=[0.007038353A]. LL=[0.0000020000A]. HL=[0.2000000000A].	PASS	RES=[0.001338430A]. LL=[0.0000340000A]. HL=[0.0400000000A].
PASS	FAIL				

Figure 180: CSV File Entries (2/4)

Table 136: CSV File Entries (2/4).

Header	Value	Description
FW download 1	PASS	Production test firmware downloaded successfully to all devices. Selected firmware is C:\DA1458x_DA1468x_PLT_v_4.x\executables\binaries\prod_test_580.bin.
FW path 1	C:\DA1458x_DA1468x_PLT_v_4.x\executables\binaries\prod_test_580.bin	

UM-B-041

DA1458x/DA1468x Production Line Tool

Header	Value	Description
FW version get 1	PASS	All devices responded to firmware version request. All of them have version v_5.0.4_PLT_v4.3.
FW version 1	v_5.0.4_PLT_v4.3	
GPIO watchdog [WD-P1_0]	PASS	GPIO toggling for watchdog has started. In addition, header has the name assigned to the test.
XTAL Trim test	PASS	XTAL Trim test finished successfully. The calculated value (in decimal) is shown for each device.
XTAL Trim	1266	
	1237	
	1155	
Scan HCI Adv [CH37]	PASS	Scan test using advertising through HCI commands test finished successfully. Channel 37 is selected, which is also shown on the header. RSSI values, for each device are also shown.
Scan HCI Adv RSSI [CH37]	-11.39	
	-14.71	
	-16.61	
BLE TX power test 1 [Tx Pwr 1]	PASS	Transmission power test using external BLE Tester finished successfully. In addition, header has the name assigned to the test and the BLE tester values are shown exactly as they were retrieved.
BLE TX power 1 [Tx Pwr 1]	TRUE;-14.25;-14.25;-14.25;0.10;0;2;PASS	
	TRUE;-19.89;-19.89;-19.89;0.13;0;2;PASS	
	TRUE;-9.76;-9.76;-9.76;0.08;0;2;PASS	
BLE TX offset test 1 [Freq Offs 1]	PASS	Transmission offset test using external BLE Tester finished successfully. In addition, header has the name assigned to the test and the BLE tester values are shown exactly as they were retrieved.
BLE TX offset 1 [Freq Offs 1]	TRUE;-2.500e+003;2.800e+003;-7.800e+003;-7646;-9.0e+003;-9.0e+003;0;2;PASS;-7646	
	TRUE;-1.500e+003;3.200e+003;-6.800e+003;5945;-6.0e+003;-6.0e+003;0;2;PASS;-1054	
	TRUE;4.000e+002;5.900e+003;-3.700e+003;-6009;-8.0e+003;-8.0e+003;0;2;PASS;1756	
BLE TX modulation test 1 [Mod Idx 1]	PASS	Transmission modulation index test using external BLE Tester finished successfully. In addition, header has the name assigned to the test and the BLE tester values are

UM-B-041

DA1458x/DA1468x Production Line Tool

Header	Value	Description
BLE TX modulation 1 [Mod Idx 1]	TRUE;282100.00;249100.00;200700.00;248700.00;1.00;0;576;1;1;FAIL;100.00% TRUE;276800.00;248800.00;190600.00;238200.00;0.96;0;576;1;1;FAIL;100.00% TRUE;261800.00;246400.00;199400.00;238700.00;0.97;0;576;1;1;FAIL;100.00%	shown exactly as they were retrieved.
BLE RX RSSI test 1 [Rx sens 1]	PASS	Reception test using external BLE Tester finished successfully. In addition, header has the name assigned to the test and the RSSI and packet error rate for each device are shown.
BLE RX RSSI 1 [Rx sens 1]	-18.03 -11.87 -13.29	
BLE RX PER 1 [Rx sens 1]	4 5.6 0.4	
GU RX RSSI test 1 [GU_RSSI_1]	PASS	Reception test 1 using the Golden Unit finished successfully. In addition, header has the name assigned to the test and the RSSI and packet error rate for each device are shown.
GU RX RSSI 1 [GU_RSSI_1]	-11.87 -15.18 -15.66	
GU RX PER 1 [GU_RSSI_1]	3.2 0 0.4	
GU RX RSSI test 2 [GU_RSSI_2]	PASS	Reception test 2 using the Golden Unit finished successfully. In addition, header has the name assigned to the test and the RSSI and packet error rate for each device are shown.
GU RX RSSI 2 [GU_RSSI_2]	-11.87 -15.66 -15.66	

UM-B-041

DA1458x/DA1468x Production Line Tool

Header	Value	Description
GU RX PER 2 [GU_RSSI_2]	7.6 1.2 0.8	
GPIO/LED test 1 [GPIO_P1_0]	PASS	GPIOLED toggling test finished successfully.
Custom test 1	PASS	Custom test finished successfully.
External 32kHz test	Devices 1-2: PASS Device 3: FAIL	External 32kHz test finished successfully for devices 1 and 2. In this test, device #3 failed . Since device 3 failed on this test, it will not continue with the remaining tests, meaning that the entries for device 3 will be blank.
Peripheral test 1	PASS	Current measurement for peripherals test finished successfully. Only one test was active. The limits used and the value measured are shown. These values are for all active devices, in this case for two devices, devices 1 and 2.
Peripheral test current 1	RES=[0.007038353A]. LL=[0.0000020000A]. HL=[0.2000000000A]. RES=[0.007038353A]. LL=[0.0000020000A]. HL=[0.2000000000A].	
Extended sleep current test	PASS	Current measurement during extended sleep test finished successfully. The limits used and the value measured are shown. These values are for all active devices, in this case for two devices, devices 1 and 2.
Extended sleep current	RES=[0.001338430A]. LL=[0.0000340000A]. HL=[0.0400000000A]. RES=[0.001338430A]. LL=[0.0000340000A]. HL=[0.0400000000A].	

UM-B-041

DA1458x/DA1468x Production Line Tool

CSV Log File Entries 3/4

The third part of the CSV Log file contains the memory programming entries, as shown in [Figure 181](#) and explained in [Table 137](#).

FW download 2	FW path 2	FW version get 2	FW version 2	GPIO Watchdog mem [WD-P1_0]	SPI init	SPI erase 1 [SPI ER 1]	SPI empty 1 [SPI ER 1]
PASS	C:\DA1458x_DA1468x_PLT_v_4.x\executables\binaries\flash_programmer_580.bin	PASS	v_5.0.4_PLT_v4.3	PASS	PASS	PASS	PASS
PASS	C:\DA1458x_DA1468x_PLT_v_4.x\executables\binaries\flash_programmer_580.bin	PASS	v_5.0.4_PLT_v4.3	PASS	PASS	PASS	PASS
SPI burn 1 [SPI WR 1]	SPI image 1 [SPI WR 1]	Custom memory burn	Custom memory data	OTP BDA rd/cmp	OTP BDA read	SPI Memory read 1 [SPI @8000]	SPI Memory read data 1 [SPI @8000]
PASS	binaries\prox_reporter_580.bin	PASS	1122334455	PASS	80:80:80:00:00:0A	PASS	1122334455
PASS	binaries\prox_reporter_580.bin	PASS	1122334455	FAIL	00:00:00:00:00:00		

Figure 181: CSV File Entries (3/4)

Table 137: CSV File Entries (3/4).

Header	Value	Description
FW download 2	PASS	Production test firmware downloaded successfully to all devices. Selected firmware is C:\DA1458x_DA1468x_PLT_v_4.x\executables\binaries\prod_test_580.bin.
FW path 2	C:\DA1458x_DA1468x_PLT_v_4.x\executables\binaries\prod_test_580.bin	
FW version get 2	PASS	All devices responded to firmware version request. All of them have version v_5.0.4_PLT_v4.3.
FW version 2	v_5.0.4_PLT_v4.3	
GPIO watchdog [WD-P1_0]	PASS	GPIO toggling for watchdog has started. In addition, header has the name assigned to the test.
SPI init	PASS	SPI flash initialization procedure completed successfully.
SPI erase 1 [SPI ER 1]	PASS	SPI flash erase procedure completed successfully. Only one test is active. In addition, header has the name assigned to the test.
SPI empty 1 [SPI ER 1]	PASS	SPI flash check for empty contents procedure completed successfully. Only one test is active. In addition, header has the name assigned to the test.
SPI burn 1 [SPI WR 1]	PASS	Production test firmware downloaded successfully to all devices. Selected firmware

UM-B-041

DA1458x/DA1468x Production Line Tool

Header	Value	Description
SPI image 1 [SPI WR 1]	binaries\prox_reporter_580.bin binaries\prox_reporter_580.bin	is C:\DA1458x_DA1468x_PLT_v_4.x\executables\binaries\prod_test_580.bin.
Custom memory burn	PASS	Custom memory data write procedure completed successfully. Data written were 1122334455.
Custom memory data	1122334455 1122334455	
OTP BDA rd/cmp	Device 1: PASS Device 2: FAIL	OTP read and compared test completed successfully for both devices, but the contents of device 2 did not match the assigned BD address, resulting to failure for device 2. Assigned BD address for device 2 was 80:80:80:00:00:0B and the contents of the OTP header were 00:00:00:00:00:00. Device1 BD address assigned and OTP header contents were both 80:80:80:00:00:0A. Since device 2 failed on this test, it will not continue with the remaining tests, meaning that the entries for device 2 will be blank.
OTP BDA read	80:80:80:00:00:0A 00:00:00:00:00:00	
SPI Memory read 1 [SPI @8000]	PASS	Read data from SPI Flash memory completed successfully. Only one test was active. Data read back were 1122334455. The memory and address are the as those in Custom memory write, resulting to same contents. In addition, header has the name assigned to the test.
SPI Memory read data 1 [SPI @8000]	1122334455	

UM-B-041

DA1458x/DA1468x Production Line Tool

CSV Log File Entries 4/4

The last part of the CSV Log file contains the scan test entry, as shown in [Figure 182](#) and explained in [Table 138](#).

Scan
PASS

Figure 182: CSV File Entries (4/4)

Table 138: CSV File Entries (4/4).

Header	Value	Description
Scan	PASS	Scan test for device 1 has finished successfully.

Appendix Z DUT Status Codes

Table 139 contains all the possible status codes a DUT can have, followed by a brief description. The table categorizes the status based on the various states of the DUT during testing and programming.

Table 139: DUT Status Codes

Status	Description
Generic	
DUT_NOT_ACTIVE	Device is not active.
DUT_INTERNAL_SYSTEM_ERROR	Internal system error.
DUT_COM_PORT_IDENTIFY_STARTED	COM port identification started.
DUT_COM_PORT_IDENTIFY_OK	COM port identified successfully.
DUT_COM_PORT_IDENTIFY_FAILED	COM port identification failed.
DUT_GU_ERROR	Error occurred due to a Golden Unit failure. Check the Golden unit status for more information.
COM port enumeration	
DUT_PDLL_UART_LOOP_INIT	UART loop test initialized.
DUT_PDLL_UART_LOOP_START	UART loop test start.
DUT_PDLL_UART_LOOP_OK	UART loop test ended successfully.
DUT_PDLL_UART_LOOP_FAILED	UART loop test failed.
Temperature measurement	
DUT_TEMPERATURE_MEASUREMENT_INIT	Temperature measurement initialized.
DUT_TEMPERATURE_MEASUREMENT_OK	Temperature measurement finished successfully.
DUT_TEMPERATURE_MEASUREMENT_ERROR	Temperature measurement error.
Production test - Generic errors	
DUT_PDLL_NO_ERROR	PDLL returned success.
DUT_PDLL_PARAMS_ERROR	PDLL Device parameters contain errors.
DUT_PDLL_RX_TIMEOUT	Device did not reply on a PDLL message request.
DUT_PDLL_TX_TIMEOUT	Sending a message to the device failed due to Tx timeout.
DUT_PDLL_UNEXPECTED_EVENT	Received an unexpected message from the device.
DUT_PDLL_CANNOT_ALLOCATE_MEMORY	PDLL cannot allocate memory.
DUT_PDLL_INTERNAL_ERROR	PDLL internal system error.
DUT_PDLL_THREAD_CREATION_ERROR	PDLL thread creation error.
DUT_PDLL_INVALID_DBG_PARAMS	PDLL debug library (dbg_dll.dll) access error.
DUT_PDLL_DBG_DLL_ERROR	PDLL invalid debug library (dbg_dll.dll) parameters.
DUT_PDLL_HCI_STANDARD_ERROR	HCI error.
Production test - COM port	
DUT_PDLL_COM_PORT_INIT	PDLL Device COM port open initialized.
DUT_PDLL_COM_PORT_START	PDLL Device COM port open started.
DUT_PDLL_COM_PORT_OK	PDLL Device COM port opened successfully.

DA1458x/DA1468x Production Line Tool

Status	Description
DUT_PDLL_COM_PORT_FAILED	PDLL Device COM port failed.
Production test - UART resync	
DUT_PDLL_UART_RESYNC_INIT	UART resync process initialized.
DUT_PDLL_UART_RESYNC_START	UART resync process started.
DUT_PDLL_UART_RESYNC_OK	UART resync process completed successfully.
DUT_PDLL_UART_RESYNC_FAILED	UART resync process failed.
Production test - Firmware version	
DUT_PDLL_FW_VERSION_GET_START	PDLL Device Firmware version acquisition started.
DUT_PDLL_FW_VERSION_GET_OK	PDLL Device Firmware version acquisition completed successfully.
DUT_PDLL_FW_VERSION_GET_FAILED	PDLL Device Firmware version acquisition failed.
Production test – GPIO Watchdog	
DUT_PDLL_GPIO_WD_INIT	GPIO watchdog operation initialized.
DUT_PDLL_GPIO_WD_START	GPIO watchdog operation started.
DUT_PDLL_GPIO_WD_OK	GPIO watchdog operation ended successfully.
DUT_PDLL_GPIO_WD_FAILED	GPIO watchdog operation failed.
Production test - Current measurement test	
DUT_SLEEP_CURRENT_MEASURE_INIT	Sleep current measurement test initialized.
DUT_SLEEP_CURRENT_MEASURE_START	Sleep current measurement test start.
DUT_SLEEP_DEVICE_SLEPT_OK	Sleep current measurement device mode set successfully.
DUT_SLEEP_CURRENT_MEASURE_ERROR	Sleep current measurement test error.
DUT_SLEEP_CURRENT_MEASURE_PASSED	Sleep current measurement test passed.
DUT_SLEEP_CURRENT_MEASURE_FAILED	Sleep current measurement test failed.
DUT_PDLL_PERIPH_AMMETER_TEST_INIT	Peripheral current measurement test initialized.
DUT_PDLL_PERIPH_AMMETER_TEST_START	Peripheral current measurement test start.
DUT_PDLL_PERIPH_AMMETER_TEST_ERROR	Peripheral current measurement test error.
DUT_PDLL_PERIPH_AMMETER_TEST_PASSED	Peripheral current measurement test passed.
DUT_PDLL_PERIPH_AMMETER_TEST_FAILED	Peripheral current measurement test failed.
Production test – Sleep Clock Source	
DUT_PDLL_SLEEP_CLK_SRC_INIT	Sleep Clock source test operation initialized.
DUT_PDLL_SLEEP_CLK_SRC_START	Sleep Clock source test operation started.
DUT_PDLL_SLEEP_CLK_SRC_OK	Sleep Clock source test operation ended successfully.
DUT_PDLL_SLEEP_CLK_SRC_FAILED	Sleep Clock source test operation failed.
Production test – External 32 kHz	
DUT_PDLL_EXT32KHz_TEST_INIT	External 32kHz test operation initialized.
DUT_PDLL_EXT32KHz_TEST_START	External 32kHz test operation started.
DUT_PDLL_EXT32KHz_TEST_OK	External 32kHz test operation ended successfully.
DUT_PDLL_EXT32KHz_TEST_FAILED	External 32kHz test operation failed.

DA1458x/DA1468x Production Line Tool

Status	Description
Production test - XTAL trim	
Xtal trim test	
DUT_PDLL_XTAL_TRIM_INIT	XTAL trim operation initialized.
DUT_PDLL_XTAL_TRIM_START	XTAL trim operation started.
DUT_PDLL_XTAL_TRIM_OK	XTAL trim operation ended successfully.
DUT_PDLL_XTAL_TRIM_OUT_OF_RANGE	XTAL trim failed. Input frequency is out of range.
DUT_PDLL_XTAL_TRIM_FREQ_CAL_NOT_CONNECTED	XTAL trim could not be performed. Could not detect external input frequency.
DUT_PDLL_XTAL_TRIM_OTP_WRITE_FAILED	XTAL trim failed. Could not write the calculated value to the OTP header.
DUT_PDLL_XTAL_TRIM_FAILED	XTAL trim failed.
Read value written in OTP	
DUT_PDLL_OTP_XTAL_TRIM_READ_INIT	OTP XTAL trim read operation initialized.
DUT_PDLL_OTP_XTAL_TRIM_READ_START	OTP XTAL trim read operation started.
DUT_PDLL_OTP_XTAL_TRIM_READ_OK	OTP XTAL trim read operation ended successfully.
DUT_PDLL_OTP_XTAL_TRIM_READ_FAILED	OTP XTAL trim read operation failed.
Read register value	
DUT_PDLL_XTAL_TRIM_READ_INIT	XTAL trim value read initialized.
DUT_PDLL_XTAL_TRIM_READ_START	XTAL trim value read started.
DUT_PDLL_XTAL_TRIM_READ_OK	XTAL trim value read success.
DUT_PDLL_XTAL_TRIM_READ_FAILED	XTAL trim value read failed.
Production test - Golden Unit	
Rf test	
DUT_PDLL_GU_RF_RX_TEST_PASSED	Golden Unit RF RX packet test passed.
DUT_PDLL_GU_RF_RX_TEST_FAILED	Golden Unit RF RX packet test failed.
DUT start packet Rx	
DUT_PDLL_PKT_RX_STATS_START_INIT	RF RX packet test with statistics start initialized.
DUT_PDLL_PKT_RX_STATS_START	RF RX packet test with statistics start.
DUT_PDLL_PKT_RX_STATS_STARTED_OK	RF RX packet test with statistics started successfully.
DUT_PDLL_PKT_RX_STATS_START_FAILED	RF RX packet test with statistics started failed.
DUT stop packet Rx	
DUT_PDLL_PKT_RX_STATS_STOP_INIT	RF RX packet test with statistics stop initialized.
DUT_PDLL_PKT_RX_STATS_STOP_START	RF RX packet test with statistics stop.
DUT_PDLL_PKT_RX_STATS_STOPPED_OK	RF RX packet test with statistics stopped successfully.
DUT_PDLL_PKT_RX_STATS_STOP_FAILED	RF RX packet test with statistics stop failed.
Production test - BLE tester	
Tx power measurement	
DUT_BLE_TESTER_TX_PWR_PASSED	BLE tester TX power test passed.
DUT_BLE_TESTER_TX_PWR_FAILED	BLE tester TX power test failed.

DA1458x/DA1468x Production Line Tool

Status	Description
Tx carrier offset measure	
DUT_BLE_TESTER_TX_OFFSETS_PASSED	BLE tester TX frequency offset test passed.
DUT_BLE_TESTER_TX_OFFSETS_FAILED	BLE tester TX frequency offset test failed.
Tx modulation index measure	
DUT_BLE_TESTER_TX_MOD_IDX_PASSED	BLE tester TX modulation index test passed.
DUT_BLE_TESTER_TX_MOD_IDX_FAILED	BLE tester TX modulation index test failed.
Rx sensitivity test	
DUT_BLE_TESTER_RX_TEST_PASSED	BLE tester RX sensitivity test passed.
DUT_BLE_TESTER_RX_TEST_FAILED	BLE tester RX sensitivity test failed.
DUT packet transaction	
DUT_PDLL_PKT_TX_START_INIT	RF packet TX initialized.
DUT_PDLL_PKT_TX_START	RF packet TX start.
DUT_PDLL_PKT_TX_STARTED_OK	RF packet TX started successfully.
DUT_PDLL_PKT_TX_STARTED_FAILED	RF packet TX failed to start.
DUT_PDLL_PKT_TX_ENDED_START	RF packet TX ended successfully.
DUT_PDLL_PKT_TX_ENDED_OK	RF packet TX end initiated.
DUT_PDLL_PKT_TX_ENDED_FAILED	RF packet TX failed to end.
Production test - Scan With HCI BLE Advertisements test	
DUT_PDLL_BLE_HCI_ADV_START_INIT	BLE HCI advertise start initialized.
DUT_PDLL_BLE_HCI_ADV_START	BLE HCI advertise start started.
DUT_PDLL_BLE_HCI_ADV_START_OK	BLE HCI advertise start success.
DUT_PDLL_BLE_HCI_ADV_START_FAILED	BLE HCI advertise start failed.
DUT_PDLL_BLE_HCI_ADV_STOP_INIT	BLE HCI advertise stop initialized.
DUT_PDLL_BLE_HCI_ADV_STOP_START	BLE HCI advertise stop started.
DUT_PDLL_BLE_HCI_ADV_STOPPED_OK	BLE HCI advertise stop success.
DUT_PDLL_BLE_HCI_ADV_STOP_FAILED	BLE HCI advertise stop failed.
DUT_PDLL_BLE_HCI_ADV_SCAN_START	BLE HCI advertise scan started.
DUT_PDLL_BLE_HCI_ADV_NOT_YET_FOUND	BLE HCI advertise not yet found.
DUT_PDLL_BLE_HCI_ADV_FOUND	BLE HCI advertise found.
DUT_PDLL_BLE_HCI_ADV_RSSI_FAILED	BLE HCI advertise RSSI failed.
DUT_PDLL_BLE_HCI_ADV_FAILED	BLE HCI advertise failed.
Production test – Range Extender test	
DUT_PDLL_RANGE_EXT_EN_INIT	Range extender test enable initialization.
DUT_PDLL_RANGE_EXT_EN_START	Range extender test enable start.
DUT_PDLL_RANGE_EXT_EN_ERROR	Range extender test enable error.
DUT_PDLL_RANGE_EXT_EN_OK	Range extender test enable ended successfully.
DUT_PDLL_RANGE_EXT_EN_FAILED	Range extender test enable failed.
Production test - GPIO/LED test	
DUT_PDLL_GPIO_TOGGLE_INIT	GPIO-LED test operation initialized.

DA1458x/DA1468x Production Line Tool

Status	Description
DUT_PDLL_GPIO_TOGGLE_START	GPIO-LED test operation start.
DUT_PDLL_GPIO_TOGGLE_FINISHED_OK	GPIO-LED test operation completed successfully.
DUT_PDLL_GPIO_TOGGLE_ERROR	GPIO-LED test operation error.
DUT_PDLL_GPIO_TOGGLE_FAILED	GPIO-LED test operation failed.
DUT_PDLL_GPIO_TOGGLE_PASSED	GPIO-LED test operation passed.
Production test – GPIO Connection test	
DUT_PDLL_GPIO_CONNECTION_INIT	GPIO Connection test operation initialized.
DUT_PDLL_GPIO_SET_START	GPIO Connection test set operation start.
DUT_PDLL_GPIO_SET_ERROR	GPIO Connection test set operation error.
DUT_PDLL_GPIO_SET_FINISHED_OK	GPIO Connection test set operation success.
DUT_PDLL_GPIO_GET_START	GPIO Connection test get operation start.
DUT_PDLL_GPIO_GET_ERROR	GPIO Connection test get operation passed.
DUT_PDLL_GPIO_GET_FINISHED_OK	GPIO Connection test get operation success.
DUT_PDLL_GPIO_CONNECTION_ERROR	GPIO Connection test operation error.
DUT_PDLL_GPIO_CONNECTION_FAILED	GPIO Connection test operation failed.
DUT_PDLL_GPIO_CONNECTION_PASSED	GPIO Connection test operation completed successfully.
Production test - Audio test	
DUT_PDLL_AUDIO_TEST_START_INIT	Audio test start action initialized.
DUT_PDLL_AUDIO_TEST_START	Audio test action start.
DUT_PDLL_AUDIO_TEST_ALREADY_ACTIVE	Audio test is already active.
DUT_PDLL_AUDIO_TEST_STARTED_OK	Audio test action started successfully.
DUT_PDLL_AUDIO_TEST_START_FAILED	Audio test start action failed.
DUT_PDLL_AUDIO_TEST_STOP_INIT	Audio test stop action initialized.
DUT_PDLL_AUDIO_TEST_STOP	Audio test stop action started.
DUT_PDLL_AUDIO_TEST_STOPPED_OK	Audio test stop action completed successfully.
DUT_PDLL_AUDIO_TEST_STOP_FAILED	Audio test stop action failed.
DUT_PDLL_AUDIO_TEST_PASSED	Audio test passed.
DUT_PDLL_AUDIO_TEST_FAILED	Audio test failed.
DUT_PDLL_AUDIO_TEST_INVALID_COMMAND	Audio test invalid command.
Production test - Sensor test	
DUT_PDLL_SENSOR_TEST_INIT	Sensor test action initialized.
DUT_PDLL_SENSOR_TEST_START	Sensor test action start.
DUT_PDLL_SENSOR_TEST_OK	Sensor test action ended successfully.
DUT_PDLL_SENSOR_TEST_FAILED	Sensor test action failed.
DUT_PDLL_SENSOR_TEST_DATA_MATCH_OK	Sensor test action data matched.
DUT_PDLL_SENSOR_TEST_DATA_MATCH_FAILED	Sensor test action data match failure.
Production test - Custom action test	
DUT_PDLL_CUSTOM_ACTION_INIT	Custom test action initialized.

DA1458x/DA1468x Production Line Tool

Status	Description
DUT_PDLL_CUSTOM_ACTION_START	Custom test action start.
DUT_PDLL_CUSTOM_ACTION_OK	Custom test action ended successfully.
DUT_PDLL_CUSTOM_ACTION_FAILED	Custom test action failed.
DUT_PDLL_CUSTOM_ACTION_DATA_MATCH_OK	Custom test action data matched.
DUT_PDLL_CUSTOM_ACTION_DATA_MATCH_FAILED	Custom test action data match failure.
Production test - ADC calibration test	
DUT_PDLL_ADC_CALIB_INIT	ADC calibration process. Initializing process.
DUT_PDLL_ADC_CALIB_VBAT_RD_START	ADC calibration process. Start reading VBAT voltage using the external voltage meter instrument.
DUT_PDLL_ADC_CALIB_VBAT_RD_OK	ADC calibration process. VBAT voltage read ended successfully.
DUT_PDLL_ADC_CALIB_VBAT_RD_FAILED	ADC calibration process. VBAT voltage read failed.
DUT_PDLL_ADC_CALIB_DUT_RD_INIT	ADC calibration process. Initialize reading device ADC samples.
DUT_PDLL_ADC_CALIB_DUT_RD_START	ADC calibration process. Start reading device ADC samples.
DUT_PDLL_ADC_CALIB_DUT_RD_OK	ADC calibration process. Device ADC samples read success.
DUT_PDLL_ADC_CALIB_DUT_RD_FAILED	ADC calibration process. Device ADC samples read failed.
DUT_PDLL_ADC_CALIB_OK	ADC calibration process ended successfully.
DUT_PDLL_ADC_CALIB_FAILED	ADC calibration process failed.
Production test - Scan test	
DUT_PDLL_BLE_SCAN_INIT	Scan operation initialized.
DUT_PDLL_BLE_SCAN_START	Scan operation start.
DUT_PDLL_BLE_SCAN_NOT_YET_FOUND	Scan operation. DUT has not been found yet.
DUT_PDLL_BLE_SCAN_FOUND	Scan operation completed successfully. DUT was found.
DUT_PDLL_BLE_SCAN_FAILED	Scan operation failed. DUT was not found.
Memory programming - Generic errors	
DUT_UDLL_SUCCESS	UDLL returned success.
DUT_UDLL_ACTION_RESPONSE_ERROR	UDLL device responded with error.
DUT_UDLL_UART_RX_TIMEOUT_ERROR	UDLL UART RX timeout. Cannot communicate with the DUT or DUT is not present.
DUT_UDLL_NO_CRC_MATCH_ERROR	UDLL CRC match error.
DUT_UDLL_PROG_PARAMS_ERROR	UDLL programming parameter error.
DUT_UDLL_DEVICE_PARAMS_ERROR	UDLL device parameter error.
DUT_UDLL_UART_WRITE_ERROR	UDLL UART write returned error.
DUT_UDLL_UART_READ_ERROR	UDLL UART read returned error.
DUT_UDLL_INTERNAL_ERROR	UDLL internal error.
DUT_UDLL_COM_PORT_INIT_ERROR	UDLL COM port initialization error.
DUT_UDLL_COM_PORT_ERROR	UDLL COM port error.

DA1458x/DA1468x Production Line Tool

Status	Description
DUT_UDLL_CANNOT_ALLOCATE_MEMORY	UDLL cannot allocate memory.
DUT_UDLL_READ_FILE_SIZE_ERROR	UDLL read file size error.
DUT_UDLL_CANNOT_OPEN_FW_FILE	UDLL cannot open firmware file.
DUT_UDLL_CANNOT_OPEN_IMAGE_FILE	UDLL cannot open image file.
DUT_UDLL_UART_PINS_PATCH_ERROR	UDLL cannot patch the UART pins into the firmware file.
DUT_UDLL_INVALID_DBG_PARAMS	UDLL invalid debug library (dbg_dll.dll) parameters.
DUT_UDLL_DBG_DLL_ERROR	UDLL debug library (dbg_dll.dll) access error.
Firmware download	
DUT_UDLL_FW_DOWNLOAD_INIT	UDLL firmware download initialized.
DUT_UDLL_FW_DOWNLOAD_STARTED	UDLL firmware download started successfully.
DUT_UDLL_FW_DOWNLOAD_RETRY	UDLL firmware download retry.
DUT_UDLL_FW_DOWNLOAD_OK	UDLL firmware downloaded successfully.
DUT_UDLL_FW_DOWNLOAD_FAILED	UDLL firmware download failed.
Memory programming - Firmware version	
DUT_UDLL_FW_VER_GET_INIT	UDLL Device Firmware version acquisition initialized
DUT_UDLL_FW_VER_GET_STARTED	UDLL Device Firmware version acquisition started.
DUT_UDLL_FW_VER_GET_OK	UDLL Device Firmware version acquisition completed successfully.
DUT_UDLL_FW_VER_GET_FAILED	UDLL Device Firmware version acquisition failed.
Memory programming – GPIO Watchdog	
DUT_UDLL_GPIO_WD_INIT	UDLL GPIO watchdog operation initialized.
DUT_UDLL_GPIO_WD_START	UDLL GPIO watchdog operation started.
DUT_UDLL_GPIO_WD_OK	UDLL GPIO watchdog operation ended successfully.
DUT_UDLL_GPIO_WD_FAILED	UDLL GPIO watchdog operation failed.
Memory programming – RAM Firmware Download	
DUT_UDLL_RAM_FW_DOWNLOAD_INIT	UDLL Firmware download to RAM initialized
DUT_UDLL_RAM_FW_DOWNLOAD_STARTED	UDLL Firmware download to RAM started.
DUT_UDLL_RAM_FW_DOWNLOAD_OK	UDLL Firmware download to RAM completed successfully.
DUT_UDLL_RAM_FW_DOWNLOAD_FAILED	UDLL Firmware download to RAM failed.
Memory programming - OTP image write	
DUT_UDLL_OTP_IMG_WR_INIT	OTP image write operation initialized.
DUT_UDLL_OTP_IMG_WR_STARTED	OTP image write operation started.
DUT_UDLL_OTP_IMG_WR_OK	OTP image write operation ended successfully.
DUT_UDLL_OTP_IMG_WR_FAILED	OTP image write operation failed.
Memory programming - BD address write to OTP memory	
DUT_UDLL_OTP_BDA_WR_INIT	OTP BD address write operation initialized.
DUT_UDLL_OTP_BDA_WR_STARTED	OTP BD address write operation started.
DUT_UDLL_OTP_BDA_WR_OK	OTP BD address write operation ended successfully.

DA1458x/DA1468x Production Line Tool

Status	Description
DUT_UDLL_OTP_BDA_WR_FAILED	OTP BD address write operation failed.
Memory programming - BD address read/compare to OTP memory	
DUT_UDLL_OTP_BDA_RD_INIT	OTP BD address read operation initialized.
DUT_UDLL_OTP_BDA_RD_STARTED	OTP BD address read operation started.
DUT_UDLL_OTP_BDA_RD_OK	OTP BD address read operation ended successfully.
DUT_UDLL_OTP_BDA_RD_FAILED	OTP BD address read operation failed.
DUT_UDLL_OTP_BDA_CMP_OK	OTP BD address comparison success.
DUT_UDLL_OTP_BDA_CMP_FAILED	OTP BD address comparison failed. No match.
Memory programming - XTAL trim value write to OTP memory	
DUT_UDLL_OTP_XTAL_TRIM_WR_INIT	OTP XTAL trim value write operation initialized.
DUT_UDLL_OTP_XTAL_TRIM_WR_STARTED	OTP XTAL trim value write operation started.
DUT_UDLL_OTP_XTAL_TRIM_WR_OK	OTP XTAL trim value write operation ended successfully.
DUT_UDLL_OTP_XTAL_TRIM_WR_FAILED	OTP XTAL trim value write operation failed.
Memory programming - ADC calibration value write to OTP memory	
DUT_UDLL_OTP_ADC_CALIB_WR_INIT	OTP ADC calibration value write operation initialized.
DUT_UDLL_OTP_ADC_CALIB_WR_STARTED	OTP ADC calibration value write operation started.
DUT_UDLL_OTP_ADC_CALIB_WR_OK	OTP ADC calibration value write operation ended successfully.
DUT_UDLL_OTP_ADC_CALIB_WR_FAILED	OTP ADC calibration value write operation failed.
Memory programming - OTP header write	
DUT_UDLL_OTP_HDR_WR_INIT	OTP header write operation initialized.
DUT_UDLL_OTP_HDR_WR_STARTED	OTP header write operation started.
DUT_UDLL_OTP_HDR_WR_OK	OTP header write operation ended successfully.
DUT_UDLL_OTP_HDR_WR_FAILED	OTP header write operation failed.
Memory programming - OTP memory check-empty operation	
DUT_UDLL_OTP_CHECK_EMPTY_INIT	Operation to check whether the OTP field to burn is empty initialized.
DUT_UDLL_OTP_CHECK_EMPTY_STARTED	Operation to check whether the OTP field to burn is empty started.
DUT_UDLL_OTP_CHECK_EMPTY_OK	The OTP field to burn is empty.
DUT_UDLL_OTP_CHECK_SAME_DATA_OK	The OTP field contains the same data as the ones to burn.
DUT_UDLL_OTP_CHECK_EMPTY_FAILED	The OTP field is already burned with data.
Memory programming - SPI initialization	
DUT_UDLL_SPI_INIT_INIT	SPI initialization operation initialized.
DUT_UDLL_SPI_INIT_STARTED	SPI initialization operation started.
DUT_UDLL_SPI_INIT_OK	SPI initialization operation ended successfully.
DUT_UDLL_SPI_INIT_FAILED	SPI initialization operation failed.
Memory programming - SPI memory erase	
DUT_UDLL_SPI_ERASE_INIT	SPI erase operation initialized.

DA1458x/DA1468x Production Line Tool

Status	Description
DUT_UDLL_SPI_ERASE_STARTED	SPI erase operation started.
DUT_UDLL_SPI_ERASE_OK	SPI erase operation ended successfully.
DUT_UDLL_SPI_ERASE_FAILED	SPI erase operation failed.
Memory programming - SPI memory check empty	
DUT_UDLL_SPI_CHECK_EMPTY_INIT	SPI check if empty operation initialized.
DUT_UDLL_SPI_CHECK_EMPTY_STARTED	SPI check if empty operation started,
DUT_UDLL_SPI_CHECK_EMPTY_OK	SPI check if empty operation ended successfully,
DUT_UDLL_SPI_CHECK_EMPTY_FAILED	SPI check if empty operation failed,
Memory programming - SPI image write	
DUT_UDLL_SPI_IMG_WR_INIT	SPI image write operation initialized.
DUT_UDLL_SPI_IMG_WR_STARTED	SPI image write operation started.
DUT_UDLL_SPI_IMG_WR_OK	SPI image write operation ended successfully.
DUT_UDLL_SPI_IMG_WR_FAILED	SPI image write operation failed.
Memory programming - EEPROM initialization	
DUT_UDLL_EEPROM_INIT_INIT	EEPROM initialization operation initialized.
DUT_UDLL_EEPROM_INIT_STARTED	EEPROM initialization operation started.
DUT_UDLL_EEPROM_INIT_OK	EEPROM initialization operation ended successfully.
DUT_UDLL_EEPROM_INIT_FAILED	EEPROM initialization operation failed.
Memory programming - EEPROM image write	
DUT_UDLL_EEPROM_IMG_WR_INIT	EEPROM image write operation initialized.
DUT_UDLL_EEPROM_IMG_WR_STARTED	EEPROM image write operation started.
DUT_UDLL_EEPROM_IMG_WR_OK	EEPROM image write operation ended successfully.
DUT_UDLL_EEPROM_IMG_WR_FAILED	EEPROM image write operation failed.
Memory programming - QSPI memory initialization	
DUT_UDLL_QSPI_INIT_INIT	QSPI initialization operation initialized.
DUT_UDLL_QSPI_INIT_STARTED	QSPI initialization operation started.
DUT_UDLL_QSPI_INIT_OK	QSPI initialization operation ended successfully.
DUT_UDLL_QSPI_INIT_FAILED	QSPI initialization operation failed.
Memory programming - QSPI memory erase	
DUT_UDLL_QSPI_ERASE_INIT	QSPI erase operation initialized.
DUT_UDLL_QSPI_ERASE_STARTED	QSPI erase operation started.
DUT_UDLL_QSPI_ERASE_OK	QSPI erase operation ended successfully.
DUT_UDLL_QSPI_ERASE_FAILED	QSPI erase operation failed.
Memory programming - QSPI memory check empty	
DUT_UDLL_QSPI_CHECK_EMPTY_INIT	QSPI check if empty operation initialized.
DUT_UDLL_QSPI_CHECK_EMPTY_STARTED	QSPI check if empty operation started.
DUT_UDLL_QSPI_CHECK_EMPTY_OK	QSPI check if empty operation ended successfully.
DUT_UDLL_QSPI_CHECK_EMPTY_FAILED	QSPI check if empty operation failed.

Status	Description
Memory programming - QSPI image write	
DUT_UDLL_QSPI_IMG_WR_INIT	QSPI image write operation initialized.
DUT_UDLL_QSPI_IMG_WR_STARTED	QSPI image write operation started.
DUT_UDLL_QSPI_IMG_WR_OK	QSPI image write operation ended successfully.
DUT_UDLL_QSPI_IMG_WR_FAILED	QSPI image write operation failed.
Memory programming - BD address write to QSPI memory	
DUT_UDLL_QSPI_BDA_WR_INIT	QSPI BD address write operation initialized.
DUT_UDLL_QSPI_BDA_WR_STARTED	QSPI BD address write operation started.
DUT_UDLL_QSPI_BDA_WR_OK	QSPI BD address write operation ended successfully.
DUT_UDLL_QSPI_BDA_WR_FAILED	QSPI BD address write operation failed.
Memory programming - BD address read/compare to QSPI memory	
DUT_UDLL_QSPI_BDA_RD_INIT	QSPI BD address read operation initialized.
DUT_UDLL_QSPI_BDA_RD_STARTED	QSPI BD address read operation started.
DUT_UDLL_QSPI_BDA_RD_OK	QSPI BD address read operation ended successfully.
DUT_UDLL_QSPI_BDA_RD_FAILED	QSPI BD address read operation failed.
DUT_UDLL_QSPI_BDA_CMP_OK	QSPI BD address comparison success.
DUT_UDLL_QSPI_BDA_CMP_FAILED	QSPI BD address comparison failed. No match.
Memory programming - XTAL trim value write to QSPI memory	
DUT_UDLL_QSPI_XTAL_TRIM_WR_INIT	QSPI XTAL trim value write operation initialized.
DUT_UDLL_QSPI_XTAL_TRIM_WR_STARTED	QSPI XTAL trim value write operation started.
DUT_UDLL_QSPI_XTAL_TRIM_WR_OK	QSPI XTAL trim value write operation ended successfully.
DUT_UDLL_QSPI_XTAL_TRIM_WR_FAILED	QSPI XTAL trim value write operation failed.
Memory programming - ADC calibration value write to QSPI memory	
DUT_UDLL_QSPI_ADC_CALIB_WR_INIT	QSPI ADC calibration value write operation initialized.
DUT_UDLL_QSPI_ADC_CALIB_WR_STARTED	QSPI ADC calibration value write operation started.
DUT_UDLL_QSPI_ADC_CALIB_WR_OK	QSPI ADC calibration value write operation ended successfully.
DUT_UDLL_QSPI_ADC_CALIB_WR_FAILED	QSPI ADC calibration value write operation failed.
Memory programming - Custom data memory write	
DUT_UDLL_MEM_DATA_WR_INIT	Custom memory data burn operation initialized.
DUT_UDLL_MEM_DATA_WR_STARTED	Custom memory data burn operation started.
DUT_UDLL_MEM_DATA_WR_OK	Custom memory data burn operation ended successfully.
DUT_UDLL_MEM_DATA_WR_FAILED	Custom memory data burn operation failed.
Memory programming - memory read operation	
DUT_UDLL_MEM_RD_INIT	Memory read operation initialized.
DUT_UDLL_MEM_RD_STARTED	Memory read operation started.
DUT_UDLL_MEM_RD_OK	Memory read operation ended successfully.
DUT_UDLL_MEM_RD_FAILED	Memory read operation failed.

Appendix AA Golden Unit Status Codes

Table 140 contains all the possible status codes the Golden Unit can have, followed by a brief description. The table categorizes the status based on the various states the Golden Unit may be during testing and programming the DUTs.

Table 140: Golden Unit Status Codes

Status	Description
Generic	
GU_NOT_ACTIVE	Golden Unit is not active.
GU_INTERNAL_SYSTEM_ERROR	Internal system error.
GU_COM_OPEN_OK	COM port opened successfully.
GU_COM_OPEN_FAILED	COM port failed to open
GU_PDLL_NO_ERROR	PDLL returned success.
GU_PDLL_PARAMS_ERROR	Golden Unit PDLL parameters have errors.
GU_PDLL_RX_TIMEOUT	Golden Unit did not reply on a PDLL message request. GU COM port may not be correct or it may need manual RESET.
GU_PDLL_TX_TIMEOUT	Golden Unit Tx timeout when sending a message to the device.
GU_PDLL_UNEXPECTED_EVENT	Received an unexpected message from the Golden Unit.
GU_PDLL_CANNOT_ALLOCATE_MEMORY	PDLL cannot allocate memory.
GU_PDLL_INTERNAL_ERROR	PDLL internal system error.
GU_PDLL_THREAD_CREATION_ERROR	PDLL thread creation error.
GU_PDLL_DBG_DLL_ERROR	PDLL debug library (dbg_dll.dll) access error.
GU_PDLL_INVALID_DBG_PARAMS	PDLL invalid debug library (dbg_dll.dll) parameters.
GU_PDLL_HCI_STANDARD_ERROR	Golden Unit HCI error.
Golden Unit reset operation	
GU_RESET_START	Golden Unit HW reset started.
GU_RESET_OK	Golden Unit HW reset OK.
GU_RESET_FAILED	Golden Unit HW reset FAILED.
Golden Unit COM port handling	
GU_PDLL_COM_PORT_INIT	Golden Unit COM port open initialized.
GU_PDLL_COM_PORT_START	Golden Unit COM port open started.
GU_PDLL_COM_PORT_OK	Golden Unit COM port opened OK.
GU_PDLL_COM_PORT_FAILED	Golden Unit COM port FAILED.
Golden Unit firmware version	
GU_PDLL_FW_VERSION_GET_START	Golden Unit PDLL firmware version acquisition started.
GU_PDLL_FW_VERSION_GET_OK	Golden Unit PDLL firmware version acquisition OK.
GU_PDLL_FW_VERSION_GET_FAILED	Golden Unit PDLL firmware version acquisition FAILED.
GU_PDLL_FW_VERSION_VALID	The Golden Unit firmware version is valid.
GU_PDLL_FW_VERSION_NOT_VALID	The Golden Unit firmware version is not valid. An upgrade

DA1458x/DA1468x Production Line Tool

Status	Description
	may be needed.
Golden Unit CPLD control	
GU_PDLL_RDTESTER_INIT	PLT HW tester initializing.
GU_PDLL_RDTESTER_INIT_START	PLT HW tester initialize started.
GU_PDLL_RDTESTER_INIT_OK	PLT HW tester initialized successful.
GU_PDLL_RDTESTER_INIT_FAILED	PLT HW tester initialization failed.
GU_PDLL_RDTESTER_UART_CONNECT_INIT	PLT HW tester UART connection initialized.
GU_PDLL_RDTESTER_UART_CONNECT_START	PLT HW tester UART connection started.
GU_PDLL_RDTESTER_UART_CONNECT_OK	PLT HW tester UART connected successfully.
GU_PDLL_RDTESTER_UART_CONNECT_FAILED	PLT HW tester UART connection failed.
GU_PDLL_RDTESTER_UART_LOOPBACK_INIT	PLT HW tester UART loopback process initialized.
GU_PDLL_RDTESTER_UART_LOOPBACK_START	PLT HW tester UART loopback process started.
GU_PDLL_RDTESTER_UART_LOOPBACK_OK	PLT HW tester UART loopback process success.
GU_PDLL_RDTESTER_UART_LOOPBACK_FAILED	PLT HW tester UART loopback process failed.
GU_PDLL_RDTESTER_VBAT_UART_CNTRL_INIT	PLT HW tester VBAT/UART control initialized.
GU_PDLL_RDTESTER_VBAT_UART_CNTRL_START	PLT HW tester VBAT/UART control started.
GU_PDLL_RDTESTER_VBAT_UART_CNTRL_OK	PLT HW tester VBAT/UART control success.
GU_PDLL_RDTESTER_VBAT_UART_CNTRL_FAILED	PLT HW tester VBAT/UART control failed.
GU_PDLL_RDTESTER_VBAT_UART_RST_CNTRL_INIT	PLT HW tester VBAT/UART/Reset control initialized.
GU_PDLL_RDTESTER_VBAT_UART_RST_CNTRL_START	PLT HW tester VBAT/UART/Reset control started.
GU_PDLL_RDTESTER_VBAT_UART_RST_CNTRL_OK	PLT HW tester VBAT/UART/Reset control success.
GU_PDLL_RDTESTER_VBAT_UART_RST_CNTRL_FAILED	PLT HW tester VBAT/UART/Reset control failed.
GU_PDLL_RDTESTER_VPP_CNTRL_INIT	PLT HW tester VPP control initialized.
GU_PDLL_RDTESTER_VPP_CNTRL_START	PLT HW tester VPP control started.
GU_PDLL_RDTESTER_VPP_CNTRL_OK	PLT HW tester VPP control success.
GU_PDLL_RDTESTER_VPP_CNTRL_FAILED	PLT HW tester VPP control failed.
GU_PDLL_RDTESTER_RST_PULSE_INIT	PLT HW tester Reset pulse control initialized.
GU_PDLL_RDTESTER_RST_PULSE_START	PLT HW tester Reset pulse control started.
GU_PDLL_RDTESTER_RST_PULSE_OK	PLT HW tester Reset pulse control success.
GU_PDLL_RDTESTER_RST_PULSE_FAILED	PLT HW tester Reset pulse control failed.
GU_PDLL_RDTESTER_UART_PULSE_INIT	PLT HW tester XTAL trim pulse in UART TX pin initialized.
GU_PDLL_RDTESTER_UART_PULSE_START	PLT HW tester XTAL trim pulse in UART TX pin started.
GU_PDLL_RDTESTER_UART_PULSE_OK	PLT HW tester XTAL trim pulse in UART TX pin success.
GU_PDLL_RDTESTER_UART_PULSE_FAILED	PLT HW tester XTAL trim pulse in UART TX pin failed.
GU_PDLL_RDTESTER_XTAL_PULSE_INIT	PLT HW tester XTAL trim pulse in GATE pin initialized.
GU_PDLL_RDTESTER_XTAL_PULSE_START	PLT HW tester XTAL trim pulse in GATE pin started.
GU_PDLL_RDTESTER_XTAL_PULSE_OK	PLT HW tester XTAL trim pulse in GATE pin success.
GU_PDLL_RDTESTER_XTAL_PULSE_FAILED	PLT HW tester XTAL trim pulse in GATE pin failed.
GU_PDLL_RDTESTER_PULSE_WIDTH_INIT	PLT HW tester pulse width initialized.

DA1458x/DA1468x Production Line Tool

Status	Description
GU_PDLL_RDTESTER_PULSE_WIDTH_START	PLT HW tester pulse width started.
GU_PDLL_RDTESTER_PULSE_WIDTH_OK	PLT HW tester pulse width success.
GU_PDLL_RDTESTER_PULSE_WIDTH_FAILED	PLT HW tester pulse width failed.
GU_PDLL_RDTESTER_VBAT_CNTRL_INIT	PLT HW tester VBAT control initialized.
GU_PDLL_RDTESTER_VBAT_CNTRL_START	PLT HW tester VBAT control started.
GU_PDLL_RDTESTER_VBAT_CNTRL_OK	PLT HW tester VBAT control success.
GU_PDLL_RDTESTER_VBAT_CNTRL_FAILED	PLT HW tester VBAT control failed.
GU_PDLL_RDTESTER_INVALID_COMMAND	PLT HW tester unknown command.
Golden Unit RF packet transmission for DUT RSSI RF test	
GU_PDLL_PKT_TX_START_INIT	Golden Unit RF packet TX initialized.
GU_PDLL_PKT_TX_START	Golden Unit RF packet TX started.
GU_PDLL_PKT_TX_STARTED_OK	Golden Unit RF packet TX success.
GU_PDLL_PKT_TX_STARTED_FAILED	Golden Unit RF packet TX failed.
GU_PDLL_PKT_TX_ENDED_OK	Golden Unit RF packet TX ended successfully.
GU_PDLL_PKT_TX_STARTED_FAILED	Golden Unit RF packet TX ended failed.
Golden Unit audio tone generation for audio testing	
GU_PDLL_AUDIO_TONE_START_INIT	Golden Unit audio tone start initialized.
GU_PDLL_AUDIO_TONE_START	Golden Unit audio tone start.
GU_PDLL_AUDIO_TONE_STARTED_OK	Golden Unit audio tone started successfully.
GU_PDLL_AUDIO_TONE_START_FAILED	Golden Unit audio tone start failed.
GU_PDLL_AUDIO_TONE_STOP_INIT	Golden Unit audio tone stop initialized.
GU_PDLL_AUDIO_TONE_STOP	Golden Unit audio tone stop.
GU_PDLL_AUDIO_TONE_STOPPED_OK	Golden Unit audio tone stopped successfully.
GU_PDLL_AUDIO_TONE_STOP_FAILED	Golden Unit audio tone stop failed.
Golden Unit GPIO toggling for sanity test	
GU_PDLL_GPIO_TOGGLE_INIT	Golden Unit GPIO toggle operation initialized.
GU_PDLL_GPIO_TOGGLE_START	Golden Unit GPIO toggle operation start.
GU_PDLL_GPIO_TOGGLE_FINISHED_OK	Golden Unit GPIO toggle operation completed successfully.
GU_PDLL_GPIO_TOGGLE_FAILED	Golden Unit GPIO toggle operation failed.
Golden Unit BLE advertising scan test	
GU_PDLL_BLE_SCAN_INIT	Golden Unit scan operation initialized.
GU_PDLL_BLE_SCAN_START	Golden Unit scan operation started.
GU_PDLL_BLE_SCAN_OK	Golden Unit scan operation completed successfully.
GU_PDLL_BLE_SCAN_FAILED	Golden Unit scan operation failed.

Revision History

Revision	Date	Description
1.0	08-Jul-2015	Initial version.
1.1	18-Jan-2016	CLI part is added and Rev D. PLT Hardware
2.0	04-May-2016	Adding text and drawings
3.0	22-May-2016	Adding changes for the DA1468x
4.0	22-Dec-2016	Updated for DA1458x_DA1468x_PLT_v4.0 software release
4.1	06-Oct-2017	Updated for DA1458x_DA1468x_PLT_v4.1 software release
4.2	10-Oct-2017	Updated for DA1458x_DA1468x_PLT_v4.2 software release
4.3	03-Aug-2018	Updated for DA1458x_DA1468x_PLT_v4.3 software release
4.4	03-Feb-2022	Updated logo, disclaimer, copyright.

DA1458x/DA1468x Production Line Tool**Status Definitions**

Status	Definition
DRAFT	The content of this document is under review and subject to formal approval, which may result in modifications or additions.
APPROVED or unmarked	The content of this document has been approved for publication.

RoHS Compliance

Dialog Semiconductor's suppliers certify that its products are in compliance with the requirements of Directive 2011/65/EU of the European Parliament on the restriction of the use of certain hazardous substances in electrical and electronic equipment. RoHS certificates from our suppliers are available on request.