

Introduction

The VersaClock 3S - 5P3502x USB programmer board is designed to ease the way of configuring and programming the blank parts of 5P3502x family of devices. With the on-board USB interface, IDT Timing Commander™ GUI can communicate with the VersaClock 3S devices for configuration and measurement on the board. With additional socket board, configuration can be programmed to blank parts of 5P3502x. The family of VersaClock 3S devices is available on the following part numbers: 5P35023 and 5P35021.

Board Overview

The USB programmer board (Figure 1) is ready with all necessary components and connections. It is available to test the functionality of the configuration and device can be programmed with the additional socket board as shown in Figure 2.

Figure 1. Programmer Board Overview

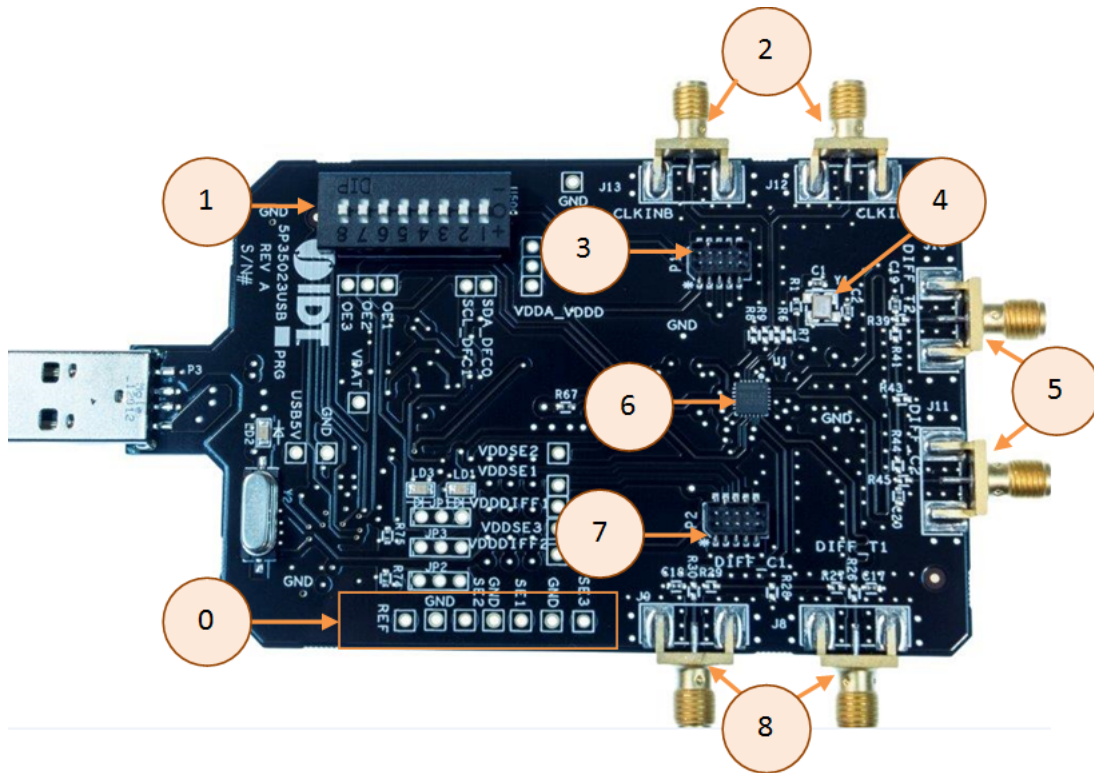

Table 1: Programmer Board Labels and Functions

Serial	Label	Description
0	Single-ended Outputs	These are test points for Single-ended Outputs; SE1, SE2, SE3 and Reference with GND points in between.
1	DIP Switch	This is used to configure the IC in different modes.
2	Clock Inputs	A differential clock can be connected as the source for the device or a single-ended input connected on CLKINB pin.

Serial	Label	Description
3	Socket connector	This is used to mount a 24 or 20 PIN socket board on the top of USB board for programming.
4	25MHz Crystal	Crystal with 8pF load (part number: 603-25-150) is populated.
5	Differential Outputs	This is the differential pair (Out of phase): DIFF-T2 and DIFF-C2.
6	Chip	This device (5P35023) is populated.
7	Socket	This is used to mount a 24 or 20 PIN socket board on the top of USB board for programming.
8	Differential Output	This is another set of differential pair (Out of phase): DIFF-T1 and DIFF-C1.

Table 2: Programming Steps



Step No.	Steps	Comments
1	Plug the board into the USB port	USB provides power to the board and establishes a communication channel between GUI and the device
2	Start Timing Commander Software	Launch the Timing Commander GUI software. Load the personality file. Timing Commander Software Timing Commander Software for VersaClock 3S - 5P35023 User Guide
3	New settings file	Using the Timing Commander GUI, start a new settings file, or open a pre-optimized file.
4	Connect to the board	Upon finalizing the configuration, click on the chip symbol on the top right corner of the GUI window. 
5	–	Once connected new options will be available on a green background indicating that the USB board has successfully connected with the board. 
6	All intended outputs should be available for measurement	Once the outputs have been validated and finalized, disconnect the USB board and install the socket board. Establish GUI connection to the DUT, write all, then proceed to the OTP burn. See “OTP Programming” section.

Figure 2. USB Board (along with the Socket Board)



Connect the USB board along with the socket board as shown above. Please, note that the blank part can only be burnt using the socket board. The part on the programming board is used for the purpose of validation. Once, the validation is complete, the user needs to connect the socket board to burn the part. The socket board supports two types of packages: 20 and 24 pins. The following description and images are restricted to 24 PIN socket board.

Upon completing the steps as described previously, proceed to install the socket board on the USB board.

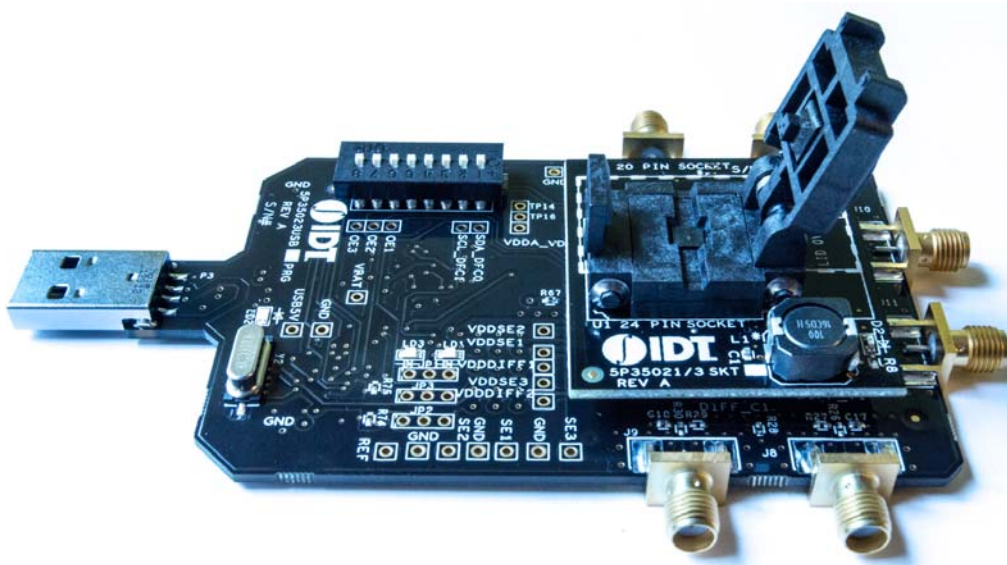
When socket is open, identify the position of Pin 1 as shown in Figure 3. Align the dot of the blank device with the round dent engraved on the corner of the socket as pointed. After placing the blank device, secure the socket cover.

Figure 3. Socket Board (Pin Position)

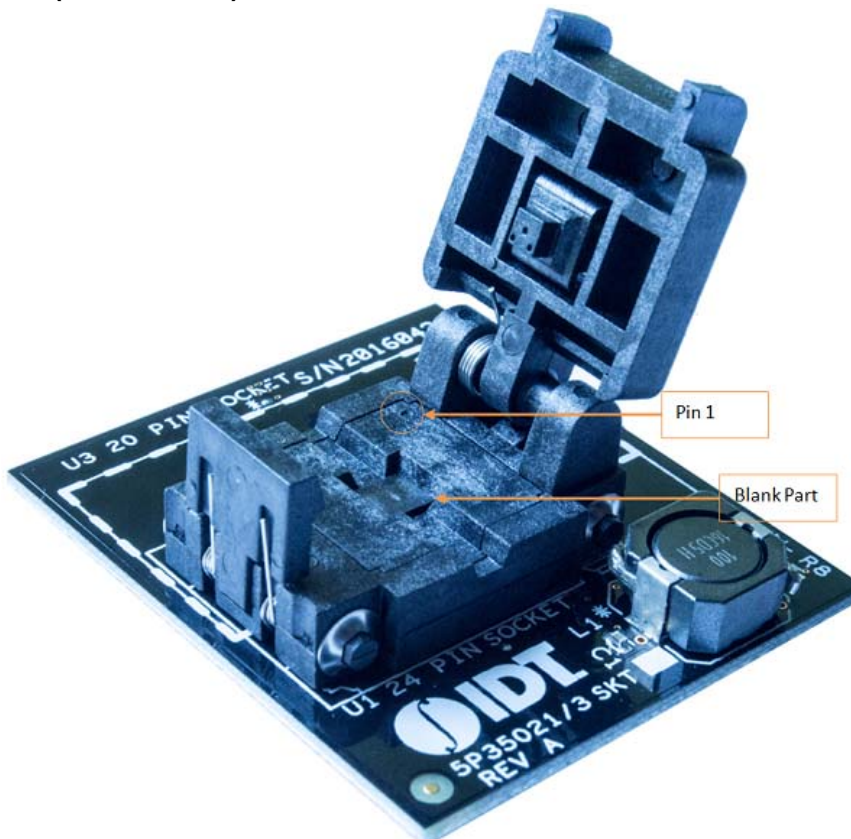

OTP Programming

Using the following steps the user can proceed with the OTP burn.

Figure 4. OTP Dialogue Window



Step 1. Upon clicking on the OTP as shown a new pop-up window will open up as shown in [Figure 5](#). Click on the “Click for OTP - Programming board” to burn the part.

Figure 5. OTP – Programming Board

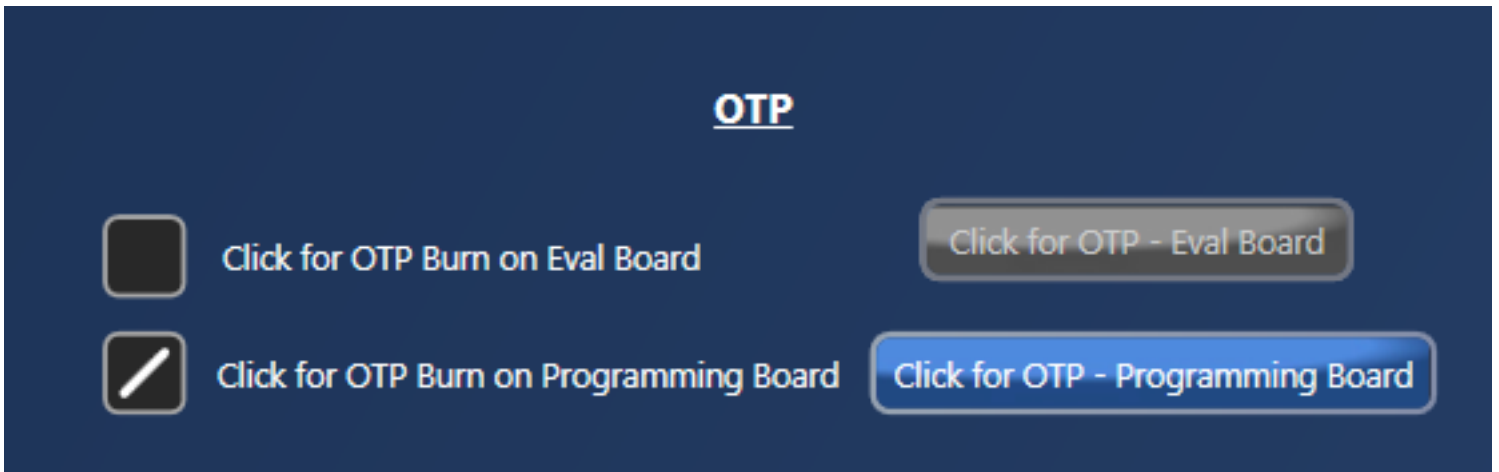

Step 2. Upon completing step 1, a dialogue box will appear as shown in [Figure 6](#). Click “Yes” to proceed.

Figure 6. OTP – 6.5V Switch

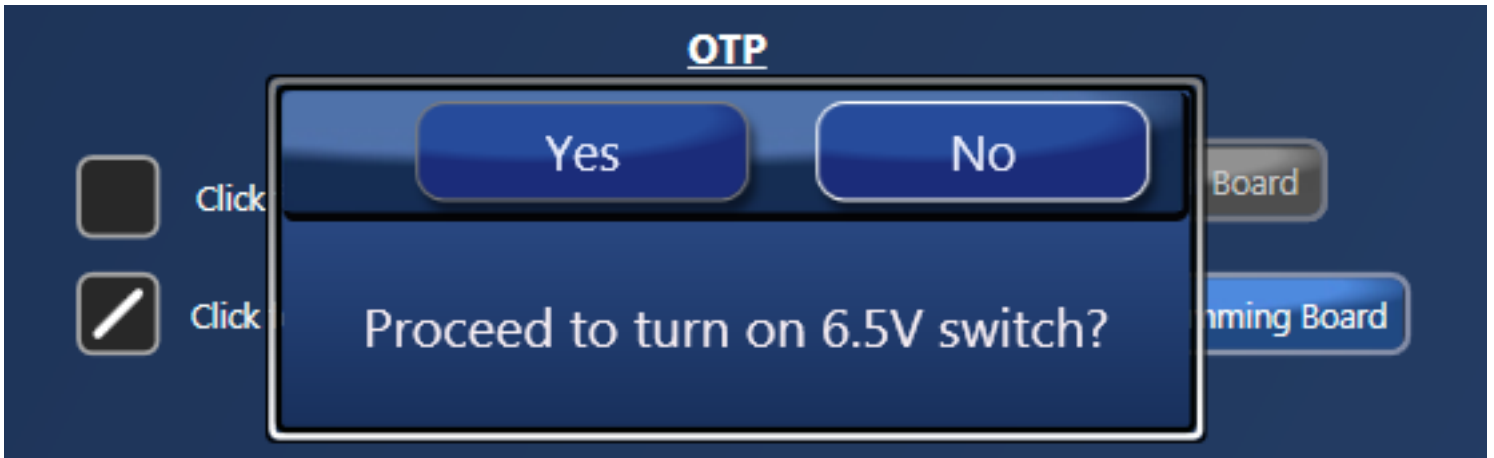
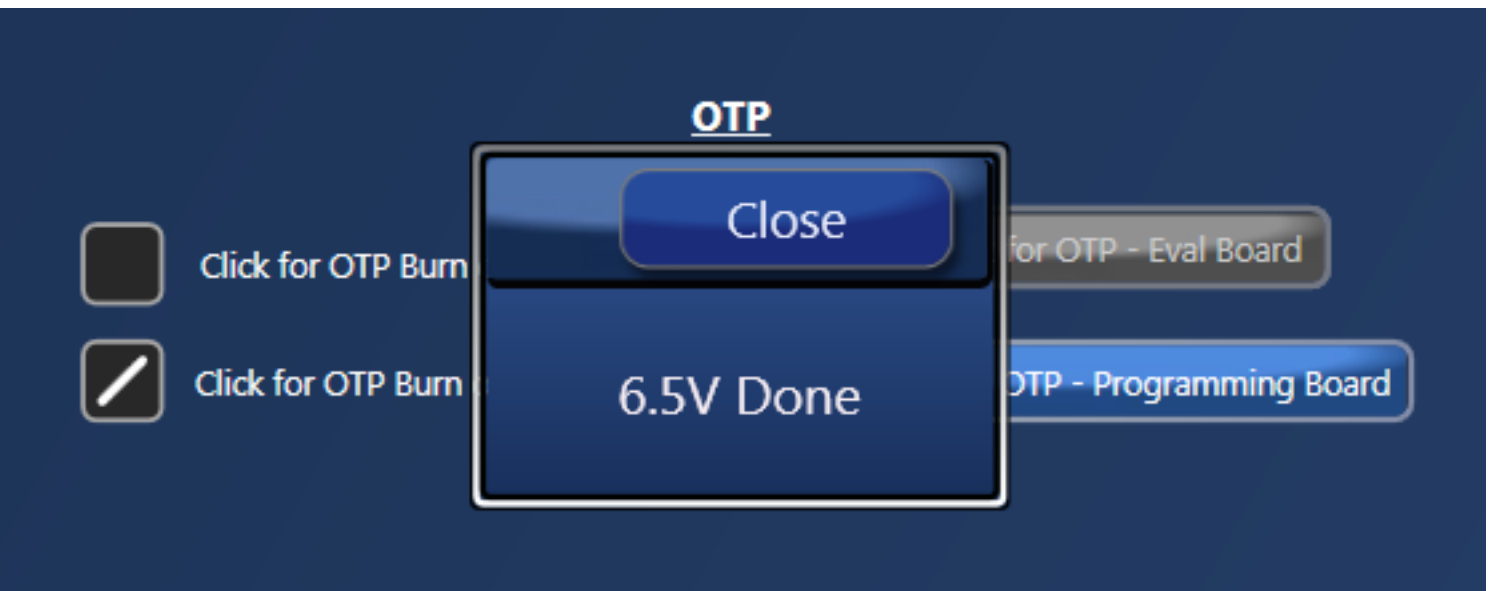
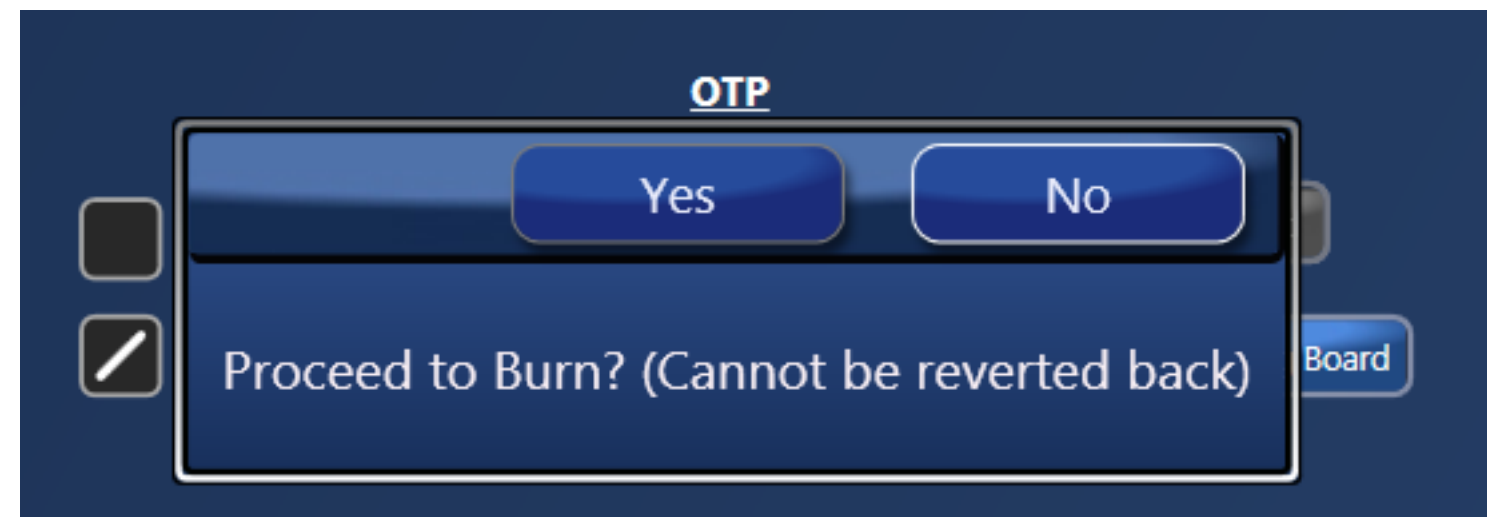

Figure 7. OTP – 6.5V Done



Step 3. Once the previous step is completed, a new window will pop-up confirming to proceed with the OTP burn. Please note that this process cannot be reverted back.

Figure 8. OTP – Proceed to Burn



Step 4. If the OTP burn process is completed, a message “OTP Programmed Successfully” will appear indicating that the process is completed, and the part has been burnt.

Figure 9. OTP Programmed Successfully

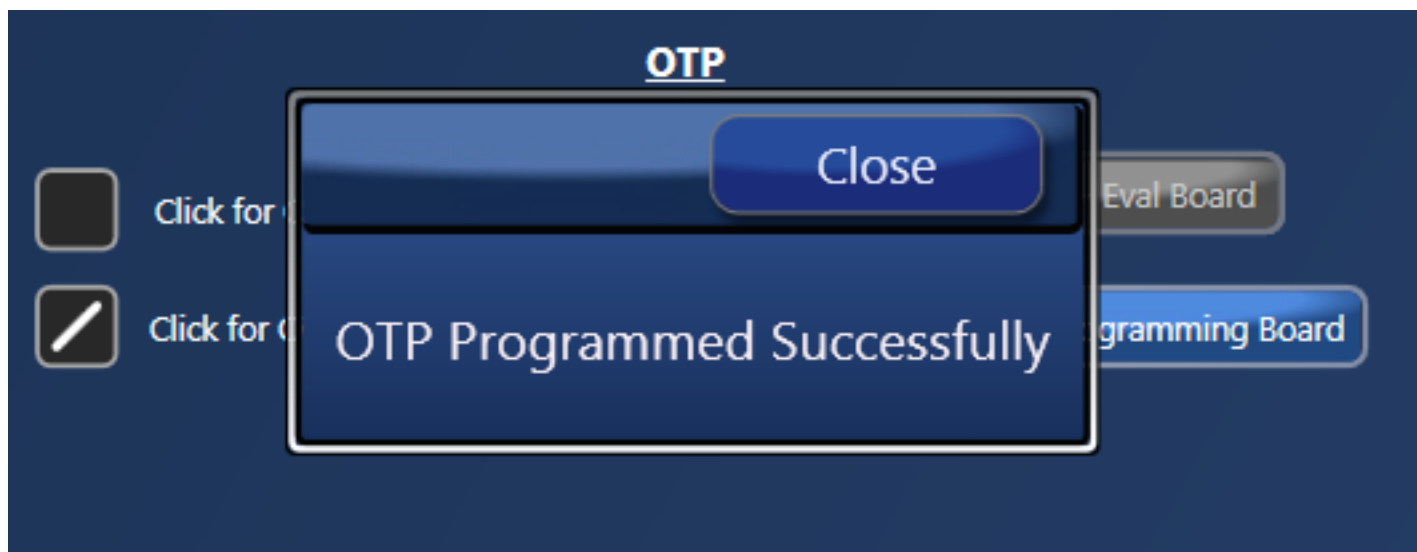
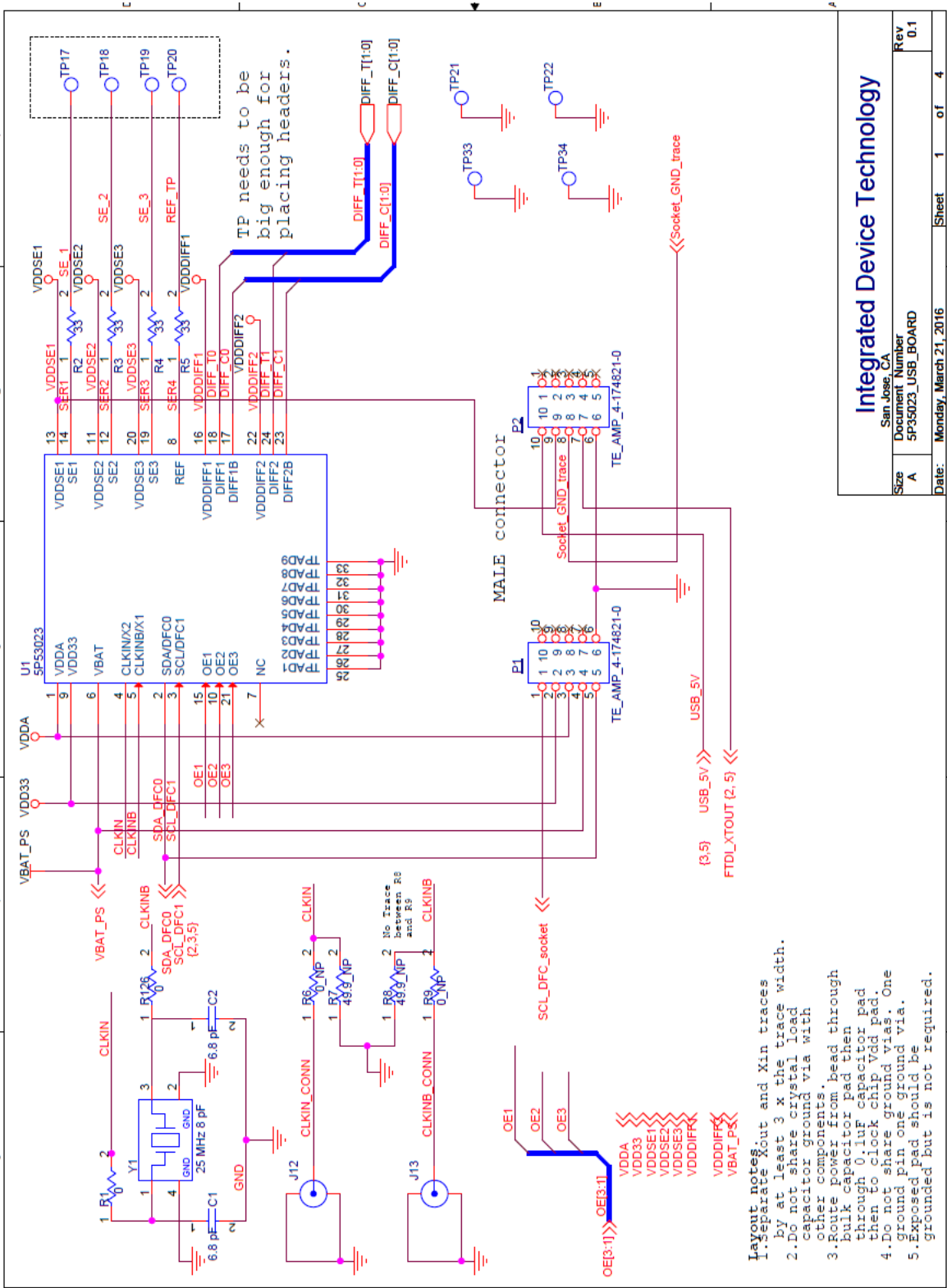

Figure 10. Schematic 1



Integrated Device Technology	
San Jose, CA	
Size	Document Number
A	SP53023_USB_BOARD
Date:	Monday, March 21, 2016
Sheet	1 of 4
Rev	0.1

Figure 11. Schematic 2

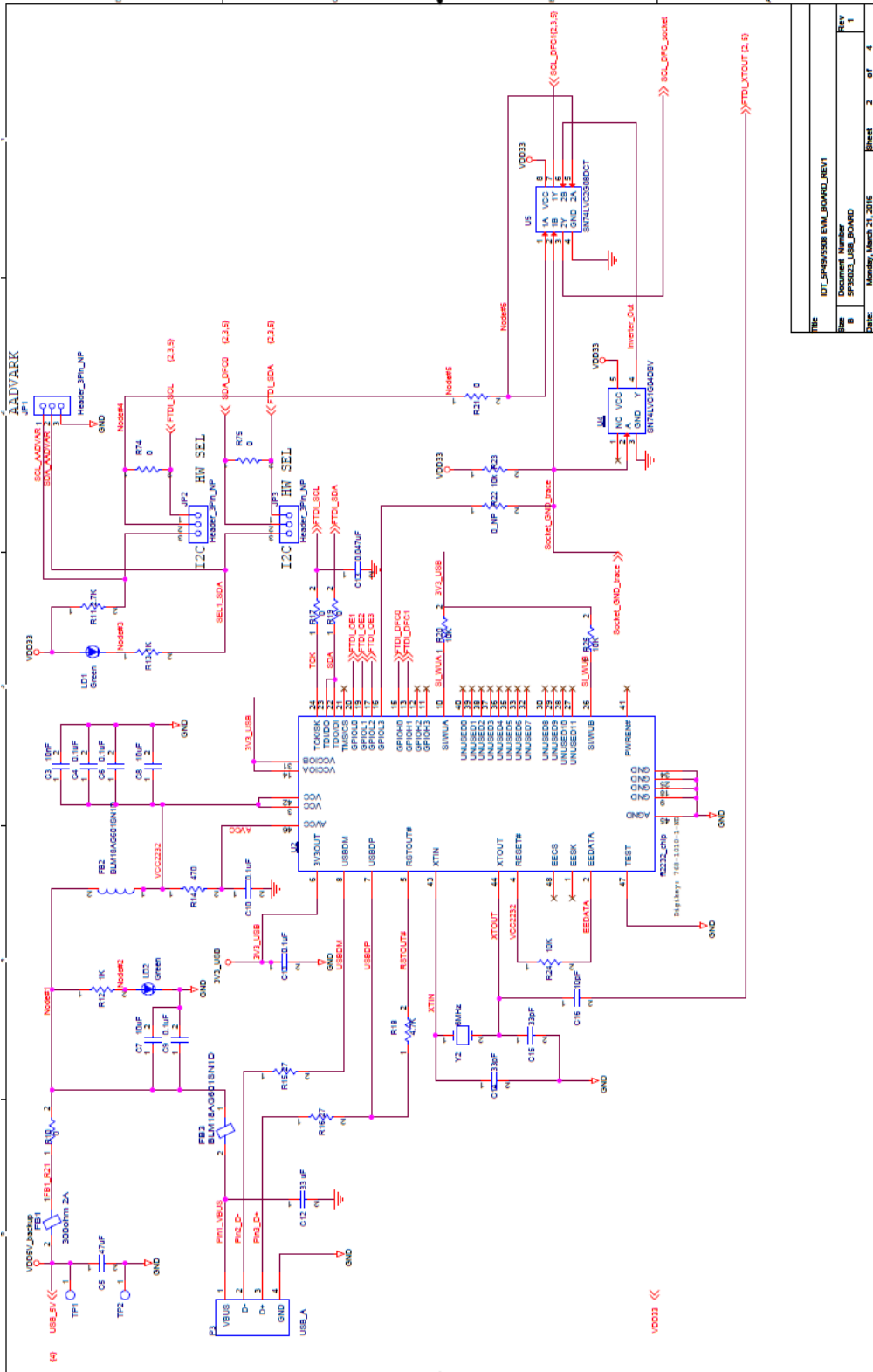

Figure 12. Schematic 3

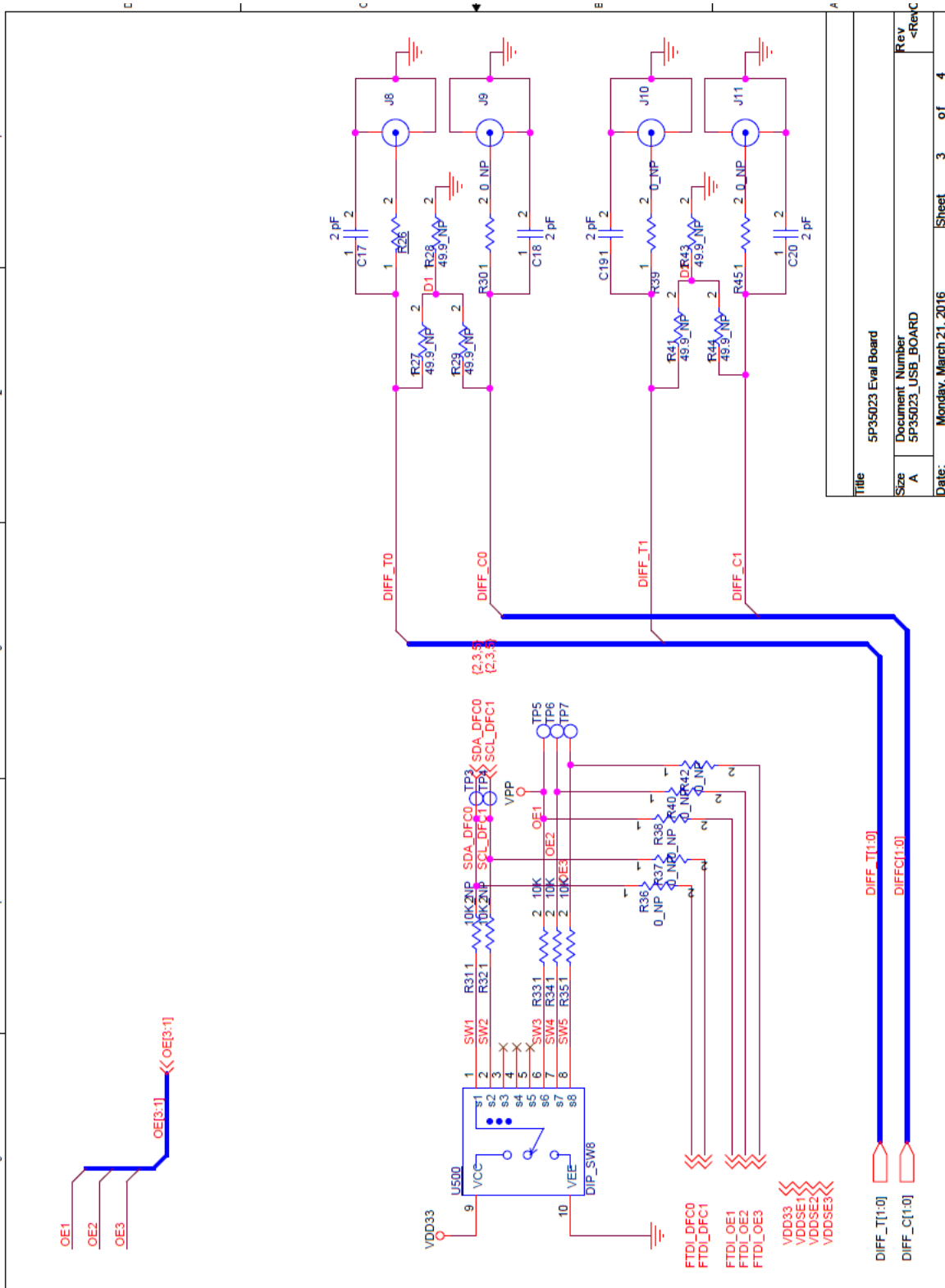
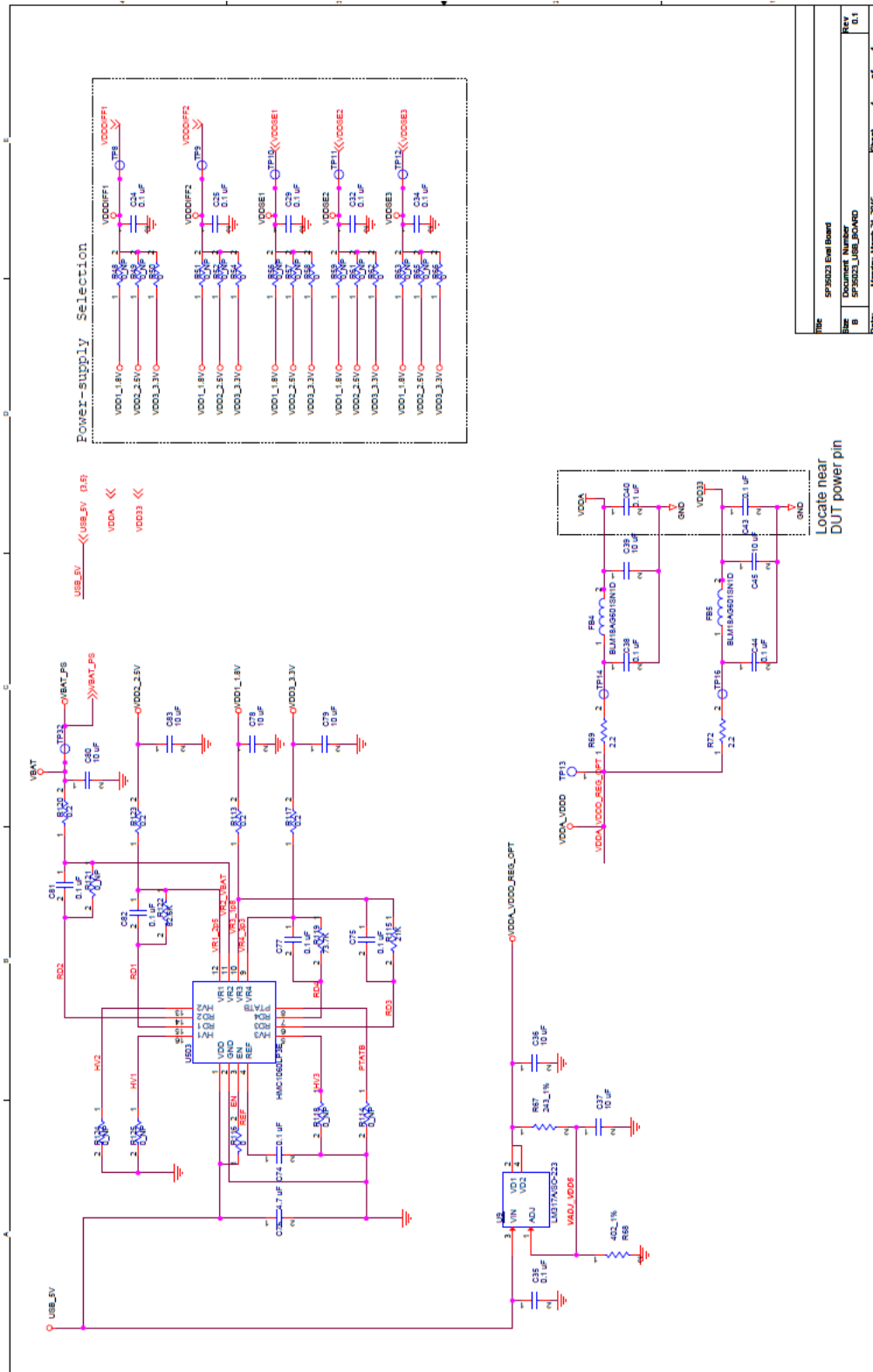

Figure 13. Schematic 4



File	SPR023 Eval Board
Size	Document Number
Rev	B
Doc	SPR023_USB_POWER
Sheet	Monday, March 21, 2018
Sheet	4 of 4
Rev	0.1

Locate near DUT power pin

Table 3: Termination Options for Differential Output (DIFF_T0/C0)

Signal Type	Series Capacitors: C17, C18	Resistor Network: R27, R28, R29	Resistor Network: R26, R30
**LPHCSL	2pF	Not installed	0 ohm

Table 4: Termination Options for Differential Output (DIFF_T1/C1)

Signal Type	Series Capacitors: C19, C20	Resistor Network: R41, R43, R44	Resistor Network: R39, R45
**LPHCSL	2pF	Not installed	0 ohm

Table 5: Termination Options for Single-ended 1

Signal Type	Series Resistors: R2
*LVCMOS	33Ω

Table 6: Termination Options for Single-ended 2

Signal Type	Series Resistors: R3
*LVCMOS	33Ω

Table 7: Termination Options for Single-ended 3

Signal Type	Series Resistors: R4
*LVCMOS	33Ω

As noted, 4-resistor network is not installed in [Table 3](#) and [Table 4](#) because oscilloscope with internal 50Ω termination is utilized for signal termination and measurement. If an AC-coupled, stand-alone LVPECL output is needed (without oscilloscope connections), the 4-resistor network needs to be installed accordingly.

* The Signal Type for Single-ended outputs by default is LVCMOS, and cannot be changed.

** The Signal Type for Differential outputs by default is LPHCSL. Contact IDT, if the user needs to change the Signal type.

Figure 14. USB Board (along with 20 PIN Socket Board)



Notice

1. Descriptions of circuits, software and other related information in this document are provided only to illustrate the operation of semiconductor products and application examples. You are fully responsible for the incorporation or any other use of the circuits, software, and information in the design of your product or system. Renesas Electronics disclaims any and all liability for any losses and damages incurred by you or third parties arising from the use of these circuits, software, or information.
2. Renesas Electronics hereby expressly disclaims any warranties against and liability for infringement or any other claims involving patents, copyrights, or other intellectual property rights of third parties, by or arising from the use of Renesas Electronics products or technical information described in this document, including but not limited to, the product data, drawings, charts, programs, algorithms, and application examples.
3. No license, express, implied or otherwise, is granted hereby under any patents, copyrights or other intellectual property rights of Renesas Electronics or others.
4. You shall be responsible for determining what licenses are required from any third parties, and obtaining such licenses for the lawful import, export, manufacture, sales, utilization, distribution or other disposal of any products incorporating Renesas Electronics products, if required.
5. You shall not alter, modify, copy, or reverse engineer any Renesas Electronics product, whether in whole or in part. Renesas Electronics disclaims any and all liability for any losses or damages incurred by you or third parties arising from such alteration, modification, copying or reverse engineering.
6. Renesas Electronics products are classified according to the following two quality grades: "Standard" and "High Quality". The intended applications for each Renesas Electronics product depends on the product's quality grade, as indicated below.
 - "Standard": Computers; office equipment; communications equipment; test and measurement equipment; audio and visual equipment; home electronic appliances; machine tools; personal electronic equipment; industrial robots; etc.
 - "High Quality": Transportation equipment (automobiles, trains, ships, etc.); traffic control (traffic lights); large-scale communication equipment; key financial terminal systems; safety control equipment; etc.
- Unless expressly designated as a high reliability product or a product for harsh environments in a Renesas Electronics data sheet or other Renesas Electronics document, Renesas Electronics products are not intended or authorized for use in products or systems that may pose a direct threat to human life or bodily injury (artificial life support devices or systems; surgical implantations; etc.), or may cause serious property damage (space system; undersea repeaters; nuclear power control systems; aircraft control systems; key plant systems; military equipment; etc.). Renesas Electronics disclaims any and all liability for any damages or losses incurred by you or any third parties arising from the use of any Renesas Electronics product that is inconsistent with any Renesas Electronics data sheet, user's manual or other Renesas Electronics document.
7. No semiconductor product is absolutely secure. Notwithstanding any security measures or features that may be implemented in Renesas Electronics hardware or software products, Renesas Electronics shall have absolutely no liability arising out of any vulnerability or security breach, including but not limited to any unauthorized access to or use of a Renesas Electronics product or a system that uses a Renesas Electronics product. RENESAS ELECTRONICS DOES NOT WARRANT OR GUARANTEE THAT RENESAS ELECTRONICS PRODUCTS, OR ANY SYSTEMS CREATED USING RENESAS ELECTRONICS PRODUCTS WILL BE INVULNERABLE OR FREE FROM CORRUPTION, ATTACK, VIRUSES, INTERFERENCE, HACKING, DATA LOSS OR THEFT, OR OTHER SECURITY INTRUSION ("Vulnerability Issues"). RENESAS ELECTRONICS DISCLAIMS ANY AND ALL RESPONSIBILITY OR LIABILITY ARISING FROM OR RELATED TO ANY VULNERABILITY ISSUES. FURTHERMORE, TO THE EXTENT PERMITTED BY APPLICABLE LAW, RENESAS ELECTRONICS DISCLAIMS ANY AND ALL WARRANTIES, EXPRESS OR IMPLIED, WITH RESPECT TO THIS DOCUMENT AND ANY RELATED OR ACCOMPANYING SOFTWARE OR HARDWARE, INCLUDING BUT NOT LIMITED TO THE IMPLIED WARRANTIES OF MERCHANTABILITY, OR FITNESS FOR A PARTICULAR PURPOSE.
8. When using Renesas Electronics products, refer to the latest product information (data sheets, user's manuals, application notes, "General Notes for Handling and Using Semiconductor Devices" in the reliability handbook, etc.), and ensure that usage conditions are within the ranges specified by Renesas Electronics with respect to maximum ratings, operating power supply voltage range, heat dissipation characteristics, installation, etc. Renesas Electronics disclaims any and all liability for any malfunctions, failure or accident arising out of the use of Renesas Electronics products outside of such specified ranges.
9. Although Renesas Electronics endeavors to improve the quality and reliability of Renesas Electronics products, semiconductor products have specific characteristics, such as the occurrence of failure at a certain rate and malfunctions under certain use conditions. Unless designated as a high reliability product or a product for harsh environments in a Renesas Electronics data sheet or other Renesas Electronics document, Renesas Electronics products are not subject to radiation resistance design. You are responsible for implementing safety measures to guard against the possibility of bodily injury, injury or damage caused by fire, and/or danger to the public in the event of a failure or malfunction of Renesas Electronics products, such as safety design for hardware and software, including but not limited to redundancy, fire control and malfunction prevention, appropriate treatment for aging degradation or any other appropriate measures. Because the evaluation of microcomputer software alone is very difficult and impractical, you are responsible for evaluating the safety of the final products or systems manufactured by you.
10. Please contact a Renesas Electronics sales office for details as to environmental matters such as the environmental compatibility of each Renesas Electronics product. You are responsible for carefully and sufficiently investigating applicable laws and regulations that regulate the inclusion or use of controlled substances, including without limitation, the EU RoHS Directive, and using Renesas Electronics products in compliance with all these applicable laws and regulations. Renesas Electronics disclaims any and all liability for damages or losses occurring as a result of your noncompliance with applicable laws and regulations.
11. Renesas Electronics products and technologies shall not be used for or incorporated into any products or systems whose manufacture, use, or sale is prohibited under any applicable domestic or foreign laws or regulations. You shall comply with any applicable export control laws and regulations promulgated and administered by the governments of any countries asserting jurisdiction over the parties or transactions.
12. It is the responsibility of the buyer or distributor of Renesas Electronics products, or any other party who distributes, disposes of, or otherwise sells or transfers the product to a third party, to notify such third party in advance of the contents and conditions set forth in this document.
13. This document shall not be reprinted, reproduced or duplicated in any form, in whole or in part, without prior written consent of Renesas Electronics.
14. Please contact a Renesas Electronics sales office if you have any questions regarding the information contained in this document or Renesas Electronics products.

(Note1) "Renesas Electronics" as used in this document means Renesas Electronics Corporation and also includes its directly or indirectly controlled subsidiaries.

(Note2) "Renesas Electronics product(s)" means any product developed or manufactured by or for Renesas Electronics.

(Disclaimer Rev.5.0-1 October 2020)

Corporate Headquarters

TOYOSU FORESIA, 3-2-24 Toyosu,
Koto-ku, Tokyo 135-0061, Japan
www.renesas.com

Trademarks

Renesas and the Renesas logo are trademarks of Renesas Electronics Corporation. All trademarks and registered trademarks are the property of their respective owners.

Contact Information

For further information on a product, technology, the most up-to-date version of a document, or your nearest sales office, please visit:
www.renesas.com/contact/