

Restrictions:

IDT's ZACwire™ SSC Modular Evaluation Kit (SSC Evaluation Kit) hardware and software are designed for evaluation of the ZSC31010, ZSC31015, or ZSSC3015; laboratory setup; and module development only. The ZACwire™ SSC Modular Evaluation Kit hardware and software must not be used for module production and production test setups.

IDT shall not be liable for any damages arising out of defects resulting from (i) delivered hard and software (ii) non-observance of instructions contained in this manual, or (iii) misuse, abuse, use under abnormal conditions or alteration by anyone other than IDT. To the extent permitted by law, IDT hereby expressly disclaims and User expressly waives any and all warranties, whether express, implied, or statutory, including, without limitation, implied warranties of merchantability and of fitness for a particular purpose, statutory warranty of non-infringement and any other warranty that may arise by reason of usage of trade, custom or course of dealing.

Contents

1	Kit Contents	4
2	SSC Evaluation Board.....	5
2.1.	Overview.....	5
2.2.	Connections to the DUT	6
2.3.	Power Supply to the Board.....	6
2.4.	Reset Switch.....	6
3	Software Installation and Setup.....	6
3.1.	Installing the ZACwire™ SSC Evaluation Kit Software	6
3.2.	Installing the USB Drivers.....	7
3.3.	HW Type / Select Product / Find COM / Initialize HW Button	7
4	SSC Evaluation Kit Software.....	9
4.1.	Software Overview	9
4.1.1.	Bridge and Temperature Display	9
4.1.2.	Data Logging Section.....	10
4.1.3.	EEPROM Section.....	10
4.1.4.	Command Interface Section.....	11
4.1.5.	Response Field	11
4.1.6.	Command/Subcommand/Data Fields	12
4.1.7.	Send Button.....	12
4.1.8.	Start CM Button.....	12
4.1.9.	Start NOM Button.....	12
4.1.10.	Start RM Button.....	12

4.1.11. Normal Mode Section.....	12
4.1.12. Output Mode Section.....	13
4.1.13. Adjustment of the Analog Pre-Amp Gain and the Analog ADC Offset Modes.....	13
4.1.14. Calibration Button.....	14
4.2. Calibration Sequence.....	15
4.2.1. Step 1 – Assigning a Unique Identification (ASIC ID Section).....	16
4.2.2. Step 2 – Data Collection.....	17
4.2.3. Step 3 – Calculate & Write Coefficients.....	18
4.3. Section Output Range Checking.....	18
5 Dry Run Calibration.....	19
6 Calculation of Calibration Coefficients Off-line.....	21
7 SSC Evaluation Kit Software with the IDT SSC Terminal.....	24
7.1. Protocol.....	24
7.2. IDT SSC Terminal.....	24
8 Related Documents.....	26
9 Definitions of Acronyms.....	27
10 Document Revision History.....	27
Appendix A: Schematic ZSC31010 SSC Evaluation Board.....	29

List of Figures

Figure 1.1	ZACwire™ SSC Modular Evaluation Kit.....	4
Figure 2.1	SSC Evaluation Board Overview.....	5
Figure 3.1	Hardware Type Selection Example for ZSC31010.....	8
Figure 3.2	Product and COM Port Selection Example for ZSC31010.....	8
Figure 4.1	Bridge and Temperature Display and Data Logging Screen (ZSC31010 Coefficients Shown).....	10
Figure 4.2	EEPROM Section Example (ZSC31010 Coefficients Shown).....	11
Figure 4.3	Calibration Window Example (ZSC31010 Coefficients Shown).....	15
Figure 4.4	ASIC ID Section for Initialization, Identification, and Adjustment (ZSC31010 Settings Shown).....	16
Figure 4.5	Section Output Range Checking.....	18
Figure 5.1	Example for a 2-Point Calibration (ZSC31010 Coefficients Shown).....	20
Figure 6.1	Fields for Manually Entering Target and Raw Values (ZSC31010 Coefficients Shown).....	23
Figure 7.1	SSC Terminal Example.....	25

List of Tables

Table 4.1	Output Mode Options.....	13
Table 4.2	Programmable Pre-amp Gain Settings.....	14
Table 6.1	Example Spreadsheet Data.....	22
Table 7.1	SSC Terminal Command Format.....	24

1 Kit Contents

- SSC Communication Board Ver. X.x (CB) and cable (for further information on the CB, see *SSC_Communication Board_VX-x_DataSheet_Rev_X_x.pdf*, which is available at www.IDT.com; see section 8 for details)
- ZSC31010 SSC Evaluation Board V1.0, which is used for the ZSC31010, ZSC31015, and ZSSC3015.
- SSC Sensor Replacement Board (SRB) (SSC Sensor Dummy V2.0)
- Five samples of the ZSC31010, ZSC31015, or ZSSC3015 (SOP8 150mil)
- SSC Test Board V1.0

Note: The ZACwire™ SSC Evaluation Kit Software is downloaded from IDT’s website at www.IDT.com as described in section 3.1.

Figure 1.1 ZACwire™ SSC Modular Evaluation Kit

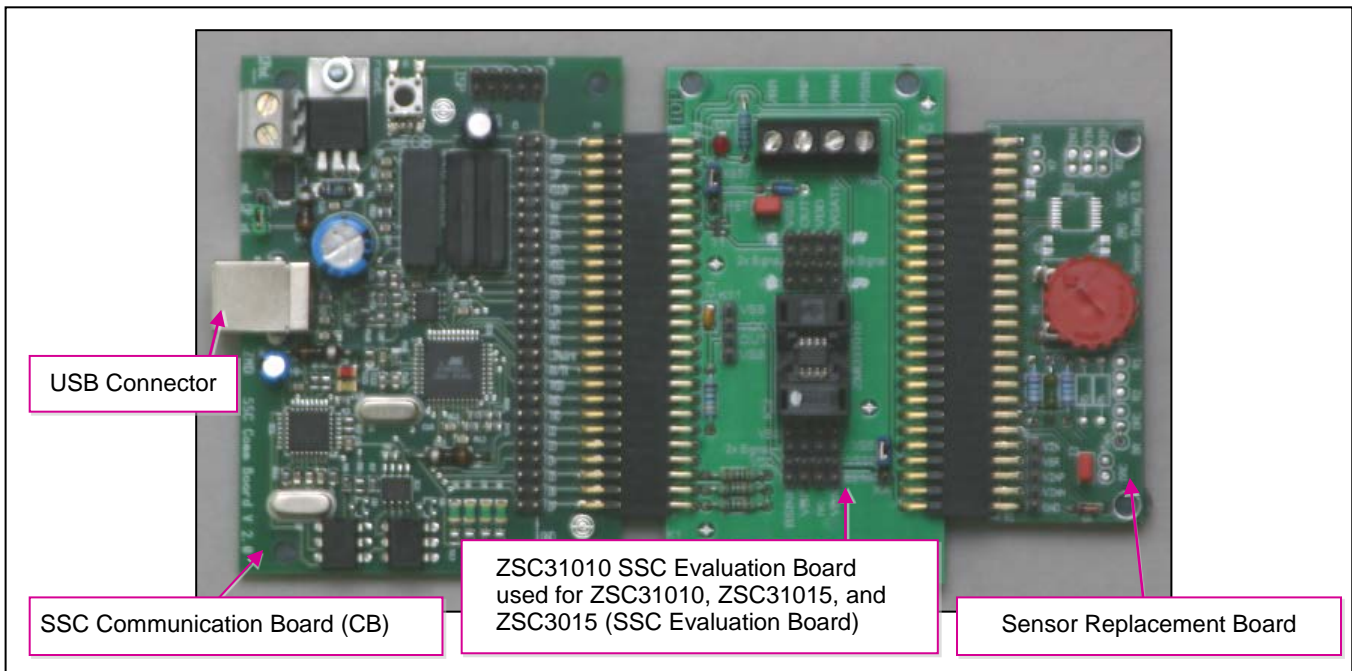

The ZACwire™ SSC Modular Evaluation Kit (SSC Evaluation Kit) provides the hardware needed for communication and calibration of the ZSC31010, ZSC31015, or ZSSC3015 sensor signal conditioning (SSC) ICs. A PC can communicate with the ZSC31010 SSC Evaluation Board (used for all three products) via the SSC Communication Board (CB) through a USB connection. The software should function on any Windows® 2000/XP/ Vista /Windows® 7/Windows® 8 system after the installation of a USB driver.

2 SSC Evaluation Board

2.1. Overview

The main purpose of the SSC Evaluation Kit is to perform communication between the user's PC and the ZSC31010, ZSC31015, or ZSSC3015 (referred to as the DUT). The PC sends commands and data via the USB port on the CB (virtual COM port). The microcontroller on the CB interprets these commands and relays them to the DUT in the ZACwire™ format (connector K1, Pin 39; see Figure 2.1). The microcontroller will also forward any data bytes from the DUT back to the PC via the USB connection. These bytes can be bridge and temperature readings to be displayed by the ZACwire™ SSC Evaluation Kit software or raw ADC readings used during calibration or EEPROM content bytes.

Figure 2.1 SSC Evaluation Board Overview

Jumper K3
 Without JFET (KS5V)
 With JFET (KS12V)

K1 Connector to the SSC CB

Pin 1 on DUT

Resistors for Board Identification

KL1 Connector to External Bridge

VDD	VDD	VDD	VDD
VSS	OUT	VDD	Vgate
VSS	OUT	VDD	Vgate
VSS	VSS	VSS	VSS

K2 Connector to SRB

VSS	VSS	VSS	VSS
Bsink	VBP	Ext. Temp.	VBN
Bsink	VBP	Ext. Temp.	VBN
VDD	VDD	VDD	VDD

K4 Jumper
 Bridge GND to B_{Sink}
 Bridge GND to VSS

*Ext. Temp pin only available on ZSC31015 and ZSC3015. This pin is not connected (nc) for the ZSC31010.

2.2. Connections to the DUT

The SSC Evaluation Board has an SOP-8 socket location for inserting the DUT.

Using the KS5V signal for the power supply, the ZACwire™ signal (OWI), and the ground (GND) connection on connector K4 on the CB, the board can be used for in-circuit programming of the DUT in the user's calibration fixture. **Important:** In this case (without the SSC Evaluation Board) a 3.3kΩ pull-up resistor must be added to the CB between OWI and Tr D2 or between OWI and KS5V (if connected).

NOTE: Only one ASIC connection option can be used at a time.

2.3. Power Supply to the Board

The K1 connector to the CB provides the power supply from the CB's USB port to the SSC Evaluation Board. All functions of the board are operative down to 2.7V. The board has a red LED labeled D1 which lights if the board has power.

2.4. Reset Switch

During operation, use the push button on the CB to reset communications. Note: If the communication port is open, the hardware must be re-initialized using the "Initialize HW" button in the software (see Figure 4.1) following a reset.

3 Software Installation and Setup

3.1. Installing the ZACwire™ SSC Evaluation Kit Software

The ZACwire™ SSC Modular Evaluation Kit does not include the software, which must be downloaded from the IDT website (www.IDT.com) to ensure receiving the latest release. To download the software, navigate to the product page as follows:

- ZSC31010: www.IDT.com/ZSC31010
- ZSC31015: www.IDT.com/ZSC31015
- ZSSC3015: www.IDT.com/ZSSC3015

On the product page, under the heading "General Documents and Supporting Materials," click on the link titled "ZACwire™ Evaluation Software Rev.X" (where X is the current revision) and follow the dialog instructions as needed to download the zip file for the software.

Open the zip file and extract the ZACwireSSC_Setup_vX.exe file.

To install the ZACwire™ SSC Evaluation Kit software on the user's PC hard drive, double-click on the downloaded *ZACwireSSC_Setup_vX.exe* file. Respond to the dialog box to select the installation directory, and the software will complete the installation, which results in a program shortcut on the desktop of the PC.

Note: When the software is activated for the first time, the kit type ("HW type") and product type (ZSC31010, ZSC31015, or ZSSC3015) must be selected and the COM port must be entered as described in section 3.3.

3.2. Installing the USB Drivers

The SSC Evaluation Kit requires installation of two USB drivers. To install the drivers, the user's system must meet these requirements:

- x86-compatible PC
- 32 MB RAM
- Hard drive with 20MB free space
- USB port
- Windows® 2000/XP/ Vista / Windows® 7 / Windows® 8

The two required driver files can be downloaded from www.IDT.com/SSC-COMM-BD. Click on the link titled "SSC CB USB Driver Rev. X" (where X is the current revision) and follow the dialog instructions as needed to download the zip file for the drivers and extract the files. These drivers will make the PC's USB port appear as a virtual COM port (typically COM3 or COM4 on most computers). The SSC Evaluation Kit software accesses the SSC Evaluation Board through the CB as if it were a COM (RS232) port. These drivers will not affect the operation of any other USB peripherals.

Refer to *SSC_AN_CommunicationBoard_Driver_Installation_Rev_X_x.pdf* for instructions on installing these two drivers and for determining the virtual COM port for the SSC Evaluation Kit, which is needed for setting up the kit. This document is available under the "General Documents and Supporting Materials" heading.

3.3. HW Type / Select Product / Find COM / Initialize HW Button

After installing the software and the USB drivers, activate the software. On the "Setup" pull-down menu, select "HW Type" and then "SSC Eval Kit" as shown in Figure 3.1.

Then click on "Select Product" under the "Setup" menu and select ZSC31010, ZSC31015, or ZSSC3015 as shown in Figure 3.2. The title bar of the screen will change to reflect the product selection.

Next, enter the correct virtual COM port setting to use for the PC ↔ SSC Evaluation Board communication via USB as shown in Figure 3.2. If the correct setting is unknown, click the "Find COM" button under the "Setup" menu and accept the port found or continue searching until the COM port setting is correct. Click on "Initialize HW" to set up the SSC hardware for operation.

If the Initialization was successful, the status window on the right side of the screen will say "Initializing HW... OK." If communication fails, an error message detailing the reason for failure will be displayed. For a full list of all communication-related error messages, see the "Error-Code" tab in the spreadsheet *SSC_CommunicationBoard_CommandSyntax_Rev_X_x.xls* (see section 7.2).

Figure 3.1 Hardware Type Selection Example for ZSC31010

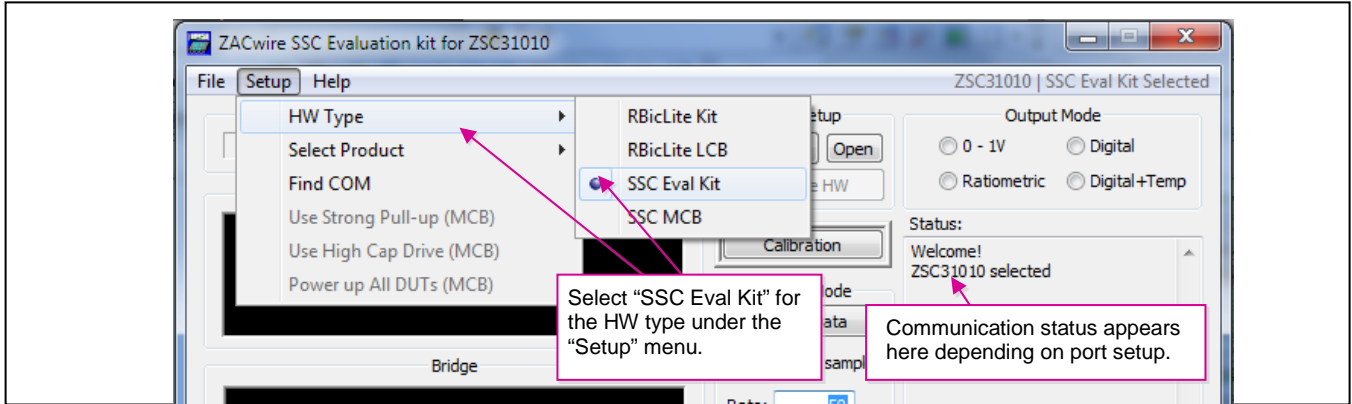
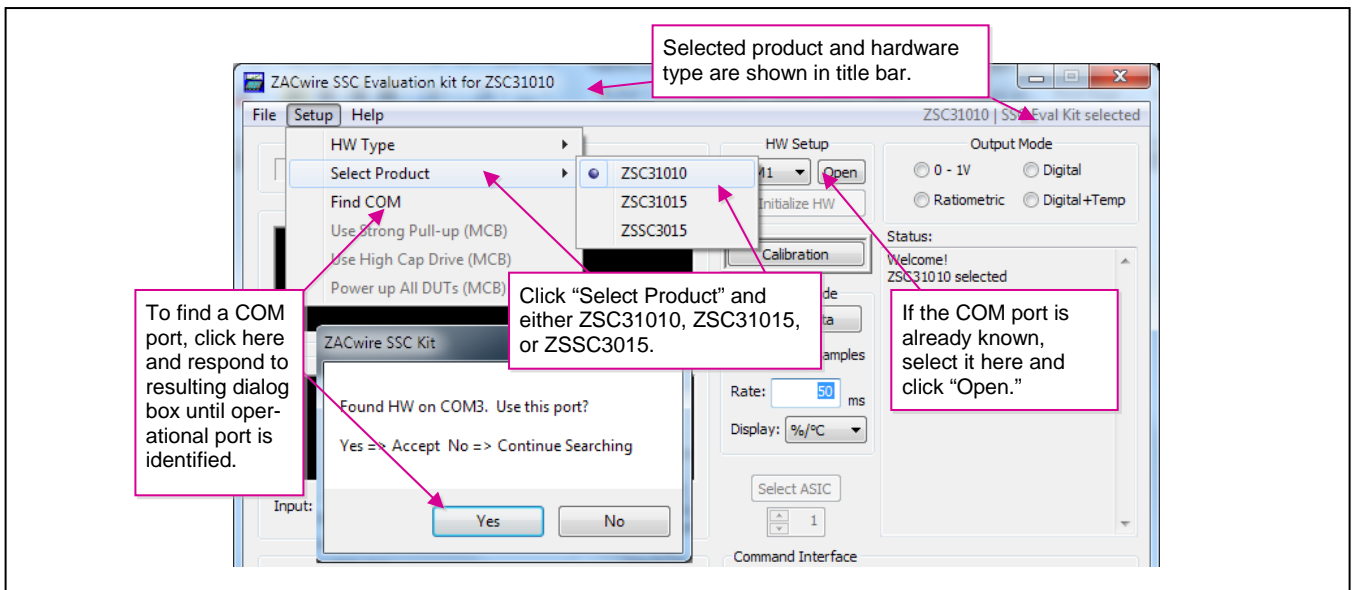

Figure 3.2 Product and COM Port Selection Example for ZSC31010



4 SSC Evaluation Kit Software

4.1. Software Overview

The SSC Evaluation Kit software provided with the SSC Evaluation Kit is intended for demonstration purposes and calibration of single units. IDT can provide the user with algorithms and assistance in developing their full production calibration software. The default installation folder is *C:\Program Files\ZMDI\ZACwire SSC Kit*. Four types of text files support the software user. These files are saved in the *My Documents* folder under *ZMDI\ZSC31010*, *ZMDI\ZSC31015*, or *ZMDI\ZSSC3015* depending on the “Select Product” setting described in section 3.3.

- When the software is activated, a *CommLog.txt* file is saved. This file is a log of the communication to the IC during the software session and can be saved after closing the software by renaming the file. Otherwise, it would be overwritten the next time the software is opened.
- In Command Mode (CM), the user can save/load the EEPROM contents from a user-selected *.eep file to the EEPROM.
- In Normal Operation Mode (NOM), the user can log bridge and temperature readings to a user-selected file.
- The calibration is documented in the *CalibrationLog_DDMMMYYYY.txt* file.

4.1.1. Bridge and Temperature Display

The software displays two large readout windows for temperature and bridge values as shown in Figure 4.1. The temperature reading is the DUT temperature in °C. The bridge reading is in %. Calibration determines the relationship of the % reading to the value the bridge is measuring. The IC is designed to be a generic resistive bridge sensor signal conditioner, but for the following calibration example, assume it is connected to a pressure bridge. If the unit is calibrated to read pressure with 50kPa reading as 100% and 10kPa reading as 0%, then the span of pressure readings would be 40kPa. Half that span (20kPa) plus the set zero point (10kPa) should be the 50% point. After calibration, if the chamber is set to 30kPa, the RBic™ should give a 50% reading.

These readout windows only display temperature and bridge readings if the IC is programmed in digital output configuration. There are two digital output configurations:

- Transmission of bridge readings and temperature
- Transmission of only bridge readings (no temperature)

Temperature is not displayed unless the IC is configured to transmit both bridge and temperature in Digital Mode.

If the DUT is programmed for analog output mode, the microcontroller’s built-in 10-bit analog-to-digital converter (ADC) is used to display an approximate output voltage (~5mV resolution). Note that the voltage conversion assumes that the CB voltage is exactly 5.0V. Any deviation from this will cause an error in the displayed value.

Figure 4.1 Bridge and Temperature Display and Data Logging Screen (ZSC31010 Coefficients Shown)

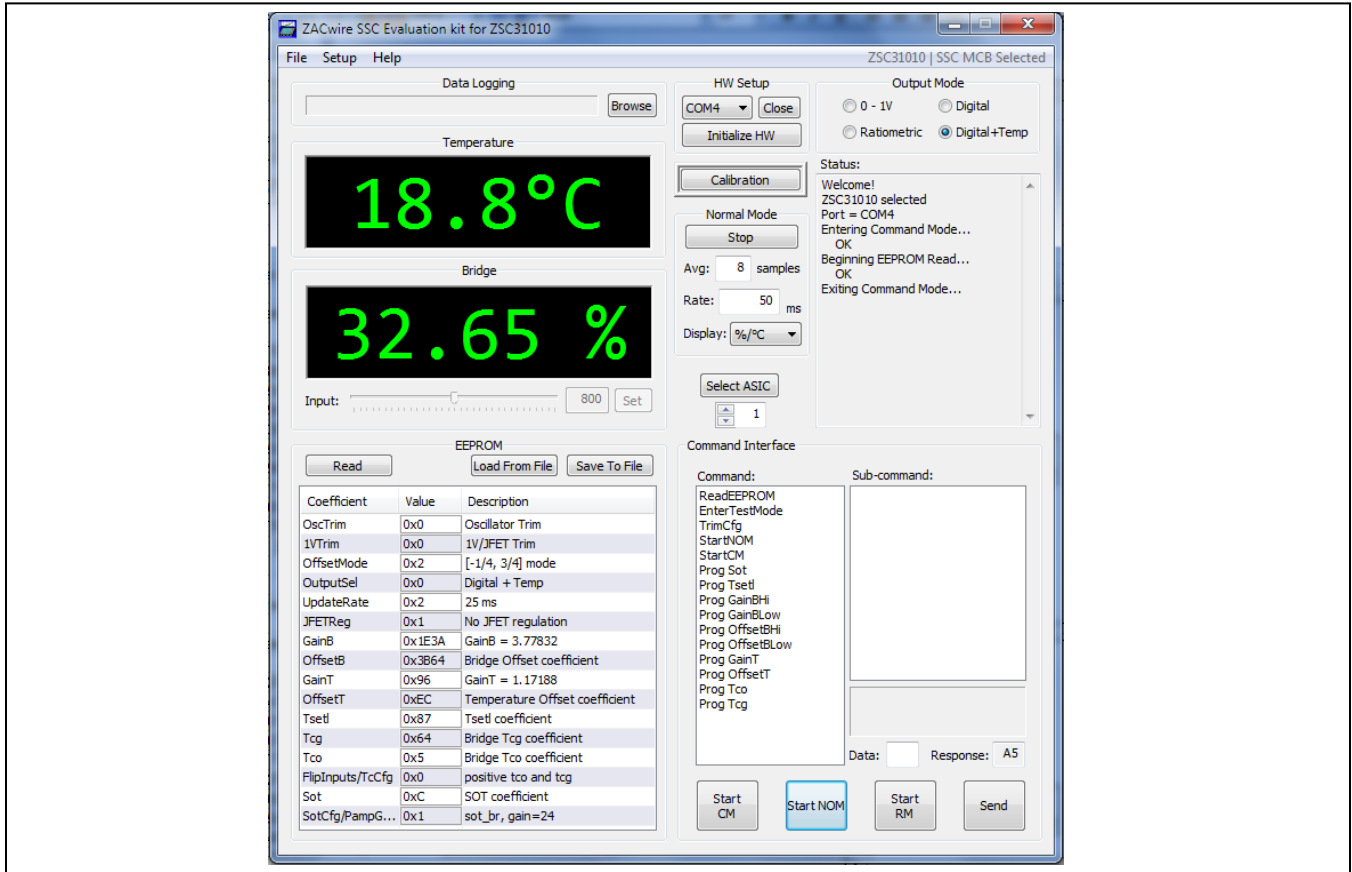

4.1.2. Data Logging Section

Bridge and temperature readings can be logged to a PC file. This feature is in the “Data Logging” section. Use the “Browse” button to select the filename and directory where the file will be stored. Then click “Open.” The sample “Rate” field sets how often the data is collected. If the sample rate is 0 sec, then an entry is written for each transmission from the DUT.

The resulting text file is a space-delimited ASCII file and can be imported into Microsoft Excel®.

4.1.3. EEPROM Section

When the “Read” button (see Figure 4.2.) is clicked, the “EEPROM” section displays all of the fields currently stored in the DUT EEPROM (non-volatile memory).

To save EEPROM settings to a file, click the “Save To File” button. All settings are saved in a user-selected xml file *.eep located in the *My Documents* folder under *ZMD\ZSC31010*, *ZMD\ZSC31015*, or *ZMD\ZSSC3015* depending on the “Select Product” setting described in section 3.3.

To load the default values file ([product name]_default_EEPROM.eep) or previously saved EEPROM settings (user-selected *.eep file), click on the “Load From File” button and browse for the file.

Note: The loaded file will not overwrite the trimming bits (OscTrim and 1VTrim/JFET_Trim for the ZSC31010; IV_Trim/JFET_Trim for the ZSC31015 and ZSSC3015), which are part-specific trimmed in the final test by IDT.

Figure 4.2 EEPROM Section Example (ZSC31010 Coefficients Shown)

The screenshot shows a window titled "EEPROM" with three buttons: "Read", "Load From File", and "Save To File". Below the buttons is a table with three columns: "Coefficient", "Value", and "Description".

Coefficient	Value	Description
OscTrim	0x0	Oscillator Trim
1VTrim	0x0	1V/JFET Trim
OffsetMode	0x2	[-1/4, 3/4] mode
OutputSel	0x0	Digital + Temp
UpdateRate	0x2	25 ms
JFETReg	0x1	No JFET regulation
GainB	0x1E3A	GainB = 3.77832
OffsetB	0x3B64	Bridge Offset coefficient
GainT	0x96	GainT = 1.17188
OffsetT	0xEC	Temperature Offset coefficient
TsetI	0x87	TsetI coefficient
Tcg	0x64	Bridge Tcg coefficient
Tco	0x5	Bridge Tco coefficient
FlipInputs/TcCfg	0x0	positive tco and tcg
Sot	0xC	SOT coefficient
SotCfg/PampG...	0x1	sot_br, gain=24

4.1.4. Command Interface Section

Use the “Command Interface” section to issue commands to the DUT. Descriptions for these commands can be found in the product datasheet. Click “START CM” (Start Command Mode) before sending any commands to the IC. This puts the IC into Command Mode, and the output values in the black display fields do not update. Only the set of commands valid for the selected product (ZSC31010, ZSC31015, or ZSSC3015) is active.

4.1.5. Response Field

If the DUT successfully enters Command Mode, it sends an A5_H response, which is displayed as A5 in the “Response” field.

4.1.6. Command/Subcommand/Data Fields

To send a command to the DUT, click on its text description in the “Command” section. If the command has a sub-command component, then also click the selected sub-command in the “Sub-Command” section. Some commands also require one or more hex digits of data. Enter these in the “Data” field.

4.1.7. Send Button

After the desired command and any applicable sub-command are selected and any applicable data has been entered, click “Send.”

4.1.8. Start CM Button

To start Command Mode for communication and calibration, click “START CM” (Start Command Mode).

4.1.9. Start NOM Button

To exit Command Mode and return the DUT to Normal Operation Mode (reading, conditioning, and transmitting bridge data), click “START NOM” (Start Normal Operation Mode).

4.1.10. Start RM Button

When in Raw Mode, the block display fields show the raw values (uncorrected ADC results) for bridge and temperature input signals if the bridge gain (Gain_B) is programmed to unity (800_H) and the temperature gain (Gain_T) is programmed to unity (80_H). The “Start RM” button is provided only as an option for control and analysis; it is not typically needed during a standard calibration run.

The Raw Mode can only be entered after entering the Command Mode.

The calibration section of the software will automatically put the DUT in Raw Mode and collect all the raw data needed for a given calibration point.

4.1.11. Normal Mode Section

Clicking on the “Collect Data” button collects either raw values or corrected output data depending on the EEPROM settings. If the DUT is programmed in analog output configuration, the software issues a request for analog conversion to the board. This function uses one of the 10-bit (~5mV resolution) ADC channels of the CB. The input to this ADC is connected to the SIGTM pin of the DUT. The result is displayed as a voltage. Note: When entering Normal Mode, data collection is started automatically.

“**Avg samples**” (Average Samples)

This feature allows averaging the measured values by choosing the number of samples to average before displaying the result. Note this is a running average, so increasing the number to average increases the display’s settling time but does not affect the update rate.

“Rate” in ms

This feature allows programming the timing of the data collection, which is especially useful for data logging over a long time. The minimum time is limited by the operating system of the user’s PC and/or the CB functions and is usually 10 to 20 ms.

4.1.12. Output Mode Section

In the “Output Mode” section, select the output mode before starting calibration. This selection determines the value range of the output signals as shown in the following table. Additional selections are possible in the “Calibration/Set ASIC Configuration” window (click “Calibration” to initialize).

Table 4.1 Output Mode Options

Input Values Chamber Readings	Output Values Depending on Output Selection		
Measurement Example (%)	Digital With/Without Temperature %(Digital)	Ratiometric Analog VDD=5V (V)	0-1V (V)
10%	10% (204)	0.5	0.1
50%	50%(1024)	2.5	0.5
90%	90%(1834)	4.5	0.9

4.1.13. Adjustment of the Analog Pre-Amp Gain and the Analog ADC Offset Modes

The offset parameter is calculated automatically during the calibration procedure, and the result is stored in the EEPROM.

There are 4 programmable offset modes for the ZSC31010/ZSC31015/ZSSC3015:

- [-1/2,1/2]
- [-1/4,3/4]
- [-1/8,7/8]
- [-1/16,15/16]

During the calibration process (“Add New Point”), the software will “acquire” data up to four different times, acquiring data once for each of the 4 different offset modes enabled. The best offset mode to use is calculated automatically by the software, and the result is stored in the EEPROM.

Once the user has a good understanding of the bridge and its performance, the user should choose to disable data acquisition in certain offset modes. This will expedite the calibration process because then data acquisition will not be needed in all 4 modes.

These analog offset modes help compensate for bridges that have a large inherent offset.

The [-1/2, 1/2] mode is best for a balanced bridge [-50mV, 50mV] @ VDD=5V (Pre-Amp=24).

The [-1/16, 15/16] mode is best for positive-skewed bridges [-10mV, 90mV] @VDD=5V (Pre-Amp=24).

The gain term stored in EEPROM used to compensate for span is a digital gain term (a digital number multiplied by the result of the ADC to compensate sensor span). Prior to ADC conversion, however, there is an amplifier (pre-amp). This amplifier amplifies the bridge signal to produce the differential signal converted by the ADC conversion. This amplifier can be programmed to one of four different settings as shown in Table 4.2.

Table 4.2 Programmable Pre-amp Gain Settings

ZSC31010	ZSC31015	ZSSC3015
A=6	A=6	A=6
A=12	A=24(default)	A=24(default)
A=24(default)	A=48	A=48
A=48	A=96	A=96

Any bridge input signal greater than 40mV/V in differential will saturate the pre-amp if the gain is set to 24 (default). In this case, the pre-amp gain must be set to the next lower value (12 for ZSC31010 or 6 for ZSC31015 and ZSSC3015).

For very small differential input signals, the higher analog gain (48) can improve the output resolution given in the “Analog Inputs versus Output Resolution” section of the datasheet, but the sensor offset must always be considered as well as sensor span. Both the offset and span of the sensor are amplified by the pre-amp. With a high analog gain (48) the total offset plus span cannot exceed 20mV/V differential. Otherwise the input to the ADC will be saturated.

The optimized AFE setting is supported by an Excel™ file *[product name]_AFE_Configuration_Selection_revX.X.xls*.

4.1.14. Calibration Button

To initiate a calibration run, click the “Calibration” button. This results in the calibration screen and dialog box shown in Figure 4.3.

Figure 4.3 Calibration Window Example (ZSC31010 Coefficients Shown)

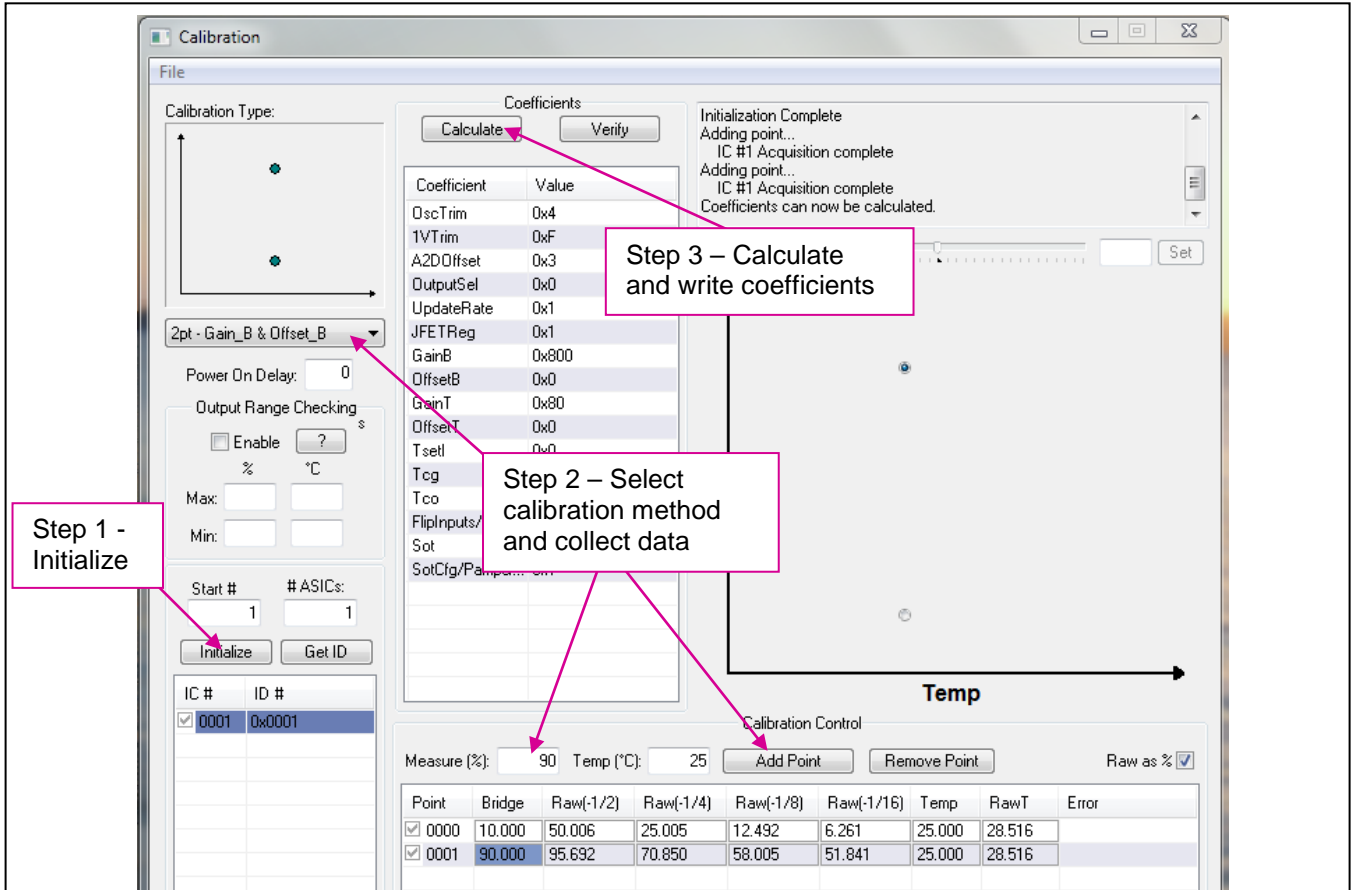

4.2. Calibration Sequence

Although the ZSC31010/ZSC31015/ZSSC3015 can function with many different types of resistive bridges, assume it is connected to a pressure bridge for the following calibration example. In this case, calibration essentially involves collecting raw bridge and temperature data from the IC for different known pressures (and temperatures if desired). This raw data can then be processed by the calibration master (the PC), and the calculated coefficients can then be written to the EEPROM of the IC.

The SSC Evaluation Kit software that IDT provides with the SSC Evaluation Kit is intended for demonstration purposes and calibration of single units. IDT can provide customers with algorithms and assistance in developing their full production calibration software.

There are three main steps to calibration:

1. Assigning a unique identification to the DUT. This identification is programmed in EEPROM and can be used as an index into the database stored on the calibration PC. This database will contain all the raw values of bridge readings and temperature readings for that part, as well as the known pressure [in %FS] and temperature [in deg C] to which the bridge was exposed.
2. Collecting data. Data collection involves getting raw data from the bridge at different known pressures and temperatures. This data is then stored on the calibration PC using the unique identification of the IC as the index into the database.
3. Calculating and writing coefficients to EEPROM. After enough data points have been collected to calculate all the desired coefficients, the coefficients can be calculated by the calibrating PC and written to the EEPROM of the IC.

Figure 4.4 ASIC ID Section for Initialization, Identification, and Adjustment (ZSC31010 Settings Shown)

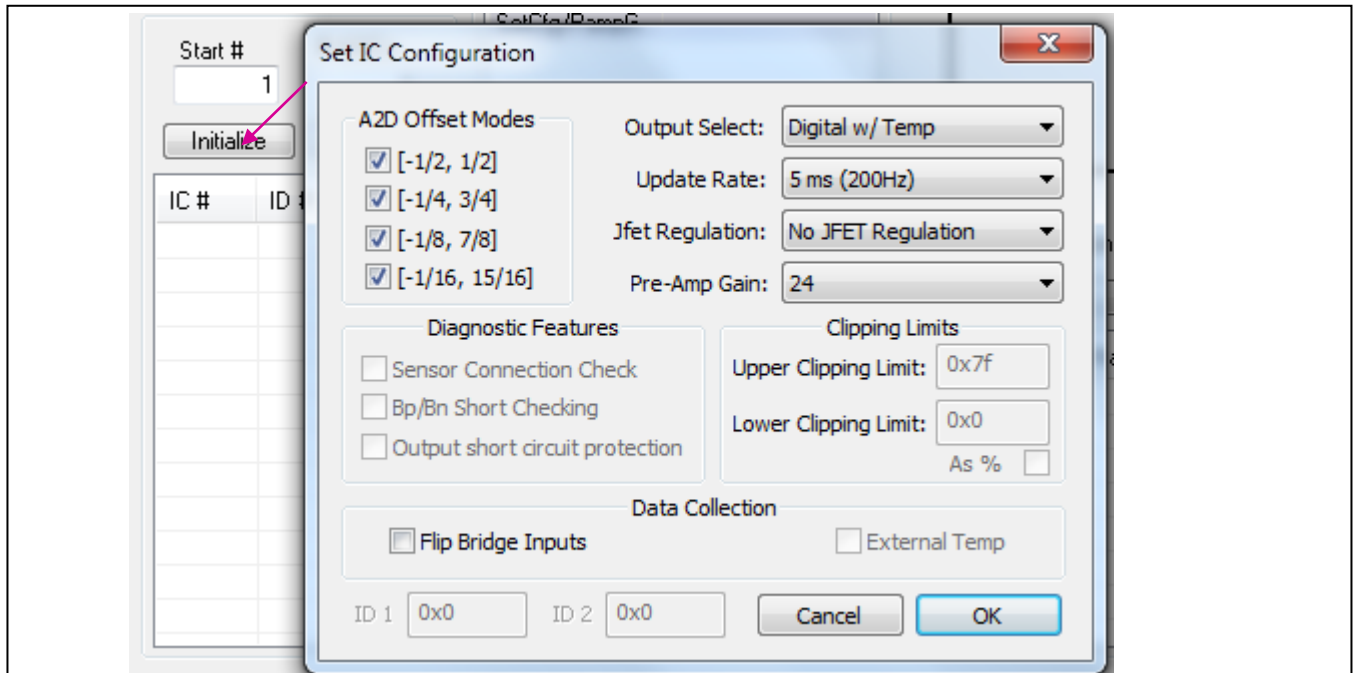

4.2.1. Step 1 – Assigning a Unique Identification (ASIC ID Section)

In the “ASIC ID” section in the bottom left corner of the calibration screen, click on “Initialize.” A dialog box (see Figure 4.4) results for selecting the part configuration. Complete the fields for Output Select, Update Rate, JFET Regulation, Pre-Amp Gain, and Flip Bridge Inputs to select the part configuration, and then click OK. Settings that are not available for the selected product are disabled. The part is assigned a unique ID, which is used as an index in the database. This unique ID is also programmed into registers in the EEPROM. If using the ZSSC3015 or ZSSC31015, the ID1 and ID2 fields can be used to set customer specific ID information. ID3 will then be used by the software to provide up to 255 unique IDs with the same ID1 and ID2 values.

Do not disable an ADC offset mode unless the mode will not be needed for the bridge being calibrated. If uncertain, leave all four modes checked. Disabling offset modes only saves time during calibration. For initial evaluations of the ZSC31010/ZSC31015/ZSSC3015, it is best to leave all four modes checked and let the calibration software decide which modes to use (see section 4.1.13).

A Pre-Amp gain of 24 is the default and sufficient for most bridges. Bridges that produce a large signal ($>40\text{mV/V}$ differential (max-min)) must use the lower gain setting of 12 for ZSC31010 or 6 for ZSC31015 and ZSSC3015. For bridges that have a small output signal ($<2\text{mV/V}$), using a higher gain setting of 48 will increase output resolution (see section 4.1.13).

4.2.2. Step 2 – Data Collection

Calibration Type Section with the Small Graph

The next step is selecting the type of calibration. The number of unique points (for this example, pressure and temperature points) at which calibration must be performed depends on the user's requirements. The minimum is a 2-point calibration, and the maximum is a 5-point calibration.

Under "Calibration Type" in the upper left section of the calibration screen (Figure 4.3), there is a smaller graph: X-axis = Temperature, Y-axis = Bridge (pressure for this example). This graph outlines the recommended spread of points (for this example, pressure and temperature) to be used for calibration.

→ **Choose the desired calibration type from the drop-down menu below the smaller graph.**

Place the bridge/IC pair to be calibrated in a controlled environment (for this example, pressure/temperature chamber), and stabilize the environment at the first desired calibration point.

Calibration Controls Section

- **Enter the temperature of the chamber (if applicable), as well as the desired read out (in %) of the DUT at this pressure.**
- **Click on "Add New Point."** The raw data (pressure and temperature) is obtained from the part, and the point is displayed on the large graph. It is graphed on the X-axis according to the raw temperature reading from the part, and on the Y-axis according to the % value entered in the previous step.
- **Change the pressure/temperature of the bridge/IC pair being calibrated and repeat. Take as many more points as needed.**

Hints:

For better calibration results, choose the temperature and read out (%) values as close as possible to the desired working range.

4.2.3. Step 3 – Calculate & Write Coefficients

After enough data points have been collected to calculate the calibration coefficients, the “Calculate” button becomes active. Click this button. The software calculates all the coefficients, writes them to EEPROM, and releases that index for future use. The bridge/IC pair is now calibrated. The software recalculates the desired output bridge values and displays the difference as an error for each point in the “error” column in this table. Additional points not included in the calibration can be added for validation. The software will display an error message if the calibration does not complete successfully.

For a full list of calibration-related error codes, see *ZACwire_SSC_Kit_App_Notes_Calibration_DLL+EXE_revX.X.pdf* (available on www.IDT.com; see section 8 for details).

4.3. Section Output Range Checking

Recommendation: Enable the output range check as shown in Figure 4.5 after entering the application specific output temperature range. The check interpolates the correction result at the temperature limits and checks that these results are inside the given bridge output range.

Figure 4.5 Section Output Range Checking

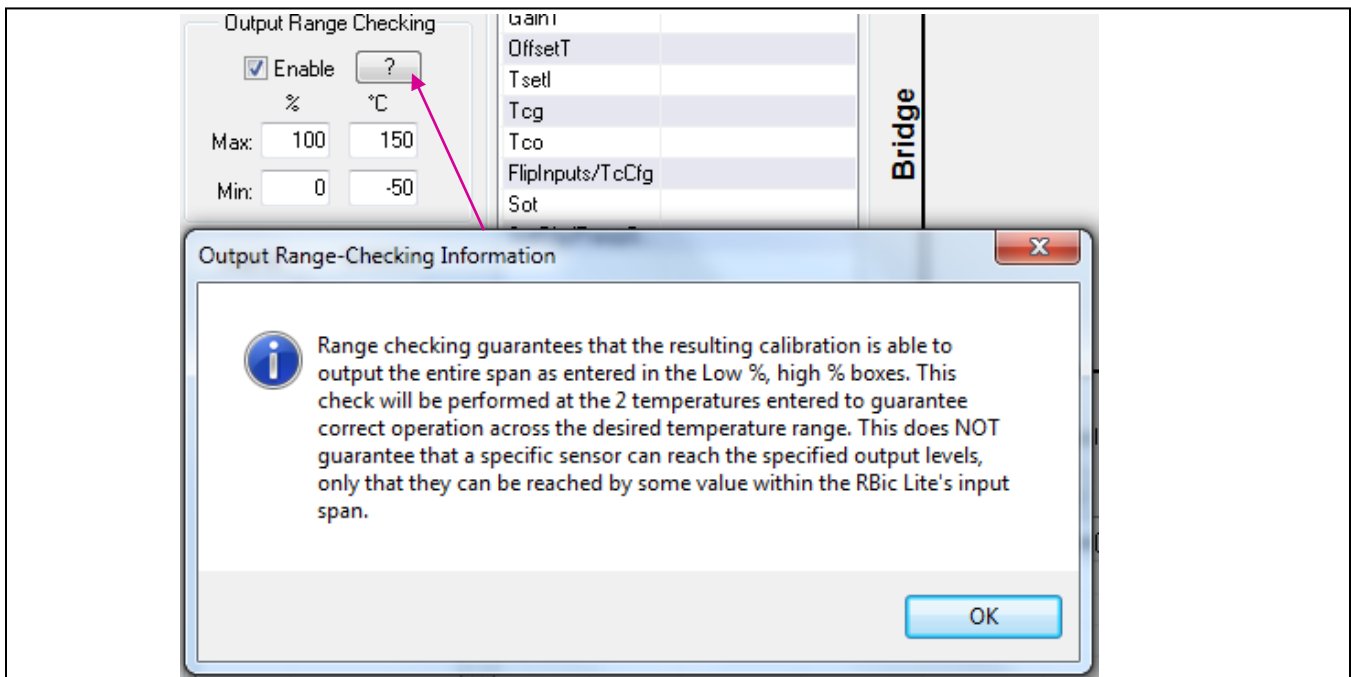

5 Dry Run Calibration

The following directions perform an example of a simple 2-point linear calibration using the SSC Sensor Replacement Board (SRB)^{*} and a DMM for measuring the sensor input values between pin 2 (VBP) and pin 4(VPN) of the DUT.

Steps for the Dry Run Calibration

- 1.) Connect the three boards: the SSC Communication (CB), SSC Evaluation Board, and the SRB. Insert the ZSC31010/ZSC31015/ZSSC3015 in the SOP-8 socket on the SSC Evaluation Board. The correct orientation for pin 1 is shown in Figure 2.1.
- 2.) Connect a USB cable from the USB connector on the SSC CB to an available USB port. Verify that the green PWR LED is lit on the SSC CB.
- 3.) Start the SSC Evaluation Kit software.
- 4.) Select "SSC Eval Kit" under "Board Type." Select the actual product (ZSC31010, ZSC31015, or ZSSC3015) under "Select Product." Select the proper COM port. Click on "Initialize Hardware."
- 5.) Click on "START CM." If the setup is correct, A5 is displayed in the "Response" field at the bottom right.
- 6.) Click on "Calibration." The calibration window appears (Figure 4.3).
- 7.) Click on "Initialize" in the ASIC ID section (lower left corner). A dialog box results. Choose "Ratiometric Analog" as the output selection; "25ms" as the update rate; "No JFET Regulation"; and "normal bridge inputs" (not flipped) and pre-amp gain =24. A unique identifier is assigned to this DUT and is written to its EEPROM. The EEPROM setting will be changed for reading raw values and displayed in the "Coefficient Section."
- 8.) In the upper left section of the calibration window, under "Calibration Type," choose "2-Pt Gain_B & Offset_B" calibration from the drop-down menu. The smaller graph above the drop-down menu indicates the recommended pattern of two bridge readings at the same temperature.
- 9.) The next step is to start data collection. Normally this would be done with a real bridge attached to the DUT on a remote board in a controlled environment. Instead, this dry run calibration uses the SRB as bridge inputs.
 - a. Turn the red potentiometer on the SRB all the way to the left (about 0 mV).
 - b. Enter 10% in the "Measure %" box in the "Calibration Controls" section.
 - c. Click on "Add New Point." The software obtains a raw reading from the part and graphs the new data point.
 - d. Turn the red potentiometer on the SRB all the way to the right (about 110mV).
 - e. Enter 90% in the "Measure %" box.
 - f. Click on "Add New Point" again. The software obtains a new raw reading from the part and graphs the new data point.
- 10.) Because this is a 2-point calibration, the software has all the necessary data for calculating and writing the coefficients. Click on "Calculate," which should now be active.
- 11.) Connect the voltmeter to the analog output. The output voltage will change now from 0.5V to 4.5V with a clockwise turn of the potentiometer.

^{*} For more information, see [ZSC3xxxx_SensorReplacementBoard_DS.pdf](#).

Figure 5.1 Example for a 2-Point Calibration (ZSC31010 Coefficients Shown)

The screenshot shows the 'Calibration' software window. On the left, the 'Calibration Type' is set to '2pt - Gain_B & Offset_B'. The 'Coefficients' table lists various parameters and their values. The 'Calibration Control' table shows two calibration points. A message box indicates that the calibration was successful and coefficients are now displayed. Annotations with arrows point to specific elements: 'Calibration was successful. Calculated coefficients are now displayed' points to the message box; '[-1/4, 3/4] mode was used' points to the 'Raw(-1/4)' column in the 'Calibration Control' table; and 'Enable if point is used for calibration' points to the checked checkbox in the 'Point' column of the 'Calibration Control' table.

Point	Bridge	Raw(-1/2)	Raw(-1/4)	Raw(-1/8)	Raw(-1/16)	Temp	RawT	Error
0000	10.000	50.195	25.195	12.695	6.445	25.000	27.051	-0.002
0001	90.000	99.994	80.383	67.887	61.652	25.000	27.051	0.002

Coefficient	Value
OscTrim	0x7
1VTrim	0x4
A2DOffset	0x2
OutputSel	0x0
UpdateRate	0x1
JFETReg	0x1
GainB	0xB99
OffsetB	0x344A
GainT	0x80
OffsetT	0x0
Tsetl	0x63
Tcg	0x0
Tco	0x0
FlipInputs/TcClg	0x0
Sot	0x0
SotClg/PampG...	0x5

6 Calculation of Calibration Coefficients Off-line

Note This calculation is possible without connecting the kit boards to the PC. Raw and target values can be entered manually or copied using the copy and paste function in Microsoft® Office from an Excel™ table for SSC Evaluation Kit software revisions 2.000 and higher. The values listed in a *CalibrationLog_DDMMYYYY.txt* file can also be entered.

Steps for the Off-line Calibration Coefficient Calculation:

- (1) Start the SSC Evaluation Kit software and select the product for which the coefficients should be calculated.
- (2) Click on “Calibrate.” The calibration window appears (see Figure 4.3).
- (3) Click on “Initialize” in the “Initialization” section (upper left corner). The “Set IC Configuration” window appears (see Figure 4.4). Click “OK.” The actual setting does not influence the off-line calibration.

Note: This is a “blind” initialization, because no part is connected.

- (4) Select the desired calibration method. The smaller graph above the pull down menu indicates the recommended pattern of bridge and temperature readings.
- (5) Start data collection. Fill in numbers in the “Point” column. The target and raw values can be written/copied in the related fields. The numbers are [%] for the bridge target and raw readings and [°C] for the temperature target and raw readings.
 - a. Click on “Add New Point.”
 - b. Enter the first target bridge reading [%] in the “sensor” field and enter the raw value [%] in the “raw” field. For calibration with temperature compensation, also add the chamber temperature in the “temp” field temperature and raw readings in the “rawT” fields.
 - c. Repeat a) and b) as needed until all calibration points are entered.
- (6) Check the “Valid” check box, and click on the “Calculate” button. The coefficients are stored in the *CalibrationLog_DDMMYYYY.txt* file.
- (7) Click “View Log” to open this file. For each calibration point, the error for the point is calculated in the same file.
- (8) Additionally, the calibration information can be exported to Microsoft Excel™ or to a Comma Separated Value (CSV) text file. To export the data, go to the File menu and select ‘Export Calibration Data’ and then either ‘Export to Microsoft Excel’ or ‘Export to CSV file.’

Note: Instead of entering the raw and target values for the bridge and temperature target and raw values, these values can be transferred from a *CalibrationLog_DDMMYYYY.txt file* or from an Excel™ file using the copy/paste feature. For the example given in Figure 6.1, the Excel™ table should have the number of columns shown in Table 6.1. To copy from or paste to the calibration points table, first click the mouse in the table area, and then type Ctrl+c to copy or Ctrl+v to paste. Important: Copy and paste operations operate on the entire table.

Table 6.1 Example Spreadsheet Data

Point	Bridge	Raw(-1/2)	Raw(-1/4)	Raw(-1/8)	Raw(-1/16)	Temp	Raw T
1	10.000	50.208	25.208	12.708	6.451	25.000	26.855
2	50.000	78.553	53.555	41.064	34.821	25.000	26.953
3	90.000	99.994	80.326	67.828	61.594	25.000	26.953

The number of A2D Offset modes selected during initialization determines the number of columns in Table 6.1.

The minimum number of points is determined by the selected calibration method. Additional points can be added. If the points are selected (check box enabled), they will be part of the calibration; otherwise these points will be used for error validation only.

Make sure that the Excel™ table includes only numbers in the correct format (Category: Number). Copying from formula results is not possible.

Figure 6.1 Fields for Manually Entering Target and Raw Values (ZSC31010 Coefficients Shown)

Warning: Calibration type does not support sensor input greater than 200% full scale. See datasheet-- 'SOT interpretation' for details
 IC #1 Calculation status: Success!
 IC #1 Programming status: Success!
 Calibration Complete
 See "CalibrationLog.txt" for details

Bridge Input: Set

Coefficient	Value
OscTrim	0x7
1VTrim	0x4
A2DOffset	0x2
OutputSel	0x0
UpdateRate	0x1
JFETReg	0x1
GainB	0x89D
OffsetB	0x3495
GainT	0x80
OffsetT	0x0
Tsetl	0x62
Tcg	0x0
Tco	0x0
Fliphnputs/TcCfg	0x0
Sot	0x21
SotCfg/PampG...	0x1

Calibration Control

Measure (%): 90 Temp (°C): 25 Raw as %

Point	Bridge	Raw(-1/2)	Raw(-1/4)	Raw(-1/8)	Raw(-1/16)	Temp	RawT	Error
<input checked="" type="checkbox"/> 0000	10.000	50.208	25.208	12.708	6.451	25.000	26.855	-0.015
<input checked="" type="checkbox"/> 0001	50.000	78.553	53.555	41.064	34.821	25.000	26.953	-0.049
<input checked="" type="checkbox"/> 0002	90.000	99.994	80.326	67.828	61.594	25.000	26.953	-0.107

Check box for calibration point selection

Target and raw values (e.g., copied from Excel™)

Validation error in calibration point (recalculation with calibration coefficients)

Note: The temperature output on ZSC31010, ZSC31015 and ZSSC3015 has a resolution of only 8 bits (200°C/256=0.8 °C), but the temperature dependency of the bridge input signal is corrected with an internal 12-bit temperature value. The validation error in the calibration points is typically due to rounding errors inherent in fixed-point mathematics (assuming a valid calibration with the minimum number of calibration points).

7 SSC Evaluation Kit Software with the IDT SSC Terminal

7.1. Protocol

The microcontroller (type ATmega32) on the SSC Communication Board (CB) enables communication with the SSC Evaluation Board and ZSC31010/ZSC31015/ZSSC3015 using the SSC Evaluation Kit software running on the PC. The serial ZACwire™ protocol is implemented in the microcontroller’s software. The USB_UART IC on the SSC CB transfers the signals from the microcontroller to the USB port of the PC.

For more details see *SSC_CommunicationBoard_VX-x_DataSheet_Rev_X_x.pdf*.

7.2. IDT SSC Terminal

The IDT SSC Terminal is the lowest level of communication for transferring commands from the PC to the microcontroller on the CB. For a full summary and detailed command description of the applicable controller commands, see the spreadsheet *SSC_CommunicationBoard_CommandSyntax_Rev_X_x.xls*, which is included in the software zip file described below.

The SSC Terminal software can be downloaded from the IDT website (<http://www.IDT.com>).

Navigate to www.IDT.com/SSC-COMM-BD. Click on the link titled “SSC Terminal Program Rev. x” (where x is the current revision) and follow the dialog instructions as needed to download the zip file for the software and then extract the *SSC Terminal Vx.exe* file. Then double click this file, which will create a *ZMDI SSC Terminal* icon on the PC desktop. Click on this icon to activate the terminal program.

Table 7.1 SSC Terminal Command Format

	Character Order					
	1	2	3	4,5	6,7,8	<d...d>
ZSC31010/ ZSC31015/ ZSSC3015	R	R or W	T or _	00		
Comments		Read or Write	Trigger Power Cycle or Not	Always 00	Number of Bytes to Read and Write	Blank for Read; Data Bytes to Write
Example	R	W	T	00	002	5000

Hint: If “T” is sent for the 3rd position (instead of “_”), the DUT is powered off and then on. “T” should be used only if power cycling is necessary for operation.

Figure 7.1 below shows a communication example. Write the command in the input line, and press ENTER on the keyboard or click on “Send.” See the current version of the data sheet for the ZSC31010/ZSC31015/ZSSC3015 for more details on commands.

Figure 7.1 SSC Terminal Example

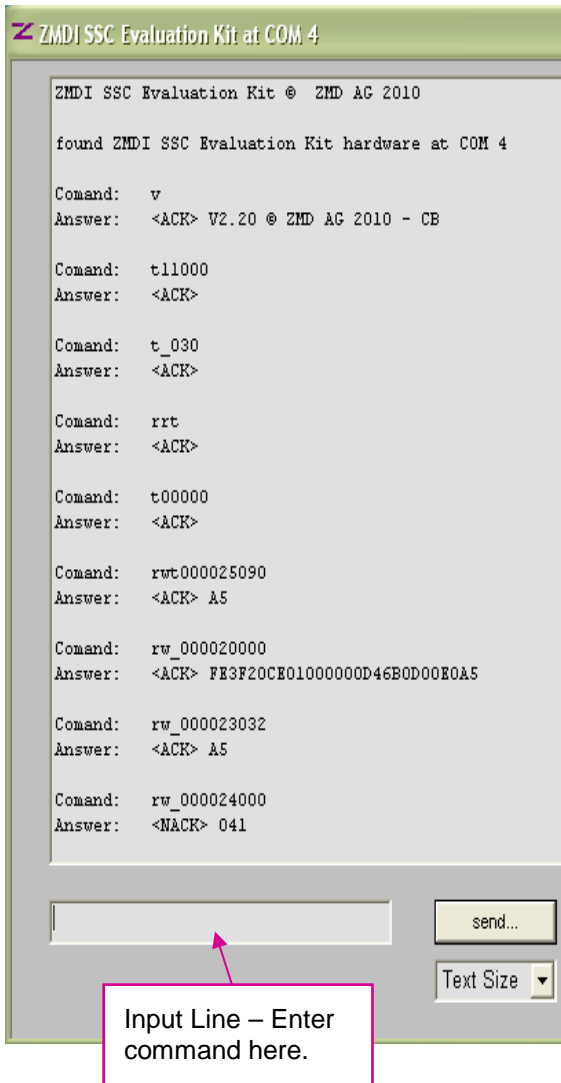

- v** Readout of SSC CB's firmware version
- t11000** Set trigger timing for 5V, 12V to 0ms
Note: The trigger delay must be set!
- t_030** Set timing for switching supply off to 30ms off before trigger restarts IC
- rrt** PowerOn using defined trigger
- t00000** Switches off 5V and 12V channels with trigger time preserved
- rwt000025090** Start Command Mode with power on using defined delay between power-on and start of communication *
- rw_000020000** Read EEPROM *
- rw_000023032** Set output mode to ratiometric (See data sheet for command details.)*
- rw_000024000** Start Normal Operation Mode

***Note:** The Start_CM command example shown in Figure 7.1 (5090_{HEX}) is valid for all products; however, for the ZSC31010, the two LSBs of Start_CM command can be any value. The only difference for a ZSC31015 or ZSSC3015 communication example is the number of EEPROM bytes returned for an EEPROM read command. ZSC31015 and ZSSC3015 will return 20 bytes, and ZSC31010 will return 14 bytes.

8 Related Documents

Documents Related to All Products
<i>SSC Communication Board Datasheet</i>
<i>SSC Sensor Replacement Board Datasheet</i>
<i>SSC Communication Board Driver Installation Application Note</i>
<i>SSC Evaluation Kits Feature Sheet (includes ordering codes and price information)</i>
<i>Communication Board Command Syntax Spreadsheet for ZSC31xxx and ZSSC3xxx Products</i>
<i>SSC Technical Notes - Calibration Sequence, DLL and EXE</i>
ZSC31010 Documents (www.IDT.com/ZSC31010)
<i>ZSC31010 RBiC_{Lite}TM Datasheet</i>
<i>ZSC31010 RBiC_{Lite}TM Errata Sheet</i>
<i>ZSC31010 RBiC_{Lite}TM Technical Notes - Die Dimensions and Pad Coordinates</i>
<i>ZSC31010 RBiC_{Lite}TM AFE Configuration Selection Spreadsheet</i>
ZSC31015 Documents (www.IDT.com/ZSC31015)
<i>ZSC31015 RBiC_{dLite}TM Datasheet</i>
<i>ZSC31015 RBiC_{dLite}TM Errata Sheet</i>
<i>ZSC31015 RBiC_{dLite}TM Technical Notes - Die Dimensions and Pad Coordinates</i>
<i>ZSC31015 RBiC_{dLite}TM AFE Configuration Selection Spreadsheet</i>
ZSSC3015 Documents (www.IDT.com/ZSSC3015)
<i>ZSSC3015 RBiCdLiteTM Datasheet</i>
<i>ZSSC3015 RBiCdLiteTM Technical Notes - Die Dimensions and Pad Coordinates</i>
<i>ZSSC3015 RBiCdLiteTM AFE Configuration Selection Spreadsheet</i>

Visit our website at www.IDT.com or contact your nearest sales office for the latest version of these documents.

Note: Documents can be found on our IDT webpage for the product as noted above or on www.IDT.com/SSC-COMM-BD.

9 Definitions of Acronyms

Term	Description
AFE	Analog Front-End
CB	SSC Communication Board
NOM	Normal Operation Mode
RM	Raw Mode
SOT	Second Order Term
SRB	SSC Sensor Replacement Board
SSC	Sensor Signal Conditioner

10 Document Revision History

Revision	Date	Description
1.40	June 16, 2010	Folder changes for software installation and saving the corresponding text files; Revised web address and sales contacts.
1.50	July 28, 2010	Revision of product name from ZMD31010 to ZSC31010.
1.60	December 14, 2010	Changed description/figure according to the new combined software covering both ZSC31010 and ZSC31015. Removal of references to <i>caldata.txt</i> , <i>DataLog.txt</i> , and <i>SavedSettings</i> files. Added filenames for default values files. Combined previous section 4.2.4 (“EEPROM Section”) with section 4.1.6. Replaced instructions for installing virtual COM port USB drivers with a referral to <i>SSC_AN_Communication Board_Driver_Installation_Rev_X_x.pdf</i> for directions. Removed Appendix B error code list and added references to <i>ZSC31010_RBic_Lite_App_Notes_Calibration_DLL+EXE_revX.X.pdf</i> .
1.70	March 23, 2011	Revisions to rename kit as the ZACwire™ SSC Modular Evaluation Kit. Reorganized sections 2 and 3. Updated schematic of Evaluation Board.
1.80	July 21, 2011	Added the ZSSC3008 to the list of products that can use the kit and modified text to reflect the differences for the ZSSC3008. Related file paths have changed. Revised Evaluation Board schematic for 31015/3008 External Temp pin. Added information on exporting calibration data to Excel™ or CSV file. Revised section 4.1.1 to add requirements for CB voltage in analog output mode. In section 4.1.11, revised the typical rate time range and revised the resolution for the ADC channels on the CB from 5mV to ~5mV. Edits for clarity in section 4.1.12. Updated values in Table 6.1. Updated illustrations of software. Edits for clarity in text related to rounding errors in section 6.

Revision	Date	Description
1.81	September 24, 2012	Update for contact information.
2.00	April 18, 2013	Removal of ZSSC3008. Addition of ZSSC3015. Update instructions for software installation. Update for contacts and imagery for cover and headers.
	April 26, 2016	Changed to IDT branding.

Appendix A: Schematic ZSC31010 SSC Evaluation Board[†]

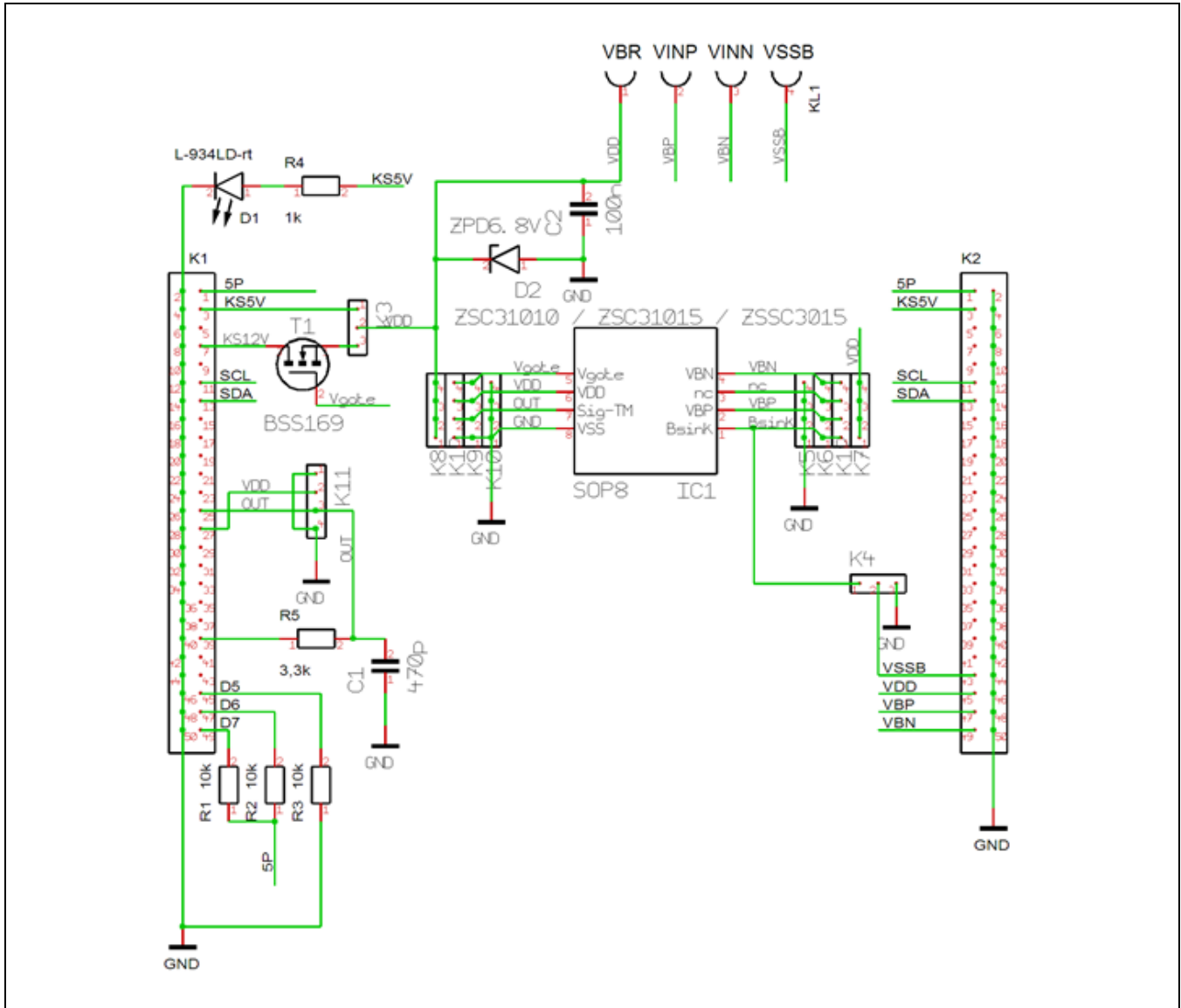

[†] Note that the nc pin shown on IC1 is the ExtTemp pin for the ZSC31015 and ZSSC3015.

Notice

1. Descriptions of circuits, software and other related information in this document are provided only to illustrate the operation of semiconductor products and application examples. You are fully responsible for the incorporation or any other use of the circuits, software, and information in the design of your product or system. Renesas Electronics disclaims any and all liability for any losses and damages incurred by you or third parties arising from the use of these circuits, software, or information.
2. Renesas Electronics hereby expressly disclaims any warranties against and liability for infringement or any other claims involving patents, copyrights, or other intellectual property rights of third parties, by or arising from the use of Renesas Electronics products or technical information described in this document, including but not limited to, the product data, drawings, charts, programs, algorithms, and application examples.
3. No license, express, implied or otherwise, is granted hereby under any patents, copyrights or other intellectual property rights of Renesas Electronics or others.
4. You shall be responsible for determining what licenses are required from any third parties, and obtaining such licenses for the lawful import, export, manufacture, sales, utilization, distribution or other disposal of any products incorporating Renesas Electronics products, if required.
5. You shall not alter, modify, copy, or reverse engineer any Renesas Electronics product, whether in whole or in part. Renesas Electronics disclaims any and all liability for any losses or damages incurred by you or third parties arising from such alteration, modification, copying or reverse engineering.
6. Renesas Electronics products are classified according to the following two quality grades: "Standard" and "High Quality". The intended applications for each Renesas Electronics product depends on the product's quality grade, as indicated below.
 - "Standard": Computers; office equipment; communications equipment; test and measurement equipment; audio and visual equipment; home electronic appliances; machine tools; personal electronic equipment; industrial robots; etc.
 - "High Quality": Transportation equipment (automobiles, trains, ships, etc.); traffic control (traffic lights); large-scale communication equipment; key financial terminal systems; safety control equipment; etc.Unless expressly designated as a high reliability product or a product for harsh environments in a Renesas Electronics data sheet or other Renesas Electronics document, Renesas Electronics products are not intended or authorized for use in products or systems that may pose a direct threat to human life or bodily injury (artificial life support devices or systems; surgical implantations; etc.), or may cause serious property damage (space system; undersea repeaters; nuclear power control systems; aircraft control systems; key plant systems; military equipment; etc.). Renesas Electronics disclaims any and all liability for any damages or losses incurred by you or any third parties arising from the use of any Renesas Electronics product that is inconsistent with any Renesas Electronics data sheet, user's manual or other Renesas Electronics document.
7. No semiconductor product is absolutely secure. Notwithstanding any security measures or features that may be implemented in Renesas Electronics hardware or software products, Renesas Electronics shall have absolutely no liability arising out of any vulnerability or security breach, including but not limited to any unauthorized access to or use of a Renesas Electronics product or a system that uses a Renesas Electronics product. RENESAS ELECTRONICS DOES NOT WARRANT OR GUARANTEE THAT RENESAS ELECTRONICS PRODUCTS, OR ANY SYSTEMS CREATED USING RENESAS ELECTRONICS PRODUCTS WILL BE INVULNERABLE OR FREE FROM CORRUPTION, ATTACK, VIRUSES, INTERFERENCE, HACKING, DATA LOSS OR THEFT, OR OTHER SECURITY INTRUSION ("Vulnerability Issues"). RENESAS ELECTRONICS DISCLAIMS ANY AND ALL RESPONSIBILITY OR LIABILITY ARISING FROM OR RELATED TO ANY VULNERABILITY ISSUES. FURTHERMORE, TO THE EXTENT PERMITTED BY APPLICABLE LAW, RENESAS ELECTRONICS DISCLAIMS ANY AND ALL WARRANTIES, EXPRESS OR IMPLIED, WITH RESPECT TO THIS DOCUMENT AND ANY RELATED OR ACCOMPANYING SOFTWARE OR HARDWARE, INCLUDING BUT NOT LIMITED TO THE IMPLIED WARRANTIES OF MERCHANTABILITY, OR FITNESS FOR A PARTICULAR PURPOSE.
8. When using Renesas Electronics products, refer to the latest product information (data sheets, user's manuals, application notes, "General Notes for Handling and Using Semiconductor Devices" in the reliability handbook, etc.), and ensure that usage conditions are within the ranges specified by Renesas Electronics with respect to maximum ratings, operating power supply voltage range, heat dissipation characteristics, installation, etc. Renesas Electronics disclaims any and all liability for any malfunctions, failure or accident arising out of the use of Renesas Electronics products outside of such specified ranges.
9. Although Renesas Electronics endeavors to improve the quality and reliability of Renesas Electronics products, semiconductor products have specific characteristics, such as the occurrence of failure at a certain rate and malfunctions under certain use conditions. Unless designated as a high reliability product or a product for harsh environments in a Renesas Electronics data sheet or other Renesas Electronics document, Renesas Electronics products are not subject to radiation resistance design. You are responsible for implementing safety measures to guard against the possibility of bodily injury, injury or damage caused by fire, and/or danger to the public in the event of a failure or malfunction of Renesas Electronics products, such as safety design for hardware and software, including but not limited to redundancy, fire control and malfunction prevention, appropriate treatment for aging degradation or any other appropriate measures. Because the evaluation of microcomputer software alone is very difficult and impractical, you are responsible for evaluating the safety of the final products or systems manufactured by you.
10. Please contact a Renesas Electronics sales office for details as to environmental matters such as the environmental compatibility of each Renesas Electronics product. You are responsible for carefully and sufficiently investigating applicable laws and regulations that regulate the inclusion or use of controlled substances, including without limitation, the EU RoHS Directive, and using Renesas Electronics products in compliance with all these applicable laws and regulations. Renesas Electronics disclaims any and all liability for damages or losses occurring as a result of your noncompliance with applicable laws and regulations.
11. Renesas Electronics products and technologies shall not be used for or incorporated into any products or systems whose manufacture, use, or sale is prohibited under any applicable domestic or foreign laws or regulations. You shall comply with any applicable export control laws and regulations promulgated and administered by the governments of any countries asserting jurisdiction over the parties or transactions.
12. It is the responsibility of the buyer or distributor of Renesas Electronics products, or any other party who distributes, disposes of, or otherwise sells or transfers the product to a third party, to notify such third party in advance of the contents and conditions set forth in this document.
13. This document shall not be reprinted, reproduced or duplicated in any form, in whole or in part, without prior written consent of Renesas Electronics.
14. Please contact a Renesas Electronics sales office if you have any questions regarding the information contained in this document or Renesas Electronics products.

(Note1) "Renesas Electronics" as used in this document means Renesas Electronics Corporation and also includes its directly or indirectly controlled subsidiaries.

(Note2) "Renesas Electronics product(s)" means any product developed or manufactured by or for Renesas Electronics.

(Disclaimer Rev.5.0-1)

Corporate Headquarters

TOYOSU FORESIA, 3-2-24 Toyosu,
Koto-ku, Tokyo 135-0061, Japan
www.renesas.com

Trademarks

Renesas and the Renesas logo are trademarks of Renesas Electronics Corporation. All trademarks and registered trademarks are the property of their respective owners.

Contact Information

For further information on a product, technology, the most up-to-date version of a document, or your nearest sales office, please visit:
www.renesas.com/contact/