

To our customers,

Old Company Name in Catalogs and Other Documents

On April 1st, 2010, NEC Electronics Corporation merged with Renesas Technology Corporation, and Renesas Electronics Corporation took over all the business of both companies. Therefore, although the old company name remains in this document, it is a valid Renesas Electronics document. We appreciate your understanding.

Renesas Electronics website: <http://www.renesas.com>

April 1st, 2010
Renesas Electronics Corporation

Issued by: Renesas Electronics Corporation (<http://www.renesas.com>)

Send any inquiries to <http://www.renesas.com/inquiry>.

Notice

1. All information included in this document is current as of the date this document is issued. Such information, however, is subject to change without any prior notice. Before purchasing or using any Renesas Electronics products listed herein, please confirm the latest product information with a Renesas Electronics sales office. Also, please pay regular and careful attention to additional and different information to be disclosed by Renesas Electronics such as that disclosed through our website.
2. Renesas Electronics does not assume any liability for infringement of patents, copyrights, or other intellectual property rights of third parties by or arising from the use of Renesas Electronics products or technical information described in this document. No license, express, implied or otherwise, is granted hereby under any patents, copyrights or other intellectual property rights of Renesas Electronics or others.
3. You should not alter, modify, copy, or otherwise misappropriate any Renesas Electronics product, whether in whole or in part.
4. Descriptions of circuits, software and other related information in this document are provided only to illustrate the operation of semiconductor products and application examples. You are fully responsible for the incorporation of these circuits, software, and information in the design of your equipment. Renesas Electronics assumes no responsibility for any losses incurred by you or third parties arising from the use of these circuits, software, or information.
5. When exporting the products or technology described in this document, you should comply with the applicable export control laws and regulations and follow the procedures required by such laws and regulations. You should not use Renesas Electronics products or the technology described in this document for any purpose relating to military applications or use by the military, including but not limited to the development of weapons of mass destruction. Renesas Electronics products and technology may not be used for or incorporated into any products or systems whose manufacture, use, or sale is prohibited under any applicable domestic or foreign laws or regulations.
6. Renesas Electronics has used reasonable care in preparing the information included in this document, but Renesas Electronics does not warrant that such information is error free. Renesas Electronics assumes no liability whatsoever for any damages incurred by you resulting from errors in or omissions from the information included herein.
7. Renesas Electronics products are classified according to the following three quality grades: “Standard”, “High Quality”, and “Specific”. The recommended applications for each Renesas Electronics product depends on the product’s quality grade, as indicated below. You must check the quality grade of each Renesas Electronics product before using it in a particular application. You may not use any Renesas Electronics product for any application categorized as “Specific” without the prior written consent of Renesas Electronics. Further, you may not use any Renesas Electronics product for any application for which it is not intended without the prior written consent of Renesas Electronics. Renesas Electronics shall not be in any way liable for any damages or losses incurred by you or third parties arising from the use of any Renesas Electronics product for an application categorized as “Specific” or for which the product is not intended where you have failed to obtain the prior written consent of Renesas Electronics. The quality grade of each Renesas Electronics product is “Standard” unless otherwise expressly specified in a Renesas Electronics data sheets or data books, etc.
 - “Standard”: Computers; office equipment; communications equipment; test and measurement equipment; audio and visual equipment; home electronic appliances; machine tools; personal electronic equipment; and industrial robots.
 - “High Quality”: Transportation equipment (automobiles, trains, ships, etc.); traffic control systems; anti-disaster systems; anti-crime systems; safety equipment; and medical equipment not specifically designed for life support.
 - “Specific”: Aircraft; aerospace equipment; submersible repeaters; nuclear reactor control systems; medical equipment or systems for life support (e.g. artificial life support devices or systems), surgical implantations, or healthcare intervention (e.g. excision, etc.), and any other applications or purposes that pose a direct threat to human life.
8. You should use the Renesas Electronics products described in this document within the range specified by Renesas Electronics, especially with respect to the maximum rating, operating supply voltage range, movement power voltage range, heat radiation characteristics, installation and other product characteristics. Renesas Electronics shall have no liability for malfunctions or damages arising out of the use of Renesas Electronics products beyond such specified ranges.
9. Although Renesas Electronics endeavors to improve the quality and reliability of its products, semiconductor products have specific characteristics such as the occurrence of failure at a certain rate and malfunctions under certain use conditions. Further, Renesas Electronics products are not subject to radiation resistance design. Please be sure to implement safety measures to guard them against the possibility of physical injury, and injury or damage caused by fire in the event of the failure of a Renesas Electronics product, such as safety design for hardware and software including but not limited to redundancy, fire control and malfunction prevention, appropriate treatment for aging degradation or any other appropriate measures. Because the evaluation of microcomputer software alone is very difficult, please evaluate the safety of the final products or system manufactured by you.
10. Please contact a Renesas Electronics sales office for details as to environmental matters such as the environmental compatibility of each Renesas Electronics product. Please use Renesas Electronics products in compliance with all applicable laws and regulations that regulate the inclusion or use of controlled substances, including without limitation, the EU RoHS Directive. Renesas Electronics assumes no liability for damages or losses occurring as a result of your noncompliance with applicable laws and regulations.
11. This document may not be reproduced or duplicated, in any form, in whole or in part, without prior written consent of Renesas Electronics.
12. Please contact a Renesas Electronics sales office if you have any questions regarding the information contained in this document or Renesas Electronics products, or if you have any other inquiries.

(Note 1) “Renesas Electronics” as used in this document means Renesas Electronics Corporation and also includes its majority-owned subsidiaries.

(Note 2) “Renesas Electronics product(s)” means any product developed or manufactured by or for Renesas Electronics.

Diode

Precautions for Application

1. Selecting a Semiconductor Device

The reliability of semiconductor devices is not limited to Renesas products alone, but is dependent on other factors including electronic equipment firms, and a variety of application conditions including the circuit conditions selected by the user, mounting and environmental conditions. To assure the kind of usage that gives a high level of reliability, please consider the maximum ratings, deratings and selection of package when choosing a device.

1.1 Maximum Ratings

The maximum ratings of a semiconductor device are usually defined in terms of the “absolute maximum ratings”, and should not be exceeded under any circumstances, even for an instant.

Even momentary excess of these maximum ratings can lead to immediate deterioration or destruction of the device concerned. Even if the device operates for a while after the excess, it must be assumed that the operation life has been shortened considerably.

In designing electronic circuits with semiconductor devices, the first step to circuit design is to make sure that their maximum ratings are never exceeded, no matter what electrical fluctuations due to external conditions may occur.

Not only the DC maximum ratings but in the case of pulse type applications as well, the area of safe operation (ASO), load locus and peak voltage current should also not be exceeded.

(1) Diode maximum ratings

A description of Renesas diode maximum ratings are given in the “Renesas Diode Symbols and Their Definitions” section of this data book.

(2) Area of Safe Operation (ASO)

As opposed to the absolute maximum ratings, the ASO ratings indicate the maximum ratings in the operating state. However, since the mutual interactions between the voltages, currents, ambient temperature, and other conditions result in different combinations of conditions that can be used, these issues require careful consideration.

(3) Derating considerations

The degree of derating that can be applied to particular maximum ratings is an important aspect of reliability design. Derating characteristics of semiconductor devices has been dealt with previously in this data book. At the system design stage, the derating values each vary slightly with the device type: these include electrical stress derating such as voltage, current, power and load, and mechanical stress derating such as vibration and shock.

Table 1 shows examples of derating criteria that should be considered in reliability design.

It is advisable to consider these derating criteria for assurance of reliability in the design of equipment. If setting within the derating criteria is problematic, another method, for example, selection of a device with greater maximum ratings, is advised.

Table 1 Derating Design Criteria Example

Derating Factor		Diode	(Precaution for Application)
Temperature	Junction temperature	$(T_j - 25^\circ\text{C}) \times 0.5 + 25^\circ\text{C}$ or less ex.) ($T_j = 175^\circ\text{C} \rightarrow 100^\circ\text{C}$ or less)	(Especially for high-reliability applications)
	Device ambient temperature	— ($T_a = 5$ to 35°C)	(Especially for high-reliability applications)
	Others	Power dissipation, ambient temperature, heat radiation conditions $T_j = P_d \times R_{th(j-a)} + T_a$	
Humidity	Relative humidity	45 to 75% RH	
	Others	When condensation forms due to normal temperature, sudden temperature change etc., semiconductors and PCBs should be coated with a waterproof.	
Voltage	Voltage withstanding	Maximum rating $\times 0.8$ or less (maximum rating $\times 0.5$ or less)	(Especially for high-reliability applications)
	Over-voltage	Prevention measures against over-voltage including static electricity destruction	
Current	Average current	$I_o \times 0.5$ or less ($I_o \times 0.25$ or less)	(Especially for high-reliability applications)
	Peak current	$I_{FM} [I_{F(\text{peak})}] \times 0.8$ or less	
Power	Average power	$P_d \times 0.5$ (especially for Zener diodes)	
Pulse ^{*1}	ASO	Individual catalog maximum rating value of should not be exceeded.	
	Surge	$I_{FSM} [I_{F(\text{surge})}]$ or less	

Note: 1. In general, peak voltage (including surge), current power and junction temperature should be below the maximum ratings to guard against excess states, and deratings for reliability should be in accordance with the above average values. Please consult Renesas technical staff with regard to the ASO, as this varies with the circuit the device is used in.

2. Precautions for Mounting

Certain precautions must be observed with regard to structural design or mounting work in semiconductor device assembly and mounting. The following is a description of the precautions it is advisable to observe during design and handling. The method of attachment and mounting should follow the precautions harm the reliability of semiconductor devices.

2.1 Forming and Cutting Leads

When mounting an insertion type diode in a printed circuit board, leads may have to be formed to cut. Mechanical destruction of a device may occur or the life of the device may be shortened if unnecessary stress is applied to leads during these processes. In the worst case, the glass body of the diode can crack, so the following precautions should be taken when forming or cutting leads.

- (1) When bending lead wires, hold them securely between the glass body and the point to be bent with a pair of pliers. Then bend them holding the open end of the lead so that no bending stress is applied to the glass body as illustrated in figure 1A. Never bend the leads while holding the glass body.
The same precaution should be taken when the leads of multiple devices are processed simultaneously using lead forming machines (see figure 1B).
- (2) The bend in the lead wires should be made away from the end of the glass body (see figure 1C). Do not bend the lead wires more than 90° .
- (3) Do not bend the leads repeatedly.

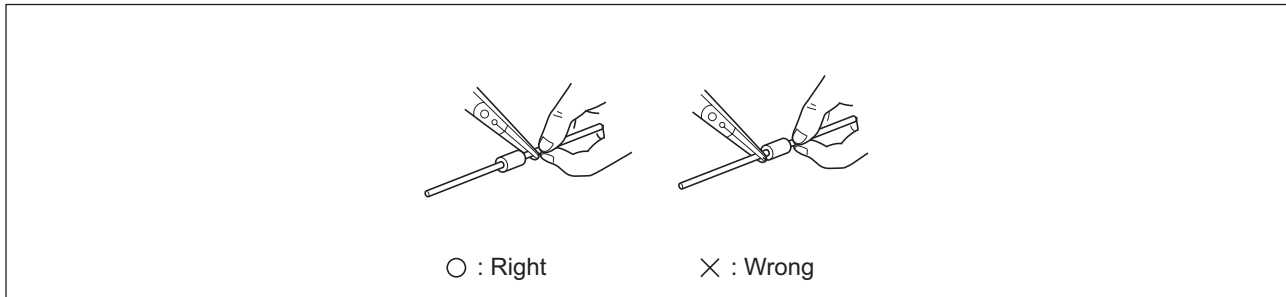

A) Lead bending

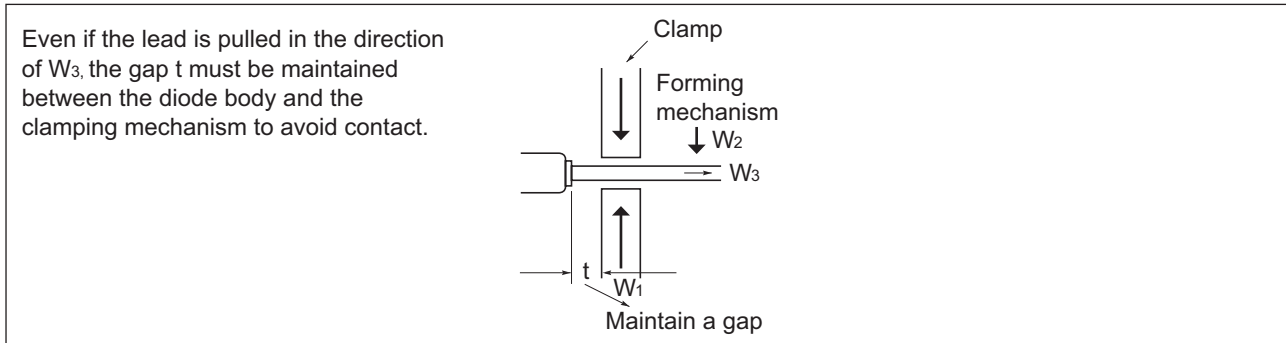

B) Bending a lead wire using a die

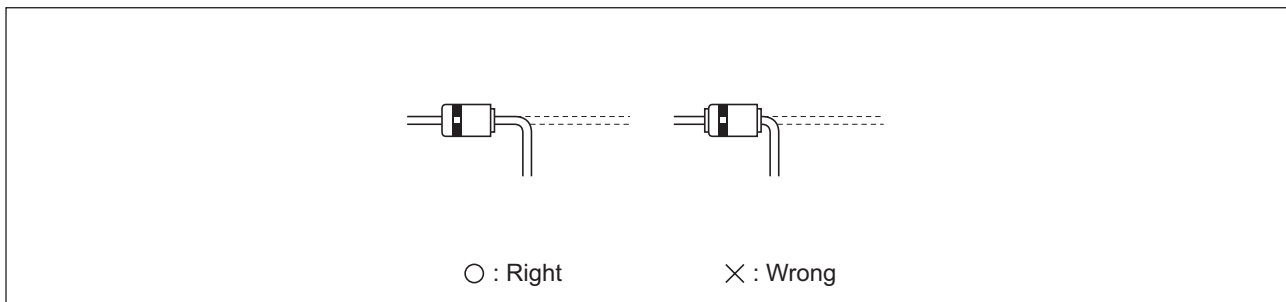

C) Bending point

Figure 1 Precautions for Lead Forming

Example Case Name	Package destruction due to automated insertion
Device Type	Glass-sealed type diode
Example Contents	<p>During automatic insertion of the diode in a PCB using a high-speed inserter, the glass package was destroyed by excessive pressing force on the diode body and/or excessive force from the lead clinch in the PCB.</p>
Countermeasures	<ol style="list-style-type: none"> 1) Adjust the position of the presser mechanism (die). Use a die material that buffers the shock on the diode glass. 2) Set the lead clinch force to the minimum.

Figure 2 Package Destruction Due to Automated Insertion

2.2 Attachment to a Printed Circuit Board

When attaching a semiconductor device to a printed circuit board, make sure the lead wires are not subjected to excessive stress.

Take the following precautions:

- (1) The gap between attachment holes in the PCB should match the gap between lead wires to make sure that excessive stress is not applied either during insertion of the device or afterwards.
- (2) When attaching a device to a PCB, do not pull unnecessarily on the lead wires to avoid excessive stress build up between the lead wires and package.
- (3) Leave a suitable gap between the semiconductor device and the PCB. It is advisable to use spacers or similar means to achieve this.
- (4) After fixing to the PCB, do not carry out assembly operations that are likely to cause stress between lead wires and the device body. For example, after soldering lead wires to the PCB, if the device is attached to a heat sink, variance in lead wire length tolerance and dimensions of the PCB could cause concentration of excessive stress on the wires, resulting in detachment or fracture, or package destruction. In this case carry out soldering after the device has been fixed in place.
- (5) Pay attention to the precautions described in 2.1 when conducting automatic insertion or forming.
- (6) After attachment of the diode to the PCB, if the PCB is to be cut or partitioned, bending of the board can concentrate excessive stress on the lead wires and/or package, resulting in damage to the package or disconnection of leads. In this case a process is needed that does not induce warping of board.

2.3 Soldering

2.3.1 The Insertion Type

When soldering the glass-sealed type diode, whether you use a soldering iron or the flow solder method, soldering should be done as quickly as possible and at the glass. With the DO-41 type, soldering work should be done within 5 seconds at 250°C and 10 seconds at 230°C at a point 4-6 mm away from the end of the glass body.

With the DHD type, soldering work should be done within 10 seconds at 260°C and 3 seconds at 350°C at a point 1-1.5 mm away from the end of the glass body.

Take the following precautions in soldering diodes:

- (1) Do not let the soldering iron touch the glass body directly (see figure 3A).
- (2) The soldering point should be over 3mm away from the diode body (see figure 3B).
- (3) Use of strongly alkaline or acidic flux can cause corrosion of the lead wires.
- (4) When solder or the soldering iron might touch the glass package of the diode during the soldering process, be sure to preheat the diode up to about 100°C.
- (5) Do not pull forcefully on the lead wires when inserting diodes into a printed circuit board (see figure 3C).
- (6) The recommended soldering iron is the type operated with a secondary voltage supply by transformer.
- (7) The soldering iron should also be grounded to prevent current leakage.
- (8) When using adhesives on circuit boards to fix diodes, the diode may break if the adhesive sets extremely hard.

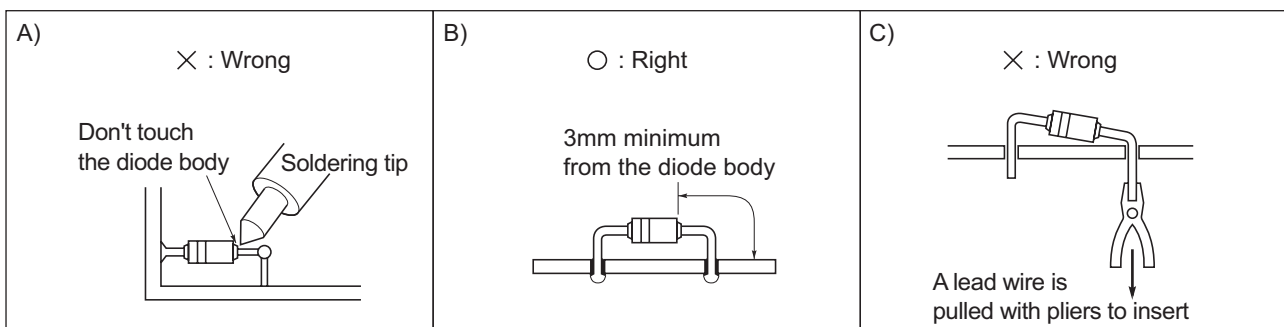

Figure 3 Precautions for Soldering

2.3.2 Surface Mounting Diode (SMD)

The recommended conditions for soldering SMD diodes are shown in table 2.

Table 2 SMD Soldering Mounting Inset Conditions

Package	Footprint (land) Dimensions	Cream Solder Thickness
MPAK-5		0.15 to 0.30mm
MPAK		0.15 to 0.30mm
CMPAK-4		0.15 to 0.30mm
CMPAK		0.15 to 0.30mm
VSON-5		0.15 to 0.30mm
MFP12		0.15 to 0.30mm
MP6		0.15 to 0.30mm
MP6-8		0.15 to 0.30mm
EFP		0.15 to 0.30mm

- Notes: 1. Footprint (land) dimensions are measured in millimeters.
 2. Cream solder thicknesses are the example values for reflow mounting.
 3. The temperature profile is shown below.

Table 2 SMD Soldering Mounting Inset Conditions (cont.)

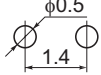
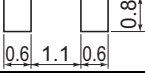
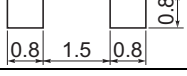
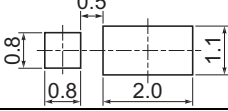
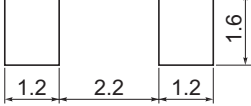
Package	Footprint (land) Dimensions	Cream Solder Thickness
SFP		0.15 to 0.30mm
UFP		0.15 to 0.30mm
URP		0.15 to 0.30mm
TURP		0.15 to 0.30mm
LLD		0.15 to 0.30mm

- Notes: 1. Footprint (land) dimensions are measured in millimeters.
 2. Cream solder thicknesses are the example values for reflow mounting.
 3. The temperature profile is shown below.

(1) Examples of Temperature Profile

a. Reflow-Soldering Conditions

Soldering Conditions for reflow soldering are shown below.

Table 3 Soldering Conditions for the Diode Packages

Lead plating	Sn-Pb		Sn-Bi, Sn-Cu	
Solder paste	Eutectic alloy of Sn-Pb	Sn-Ag	Eutectic alloy of Sn-Pb	Sn-Ag
Package surface temperature (upper limit)	Peak: 260°C 220°C or higher for no more than 60 s			
Temperature profile				

b. Flow-Soldering Conditions

Soldering Conditions for flow soldering are shown below.

Table 4 Soldering Conditions for Flow Soldering

Item	Condition	Upper Limit	Applicability
Preheating	Temperature	80 to 150°C	Substrate surface
	Time	1 to 3 minutes	
Solder dip	Temperature	230 to 250°C	Temperature of the solder layer
	Time	2 to 4 s	10 s

2.4 Cleaning

(1) Fading of the marking and color codes

Clearness of markings and color-fastness of color codes may be lost due to cleaning. Be sure to check these after using cleaning agents.

(2) Electrical and mechanical characteristics (discoloration, deformation, deterioration, etc.)

After cleaning a PCB, some corrosive material contained in the cleaning agent or flux may remain on semiconductor devices, causing corrosion of device wiring and leads with resulting loss of reliability.

Thorough cleaning is therefore required for PCBs. It is recommended that the level of purity of the PCB after cleaning should conform with the MIL standard below.

(3) There is a possibility that minute Leak is generated by the snuff of flux between leads in Narrow pitch and

Lower side electrode package. Please confirm the cleaning method of flux's not remaining.

Table 5 PCB Level of Purity After Cleaning

Item	Standard
Remaining Cl volume	$\leq 1 \mu\text{g}/\text{cm}^2$
Resistance of solvent (after extraction)	$\geq 2 \times 10^6 \Omega \cdot \text{cm}$

Notes: 1. PCB surface area: Both sides of the PCB + mounted components.

2. Extract solvent: Isopropyl alcohol: H₂O = 3 : 1

(Resistance of solvent before extraction is $\geq 6 \times 10^6 \Omega \cdot \text{cm}$)

3. Extraction method: Clean both sides of PCB with 10ml/2.54 × 2.54cm² (minimum of 1 minute)

4. Measuring extracted solvent resistance: Conductivity meter

See MIL-P-28809A for details of the MIL standard.

(4) Ultrasonic cleaning

It should be avoid to resonant to the devices. We recommend the following conditions.

- SMD

Frequency : 28 to 29 kHz (device should have no resonance)

Ultrasonic power output : 15 W/l (1 time)

Time : up to 30s

Others : Make sure that neither devices nor PCB come into contact with the vibration source.

2.5 Parts Layout

Environmental conditions have a decisive influence over the reliability of semiconductor devices. The layout of devices in a system should take into account temperature and heat radiation conditions as these are important for maintaining high reliability.

The examples of adverse layout given in the following.

(1) If a semiconductor device is located near a heat source such as a large resistor, the device's heat radiator will be exposed, and the temperature of the device will rise. If heating abnormally high, the device's reliability will suffer. Be sure to consider adequate ventilation when locating devices.

(2) Near high-voltage circuitry and in the corners at the bottom stage of equipment where dust easily gathers. In this type of area, dust and debris adhering to semiconductors can cause deterioration of the insulation, giving rise to faulty operation. As a precaution, semiconductors and PCBs installed in such locations should be coated with a waterproof resin.

Such waterproof coating for PCBs is extremely effective in assuring and improving reliability under adverse environmental conditions of use.

For example, where misoperation can occur due to shorts caused by electrically conductive debris (soldering or plating debris) lodged between circuit board wiring and semiconductor terminals; noise due to dust build-up and moisture absorption; faults due to large current leakage; steam, water drops and condensation due to sudden temperature fluctuation leading to metal migration (Ag migration); and deterioration hermetic seal of glass-sealed diodes (see figure 4).

In adverse environments where high humidity, condensation and dust build-up are prevalent, coating of PCBs is a crucial means of preserving reliability in systems that must assure reliable, maintenance-free service over a long period.

While there are a wide range of coating materials available, commonly used materials include the Tuffly®*¹ TR-1141, TF-1150, and TF1154 products and Humi-seal R1A27*².

Notes: 1. Manufactured by Hitachi Chemical Company, Ltd.

2. Manufactured by Boxy-Brown, Inc.

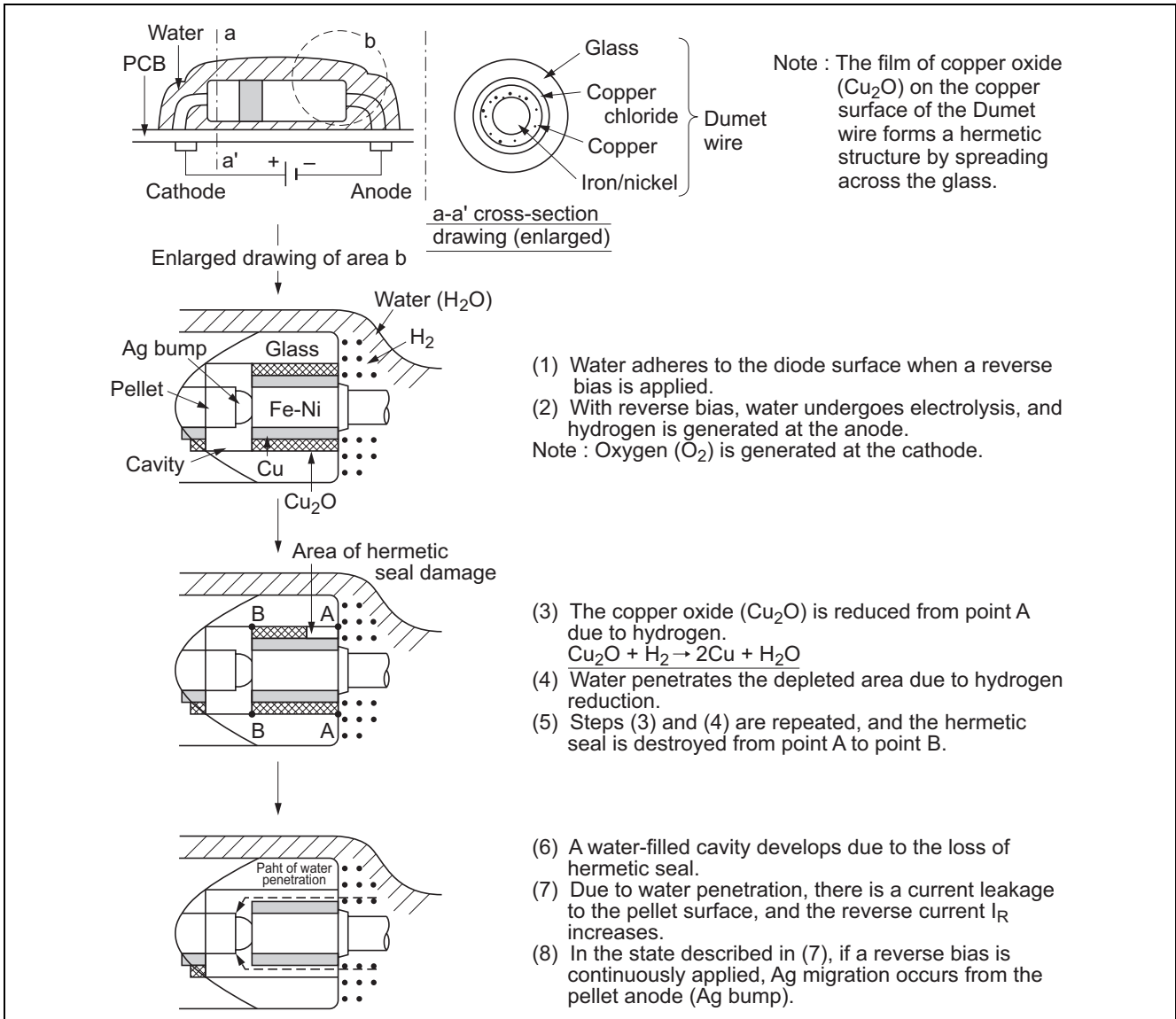

Figure 4 Hermetic Leakage Due to Electrolytic Corrosion

2.6 Diode Molds

- (1) When molding a diode in plastic, care should be used a buffer coating of resin or a low hardness mold material minimize stress on the diode.
- (2) If used a high hardness mold material, environmental changes or temperature changes could cause wire disconnection or destruction.

2.7 Surge Open Failure of DHD Type Diodes (including LLD)

If a surge voltage or current in excess of the ratings is applied to a DHD diode (including LLD), a short may develop, and in extreme cases, wire disconnection as shown in figure 5 might also occur.

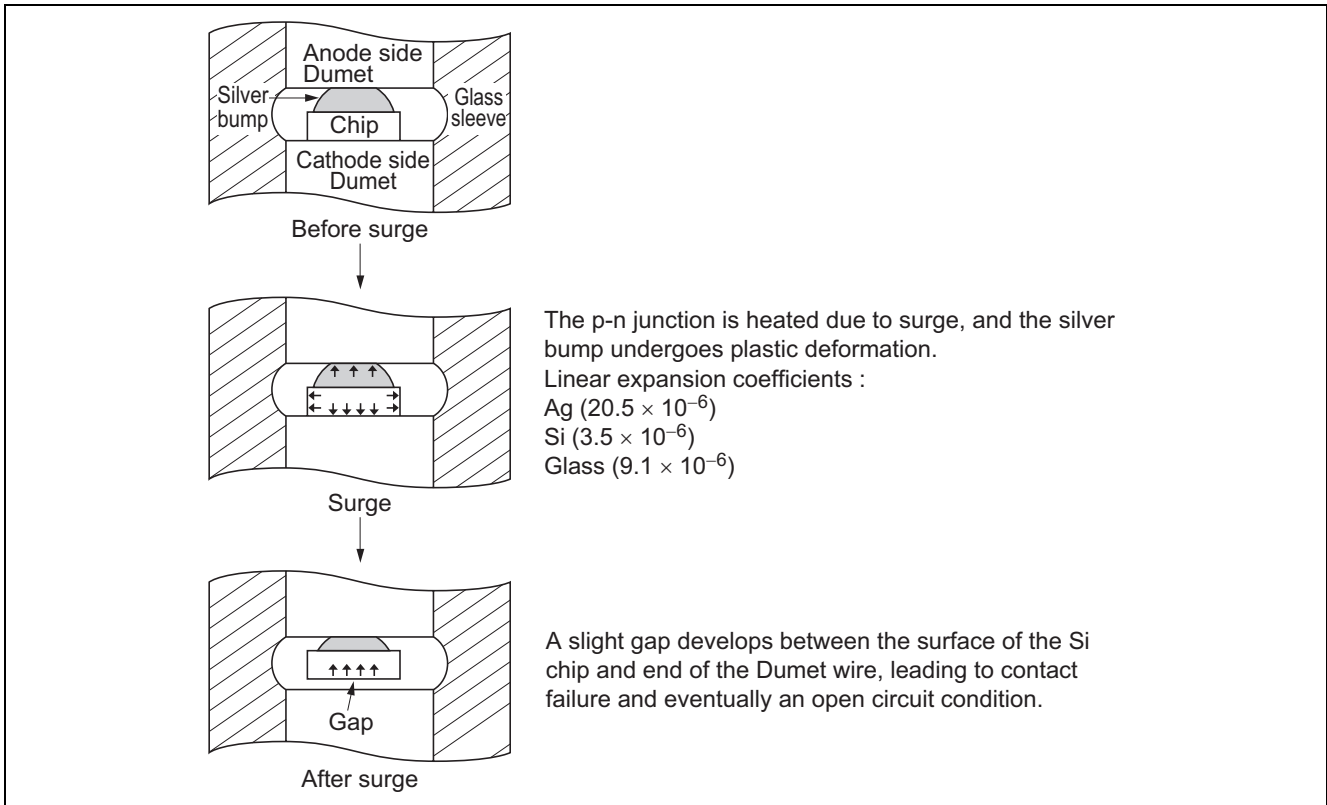

Figure 5 Plastic Deformation of Silver Bump Due to Heat During Surge Voltage/Current

3. Precautions for Circuit Mounting

Matching the circuit design and initial standards is a prerequisite for regards reliability design, while a margin must be allowed in consideration of deratings and fluctuations in characteristics. Reliability problems involve wiring, external surge, reactance load, noise margin, area of safe operation (ASO), reverse bias, flyback pulse, static electricity pulse stress and more.

3.1 General Precautions

Important factors in achieving the specified system reliability are using the devices within the parameter specifications shown in the catalog and observing the following points, taking account of the influence of peripheral components.

- (1) Keep the peripheral temperature as low as possible in order to avoid high temperatures in the vicinity of semiconductor elements.
- (2) Ensure that the power supply voltage, input voltage, power consumption, etc., are within specification, and use degrading.
- (3) Ensure that an excessive voltage is not applied to, or caused on, input, output, power supply, and other pins. Also ensure that these pins are not subjected to strong electromagnetic waves.
- (4) Ensure that static electricity is not generated during use.
- (5) When using high-speed elements, which have an extremely fine structure, either provide protection circuitry, etc., for the input section, or else ensure that electrostatic pulses are not applied.
- (6) When power is turned on and off, ensure that voltage application does not become unbalanced. For example, excessive stress will be exerted if a voltage is applied to input or power supply pins, etc., when circuit ground pins are floating.
- (7) In order to protect a circuit, please do not carry out use which destroys a diode electrically.
An example is shown in 3.2 about the main items.
- (8) Note on use in electromagnetic wave environments
A source of strong electromagnetic waves in the vicinity of a Zener diode may alter the characteristics of the diode. For example, a drop in the breakdown voltage has been reported when a portable wireless unit (144 MHz, 430 MHz) with a 3 W output is brought within a distance of 10 cm from a diode.
Please consult Renesas if there is a risk of exposure to strong electromagnetic waves in the operating environment.

3.2 Countermeasures to Noise and Surge Voltage

Surge voltage, static electricity, noise and other problems are common to all semiconductor devices, and require countermeasures to remove the causes or reduce their influence.

In designing semiconductor equipment, it is considered common practice to make an allowance of about 10% to cover fluctuations in commercial power supplies. However, failure or misoperation of semiconductor equipment could occur if mechanical equipment generating surge voltages is being used in the particular region. This is due to build-up of surge in the power line, and impulse surge can also be induced during electrical storms. Equipping the AC line with a filter like that shown in figure 6 can help reduce the effects of surge. Where surge and static electricity for the AC line does not enter indirectly, but could be applied directly to components and semiconductor devices on a circuit board, use of a shield or similar measure is required. Also, low ground impedance for a shield is essential. There is no effect if impedance is not low.

When direct static electricity or surge is likely to be input as noise, introduce a protector circuit like the one shown in figure 7 as a special countermeasure. The time constant $R_i \times C_i$ is set in such a way as to effectively absorb surge pulses without having influence on device operation.

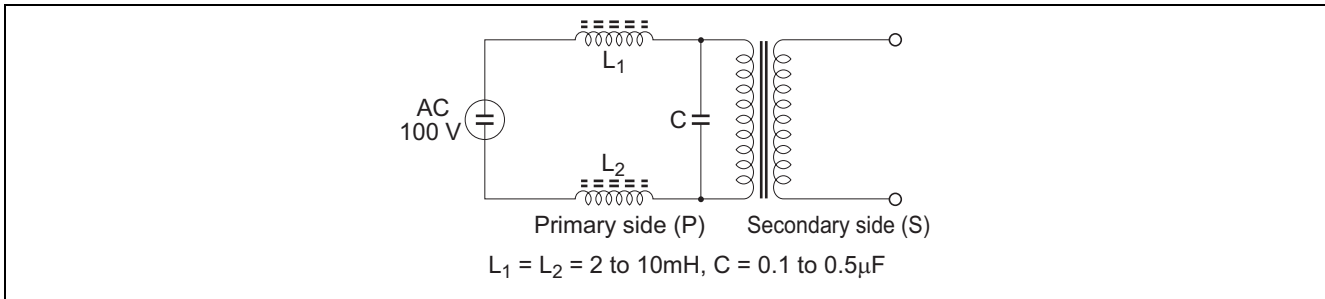

Figure 6 Example of Surge Absorption Circuit

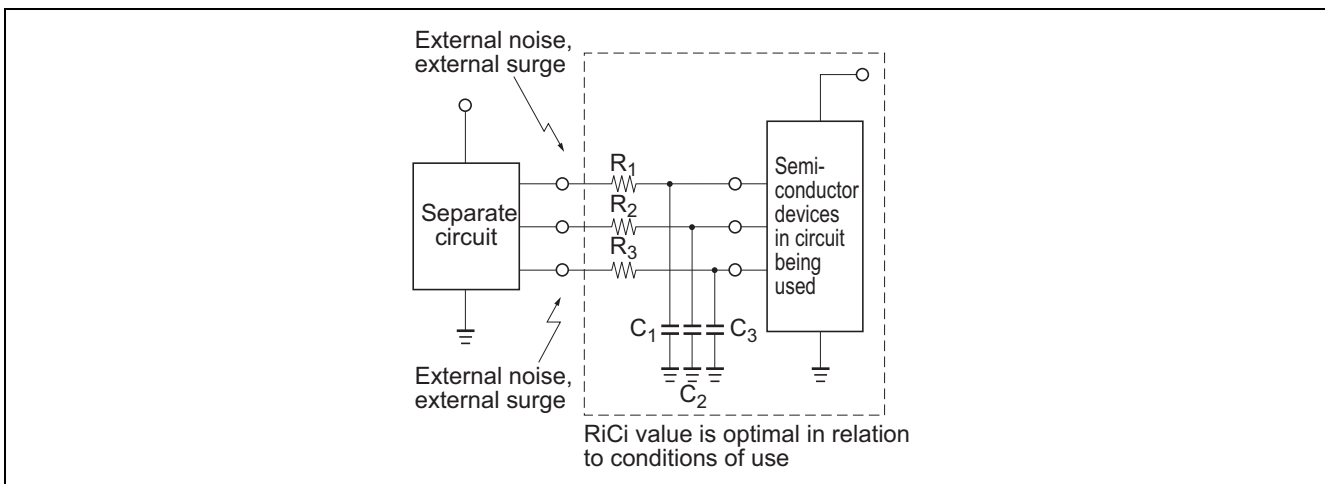

Figure 7 Example of Surge Protection Circuit

3.3 Characteristic Parameters and their Relation to Reliability

Each semiconductor device has its own characteristic parameters prescribed according to function and application. Each of these parameters has a predetermined range which should be matched. In system design, the significance of these parameters varies a great deal depending on application, and design must project a margin in initial characteristics as regards the critical parameters, or derating must be carried out. In the former case, a device should be selected with regard to the limit of operation range as a system. The statistical design method should be employed, and reliability testing as well as failure criteria of Renesas semiconductor devices should also be taken into consideration. In the case of derating, refer to the derating applications given under Renesas Semiconductor Device Reliability. Since the majority of parameter fluctuations cannot be foreseen under conditions of use, although design employing initial standards is considered justifiable in many cases, design with reference to failure criteria is needed as regards significant system items or items with no margin.

The following are points for consideration with regard to parameters.

- (1) Whether the significance of a parameter extends to system failure.
- (2) The state of the parameter's initial value margin.
- (3) Does the parameter change over time, and if so, is the change in the direction of the margin?
- (4) Is the change permissible for use of the device with other devices?
- (5) Is redundant design possible?
- (6) Is it possible to introduce the statistical design method for parameters?

4. Precautions for Storage, Transportation and Measuring

Other precautions involve problems occurring during storage, transportation and measurement.

Although the general precautions for storage and transportation of electronic components can be applied as they are to semiconductor devices, the latter require certain special precautions in addition to these. The following account includes the general precautions.

4.1 Storage of Semiconductor Devices

The following methods of storage are advisable for semiconductor devices. If the precautions are not observed, faults in electrical characteristics, solderability, external appearance and other attributes may occur. In some cases, failure may also result.

Precautions for storage are as follows:

- (1) The storage location should be kept within the optimum ranges of temperature and humidity: 5 to 35°C and 45 to 75% R.H. are the optimal conditions.
- (2) The atmosphere in the storage location should not contain any noxious gases, and the amount of dust should be minimal.
- (3) Storage containers should not be susceptible to static electricity.
- (4) Semiconductor devices should not be subjected to loads.
- (5) When storing for long periods, store in the non-processed state. When leads have already been formed, corrosion at their bent portion of leads may occur.
- (6) Be sure that sudden temperature changes sufficient to cause condensation do not occur during storage of the devices.

4.2 Precautions for Transportation

When transporting semiconductor devices or their assembly units or subsystems, the same precautions as for other electronic components should be taken. The items listed in 4.1 and 4.2 have to be followed.

- (1) Transportation containers, jigs etc., should not pick up static charge due to vibration en route.
- (2) When transporting semiconductor devices and PCBs, try to keep mechanical vibration and shocks to an absolute minimum.

Especially when bag packing of a glass-sealed type diode is dealt with, be careful of the following point.

Even when the following handling is performed and there is no externally caused injury remarkable in a bag or a packing box, the products in a bag may collide and a glass chip and a crack may arise.

- a. Please do not perform what a floor etc. is dropped or throws the packing box containing the product to it.
- b. When a packing box conveys a product, please use shock absorbing material for neither vibration of transportation nor a shake to join a direct product.

4.3 Precautions for Measuring

(1) Persons handling semiconductor devices should be grounded via a high resistance to discharge any static electricity that may be adhering to their clothing. The resistance value should be around 1 MΩ and no other person should come between the person being discharged and ground (GND). See figure 8 for static electricity data for human bodies. Since the product shown in Table 6 is susceptible to destruction by static charge. Be specially aware, therefore, of electrical charge on persons and on equipment in the vicinity.

Table 6 Static Electricity Destruction Voltage

Part No.	Static Electricity Destruction Voltage
HSB88YP, HSC276, HSM88AS, HSM88ASR, HSM88WA, HSM88WK, HSM198S, HSM276S, HSM276SR, HSU88, HSU276	30 V
HVU359, HVU17, HVC365	80 V
HSM107S	100 V

Note: 1. Test condition: C = 200 pF, Both forward and reverse direction 1 pulse.

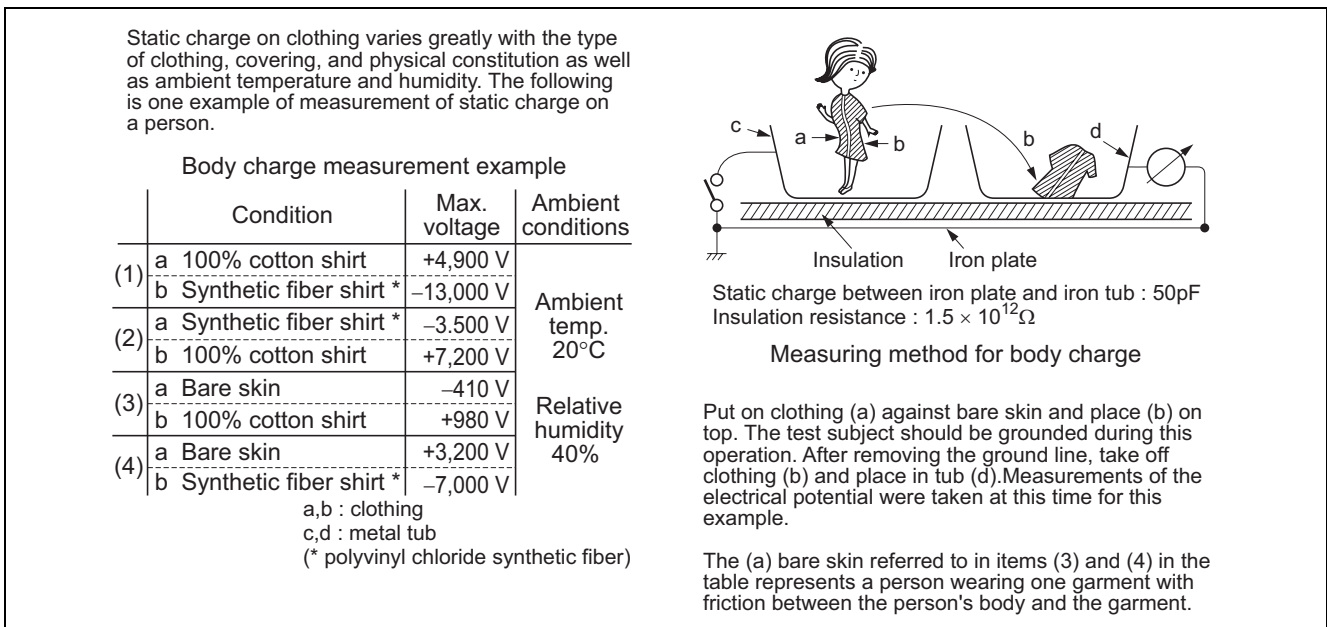

Figure 8 Example of Measuring Static Charge on a Person

5. Precautions for Use of each Line of Products

5.1 Precautions for use of DHD Type Diodes

- (1) Since the glass-sealed (DHD) type diode body consists of glass and lead wire solder, consider the following to prevent subjecting these diodes to unreasonable force.
 - a. Do not drop glass-sealed (DHD) type diodes on concrete, glass plate, metal plate or any other hard surface to avoid undue mechanical shock. Such shocks could result in cracking of the glass body, deterioration of characteristics, destruction or loss of hermetic seal.
 - b. When forming and cutting, excessive force should not be applied to the body of the glass-sealed type diode. The tension from leads to body must be kept below 10 N in such processing.
It is needed to secure lead wires with approximately 30 N, or otherwise to shift the cutter blade timing of both sides.
- (2) Schottky barrier diodes are susceptible to destruction by static charge. Be specially aware, therefore, of electrical charge on persons and on equipment in the vicinity.
- (3) The main market failure modes of a diode are based on surge. Please take into consideration enough on surge and derating conditions.

5.2 Precautions for use of SMD Diodes

- (1) SMD diodes are formed in consideration of PCB mountability, and can be mounted without modification. UFP, SFP, EFP, MP6 Series TURP, VSON-5, and MFP12 types are extremely small, special packages that are very susceptible to tensile force on leads. It is not used that they be mounted or later adjusted by hand.
- (2) When mounting on a PCB, adhesive is used to temporarily hold diodes in place before solder is applied. When a SMD diode is held by adhesive, be sure that it is not subjected to undue stress.
- (3) Since SMD diodes come in small package, be aware of thermal stress from soldering, flux and cleaning. Soldering should be done in as short a time as possible.
 - When flow soldering: 260°C max for 10 s.
 - When using a soldering iron: 350°C max for 3 s.
 Organic flux (rosin) is frequently used for soldering, and in view of corrosion resistance and insulation, this material is also recommended for soldering SMD.
After soldering a SMD, wash thoroughly or use the shower method or ultrasonic method for cleaning off the flux. (Refer 2.3.2 for the recommended conditions.)
- (4) Compared with other diffuse junction diodes, the SMD Schottky barrier diode is exceptionally prone to damage by static electricity, so it is needed to protect these diodes.
- (5) When targeted for use under severe environmental conditions, SMD diodes should receive a moisture-proof coating after assembly on a PCB. It is advisable to coat the circuit board to protect it against external debris and moisture [see 2.5 (2)].
- (6) Using a mounter to fix SMD diodes to a PCB can result in bending of the leads, so make sure that a force of no more than 3 N is applied. And also required to not apply superfluous force on the package or leads as being mounted, especially for UFP, SFP, EFP, TURP, VSON-5T, MFP12, MP6 Series package and the package with halogen free resin.

- (7) When the SMD is mounted through reflow soldering, avoid incorrect positioning and floating-type failures due to bad mounting balance by taking care on the following points.
- The left and right land patterns must have the same shape.
 - The left and right land areas, including the wiring sections, must take up the same area and include the same amount of solder.
 - The land position should become symmetrical.
 - Heat must be applied to both soldering sections at the same time (the direction shown in figure 9 is recommended).

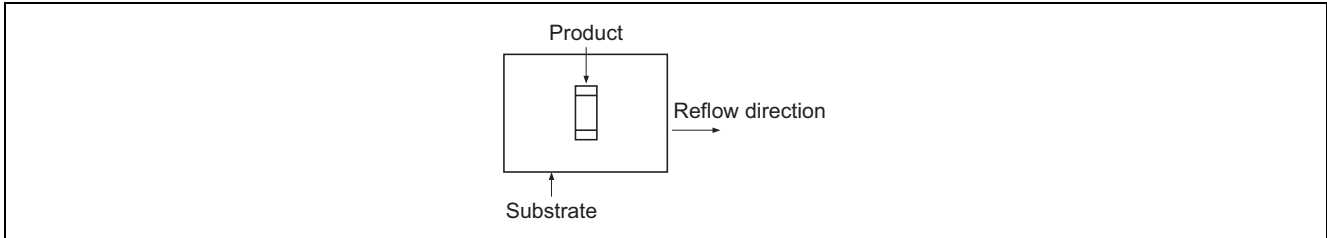

Figure 9

- (8) Do not apply high temperatures in soldering some of the packages, e.g. by using a soldering iron, since this applies strong thermal stress to the packages. (Please refer to the data sheet.)
- (9) The lead material is exposed at the end of the leads of the package, because this is a cut surface. Accordingly, the solderability of the ends of the leads has not been checked. Users of this package must check this themselves.

5.3 Precautions for use of LLD Diodes

- (1) When mounting LLD diodes to a circuit board, and using adhesive to temporarily fix them in position (particular when a large volume is used), soldering and consequent heating can subject diodes to excessive stress, which could result in cracking of their glass packages. Mount LLD diodes with low hardness and small bond in temporary.
- (2) Use rosin type flux to assure reliable mounting. Use of chlorine containing flux can lower reliability by causing corrosion of Dumet wire.
- (3) Make sure that diodes are not subjected to excessive stress during or after mounting on a PCB.
- a. Horizontal direction : 10 N or less
 - b. Axial direction : 5 N or less (compression and tensile forces)
 - c. Board warp : Warp width 2 mm or less (when support gap is 90 mm)

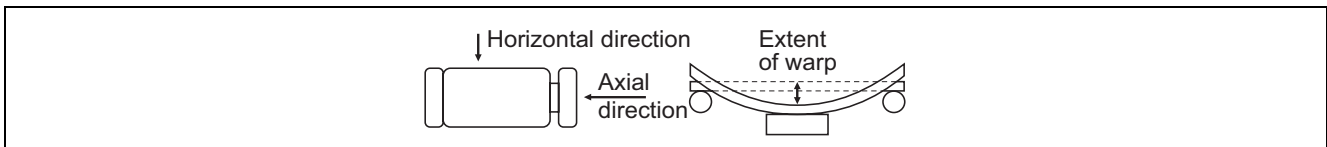

Figure 10

- (4) Refer to the 5.2(7) for the notes at the time of carrying out reflow mounting of the LLD.

5.4 Precautions for use of LLD, UFP, SFP, EFP, MP6 Series, TURP, VSON-5, and MFP12 Diodes

- (1) When mounting diodes to a circuit board, so make sure that flatten on the PCB.
(Not becoming rough by wiring under diode body.)
- (2) Please superfluous power does not join a product by the curvature of a circuit board or bending by circuit board break etc.

5.5 Note on Product Safety

5.5.1 Renesas Efforts in the Product Safety Area

While Japan's product liability (PL) law came into effect in July 1995, Renesas has always considered product safety to be one aspect of quality, and has always stressed product safety in semiconductor products as an integral part of our product quality program. The following describes Renesas's basic approach to product safety and specific activities related to product safety.

Note that the product safety promised by Renesas consists of items generally required of semiconductor products themselves, which are then used as components in user systems. Safety measure required by the customer's product application and/or usage environment must be taken by the customer.

(1) Product safety measures from the product fabrication stage

Renesas incorporates items related to product safety into each of the processes, such as the "sample reliability program" and the "quality approval flow" shown in the quality assurance system. Thus product safety is incorporated as an aspect of quality control from the product specification determination, development, and design stages.

Table 7 lists the main product safety items in the major steps from product development through shipment and sales.

Table 7 Main Product Safety Items

Main Division	Items that must be considered (main points)
<ul style="list-style-type: none"> • Product development • Specification determination 	<ul style="list-style-type: none"> • Customer applications • Usage environment
<ul style="list-style-type: none"> • Design 	<ul style="list-style-type: none"> • Catastrophic failure modes • Malfunction modes
<ul style="list-style-type: none"> • Manufacture 	<ul style="list-style-type: none"> • Making manufacturing rules explicit and strictly following said rules.
<ul style="list-style-type: none"> • Quality assurance • Sales 	<ul style="list-style-type: none"> • Quality assurance and evaluation/verification at each stage in the manufacturing process • Provision of a complete documentation set

(2) Documentation

Renesas provides a full complement of documentation, including data sheets, that present the performance of our products so that these semiconductor products can be used safely. Renesas also issues a wide range of documents written from the standpoint of product safety so that our customers can obtain the full specified performance of our products in their applications.

Table 8 Documents Related to Product Safety

Application area	Specific document examples
Documents that present product specifications	Data sheets, technology reports, and delivery specifications documents (purchase specifications documents)
Documents that present usage notes	Reliability handbooks and packaging manuals
Other documents (Documents produced under individual agreements with customers)	Sales contracts and quality agreements

(3) Safety measures based on meetings with customers to discuss specifications and product quality

Renesas is prepared to hold product quality meetings with customers to assure that our customers are able to use our products under conditions appropriate to the specifications of the product. As mentioned previously, these conditions are announced in a variety of documents. However, we are more than willing to meet with customers to discuss product selections appropriate to the customer's applications.

5.6 Requests to Our Customers

To use Renesas semiconductor products safely, carefully consider the following points when designing equipment and systems.

- (1) When using Renesas semiconductor products, read all the documentation provided carefully, and verify the specifications of the product itself as they relate to the environment under which the product will be used and operated. If you find any points in any Renesas document unclear, please report that to your Renesas sales representative.
- (2) If Renesas products are to be used in areas that require high reliability and high safety margins (such as trunk line communication systems, transportation system equipment, aircraft or aerospace applications, or safety equipment), be sure to take the characteristics and reliability of the semiconductor devices themselves into consideration at the unit or system design stage, and adopt appropriate failsafe design techniques in the system design.
- (3) Renesas does not provide semiconductor products that were developed with special consideration for use in equipment that human life may be dependent on. If you are considering using Renesas products in life support or other medical equipment, please contact your Renesas sales representative and inform us as to whether or not you have adopted safety measures in the system design.
- (4) Renesas is prepared to meet with customers if necessary to discuss measures such as product selection to allow semiconductor products to be used without problem. If you have any questions, doubts, or concerns about product safety, please feel free to discuss those with your Renesas sales representative.

Website and Support

Renesas Technology Website
<http://www.renesas.com/>

Inquiries
<http://www.renesas.com/inquiry>
csc@renesas.com

Revision Record

Rev.	Date	Description	
		Page	Summary
1.00	Jul.28.04	—	First edition issued
2.00	Sep.05.06	5, 6, 15	Updates to latest information
3.00	Sep.26.07	5, 6, 14 to 17, 20	Updates to latest information
4.00	Jan.30.09	5, 7, 14 to 16	Updates to latest information

All trademarks and registered trademarks are the property of their respective owners.

Notes regarding these materials

1. This document is provided for reference purposes only so that Renesas customers may select the appropriate Renesas products for their use. Renesas neither makes warranties or representations with respect to the accuracy or completeness of the information contained in this document nor grants any license to any intellectual property rights or any other rights of Renesas or any third party with respect to the information in this document.
2. Renesas shall have no liability for damages or infringement of any intellectual property or other rights arising out of the use of any information in this document, including, but not limited to, product data, diagrams, charts, programs, algorithms, and application circuit examples.
3. You should not use the products or the technology described in this document for the purpose of military applications such as the development of weapons of mass destruction or for the purpose of any other military use. When exporting the products or technology described herein, you should follow the applicable export control laws and regulations, and procedures required by such laws and regulations.
4. All information included in this document such as product data, diagrams, charts, programs, algorithms, and application circuit examples, is current as of the date this document is issued. Such information, however, is subject to change without any prior notice. Before purchasing or using any Renesas products listed in this document, please confirm the latest product information with a Renesas sales office. Also, please pay regular and careful attention to additional and different information to be disclosed by Renesas such as that disclosed through our website. (<http://www.renesas.com>)
5. Renesas has used reasonable care in compiling the information included in this document, but Renesas assumes no liability whatsoever for any damages incurred as a result of errors or omissions in the information included in this document.
6. When using or otherwise relying on the information in this document, you should evaluate the information in light of the total system before deciding about the applicability of such information to the intended application. Renesas makes no representations, warranties or guaranties regarding the suitability of its products for any particular application and specifically disclaims any liability arising out of the application and use of the information in this document or Renesas products.
7. With the exception of products specified by Renesas as suitable for automobile applications, Renesas products are not designed, manufactured or tested for applications or otherwise in systems the failure or malfunction of which may cause a direct threat to human life or create a risk of human injury or which require especially high quality and reliability such as safety systems, or equipment or systems for transportation and traffic, healthcare, combustion control, aerospace and aeronautics, nuclear power, or undersea communication transmission. If you are considering the use of our products for such purposes, please contact a Renesas sales office beforehand. Renesas shall have no liability for damages arising out of the uses set forth above.
8. Notwithstanding the preceding paragraph, you should not use Renesas products for the purposes listed below:
 - (1) artificial life support devices or systems
 - (2) surgical implantations
 - (3) healthcare intervention (e.g., excision, administration of medication, etc.)
 - (4) any other purposes that pose a direct threat to human life

Renesas shall have no liability for damages arising out of the uses set forth in the above and purchasers who elect to use Renesas products in any of the foregoing applications shall indemnify and hold harmless Renesas Technology Corp., its affiliated companies and their officers, directors, and employees against any and all damages arising out of such applications.
9. You should use the products described herein within the range specified by Renesas, especially with respect to the maximum rating, operating supply voltage range, movement power voltage range, heat radiation characteristics, installation and other product characteristics. Renesas shall have no liability for malfunctions or damages arising out of the use of Renesas products beyond such specified ranges.
10. Although Renesas endeavors to improve the quality and reliability of its products, IC products have specific characteristics such as the occurrence of failure at a certain rate and malfunctions under certain use conditions. Please be sure to implement safety measures to guard against the possibility of physical injury, and injury or damage caused by fire in the event of the failure of a Renesas product, such as safety design for hardware and software including but not limited to redundancy, fire control and malfunction prevention, appropriate treatment for aging degradation or any other applicable measures. Among others, since the evaluation of microcomputer software alone is very difficult, please evaluate the safety of the final products or system manufactured by you.
11. In case Renesas products listed in this document are detached from the products to which the Renesas products are attached or affixed, the risk of accident such as swallowing by infants and small children is very high. You should implement safety measures so that Renesas products may not be easily detached from your products. Renesas shall have no liability for damages arising out of such detachment.
12. This document may not be reproduced or duplicated, in any form, in whole or in part, without prior written approval from Renesas.
13. Please contact a Renesas sales office if you have any questions regarding the information contained in this document, Renesas semiconductor products, or if you have any other inquiries.