

**RTK0EM0000B10020BJ**

**Schematic**

- 01 : Contents
- 02 : Inverter
- 03 : Connector
- 04 : History

Supplementary explanation :

DNF: unmounted part

Access point : <horizontal, vertical, page>

Ex.

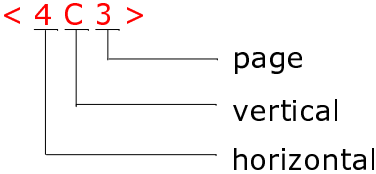

Title		
RTK0EM0000B10020BJ		
Size	Document Number	Rev
A3	R12TU0072EJ0120	1.20
Date:	Monday, February 28, 2022	Sheet 1 of 4

Inverter circuit

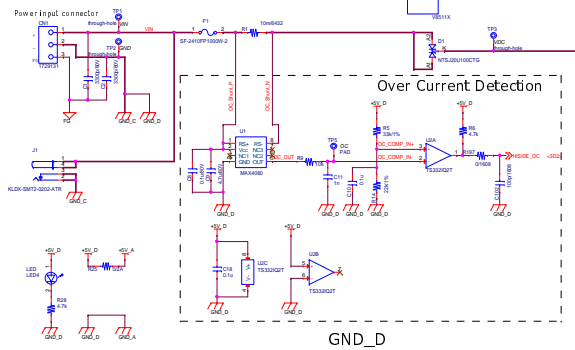

GND\_D

DC/DC 12V

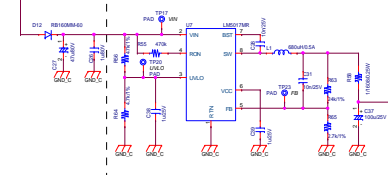

GND\_C

Linear Regulator 5V

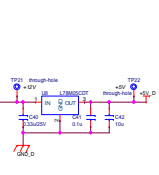

GND\_D

3.3V LDO

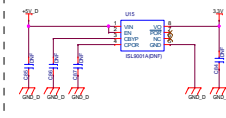

GND\_D

Gate Driver Full Bridge

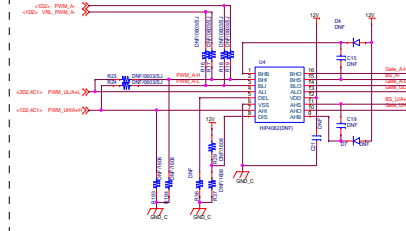

Gate Driver 3 Phase

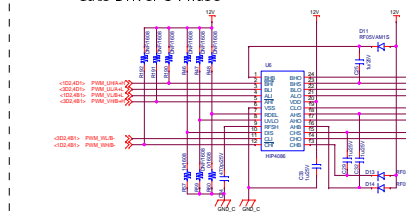

Gate Driver Full Bridge

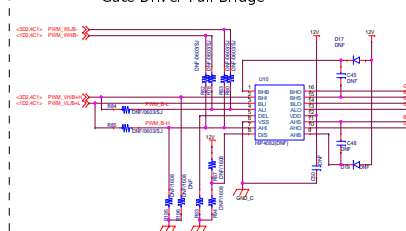

GND\_C

B+/V

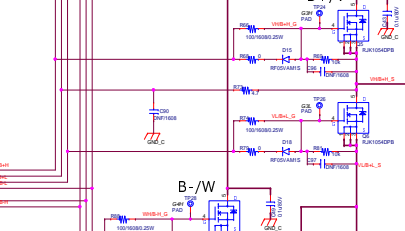

B-/W

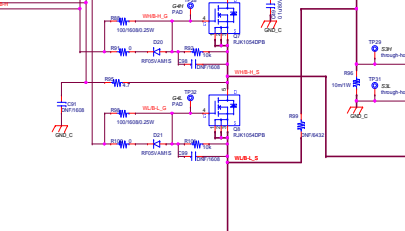

GND\_A



### History

Rev.	Date	Page	Summary
1.00	2020/3/12	—	First edition
1.10	2020/9/25	P2 P3	R53, R62, R90, R97, R109, R111 : 100 -> 22 C35, C36, C52, C53, C57, C58 : 1n -> 0.1u R116 : 0 -> DNF R124 : 0 -> DNF Add R198, R199, R200, C105, C106, C107 For Lot No. 21xxxxx or later
1.11	2021/5/14	P2 P3	R53, R62, R90, R97, R109, R111 : 22 -> 0 C35, C36, C52, C53, C57, C58 : 0.1n -> DNF R198, R199, R200 : 680 -> 100 C105, C106, C107 : 3.3n -> 1n
1.20	2021/8/23	P2	R190, R191, R192 : 100k -> DNF For Lot No. 22xxxxx or later