

Semiconductor Package Mount Manual

Notice

1. Descriptions of circuits, software and other related information in this document are provided only to illustrate the operation of semiconductor products and application examples. You are fully responsible for the incorporation or any other use of the circuits, software, and information in the design of your product or system. Renesas Electronics disclaims any and all liability for any losses and damages incurred by you or third parties arising from the use of these circuits, software, or information.
2. Renesas Electronics hereby expressly disclaims any warranties against and liability for infringement or any other claims involving patents, copyrights, or other intellectual property rights of third parties, by or arising from the use of Renesas Electronics products or technical information described in this document, including but not limited to, the product data, drawings, charts, programs, algorithms, and application examples.
3. No license, express, implied or otherwise, is granted hereby under any patents, copyrights or other intellectual property rights of Renesas Electronics or others.
4. You shall not alter, modify, copy, or reverse engineer any Renesas Electronics product, whether in whole or in part. Renesas Electronics disclaims any and all liability for any losses or damages incurred by you or third parties arising from such alteration, modification, copying or reverse engineering.
5. Renesas Electronics products are classified according to the following two quality grades: "Standard" and "High Quality". The intended applications for each Renesas Electronics product depends on the product's quality grade, as indicated below.
"Standard": Computers; office equipment; communications equipment; test and measurement equipment; audio and visual equipment; home electronic appliances; machine tools; personal electronic equipment; industrial robots; etc.
"High Quality": Transportation equipment (automobiles, trains, ships, etc.); traffic control (traffic lights); large-scale communication equipment; key financial terminal systems; safety control equipment; etc.
Unless expressly designated as a high reliability product or a product for harsh environments in a Renesas Electronics data sheet or other Renesas Electronics document, Renesas Electronics products are not intended or authorized for use in products or systems that may pose a direct threat to human life or bodily injury (artificial life support devices or systems; surgical implantations; etc.), or may cause serious property damage (space system; undersea repeaters; nuclear power control systems; aircraft control systems; key plant systems; military equipment; etc.). Renesas Electronics disclaims any and all liability for any damages or losses incurred by you or any third parties arising from the use of any Renesas Electronics product that is inconsistent with any Renesas Electronics data sheet, user's manual or other Renesas Electronics document.
6. When using Renesas Electronics products, refer to the latest product information (data sheets, user's manuals, application notes, "General Notes for Handling and Using Semiconductor Devices" in the reliability handbook, etc.), and ensure that usage conditions are within the ranges specified by Renesas Electronics with respect to maximum ratings, operating power supply voltage range, heat dissipation characteristics, installation, etc. Renesas Electronics disclaims any and all liability for any malfunctions, failure or accident arising out of the use of Renesas Electronics products outside of such specified ranges.
7. Although Renesas Electronics endeavors to improve the quality and reliability of Renesas Electronics products, semiconductor products have specific characteristics, such as the occurrence of failure at a certain rate and malfunctions under certain use conditions. Unless designated as a high reliability product or a product for harsh environments in a Renesas Electronics data sheet or other Renesas Electronics document, Renesas Electronics products are not subject to radiation resistance design. You are responsible for implementing safety measures to guard against the possibility of bodily injury, injury or damage caused by fire, and/or danger to the public in the event of a failure or malfunction of Renesas Electronics products, such as safety design for hardware and software, including but not limited to redundancy, fire control and malfunction prevention, appropriate treatment for aging degradation or any other appropriate measures. Because the evaluation of microcomputer software alone is very difficult and impractical, you are responsible for evaluating the safety of the final products or systems manufactured by you.
8. Please contact a Renesas Electronics sales office for details as to environmental matters such as the environmental compatibility of each Renesas Electronics product. You are responsible for carefully and sufficiently investigating applicable laws and regulations that regulate the inclusion or use of controlled substances, including without limitation, the EU RoHS Directive, and using Renesas Electronics products in compliance with all these applicable laws and regulations. Renesas Electronics disclaims any and all liability for damages or losses occurring as a result of your noncompliance with applicable laws and regulations.
9. Renesas Electronics products and technologies shall not be used for or incorporated into any products or systems whose manufacture, use, or sale is prohibited under any applicable domestic or foreign laws or regulations. You shall comply with any applicable export control laws and regulations promulgated and administered by the governments of any countries asserting jurisdiction over the parties or transactions.
10. It is the responsibility of the buyer or distributor of Renesas Electronics products, or any other party who distributes, disposes of, or otherwise sells or transfers the product to a third party, to notify such third party in advance of the contents and conditions set forth in this document.
11. This document shall not be reprinted, reproduced or duplicated in any form, in whole or in part, without prior written consent of Renesas Electronics.
12. Please contact a Renesas Electronics sales office if you have any questions regarding the information contained in this document or Renesas Electronics products.

(Note 1) "Renesas Electronics" as used in this document means Renesas Electronics Corporation and also includes its directly or indirectly controlled subsidiaries.

(Note 2) "Renesas Electronics product(s)" means any product developed or manufactured by or for Renesas Electronics.

Table of Contents

1. Overview of Soldering Technology.....	1
1.1 Soldering Methods.....	2
1.1.1 Types of Soldering Method.....	2
1.1.2 Features of the Different Soldering Methods.....	3
1.1.3 Partial Heat Methods.....	4
1.1.4 Total Heating Methods.....	6
1.1.5 Adaptation by Package Types.....	11
1.1.6 Solder Mounting Processes.....	12
1.1.7 Basic Mounting Processes.....	12
1.1.8 Single-sided Soldering.....	13
1.1.9 Double-sided Soldering.....	17
2. Printed Wiring Board Design.....	25
2.1 Lead-Type SMDs.....	25
2.1.1 Pin Location Range for Lead-Type SMDs.....	26
2.1.2 Dimensional Examples for Different Package Types.....	27
2.2 Ball-Type SMD (Including LGA) Packages.....	36
2.2.1 Pin Positions (Areas) for Ball-Type SMD Packages.....	36
2.2.2 Mounting Pad Design for BGA and LGA Packages.....	37
2.2.3 Mounting Pad Dimensions (Design Range).....	37
2.3 THDs.....	38
2.3.1 THD Pin Location Range.....	38
2.3.2 Through Hole Diameter Design.....	40
2.3.3 Through Hole Diameter Dimensional Design for Printed Wiring Boards (Design Ranges).....	40
2.4 Discrete Devices.....	41
2.5 Board Materials.....	41
2.5.1 Preventing Mounting Pad Oxidation.....	42
2.5.2 Printed Wiring Board Warping.....	43
2.5.3 Solder Joint Reliability.....	43
3. Mounting Processes.....	45
3.1 Solder Supply Processes.....	45
3.1.1 Solder Paste.....	45
3.1.2 Solder Paste Printing Processes.....	48
3.1.3 Amount of Solder Paste Supplied.....	50
3.2 Component Mounting Processes.....	55
3.2.1 Adhesives.....	55
3.2.2 Component Placement Equipment.....	55
3.2.3 Self-Alignment Effect.....	56
3.3 Soldering Processes.....	64
3.3.1 The Temperature Profile Concept.....	64
3.3.2 Temperature Profile Conditions.....	65
3.3.3 Notes on BGA Package Reflow Soldering.....	67
3.3.4 Temperature Distributions in Mixed Mounting.....	68
3.4 Cleaning Process.....	70
3.4.1 Flux Selection.....	71
3.4.2 Cleaning Fluid Selection.....	71
3.4.3 Selecting the Cleaning Method and Equipment.....	72
3.4.4 Assessment Methods.....	73
3.5 Inspection Process.....	74
3.5.1 Visual Inspection Equipment.....	75

3.5.2	Visual Inspection Items	76
3.6	Repairing and Reworking	78
3.6.1	Repairing	78
3.6.2	Reworking	79
4.	Notes on Storage and Mounting	85
4.1	Solderability	85
4.1.1	Plating Composition	85
4.1.2	Solderability Evaluation Method	86
4.1.3	Plating Thickness	87
4.1.4	Wetting Time Temperature Dependence	88
4.1.5	Solderability following High-Temperature Storage	89
4.1.6	Solderability following Long-Term Storage	90
4.2	Package Storage Conditions	92
4.2.1	Storage Before Opening Moisture-Proof Packing	92
4.2.2	Storage After Opening Moisture-Proof Packing	92
4.2.3	Baking	93
4.2.4	Reflow Cycles	93
4.3	Soldering Temperature Profiles	94
4.3.1	Heat Resistance Profiles	94
4.3.2	Heat Resistance Temperature Profile Symbols	95
4.3.3	Soldering Temperature	102
4.3.4	Package Contact and Pin Plating Metal Compositions	103
4.3.5	Notes on Solder Shorts and Opens	103
4.4	Temperature Conditions on Second Reflow	104
4.5	Mechanical Strength of Soldered Sections After Mounting	104
5.	Examples of Mounting and Problems	105
5.1	BGA Mounting Process	105
5.1.1	Notes on Lead-Free Solder Mounting	105
5.1.2	Notes on WLBGA Usage	106
5.1.3	Mounting Example (WLBGA)	106
5.1.4	Examples of Problems in BGA Mounting	109
5.2	LGA Mounting Process	119
5.2.1	Mounting Case (FLGA)	119
5.2.2	LGA Problem Cases	122
5.3	Notes on Mounting Pad Design for HQFP and HLQFP Mounting	124
5.3.1	Mounting Pad Design Example for HLQFP Mounting	124
5.4	Lead-Free Solder Mounting Examples	125
5.4.1	External Appearance of Pins Plated with Lead-Free Solder (Lead-Type)	125
5.4.2	Cross Sectional Photographs after Mounting of Pins Plated with Lead-Free Solder (Lead-Type)	126
5.5	Mounting Example: 0.4 mm Pitch LQFP	127
5.5.1	Comparison of 0.5 and 0.4 Pitch LQFP Packages	127
5.5.2	Pin Strength Test Example	127
5.5.3	Mounting Pad Design	128
5.5.4	Solder Paste	128
5.5.5	Mounting Example 1 — Solder Paste Squeezing When Mounting — (Reference Data)	128
5.5.6	Mounting Example 2 — Post Solder Mounting Testing — (Reference Data)	129
5.6	Mounting Example for Package with Header (Heat Spreader)	130
5.6.1	Mounting Example	130
5.6.2	Improvement Example	130
5.7	Notes on HSON Mounting Pad Design	133
5.7.1	Printed Wiring Board Mounting Example for an 8-Pin HSON Package	133

6. Solder Joint Reliability	135
6.1 Influence of Reflow Soldering Temperature.....	135
6.1.1 Ball-type SMD	135
6.1.2 Lead-type SMD.....	136
6.2 Influence of Printed Wiring Board Thickness.....	137
6.3 Influence of Printed Wiring Board Materials (1).....	137
6.4 Influence of Printed Wiring Board Materials (2).....	138
6.5 Influence of Printed Wiring Board Pad Structure	138
6.6 Single-Sided and Double-Sided Mounting	139
6.7 Combinations of Package Lead Pin Plating and Solder Materials	140
6.8 Combinations of Package Ball Pin and Solder Materials.....	141
6.9 Mechanical Strength	142
6.9.1 QFP Lead Connection Strength.....	142
6.9.2 BGA Ball Attachment Strength after High-Temperature Storage.....	144
6.9.3 Measures to Improve Resistance to Mechanical Shock	144
6.10 Migration	146
7. Appendix.....	147
7.1 Characteristics of Constituent Materials	147
7.1.1 Thermal Expansion Coefficients of Constituent Materials	147

1. Overview of Soldering Technology

The electronics industry is seeing ever strong demands for increasing functionality and smaller and thinner form factors in end products. At the same time, there are continuing demands for lower costs, and these demands are only expected to get stronger with time.

The technologies used for mounting devices (packages) are critical for responding to these demands and a wide range of techniques and processes have been studied and applied.

As an example, figure 1.1 shows the technologies required in typical solder mounting. This chapter presents an overview of solder mounting methods (and equipment) and processes.

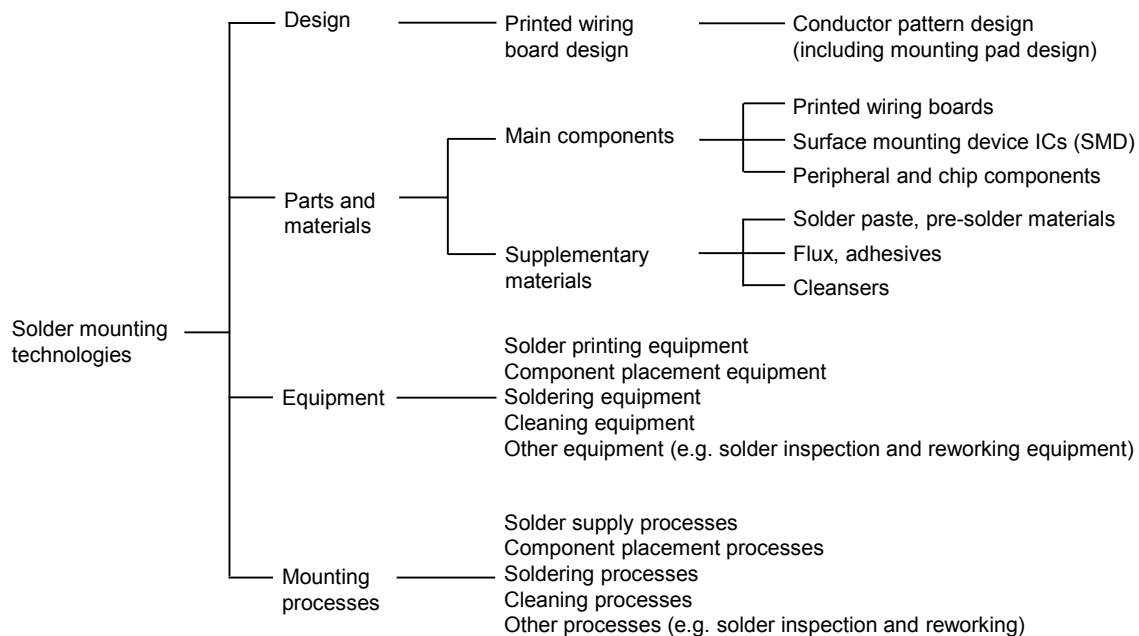


Figure 1.1 Solder Mounting Technologies

1.1 Soldering Methods

1.1.1 Types of Soldering Method

Soldering methods are broadly divided into two types: the partial heating method and the total heating method.

Partial heating method: Heat is applied to the package leads and/or PWB in a localized manner.

[Types] There are four types of soldering methods:

1. Soldering iron
2. Hot air
3. Laser
4. Pulse heating

[Feature] Partial heating involves less heat stress on the device and printed wiring board, but is unsuitable for large volume production. Therefore, this method is mainly used to correct soldering or for devices with a low heat resistance.

Total heating method: Heat is applied to the entire package and/or PWB.

[Types] There are two types of soldering methods:

1. Infrared reflow
2. Convection reflow
3. Infrared convection combined
4. VPS (Vapor Phase Soldering)
5. Flow (wave) soldering

[Feature] Because of excellence in productivity and running cost, these types are widely used. However, this method can place considerable heat stress on the semiconductor device and board.

Select the soldering method best suited to your application by taking into consideration the advantages and disadvantages of each soldering method, as well as the heat resistance of the SMD.

1.1.2 Features of the Different Soldering Methods

Table 1.1 lists the features of each method. Furthermore, sections 1.1.3 and 1.1.4 discuss the partial heating methods and the total heating methods.

Table 1.1 Soldering Method Features

Soldering (Heating) Method		Features				
Type	Method	Strengths	Weaknesses			
Partial (Local) Heating	Soldering iron method	Thermal stress: low	<ul style="list-style-type: none"> • Temperature variations: large • Running costs: high 			
	Hot air method	Thermal stress: low	<ul style="list-style-type: none"> • Temperature variations: large • Running costs: high 			
	Laser method	<ul style="list-style-type: none"> • Thermal stress: low • Post-soldering is possible 	<ul style="list-style-type: none"> • Not appropriate for mass production (long processing times) • All pins and all components must be heated 			
	Pulse heating method	<ul style="list-style-type: none"> • Thermal stress: low • Post-soldering is possible 	<ul style="list-style-type: none"> • Not appropriate for mass production (long processing times) • All pins and all components must be heated 			
Total Heating	Infrared method (IR reflow)	<ul style="list-style-type: none"> • Running costs: low • Processing times: short • Simple structures 	<ul style="list-style-type: none"> • Temperature variations: large • Thermal stress: high • It is difficult to heat components that are in shadows • Temperature variations arise due to component shapes and colors (for near-IR) 			
	Convection method (convection reflow)	<ul style="list-style-type: none"> • Temperature variations: medium • Direct heating of high density parts and parts that are in shadows is easy • Even heating is possible • An even temperature distribution is reached after a certain amount of time even if the board and components have different thermal capacities. 	<ul style="list-style-type: none"> • Thermal stress: high • Processing times: somewhat longer than those for IR reflow soldering • Component displacement and board vibrations can occur due to the flow speed. 			
				Air	Running costs: low	Solder defects due to copper foil oxidation can occur
		N2	It is difficult for solder defects due to copper foil oxidation to occur.	Running costs: high		
	Combined IR/ convection method	<ul style="list-style-type: none"> • Temperature variations: medium • Processing times: short • Direct heating of high density parts and parts that are in shadows is easy • Even heating is possible • An even temperature distribution is reached after a certain amount of time even if the board and components have different thermal capacities. 	<ul style="list-style-type: none"> • Thermal stress: high • Component displacement and board vibrations can occur due to the flow speed. • Solder defects due to copper foil oxidation can occur (for convection reflow soldering) 			
				Air	Running costs: low	Solder defects due to copper foil oxidation can occur
				N2	It is difficult for solder defects due to copper foil oxidation to occur.	Running costs: high
	VPS (vapor phase soldering)	<ul style="list-style-type: none"> • Temperature variations: small • Precise temperature control is possible • No temperature control system is required • The heating temperature can be made lower and the time shorter • Minimal oxidation and contamination of soldered sections 	<ul style="list-style-type: none"> • Thermal stress: high • Running costs: high • Equipment costs: high 			
	Flow soldering (wave soldering)	<ul style="list-style-type: none"> • Running costs: low • Processing times: short • Thermal stress: low (THD) 	<ul style="list-style-type: none"> • Temperature variations: large • Handling diverse packages (such as fine lead pitch packages) is difficult • Thermal stress: high (SMD) 			

1.1.3 Partial Heat Methods

(1) Soldering Iron Method

In this method, the package leads are soldered to the mounting pads on the printed wiring board using a soldering iron and wire solder.

The thermal capacity of the soldering iron used must be determined based on the size and shapes of the places to be soldered and the melting point of the solder.

Care is required, since increasing the temperature more than necessary can lead to degradation due to exceeding heat tolerances, for example peeling of the mounting pads from the printed wiring board.

Since the actual temperatures of the places soldered depend on the heating capacity of the soldering iron (the heat source) and the thermal capacities of the package and mounting board, it is necessary to take these issues into account by, for example, measuring thermal characteristics before starting work. Also, soldering irons with temperature adjustments should be used if at all possible.

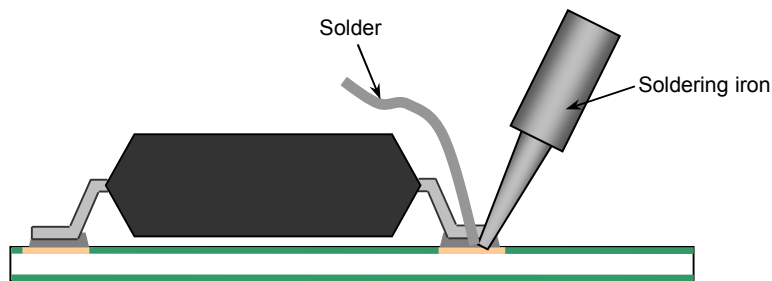


Figure 1.2 Soldering Iron Method

(2) Hot Air Soldering

This method solders the SMD by heating air or N₂ gas with a heater and flowing hot gas from a nozzle onto the joint on the PWB. The temperature is adjusted by adjusting the heat source and/or the flow of gas.

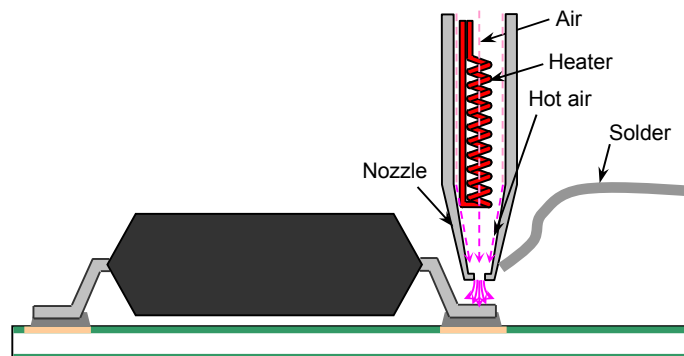


Figure 1.3 Hot Air Method

(3) Laser Method

In this method, devices are soldered by heating with a laser beam. The temperature is adjusted by adjusting the intensity of the laser output and by changing the heating time.

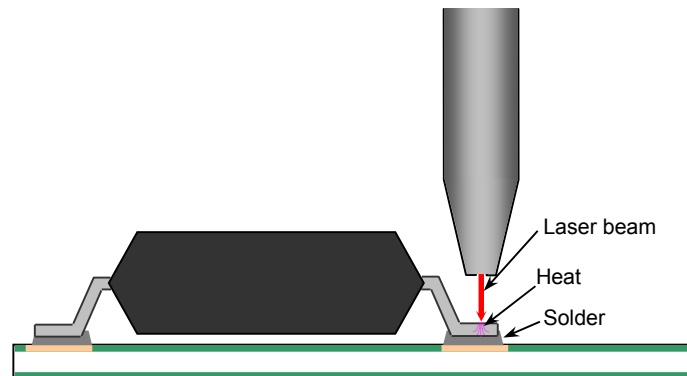


Figure 1.4 Laser Method

(4) Pulse Heating Method

In this method, the Joule heating that occurs due to a current pulse in the tool is used for soldering. The temperature is adjusted by adjusting the amount of current and the time for which the current is applied.

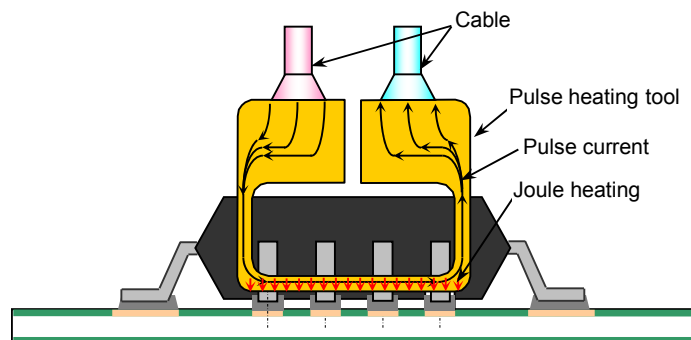


Figure 1.5 Pulse Heating Method

1.1.4 Total Heating Methods

Total heating methods include infrared methods, VPS (vapor phase soldering), and convection methods. These methods differ in the path over which heat is applied as shown below.

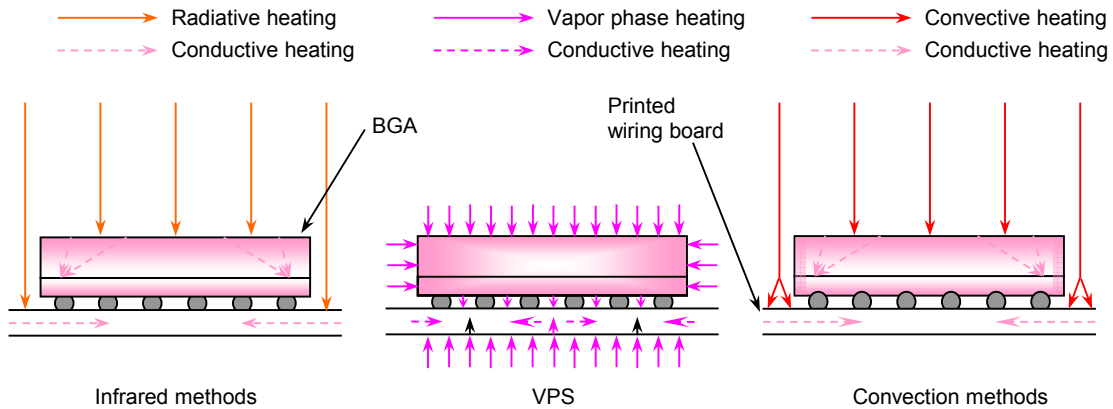


Figure 1.6 Heat Transmission Paths for Different Heating Methods

As can clearly be seen from the transmission paths, for IR methods (IR reflow), soldering sections that are in the package shadow are heated indirectly by transmission heating. Since it is easy for uneven temperatures to occur, convection methods (air or N2 reflow) are mostly used when soldering is performed in the areas under packages such as BGA and LGA packages.

Users must establish mounting (heating) conditions that allow adequate solder wetting of all pins to assure adequate connection strength and reliability.

Figure 1.7 shows cross sectional photographs of solder joints for representative packages mounted with a Sn-3.0Ag-0.5Cu solder.


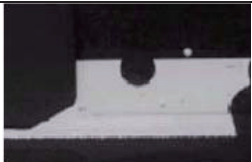
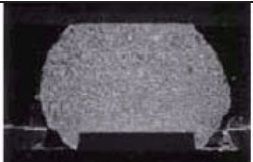

100 pin QFP 0.5 mm pitch	28 pin QFN 0.5 mm pitch	261 pin BGA 0.65 mm pitch	64 pin LGA 0.65 mm pitch
			

Figure 1.7 Post-Mounting Cross Sectional Photographs for Representative Packages Using a Sn-3.0Ag-0.5Cu Solder

(1) IR Method (IR Reflow)

In this method, components are heated by emitted IR radiation (radiative heating) using an IR heater as the heat source.

Since the radiative efficiency for IR heating differs with the structural materials and the shape of the components, temperature differences arise due to differences between the packages (devices).

IR reflow soldering has the following characteristics.

1. Advantages

- Superlative running costs and ease of maintenance
- Short soldering times

2. Disadvantages

- The pin temperature increase depends strongly on the package size.
- It is difficult to raise the temperature of areas in shadows where the IR radiation does hit.
- As a result of the above two phenomena, it is easy for differences in temperature to arise in the printed wiring board and components (places being soldered). As a result, it is necessary to set process conditions based on the places that are the most difficult to heat, and there is a tendency for large thermal stresses to be applied to packages.

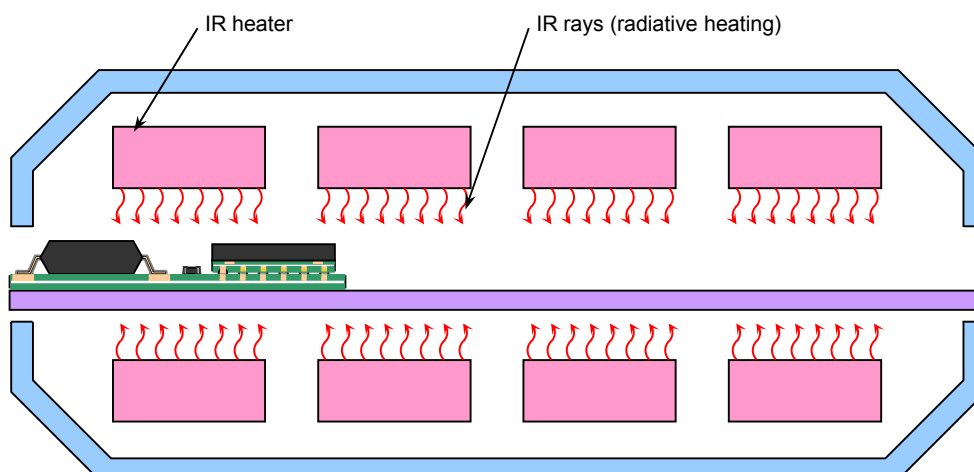


Figure 1.8 IR Method (Example)

(2) VPS (Vapor Phase Soldering Method)

In this method, a special inert liquid is heated by a heater and the product to be soldered is immersed in the saturated vapor atmosphere acquired by the boiling of that liquid, and the vapor that contacts the product releases its latent heat of vaporation as it condenses. This results in highly efficient and even soldering of the product.

Figure 1.9 shows the structure of the equipment used in this method. This equipment consists of the first vapor phase used for the batch reflow soldering, a preheater, cooling, and a second vapor phase to prevent splashing of the liquid from the first vapor phase.

Vapor phase soldering has the following characteristics.

1. Advantages

- The efficiency with which heat is transmitted to the work is extremely high and the whole work is heated evenly regardless of the shapes of the components.
- Since the latent heat of vaporation is used, the temperature can be controlled precisely.
- Since soldering is performed in an inert atmosphere, there is minimal oxidation or contamination of the soldered sections.
- As a result of the above features, the heating conditions can be kept low and the processing times can be short. As a result, the thermal stress applied to the packages is minimal.

2. Disadvantages

- High running costs.

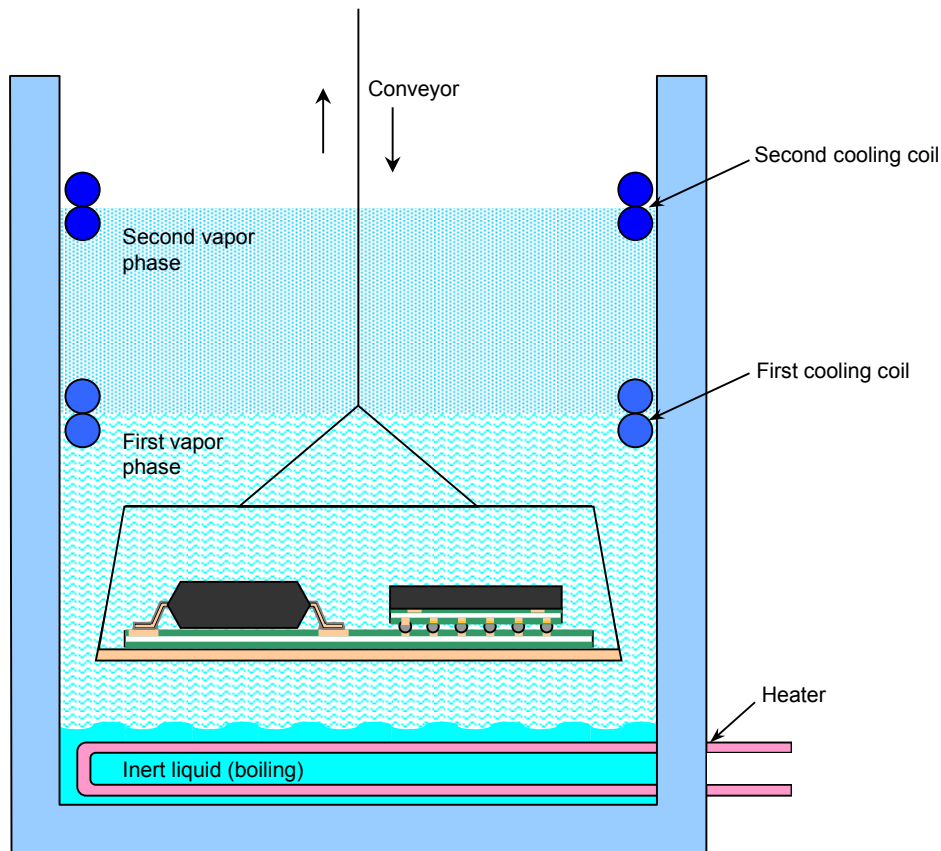


Figure 1.9 Vapor Phase Soldering Method (Example)

(3) Convection Reflow Method (Air or N2 Reflow)

This is a method that resolves the problems of uneven heating of the printed wiring board and components in IR reflow and of high running costs of VPS (see section 1.1.4 (2)).

The basic principle of convection reflow soldering is that an atmosphere (air or N2) heated by a heater is circulated within a furnace and heat is transmitted to the work by convection heating to perform the soldering. The result of this process is that an even temperature distribution is achieved after a fixed time even if there are differences in thermal capacities between the board and components.

Convection reflow (hot air) soldering has the following characteristics.

1. Advantages
 - Superlative temperature evenness compared to IR methods (IR reflow).
(The temperature is not significantly affected by the objects being heated.)
 - Comparatively low thermal stress.
2. Disadvantages
 - The soldering time tends to be longer than that for IR reflow.

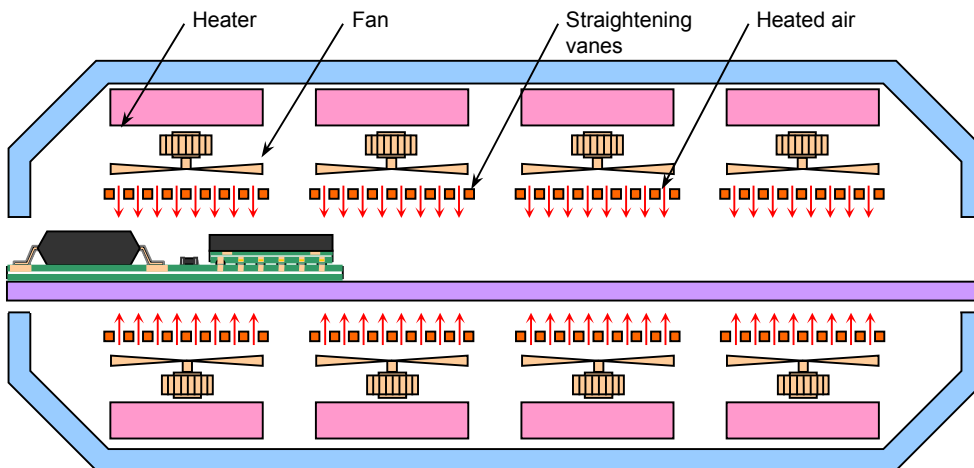


Figure 1.10 Convection Reflow Method (Example)

(4) Combined Convection IR Method (Convection/IR Reflow)

In this method, convection and IR heating are combined to decrease the soldering time, which is a disadvantage of the previous method (convection reflow).

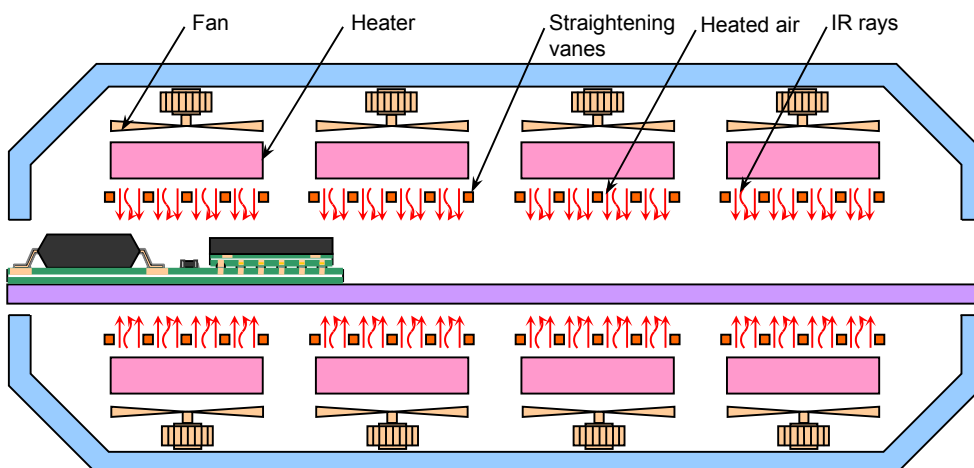


Figure 1.11 Convection Reflow Method (Example)

(5) Flow (Wave Soldering) Method

In this method, solder melted in a tank flows onto the work to perform the soldering.

The printed wiring board is immersed in the flowing melted solder.

This method has the following characteristics.

1. Advantages
 - It is superb for mass production (soldering can be completed in a few seconds).
2. Disadvantages
 - It is difficult to use with diverse package types, especially ball type SMD packages and narrow lead pitch SMD packages.

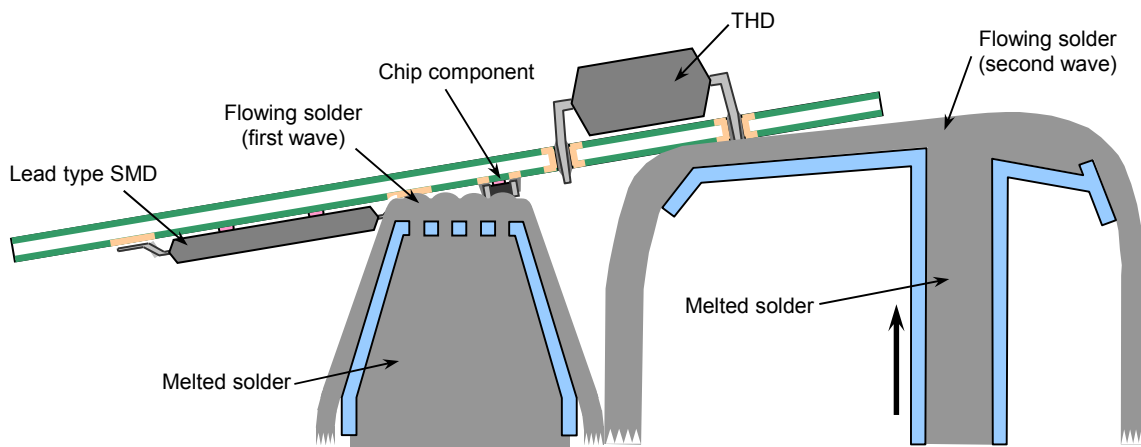


Figure 1.12 Flow (Wave Soldering) Method (Example)

1.1.5 Adaptation by Package Types

Available soldering methods due to package type.

An example where soldering methods are classified by package is shown below.

Select the soldering method best suited to your application by taking into consideration the advantages and disadvantages of each soldering method, as well as the heat resistance of the parts.

Table 1.2 Soldering Method Applicability by Package Type

Soldering Method		SIP DIP SDIP	SOP SSOP HSOP QFP LQFP HQFP HLQFP	TQFP HTQFP TSOP HTSOP	TSSOP VSSOP P-VSON HSOI G-QFP	QFJ SOJ	QFN P-VQFN BGA LFBGA HBGA HFBGA TFBGA LGA	MFPAK SMPAK CMPAC SMFPAK TSOP-6 LDPAK(S) *4	LFAK G-QFJ	HQFP*4 HLQFP*4 HTQFP*4 HSOP*4 HTSOP*4 HTSSOP*4 HSOI*4 HQFN*4 RP8P*4	SFP	DKPAK(S)*4 and other discrete packages
Partial Heating (Local Heating)	Soldering iron	○	○	○	○	○	×	○*5	○	×	×	○*5
	Hot air	○	○	○	○	○	○	○	○	○	○	○
	Laser	○	○	○	○	×	×	○	×	×	○	○
	Pulse heater	×	○	○	×	×	×	○	×	×	○	○
Total Heating	IR, convection, and combined reflow	×	○	○	○	○	○	○	○	○	○	○
	VPS	×	○	○	○	○	○	○	○	○	○	○
	Wave soldering*3	○	○*1	○*1*2	×	○	×	×	×	×	○	○

○: Applicable

×: Not applicable (This combination should be avoided)

Notes: 1.

Pin pitch (mm)	1.27	1.0	0.8	0.65	0.5	0.4
Soldering	Applicable				Problematic	

The ability to withstand heat differs between individual semiconductor products. Contact your Renesas sales representative for details.

- There are also certain products for which the maximum solder tank temperature is 235°C and the maximum solder tank pass-through time is 5 seconds.
- Solder bridges and other problems may occur with fine pitch devices. Only use this combination after verifying mountability.
- Exposed heat spreader and exposed die pad types
- Avoid heating heat spreaders (or die pads) with the soldering iron.

1.1.6 Solder Mounting Processes

Solder mounting processes can be classified into those that support printed wiring boards with components mounted on only one side and those that support printed wiring boards with components mounted on both sides. Also, packages mounted on printed wiring board can be classified into lead insertion types (THD) and surface mounting types (SMD). Since there are soldering processes that are appropriate for each of these, there are basically six types of process.

1.1.7 Basic Mounting Processes

- Single-sided mounting
 - (1) THD flow soldering
 - (2) SMD flow soldering
 - (3) SMD reflow soldering
- Double-sided mounting
 - (1) SMD reflow soldering + THD/SMD flow soldering
 - (2) SMD reflow soldering + SMD reflow soldering
 - (3) THD/SMD flow soldering

Figures 1.13 to 1.18 on the following pages present simplified views of these processes.

In mixed mounting, in which multiple packages of differing types are mounted on the same printed wiring board, the ability to withstand heating of the different devices must be taken into consideration when determining the optimal mounting process.

1.1.8 Single-sided Soldering

(1) Flow Soldering of THD

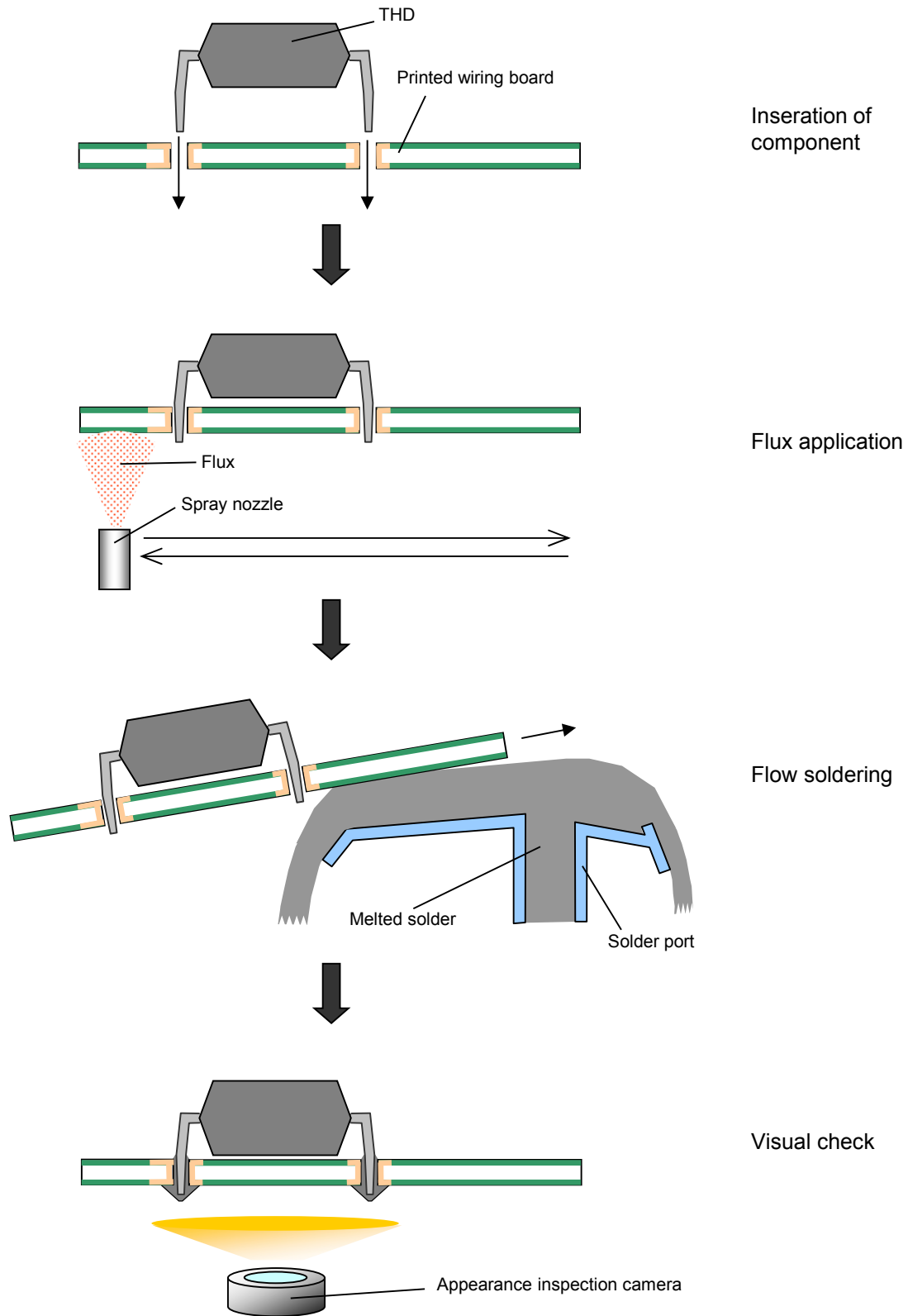


Figure 1.13 THD Flow Soldering

(2) Flow Soldering of SMD

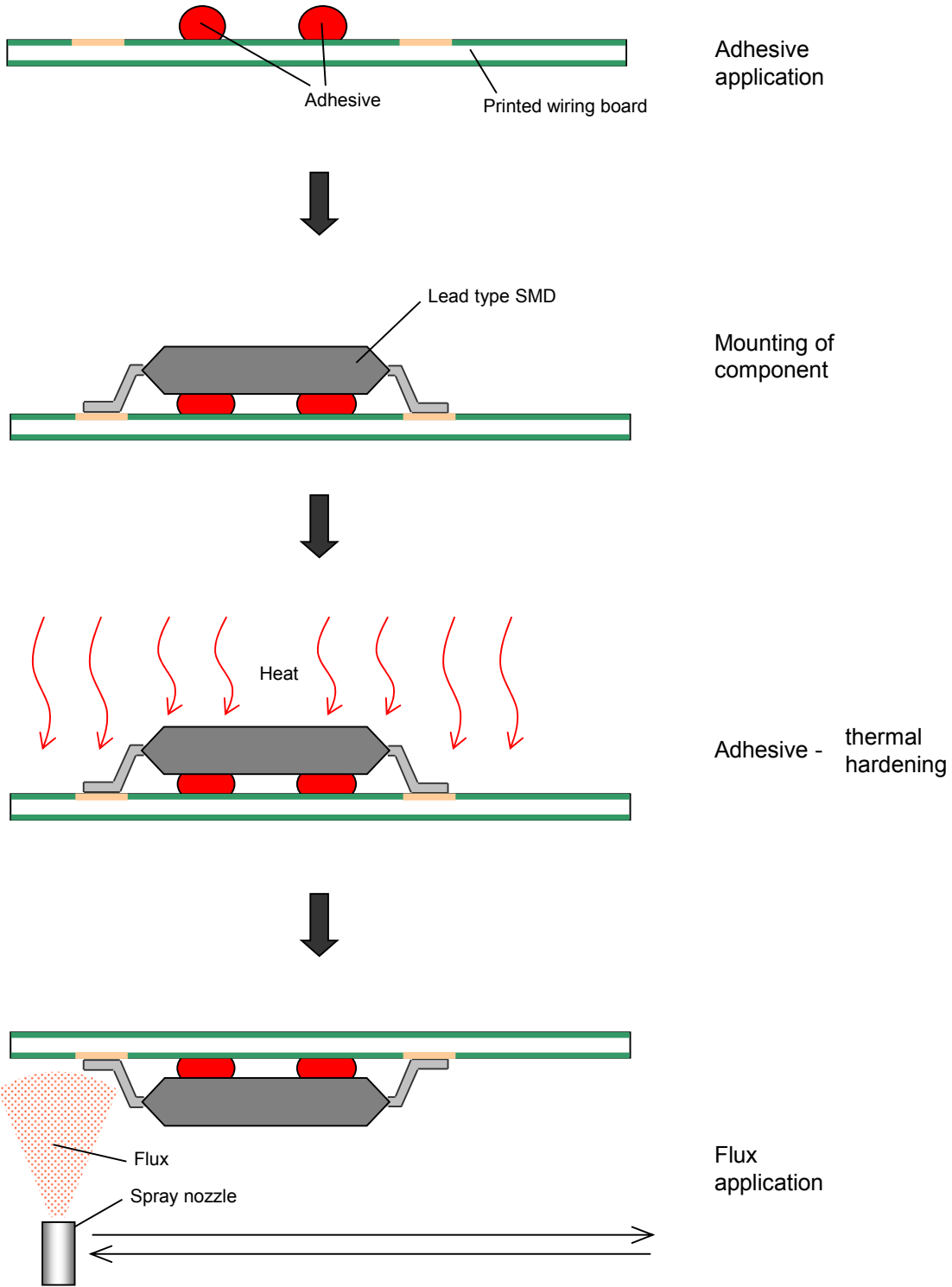


Figure 1.14 SMD Flow Soldering

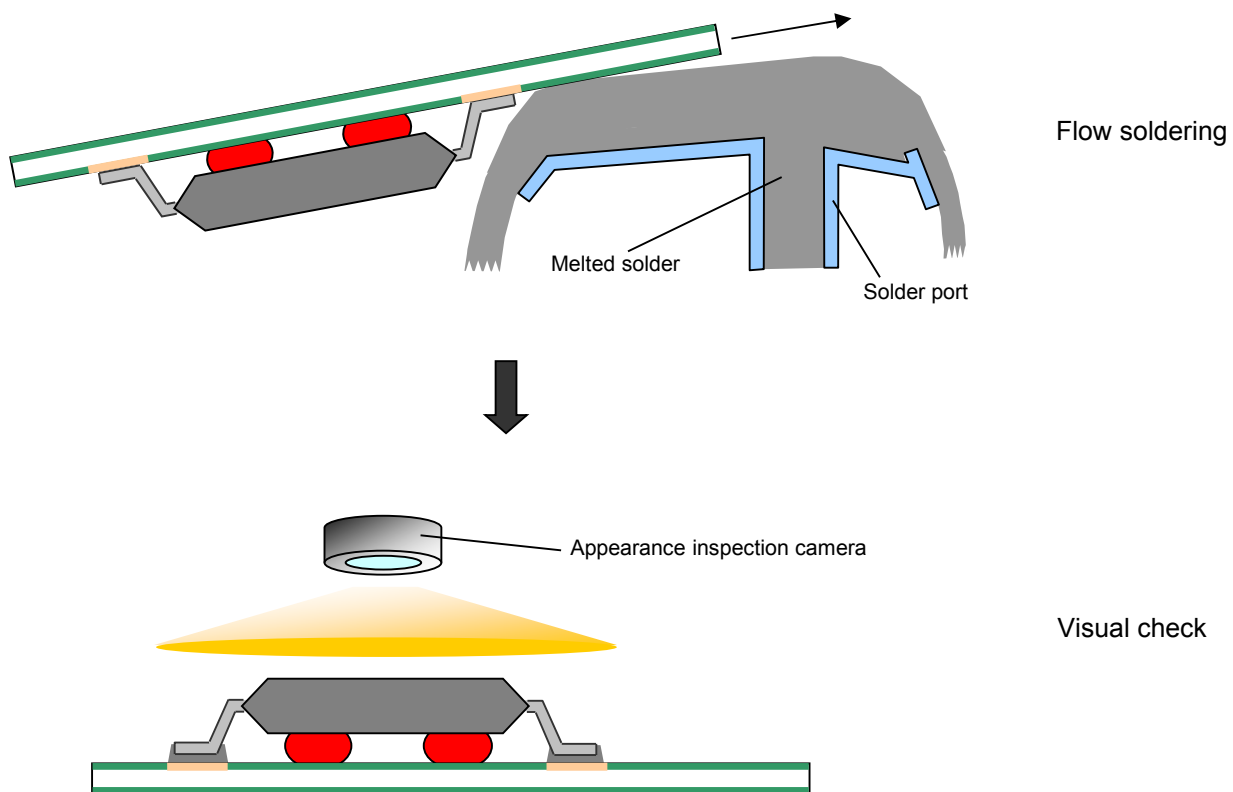


Figure 1.14 SMD Flow Soldering (cont.)

(3) Reflow Soldering of SMD

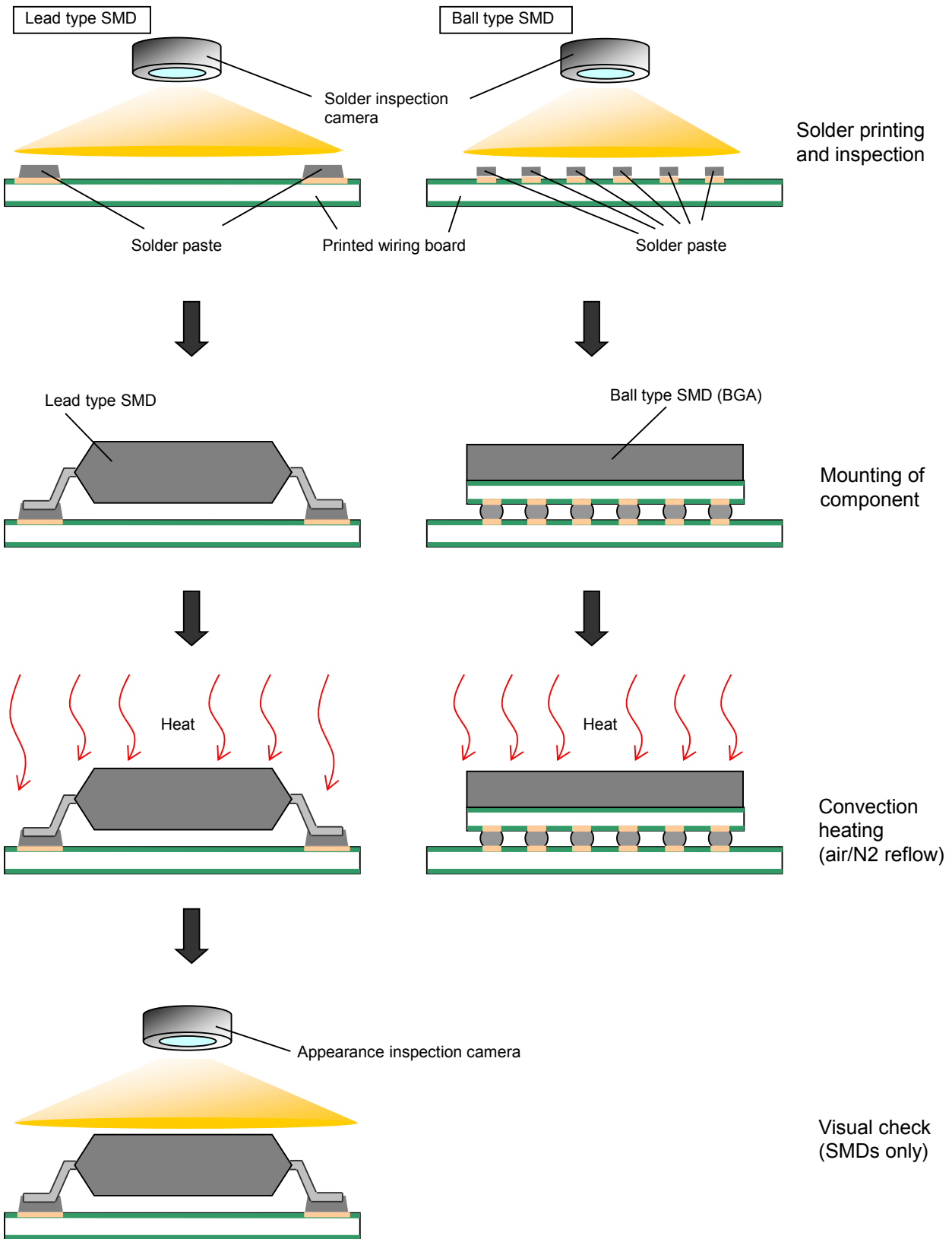


Figure 1.15 SMD Reflow Soldering

1.1.9 Double-sided Soldering

(1) SMD Reflow + THD/SMD Flow Soldering

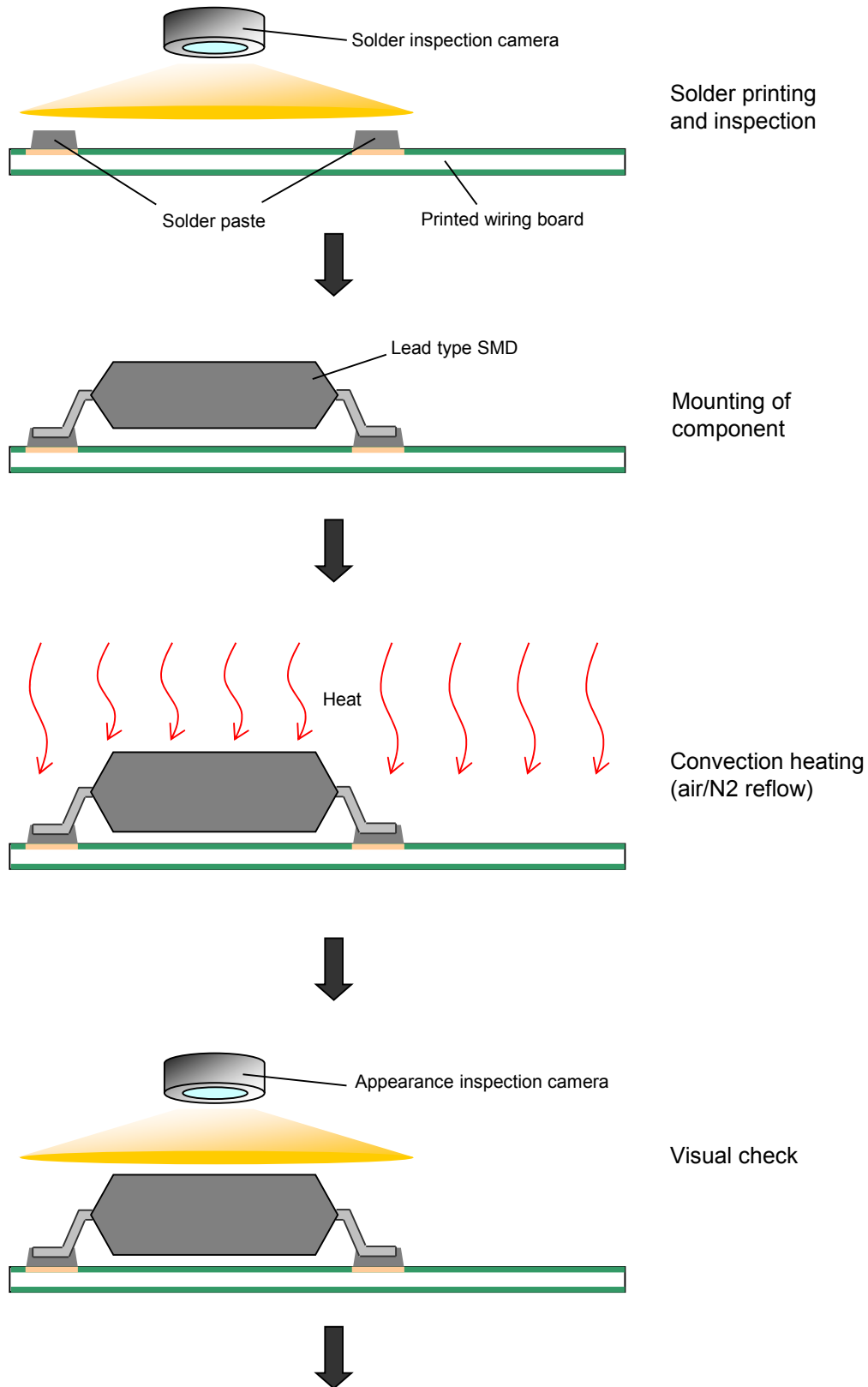


Figure 1.16 SMD Reflow + THD/Lead-Type SMD Flow Soldering

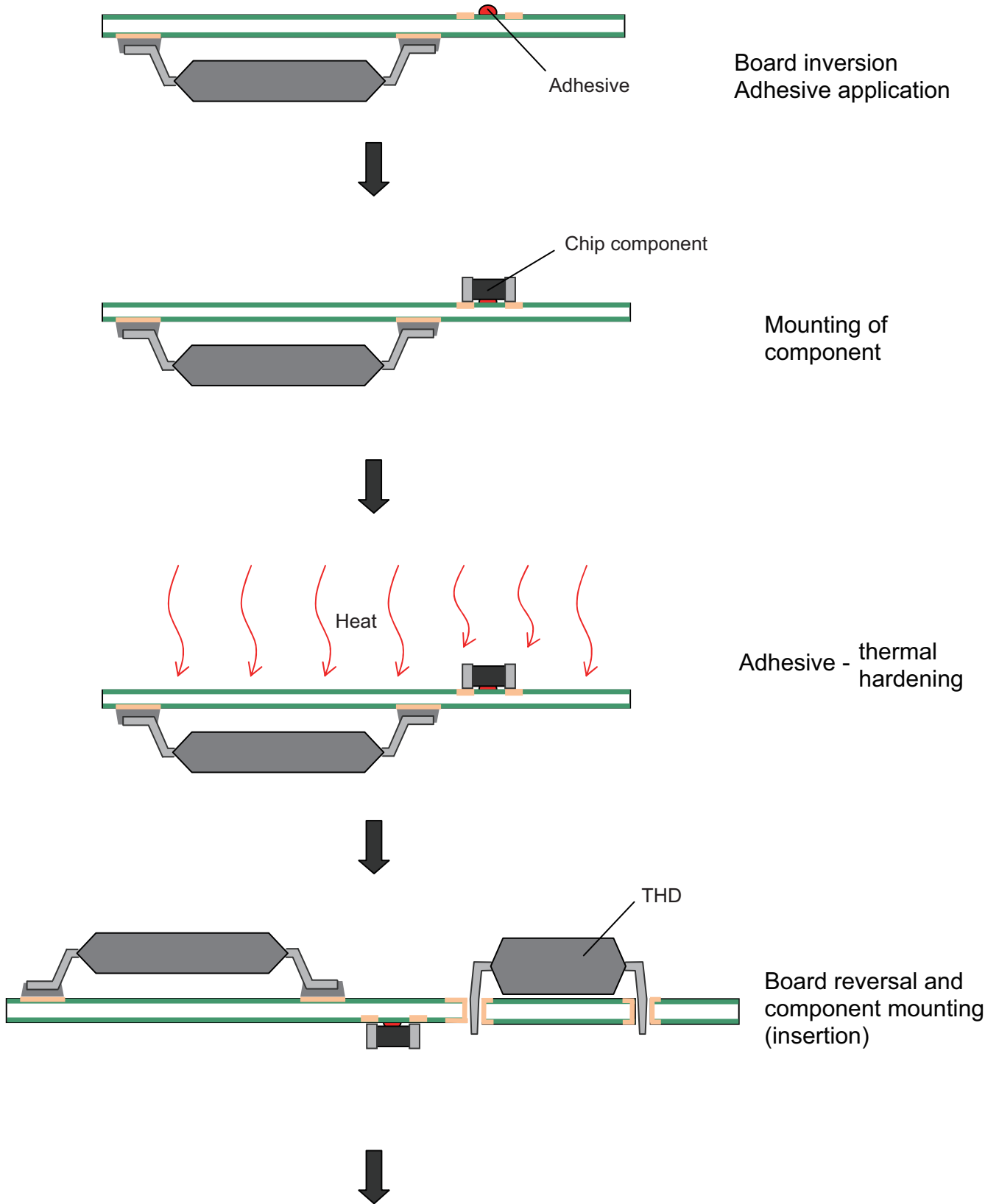


Figure 1.16 SMD Reflow + THD/Lead-Type SMD Flow Soldering (cont.)

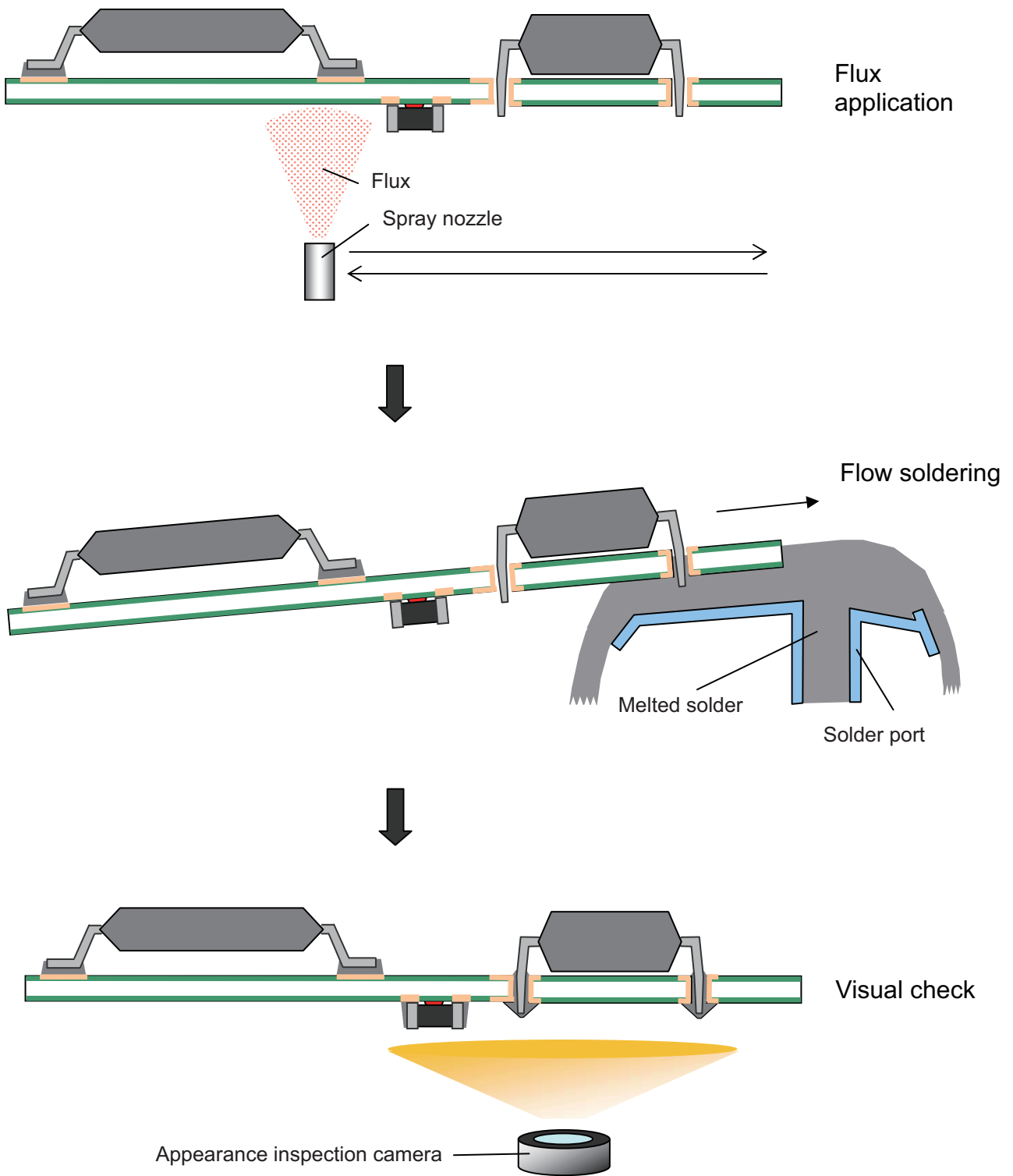


Figure 1.16 SMD Reflow + THD/Lead-Type SMD Flow Soldering (cont.)

(2) SMD Reflow + SMD Reflow Soldering

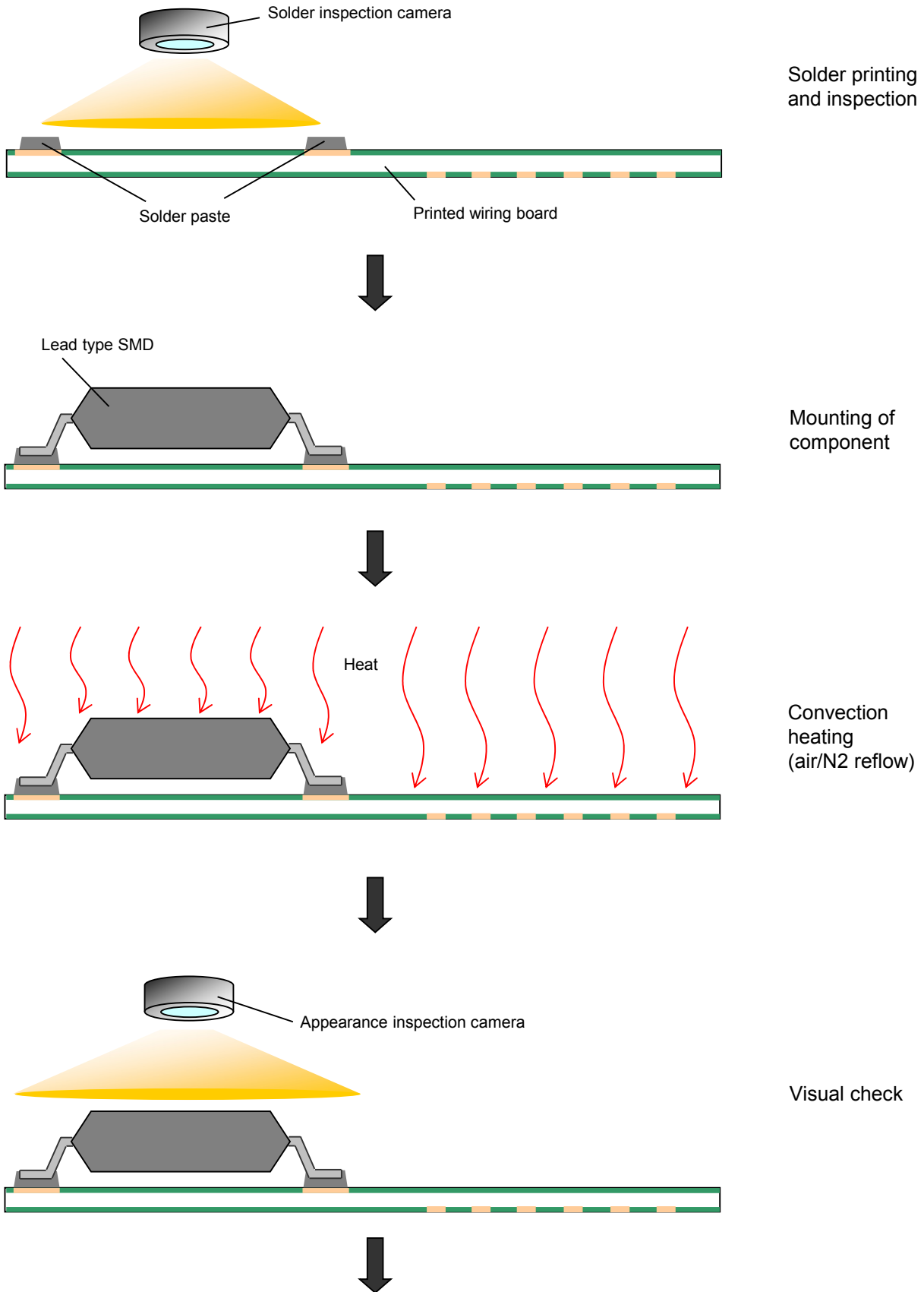


Figure 1.17 SMD Reflow + SMD Reflow Soldering

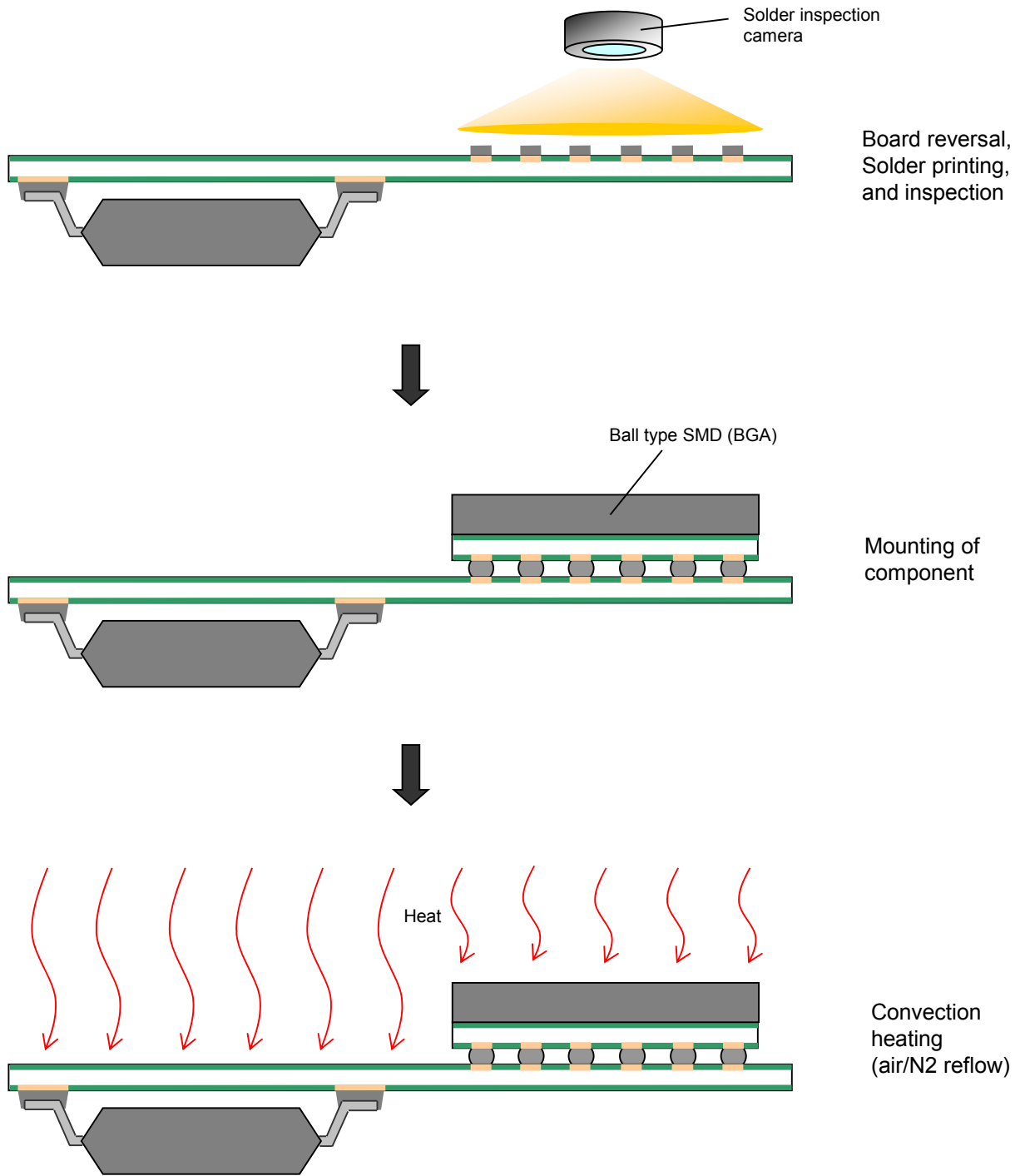


Figure 1.17 SMD Reflow + SMD Reflow Soldering (cont.)

(3) THD/Lead-Type SMD Flow Soldering

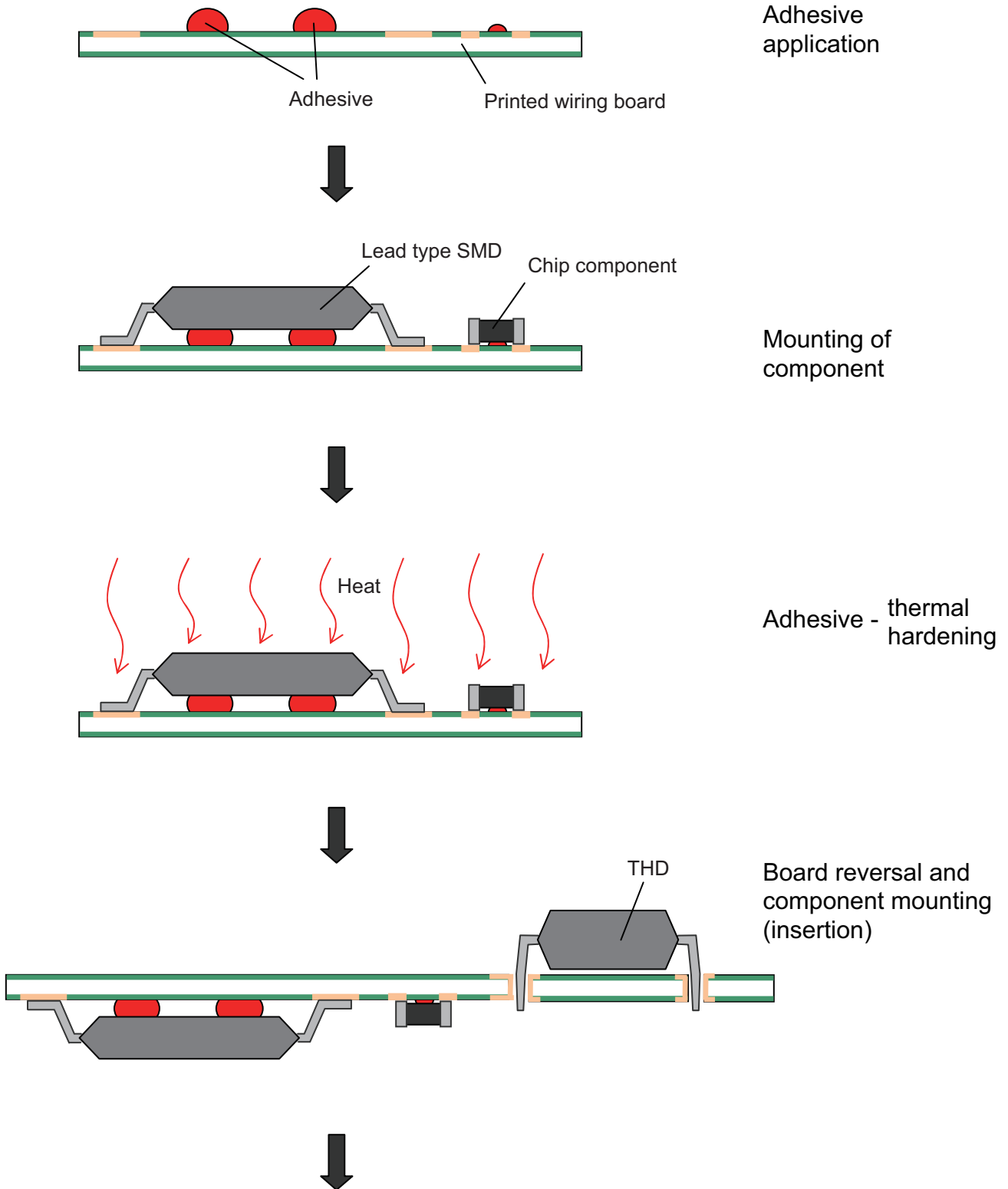


Figure 1.18 THD/Lead-Type SMD Flow Soldering

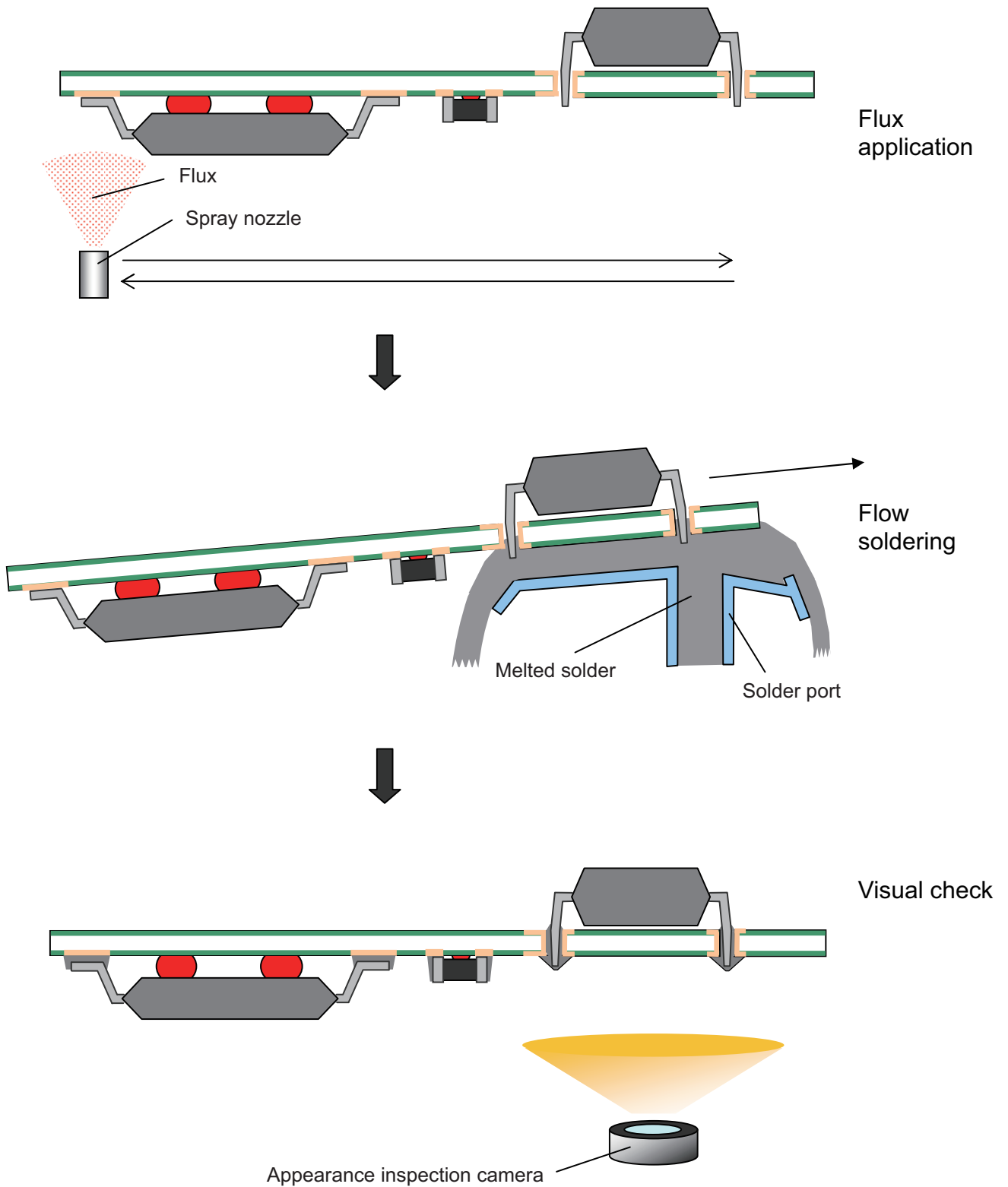


Figure 1.18 THD/Lead-Type SMD Flow Soldering (cont.)

2. Printed Wiring Board Design

2.1 Lead-Type SMDs

In designing the mounting pads for a printed wiring board that mounts lead-type SMD packages, it is important to take the shape of the leads into consideration. Also note that care is required, since there may be subtle differences in pin shapes even between devices with the same package name.

The parameters regulating the mount pad dimensions are as follows.

- Cleanliness: α
- Soldering strength: $\beta 1$
- Pattern precision and ease of visual inspection: $\beta 2$
- Solder bridge tolerance: γ

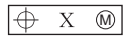
The allowable margins for which are determined by the pattern design philosophy and the device's application.

Below, we describe the design method for the printed wiring board mounting pad dimensions and pin position precision based on package drawings.

2.1.1 Pin Location Range for Lead-Type SMDs

The package pin positions (pin location range), which are critical when designing the mounting pads on a printed wiring board, are stipulated in terms of the tolerances for the pin widths and the pin center positions in the package drawing.

For the pin center position tolerance, the maximum material condition can be expressed as follows.



- Symbol \oplus : This symbol expresses the positional tolerance
- Symbol X: This symbol expresses the tolerance zone for the pin center position
- Symbol \textcircled{M} : This symbol expresses the maximum material condition. That is, the tolerance zone (range) for the pin center position allowed when the pin width is maximum.

The true pin location range is the range from the true center position to the maximum pin width. However, since the pin center position also has a tolerance, the maximum pin location range is the sum of the maximum pin width and the pin center position tolerance zone.

The maximum material condition expresses the fact that the maximum pin location range (the maximum allowable range for a pin) shown above cannot be exceeded regardless of the pin width.

Therefore, when the pin width is narrower than the maximum pin width, the tolerance for the pin center position will be larger.

In the following, we present an example based on a 0.5 mm pitch QFP.

Pin width = 0.2 ± 0.05 mm

Tolerance zone for the pin center position = $\oplus \phi 0.08 \textcircled{M}$

Thus for a 0.5 mm pitch QFP, the maximum pin location range will be 0.33 mm (± 0.165 mm) from the true pin center position.

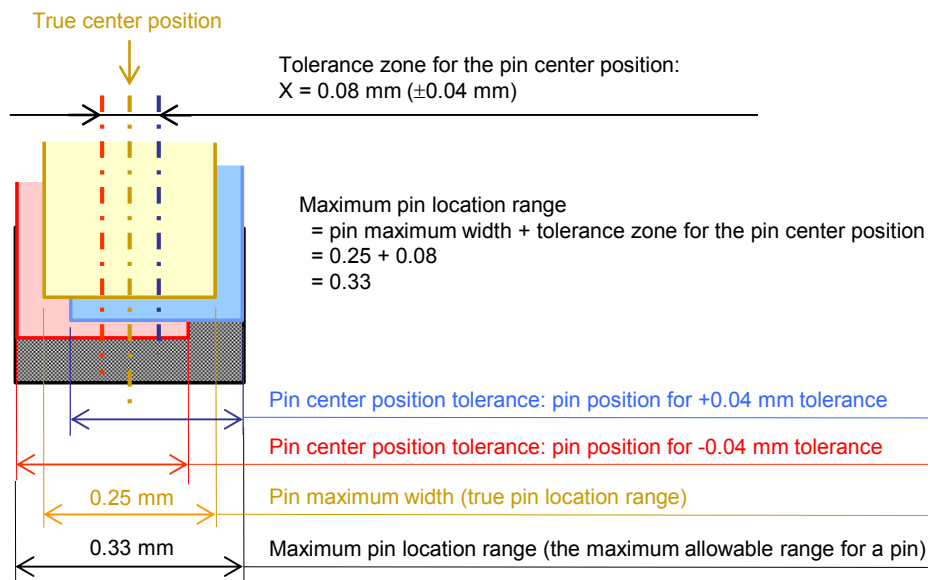


Figure 2.1 Pin Center Position Tolerance for a 0.5 mm Pitch QFP

2.1.2 Dimensional Examples for Different Package Types

(1) Gull Wing Type Packages

- [1] SOP (MIL standard) Figure 2.2
- [2] TSOP (type I, type II), SSOP, LSSOP, TSSOP, VSSOP, and WSOP..... Figure 2.3
- [3] QFP, HQFP, LQFP, TQFP, HLQFP, and HTQFP Figure 2.4
- [4] HQFP, HLQFP, and HTQFP (exposed die pad type) Figure 2.5
- [5] HQFP, HLQFP (Exposed back surface heat spreader type) Figure 2.6

(2) J-Lead Type Packages

- [1] SOJ Figure 2.7
- [2] QFJ Figure 2.8

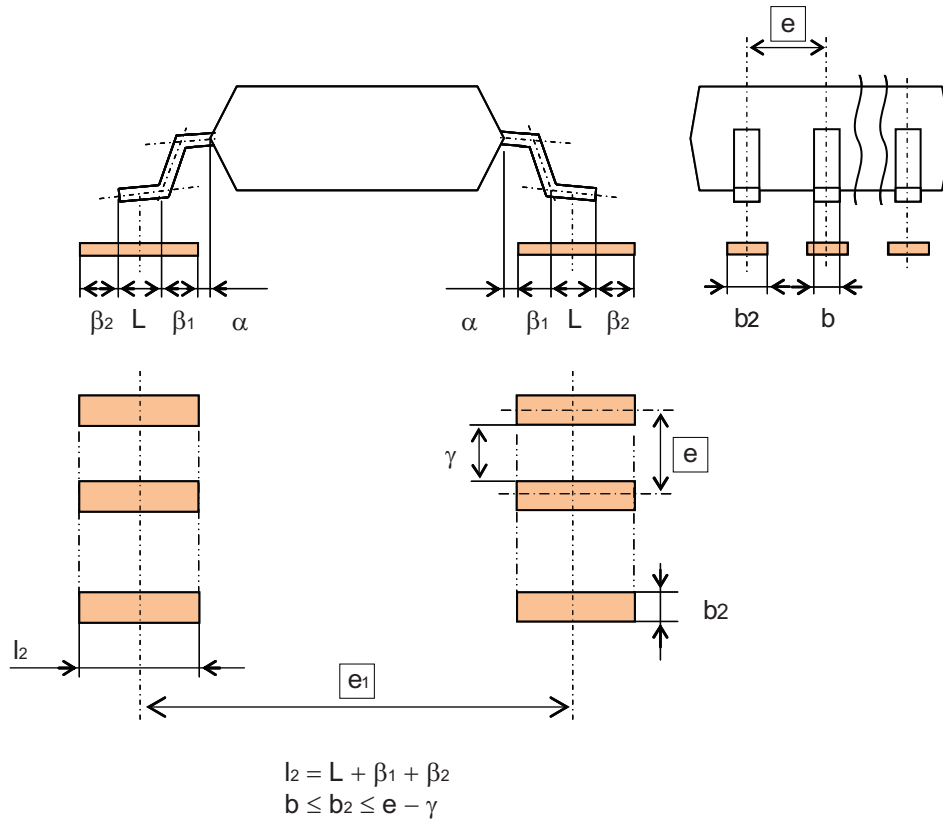
(3) Non-Lead Type Packages

- [2] QFN and HQFN Figure 2.9

(1) Gull Wing Type Package Dimensions

[1] Mounting pad dimensions for SOP (MIL standard) packages

The mounting dimensions are those shown below.



The constants are all the same for the package widths e_1 from type 1 (225 mil) to type 6 (600 mil).

- Package width e_1 types —
- Type 1: 225 mil (5.72)
 - Type 2: 300 mil (7.62)
 - Type 3: 375 mil (9.53)
 - Type 4: 450 mil (11.43)
 - Type 5: 525 mil (13.34)
 - Type 6: 600 mil (15.24)

• Renesas Package Dimension Examples: SOP Type (MIL Standard) Unit: mm

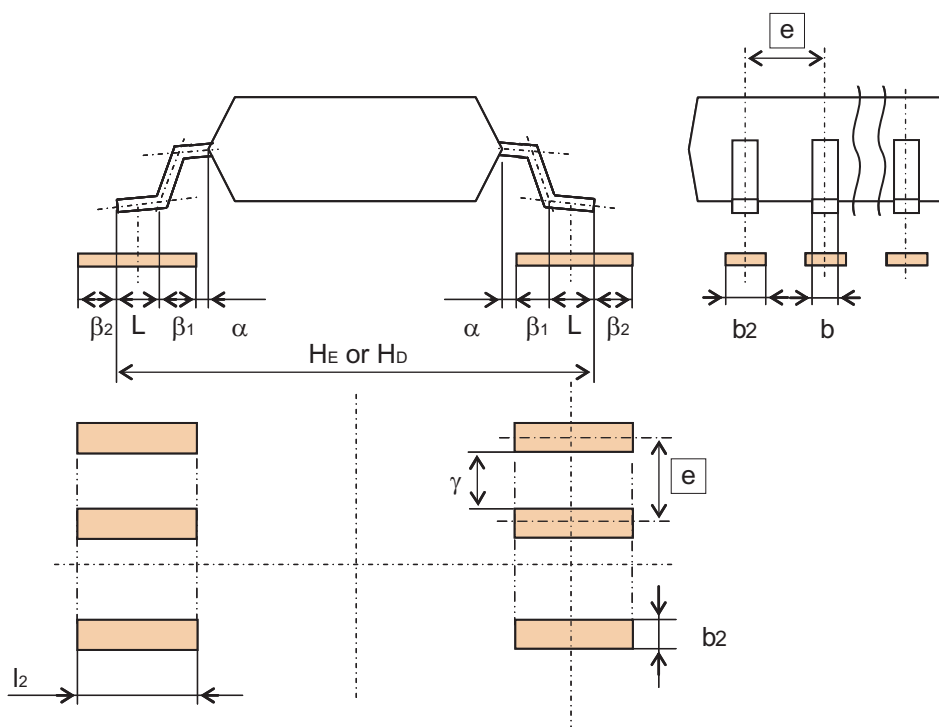
Constant	e	1.27	1.00	0.80	0.65	0.50	0.40
α		0.20 and larger	—	—	—	—	—
β_1		0.20 to 0.50	—	—	—	—	—
β_2		0.20	—	—	—	—	—
γ		0.30	—	—	—	—	—

Note: Reference values based on the former EIAJ ED-7402-1 standard.

Figure 2.2 SOP Type (MIL Standard) Examples

[2] Mounting dimensions for TSOP (type I, type II), SSOP, LSSOP, TSSOP, VSSOP, and WSOP packages

The mounting dimensions are those shown below.



$$l_2 = L + \beta_1 + \beta_2$$

$$b \leq b_2 \leq e - \gamma$$

• Renesas Package Dimension Examples: TSOP type I

Unit: mm

Constant \ e	1.27	1.00	0.80	0.65	0.55	0.50	0.40
α	—	—	—	0.05 to 0.10	←	←	←
β_1	—	—	—	0.20 to 0.25	←	←	←
β_2	—	—	—	0.20 to 0.40	←	←	←
γ	—	—	—	0.30	0.25	←	0.20

• Renesas Package Dimension Examples: TSOP type II

Unit: mm

Constant \ e	1.27	1.00	0.80	0.65	0.55	0.50	0.40
α	0.05 to 0.10	←	←	←	—	—	0.05 to 0.10
β_1	0.20 to 0.25	←	←	←	—	—	0.20 to 0.25
β_2	0.20 to 0.40	←	←	←	—	—	0.20 to 0.40
γ	0.30	←	←	←	—	—	0.20

• Renesas Package Dimension Examples: SSOP, LSSOP, TSSOP, VSSOP, and WSOP

Unit: mm

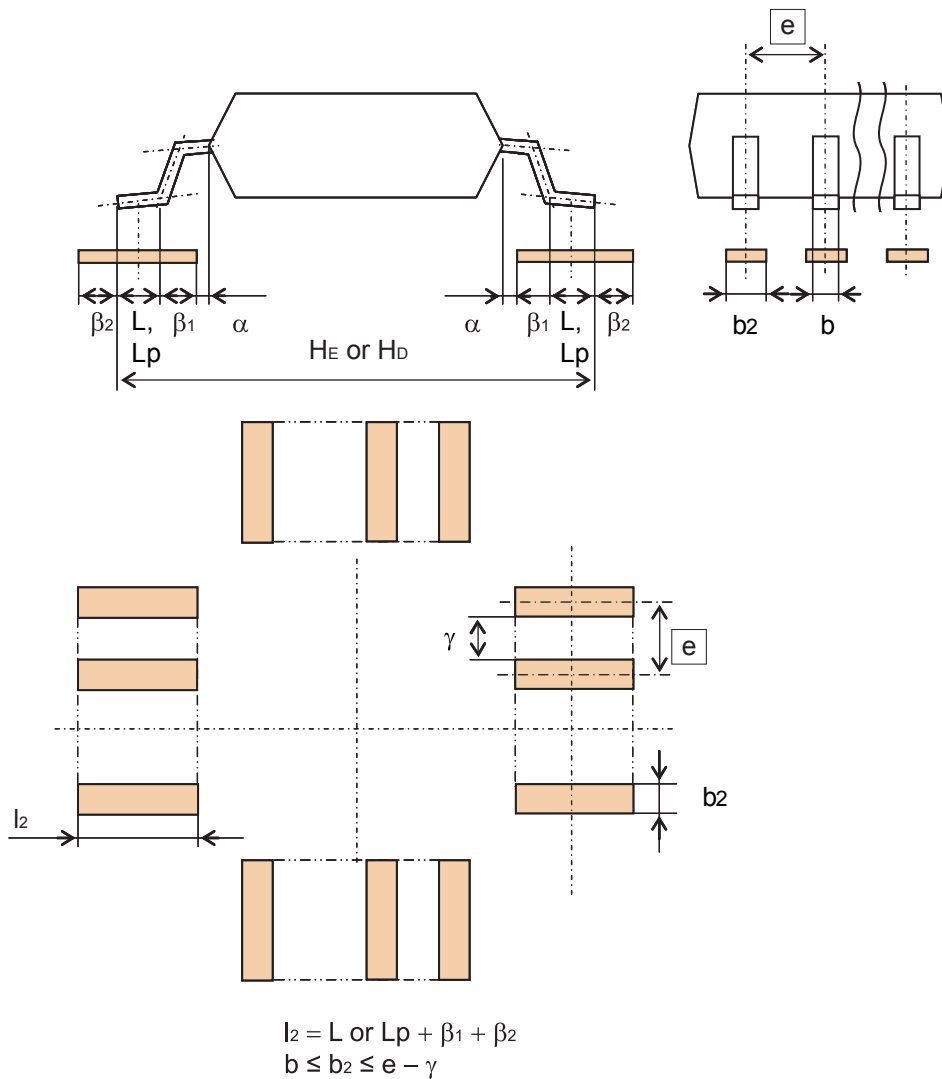
Constant \ e	1.27	1.00	0.80	0.65	0.55	0.50	0.40
α	—	0.10 to 0.30	←	←	—	0.10 to 0.30	←
β_1	—	0.20 to 0.55	←	←	—	0.20 to 0.40	←
β_2	—	0.20 to 0.40	←	←	—	0.20 to 0.40	←
γ	—	0.30	←	←	—	0.25	0.20

Note: Reference values based on the former EIAJ ED-7402 standard.

Figure 2.3 TSOP (type I, type II), SSOP, LSSOP, TSSOP, VSSOP, and WSOP Examples

[3] Mounting dimensions for QFP, HQFP, LQFP, TQFP, HLQFP, and HTQFP packages

The mounting dimensions are those shown below.



□ Renesas Package Dimension Examples:
QFP and HQFP; Products with built-in heat spreaders Unit: mm

Constant \ e	1.00	0.80	0.65	0.50	0.40
α	0.30	←	←	0.10 to 0.30	←
β_1	0.50	←	←	0.20 to 0.40	←
β_2	0.20 to 0.40	←	←	←	←
γ	0.30	←	←	0.25	0.20

□ Renesas Package Dimension Examples:
LQFP, TQFP, HLQFP, and THQFP; Products with built-in heat spreaders Unit: mm

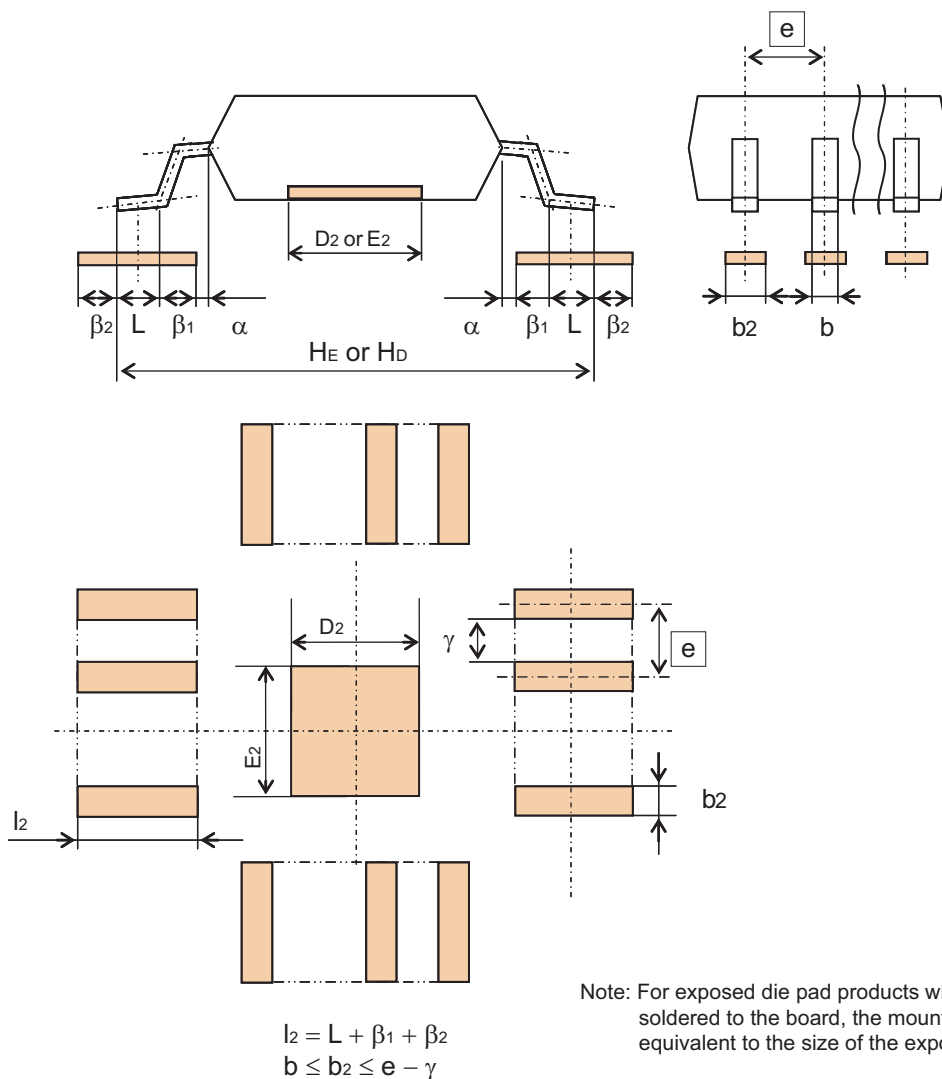
Constant \ e	1.00	0.80	0.65	0.50	0.40
α	0.10 to 0.30	←	←	←	←
β_1	0.20 to 0.40	←	←	←	←
β_2	0.20 to 0.40	←	←	←	←
γ	0.30	←	←	0.25	0.20

Note: Reference values based on the former EIAJ ED-7404 standard.

Figure 2.4 QFP, HQFP, LQFP, TQFP, and HTQFP Examples

[4] Mounting pad dimensions for QFP (HQFP, HLQFP, and HTQFP (exposed die pad type)) packages

The mounting dimensions are those shown below.



Note: For exposed die pad products where the die pad is soldered to the board, the mounting pad dimensions are equivalent to the size of the exposed die pad ($E_2 \times D_2$).

• Renesas Package Dimension Examples:
HQFP (Exposed Die Pad Products)

Unit: mm

Constant	e	1.00	0.80	0.65	0.50	0.40
α		0.30	←	←	0.10 to 0.30	←
β_1		0.50	←	←	0.20 to 0.40	←
β_2		0.20 to 0.40	←	←	←	←
γ		0.30	←	←	0.25	0.20

• Renesas Package Dimension Examples:
HLQFP and HTQFP (Exposed Die Pad Products)

Unit: mm

Constant	e	1.00	0.80	0.65	0.50	0.40
α		0.10 to 0.30	←	←	←	←
β_1		0.20 to 0.40	←	←	←	←
β_2		0.20 to 0.40	←	←	←	←
γ		0.30	←	←	0.25	0.20

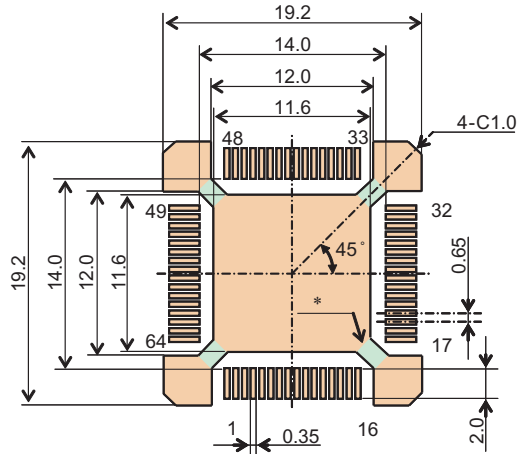
Note: Reference values based on the former EIAJ ED-7404 standard.

Figure 2.5 HQFP, HLQFP, and HTQFP Examples

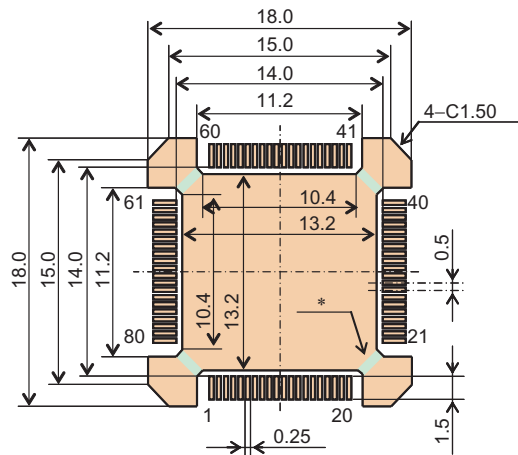
[5] Mounting dimensions for HQFP and HLQFP (Exposed back surface heat spreader type) packages

Mounting pad dimensions: The mounting pad dimensions are designed as shown below.

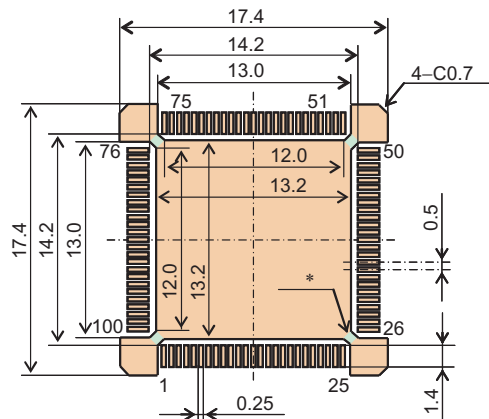
PRQP0064JB-A



PLQP0080KD-A



PLQP0100KD-A



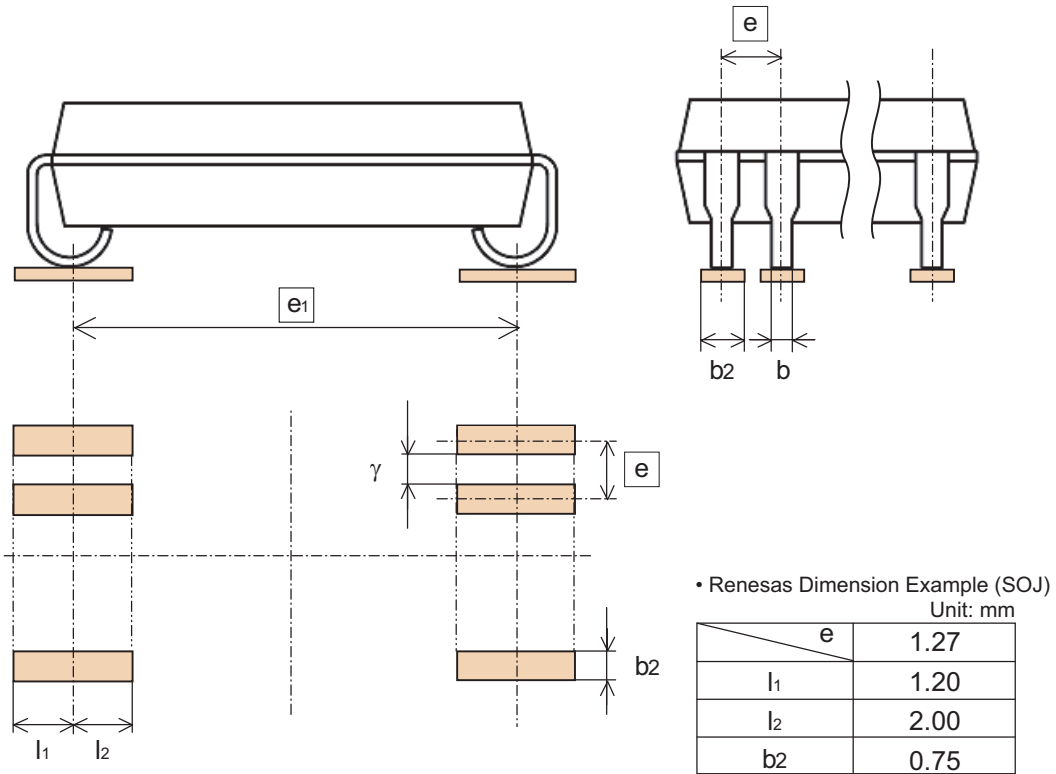
Note: * We recommend setting up silk screen or solder resist features on the board to prevent solder escape during reflow to assure the required amounts of solder for the contact land areas that correspond to the heat spreader corner sections.

Figure 2.6 HQFP and HLQFP (Exposed back surface heat spreader type) Examples

(2) J-Lead Type Package Dimensions

[1] Mounting pad dimensions for SOJ packages

The mounting dimensions are those shown below.

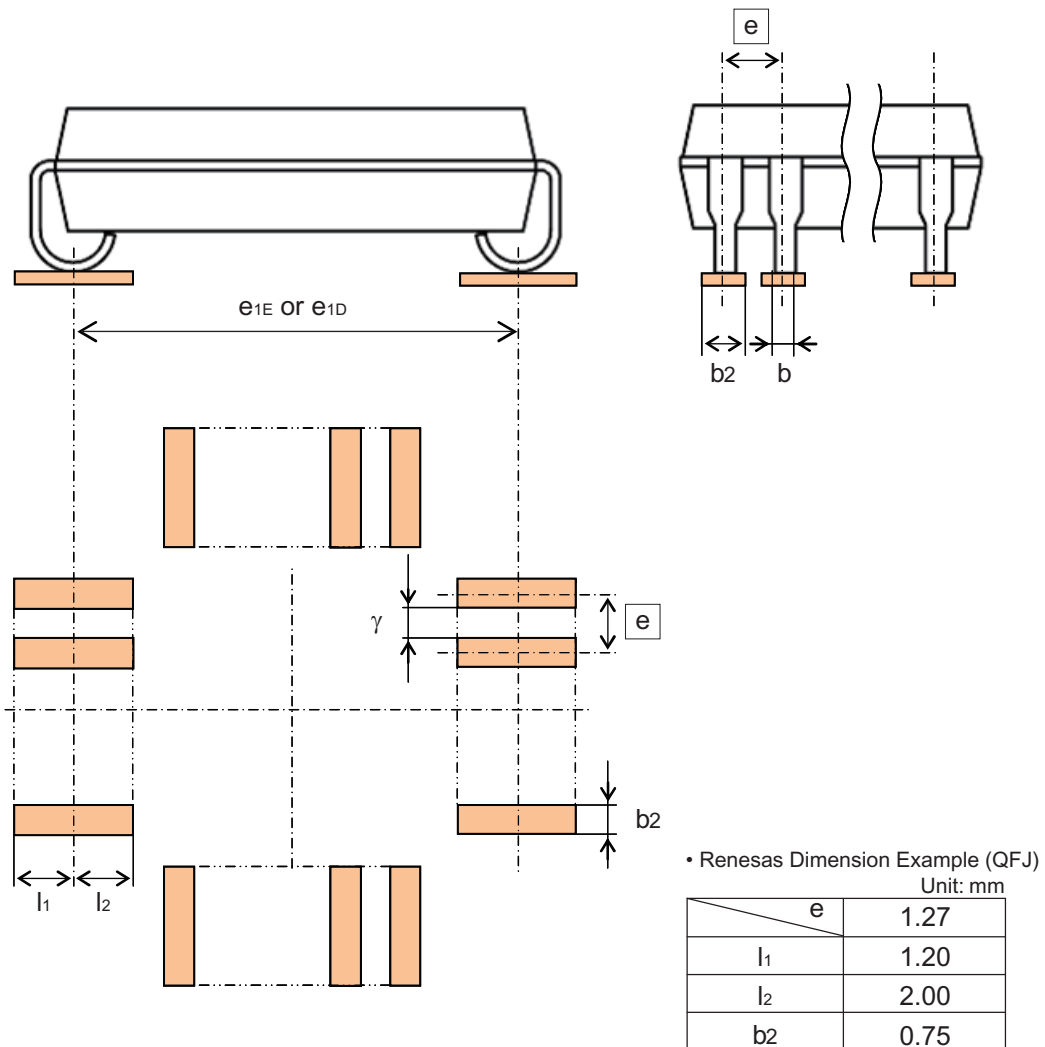


Note: Reference values based on the former EIAJ ED-7406 standard.

Figure 2.7 SOJ Example

[2] Mounting pad dimensions for QFJ packages

The mounting dimensions are those shown below.



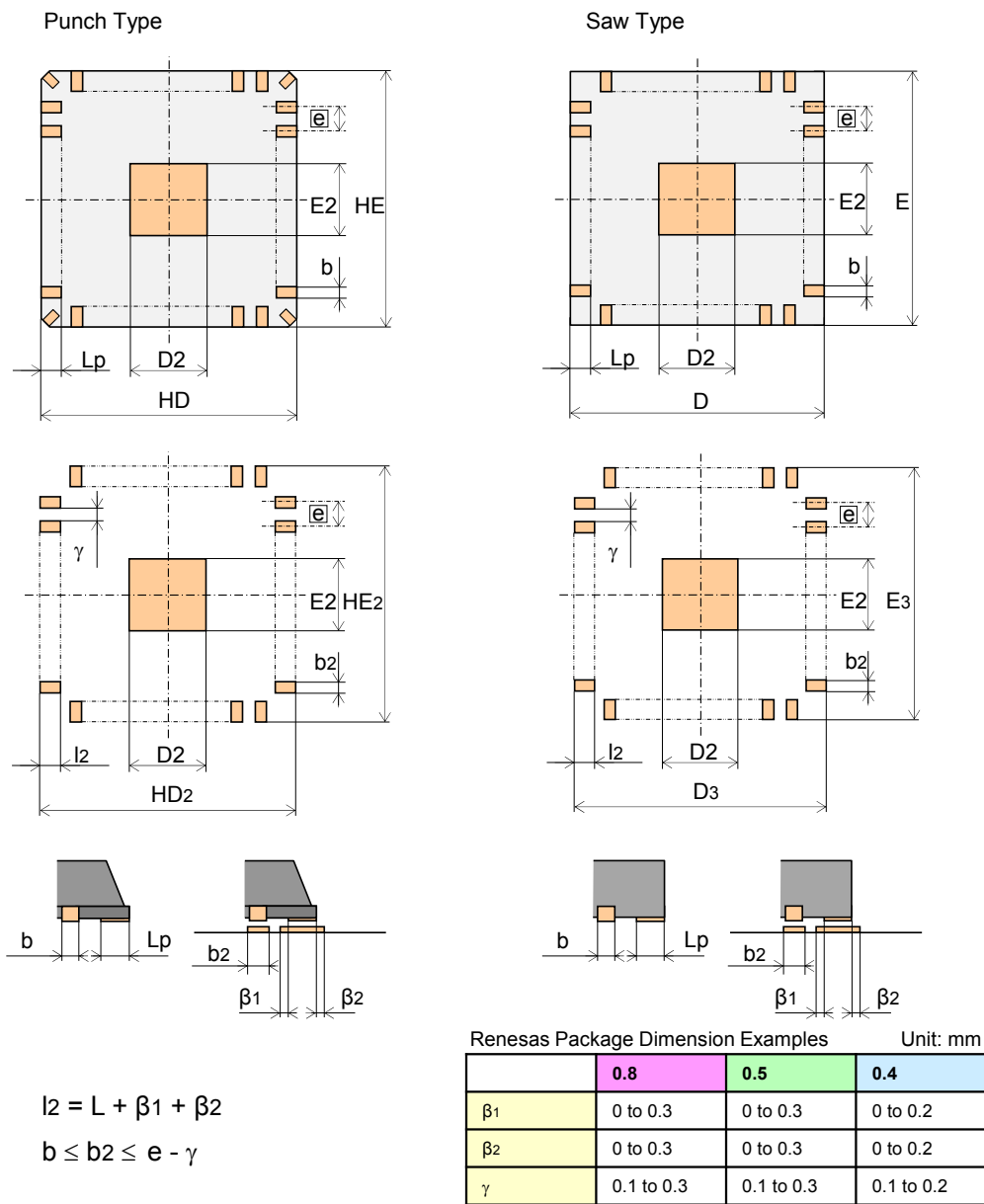
Note: Reference values based on the former EIAJ ED-7407 standard.

Figure 2.8 QFJ Example

(3) Non-Lead Type Package Dimensions

[1] Mounting pad dimensions for QFN and HQFN packages

The mounting dimensions are those shown below.



- When die pads are soldered, the mounting lands are designed to have the same size as the exposed die pad size.
- Avoid mounting leads that are exposed at the package corners (die pad hanging leads) on the printed wiring board.
- If required, the corner land β_1 dimension should be analyzed further.

Figure 2.9 QFN and HQFN Examples

2.2 Ball-Type SMD (Including LGA) Packages

2.2.1 Pin Positions (Areas) for Ball-Type SMD Packages

Since, unlike the lead-type SMD packages, the pin shape for ball-type SMD packages is a circle (or sphere). Therefore the pin width and pin center position tolerances are expressed as diameters (ϕ).

In the following, we present an example of a 0.5 mm pitch FBGA package.

Pin width = $\phi 0.30 \pm 0.05$ mm

Pin center position tolerance zone = $\text{M} \left(\text{M} \phi 0.05 \right)$

Thus for a 0.5 mm pitch FBGA package, the maximum pin location range will be $\phi 0.40$ mm from the true pin center position.

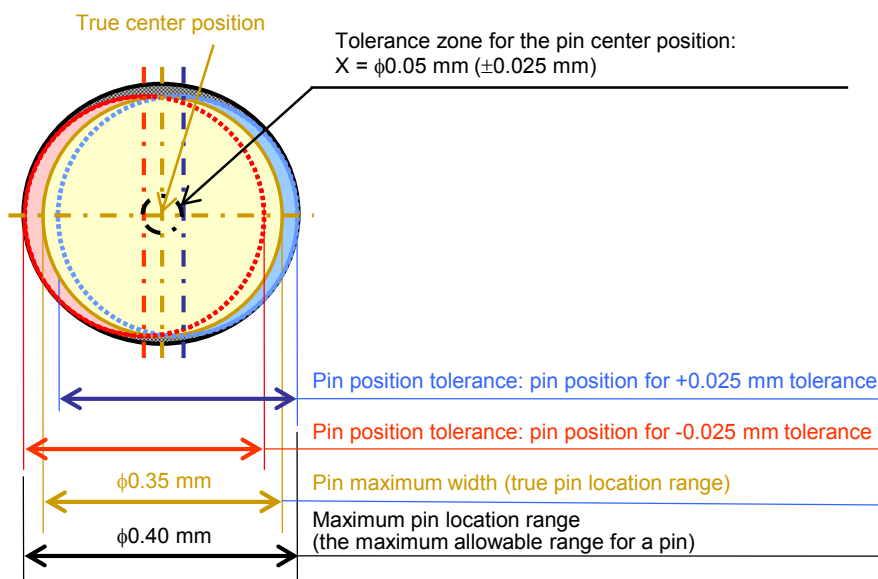


Figure 2.10 Pin Center Position Tolerance for a 0.5 mm Pitch BGA

2.2.2 Mounting Pad Design for BGA and LGA Packages

There are two types of mounting pad differentiated by their structure: NSMD (non-solder mask defined) and SMD (solder mask defined). These have the corresponding characteristics listed below. The type should be determined according to the needs of the application based on these characteristics.

NSMD characteristics:

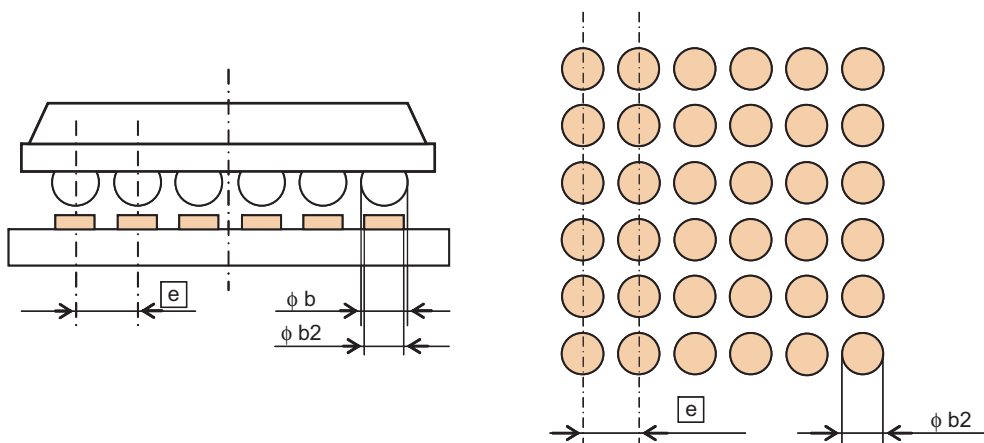
- Since the solder joint strength is greater than that for the SMD type, these joints have a longer thermal cycle lifetime.
- It is easier for pad peeling or open circuits at the pad neck necks to occur due to mechanical stresses.

SMD characteristics:

- Since the solder joint strength is lower than that for the NSMD type, these joints have a shorter thermal cycle lifetime.
- It is harder for pad peeling or open circuits at the pad neck necks to occur due to mechanical stresses.

Note: The characteristics above apply when the land dimensions on the package and mounting pad dimensions on the printed wiring board are the same.

2.2.3 Mounting Pad Dimensions (Design Range)



• Renesas Package dimension Example (Design Range)

Pin pitch (mm)	1.50	1.27	1.00	0.80	0.75	0.65	0.50	0.40
Pad dimensions b2 φ (mm)	0.55 to 0.65	0.55 to 0.65	0.45 to 0.55	0.35 to 0.45	0.35 to 0.45	0.30 to 0.40	0.20 to 0.30	0.15 to 0.25

Figure 2.11 BGA and LGA Examples

Since the stress after solder mounting is distributed evenly at the solder joint, it is commonly said that it is acceptable to design the mounting pad dimensions to have the same dimensions as the diameter of the lands on the package (BGA and LGA).

Contact your Renesas sales representative for details on the package land dimensions.

2.3 THDs

For THD packages, the approach is basically the same as that for SMD packages. However, since THD devices are held in a chuck and the leads inserted in through holes (TH) provided in the printed wiring board, it is necessary to take the dimensions in the thickness direction as well as the lead width direction into account. Thus there are some differences as compared to SMD mounting.

Here we describe a design example for the pin location range and pin through hole diameter based on the package drawing for an 8-pin plastic DIP (7.62 mm (300 mil)).

2.3.1 THD Pin Location Range

Figure 2.12 shows the package drawing for a 7.62 mm (300 mil) pitch 8-pin plastic DIP.

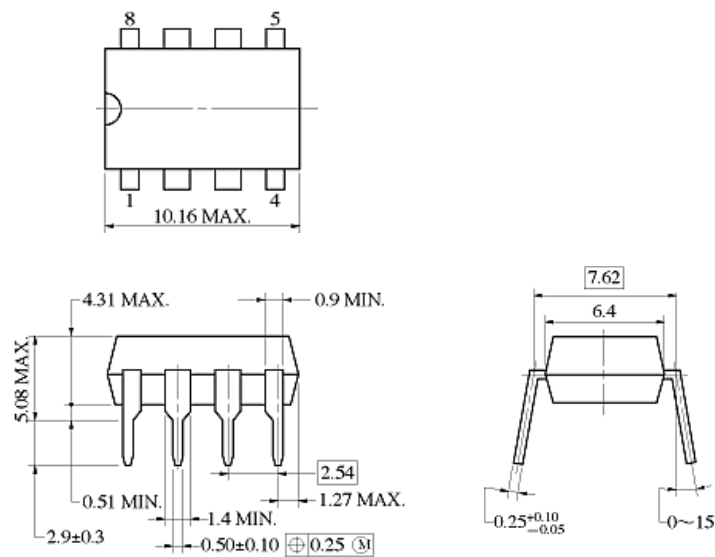


Figure 2.12 Package Drawing of 8-Pin Plastic DIP (7.62 mm (300 mil))

The pin location range must be within a range determined from the pin array spacing $e = 2.54$ mm, the pin row spacing $e_1 = 7.62$ mm, the maximum value of the pin width, and the pin positional tolerance $x = 0.25$ mm. The tolerance for the pin center position is a particularly important value in designing the pin location range as listed in table 2.1.

- Pin pitch $e = 2.54$
- Pin width $b = 0.50 \pm 0.10$
- Pin row spacing $e_1 = 7.62$
- Pin thickness $c = 0.25 +0.10/-0.05$
- Pin center position tolerance = $\oplus \phi 0.25 \textcircled{M}$

Table 2.1 Pin Center Position Tolerance

\oplus	Symbol indicating the positional tolerance.
0.25	Numerical value indicating that the positional tolerance of the pin center is in the range of $x = 0.25$ mm. Allowable range that each pin center can deviate from the logically accurate dimensions when parallel chucking is performed at a pin row interval of $e_1 = 7.62$ mm for both pin rows of the DIP package.
\textcircled{M}	Symbol indicating that the positional tolerance can be up to $x = 0.25$ mm, based on a pin width of $b \text{ MAX} = 0.60$ mm.(i.e. If the pin width b is less than the maximum value, the tolerance will be greater than $x = 0.25$ mm)

$$\begin{aligned} \text{Location range in the pin width direction} &= 2x [b \text{ MAX.}/2 + x/2] = 2 \times [(0.50 + 0.1)/2 + 0.25/2] \\ &= 2x [0.85/2] = 0.85 \text{ mm} \end{aligned}$$

$$\begin{aligned} \text{Location range in the pin thickness direction} &= 2x [c \text{ MAX.}/2 + x/2] = 2 \times [(0.25 + 0.1)/2 + 0.25/2] \\ &= 2x [0.60/2] = 0.60 \text{ mm} \end{aligned}$$

From the results of these calculations, the location range in the pin width direction is included in the location range in the pin thickness direction.

Figure 2.13 shows the location range in the pin width direction.

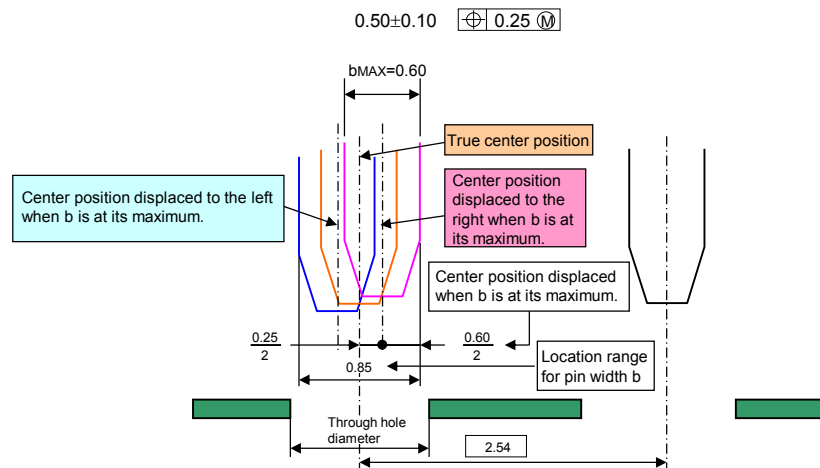


Figure 2.13 Relationship Between Center Position Displacement in the Pin Width Direction and Printed Wiring Board Through Holes

2.3.2 Through Hole Diameter Design

The through hole diameter is designed based on the pin location range for the THD. Through holes on printed wiring boards are circular in shape and furthermore, since the pin thickness has a tolerance, the through hole diameter must be designed to be larger by that amount.

This relationship is shown in figure 2.14, and the radius of the holes in the printed wiring board that takes the pin thickness into account can be calculated as shown below.

$$r = \sqrt{(x/2 + bMAX./2)^2 + (cMAX./2)^2}$$

$$= \sqrt{(0.25/2 + 0.60/2)^2 + (0.35/2)^2}$$

$$= 0.46 \text{ (mm)}$$

Therefore, the diameter of through holes in the printed wiring board is given by $\phi = 2 \times r = 2 \times 0.46 = 0.92 \text{ mm}$.

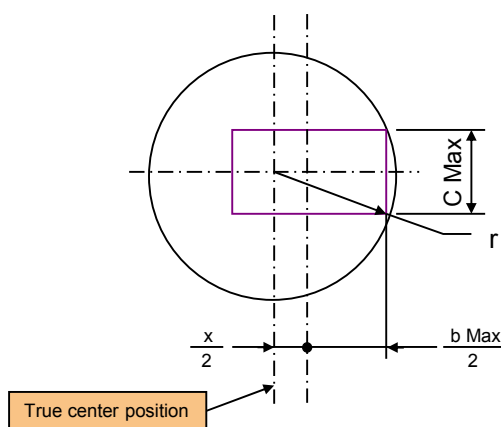


Figure 2.14 Relationship Between the Pin Position Displacement Considering Pin Thickness and the Printed Wiring Board Through Hole Diameter

If the through hole diameter on the printed wiring board is at least 0.92 mm, then the pins can be inserted without problem.

The ends of pins on DIP packages usually have a tapered shape with a taper ratio of 0.2/0.5. Therefore, printed wiring boards with through holes with a diameter smaller than 0.92 mm, namely 0.8 mm (minimum), are used.

Defective soldering may occur during flow mounting or other processes if the through hole diameter is too large. When designing actual mounting pads, a comprehensive review is required for all soldering conditions, including the desired pin joint strength, package/printed wiring board precision, mechanical precision of equipment in which the board will be used, and the performance of the soldering equipment.

2.3.3 Through Hole Diameter Dimensional Design for Printed Wiring Boards (Design Ranges)

Table 2.2 Through Hole Diameter Examples

Pin row spacing e_1 (mil)	300	400	600	750
Through hole diameter ϕ (inner dimension) (mm)	0.85 to 0.92	0.81 to 0.85	0.85	0.85

Note: The pin spacing e_1 is a fixed 1.778 mm.

2.4 Discrete Devices

For mount pad dimension of discrete devices, visit the discrete packages list on our web site at http://www.renesas.com/products/package/information/discrete_name_list/index.jsp

2.5 Board Materials

Board materials can be classified into two types: printed wiring board based on epoxy resins and thick film circuit substrates (ceramic substrates) that are based on alumina ceramics. The printed wiring boards used widely in consumer and industrial equipment can be classified into three types according to the purpose of the board, as listed in table 2.3.

Table 2.3 Examples of Substrate Materials

Type		Composition			Features	Applications
		Resin	Board Material	Conductor		
Printed wiring boards	Paper phenol (FR-2) boards	Phenol	Paper	Copper foil	Low cost, ease of mass production	Consumer electronic equipment
	Paper epoxy (FR-3) boards	Epoxy	Paper	Copper foil	A board intermediate between paper phenol and glass epoxy	Audio equipment
	Glass epoxy (FR-4) boards	Epoxy	Glass cloth	Copper foil	Superlative in electrical characteristics, resistance to moisture, and dimensional stability	<ul style="list-style-type: none"> Consumer electronic equipment Industrial electronic equipment
	Glass epoxy (FR-4) boards (halogen free)	Epoxy (halogen free)	Glass cloth	Copper foil	Environmental considerations More highly elastic than ordinary FR-4 (minimal warping and flexing) Higher heat resistance than ordinary FR-4	<ul style="list-style-type: none"> Consumer electronic equipment Industrial electronic equipment
	Heat-resistant glass epoxy (FR-5 equivalent) boards	Heat-resistant epoxy	Glass cloth	Copper foil	<ul style="list-style-type: none"> High Tg and good reliability. A low-cost type of glass polyimide. 	<ul style="list-style-type: none"> COB (chip on board) Thin form-factor applications
Flexible boards		Polyimide		Copper foil	Can be freely bent	Cameras, calculators, and similar products
Ceramic substrates		Alumina ceramic		Ag-Pd	<ul style="list-style-type: none"> High heat resistance and high thermal conductance. Superb reliability. 	Electronic equipment for automotive applications

When designing a board, while the board materials must be selected based on electrical characteristics, thermal dissipation, and similar properties, designers must also analyze the aspects discussed in sections 2.5.1 to 2.5.3.

2.5.1 Preventing Mounting Pad Oxidation

The conductor used to form the mounting pads on printed wiring boards is a copper foil and surface oxidation can be promoted by storage conditions or the soldering temperature. This can result in a degradation of the solderability of the mounting pads.

While the processing methods listed in table 2.4 can be used to prevent this surface oxidation, since each of these has advantages and disadvantages, the method used must be selected according to the application at hand.

For example, when mounting fine pitch packages for ordinary applications, Ni/Au is commonly used as a preflux for cell phone and similar applications.

If a preflux is used, an appropriate one of the many types available must be chosen for the application.

Also, when solder surface processing is required for fine-pitch mounting pads, it is thought that solder plating in which the solder thickness on the surface is even (has good flatness) makes it harder for positional displacements to occur in solder printing and mounting.

Since the mounting pad surface processing affects ease of mounting and reliability as described above, we strongly recommend thorough evaluation when adopting these methods.

Table 2.4 Mounting Pad Surface Oxidation Prevention Processing

Surface Processing Method		Strengths	Weaknesses
Solder leveler		<ul style="list-style-type: none"> There is no exposure of copper surfaces Long storage periods 	<ul style="list-style-type: none"> The amount of solder supplied during solder printing is unstable. Since the leveler and paste are not compatible, the solderability is variable.
Preflux	Rosin	<ul style="list-style-type: none"> Surface processing costs are lower than with metallic surface processing (solder leveler, gold plating). Good solderability 	<ul style="list-style-type: none"> Rosin-based fluxes include VOCs (volatile solvents) Since the preflux is applied to the whole board, foreign matter can adhere to the board surface. Storage periods are shorter
	Water soluble	<ul style="list-style-type: none"> Does not include VOCs (volatile solvents) Surface processing costs are lower than with metallic surface processing (solder leveler, gold plating). Since the preflux is only applied to the land surfaces, it is harder for foreign matter to adhere to the board surface. Good solderability 	Storage periods are shorter
Ni/Au flashing		<ul style="list-style-type: none"> Good heat resistance Good solderability Long storage periods 	<ul style="list-style-type: none"> High costs Mounting reliability can be degraded by due to the thickness of the gold plating.

2.5.2 Printed Wiring Board Warping

Mounting problems that were thought to be due to warping of printed wiring board and packages during reflow have now been verified. (See section 5, Examples of Solder Mounting and Mounting Problems.) In addition to changing the type of board used or its thickness, the following workarounds should also be considered if there is significant warping of the printed wiring boards and problems that could be caused by that are of concern.

- Equalize the ratio occupied by conductor on the printed wiring board surfaces.
- For double-sided mounting, analyze the placement of components and minimize the difference in coefficients of thermal expansion of the front and back sides of the board.
- Provide a warping prevention structure during reflow (during cooling).
- Use a printed wiring board clamping jig and forcibly prevent warping while performing reflow soldering.
- Use a heat-resistant glass epoxy board.

Since the type and thickness of the board used influences board warping, we recommend carefully analyzing the board specifications, including consulting with the board manufacturer, and thoroughly checking all aspects based on this evaluation.

2.5.3 Solder Joint Reliability

Minimizing the difference in coefficients of thermal expansion between the printed wiring board and the packages used must be considered to assure solder joint reliability. For example, when ceramic packages are surface mounted, consider using a ceramic board with an essentially identical coefficient of thermal expansion.

Also, when mounting miniature thin packages in which the ratio of the area occupied by the silicon chip itself is high (such as the TSOP, VFQN, and S-WFBGA packages), increased solder joint lifetimes can be expected if you select a board with a coefficient of thermal expansion that is as close to that of the package as possible to reduce the apparent coefficient of thermal expansion of the packages overall. Such boards include FR-5 equivalent boards that have a high glass transition temperature (T_g) and a small coefficient of thermal expansion.

3. Mounting Processes

3.1 Solder Supply Processes

3.1.1 Solder Paste

(1) Material Structure

The main components of solder paste are solder powder and flux. The amount of solder powder contained in solder paste is generally in the 80 to 95 weight % range. The amount contained influences both the viscosity of the paste and the thickness of the solder after reflow. The following sections discuss the solder powder and the flux.

a. Solder powder

Previously, the metallic structure of solder powder consisted of a variety of alloys, mainly in the Sn-Pb family and the Sn-Pb-Ag family, such as eutectic solder (Sn-37Pb) and solder with added silver, such as the Sn-36Pb-2Ag solder. However in recent years, a variety of lead-free metallic compositions (mainly in the Sn-Ag-Cu family) have come to be widely used to completely eliminate lead for environmental reasons. The particular lead-free alloy used is chosen according to the application and soldering method used.

Solder powder has a range of power particle sizes as shown in figure 3.1, and this range affects the printing characteristics of the solder paste. Note that solder powder with spherical shape should be used for mounting packages with a fine pin pitch.

While solder powders with a particle diameter of 50 to 60 μm or smaller are commonly used, better results can be obtained for fine pitch packages (such as 0.5 mm or finer pitch QFP and 0.8 mm and finer pitch BGA packages) by using a material with a fine particle size of 40 μm or smaller and a narrow viscosity distribution. Note, however, that there is concern that, with solder powders with finer particle sizes, capillary ball formation due to surface oxidation may occur and that solder wettability may be affected. This means that special care is required when using this type of solder powder.

b. Flux

Flux is used for the following reasons in soldering processes.

- Removal of oxidized matter from components and pattern surfaces.
- Preventing reoxidation during soldering
- Reducing the surface tension of the molten solder

That is, it is used to improve solderability.

The four components of the fluxes used to assist soldering are tackifiers, thixotropic agents, solvents, and activating agents. These are used for the following purposes.

- Tackifier resins: Component mountability, metal cleaning, reoxidation prevention
- Thixotropic agents: Preventing separation of solder powder and flux, and droop prevention
- Activating agents: Metal cleaning
- Solvents: Forming the paste

There are three main types of flux: rosin fluxes, alloy resin fluxes, and water soluble fluxes. In addition, rosin fluxes are classified into three types by their degree of activation: R (non-activated Rosin), RMA (Rosin Mildly Activated), and RA (Rosin Activated). Table 3.1 lists their features.

Table 3.1 Flux Types and Features

Flux Type	Features
Type R, ROL Type (non-activated Rosin , Rosin Low activity levels)	These are non-activated fluxes. They are noncorrosive.
Type RMA, ROM Type (Rosin Mildly Activated , Rosin Moderate activity levels)	These are weakly activated fluxes. They are noncorrosive. They provide superior solderability compared to type R fluxes.
Type RA, ROH Type (Rosin Activated , Rosin High activity levels)	These are strongly activated fluxes. While they provide superior solderability compared to type R and RMA fluxes, they are more strongly corrosive.

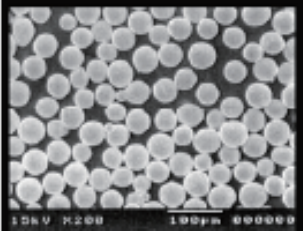
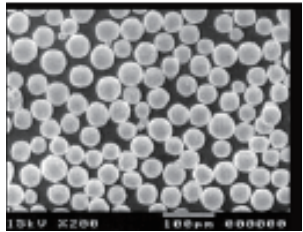
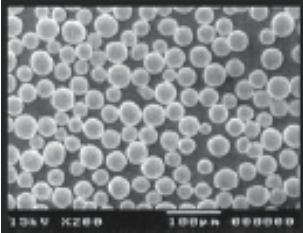
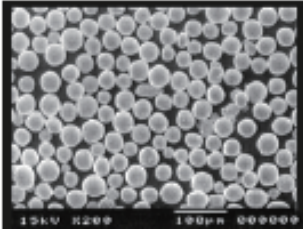
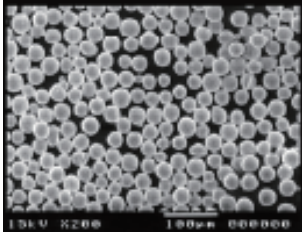
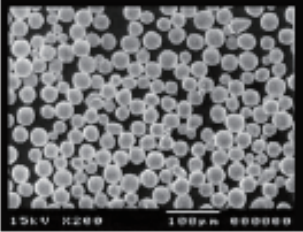
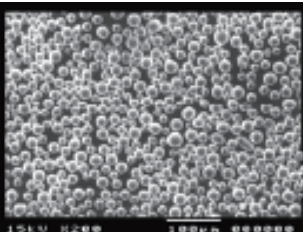
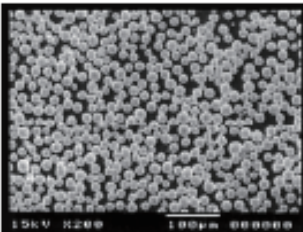
Solder Powder Size Range	Sn-3Ag-0.5Cu Solder Powder	Sn-37Pb Solder Powder
Type 2 0.075 mm to 0.045mm		
Type 3 0.045 mm to 0.020mm		
Type 4 0.038 mm to 0.020mm		
Type 5 0.025 mm to 0.010mm		

Figure 3.1 SEM Photographs of Solder Particles in Solder Paste

Table 3.2 Solder Powder Size for Solder Paste and Corresponding Lead Pitches

- Lead type packages: QFP, SOP, and similar packages

Solder Powder Size Range	Lead Pitch (mm)					
	1.27	1.00	0.80	0.65	0.50	0.40
Type 2 0.075 to 0.045 mm	○	○	○			
Type 3 0.045 to 0.020 mm			○	○	○	
Type 4 0.038 to 0.020 mm				○	○	○
Type 5 0.025 to 0.010 mm						○

Source: Senju Metal Industry Co., Ltd.

- Bump and land type packages: BGA, LGA, and similar packages

Solder Powder Size Range	Land Pitch (mm)					
	1.27	1.00	0.80	0.65	0.50	0.40
Type 2 0.075 to 0.045 mm	○	○	○			
Type 3 0.045 to 0.020 mm			○	○		
Type 4 0.038 to 0.020 mm				○	○	
Type 5 0.025 to 0.010 mm					○	○

Source: Senju Metal Industry Co., Ltd.

(2) Required Characteristics

This section discusses the characteristics required in solder pastes.

a. Before reflow

Minimal changes with time since manufacture.

Good printability and applicability characteristics.

Minimal changes with time after application. (A long retention time for adhesion characteristics, and loss of shape does not occur.)

The solder powder must not separate from the flux.

The surface must not harden after solder paste manufacture.

Minimal droop (and bleeding).

b. After reflow

Good solderability

Minimal occurrence of capillary balls.

Good cleanability characteristics, so that no flux residues remain.

If flux residues do occur, reliability must be maintained.

(3) Notes on Selection

When selecting a solder paste, keep the following points in mind from the standpoints of printability, solder bridges and solder balls, and cleanability.

a. Printability

— Normally, a solder powder particle size of 1/4 to 1/5 or less of the metal stencil aperture is selected.

If the viscosity is too high, stencil separability is degraded and cracking/crazing can occur. If it is too low, bleeding or print drooping may occur. Generally, for printing a viscosity of from 200 to 300 Pa·s at 25°C (Malcolm solder paste viscometer) is recommended.

(The thixotropic properties of the solder paste also require care.)

Table 3.3 Solder Paste Characteristics by Applications

Application	Viscosity (Pa·s at 25°C)
Dispenser	100 to 300
Printing	200 to 300

b. Solder bridges and capillary balls

Watch out for solder powder oxidation, and select a solder powder narrow particle size distribution.

Select a solder paste with flux solvents that have a low boiling point, and select a solder paste in which the rosin has a high molecular weight and the amount of flux is the lowest possible.

c. Cleanability

Cleaning residues are thought due to reduced rosin solubility in the cleaning agents, that is caused by the rosin oxidation while the reflow process. Accordingly, select a solder paste that uses a rosin that is stable with respect to oxidation.

3.1.2 Solder Paste Printing Processes

There are two supply methods for solder paste: dispenser supply and printing.

Usually, printing is selected for its mass production efficiency. Therefore we will only discuss printing in this section.

(1) Printing precision

Printing equipment with image recognition functions is used for solder printing for fin pitch devices (e.g. 0.5 mm and finer pitch QFP and 0.8 mm and finer pitch BGA packages).

Note that the printing precision of current printing equipment with image recognition functions is ± 0.025 to ± 0.05 mm.

(2) Printed form (of the solder)

Factors that can influence the printed form include the type of the stencil, the surface shape and surface processing on the mounting pads of printed wiring board, the printer settings and conditions, and the solder paste used. In the following, however, we discuss the type of the stencil used and the printer settings and conditions, which are particularly influential on the printed form.

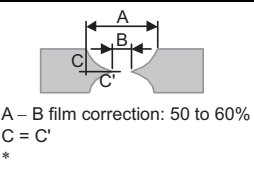



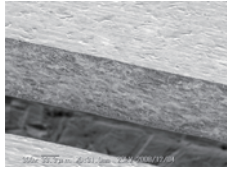
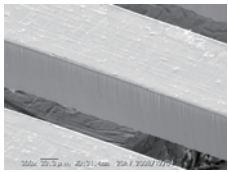
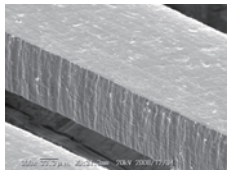
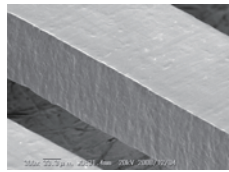
a) Stencil types

As package lead spacings become finer and finer, the cross stencil form of the stencil apertures has come to have a large influence on the acceptability of the printing due to the smaller and smaller sizes of the apertures.

The stencil, which was previously formed by an etching process, is made to have a shape curved in the thickness direction in forming. As a result, solder paste remains in these curved sections during printing, and as the number of boards printed increases, this remaining paste matter can cause clogging of the apertures. This can cause thin areas, and the solder paste may work its way around to the back side of the stencil (the side that contacts the printed wiring board) during print and cause bleeding and smearing.

To improve these problems, stencil with improved etching precision and stencil produced by new methods are now being sold. Table 3.4 compares the etching manufacturing method with the additive and laser manufacturing methods, which are new methods.

Table 3.4 Stencil Manufacturing Method Comparison

Method	Etching	Additive	Laser	Laser + Special Processing
Material	Stainless steel, copper, phosphor bronze	Nickel	Stainless steel	Stainless steel
Cross section shape	 <p>A - B film correction: 50 to 60% C = C' *</p>			
Aperture photographs				

Source: Bon Mark Co., Ltd.

Note: * There are differences in the etching precision depending on the stencil maker.

We recommend looking into the use of either additive or laser methods if you are considering solder printing of fine pitch patterns.

b) Printer Settings and Conditions

In this section, we discuss five items ((1) though (5) below) that influence printability.

(1) Squeegee

Squeegees have an elastic blade made from rubber, in particular, polyurethane rubber is widely used. The hardness of the rubber is an important condition; a hardness in the range 60 to 90 degrees is appropriate.

There are three cross sectional shapes used for the tip of the polyurethane squeegees described above: flat, angled, and acute. These are each used for different printing applications.

More recently, metal squeegees that are resistant to wear and have superlative stability in the amount of solder applied have become available commercially.

During printing, it is desirable to reduce the squeegee tip pressure and print at a low speed. In this case, a phenomenon called rolling, in which the solder paste is rolled in, can be observed.

(2) Printing gap (separation between the printed wiring board and the stencil)

If the printing gap is too small, bleeding can occur, and if too large, problems such as variations in the form of the printed solder and scattering of solder when separating the work may occur. Therefore an appropriate gap must be set.

More recently, contact printing technology, in which this printing gap is set to 0 mm appears ready for more widespread adoption. However, adoption of contact printing requires the use of printing equipment that supports low printing pressures and speed control when separating the screen from the work.

(3) Printing pressure

The actual printing pressure is generally around 5 to 10 g/cm². Note, however, that this pressure is the pressure at the tip of the squeegee and can be influenced by the way the squeegee collapses under this pressure. Care is therefore required when determining the printing pressure.

More recently, printing equipment that provides a floating squeegee structure to achieve lower and more even printing pressures have become available commercially.

(4) Squeegee speed

During printing, a squeegee speed in the range 5 to 50 mm/s is used. Note, however, that it is necessary to slow the squeegee speed as much as possible so that the solder paste rolling occurs.

(5) Screen removal speed

The shear elastic force that occurs between the solder paste and the stencil after printing at screen separation can be suppressed by controlling the speed of screen removal, and the solder paste's ease of screen removal characteristics can be improved. We think that the necessity of applying this technology will continue to increase in the future to support ever finer package pin spacings.

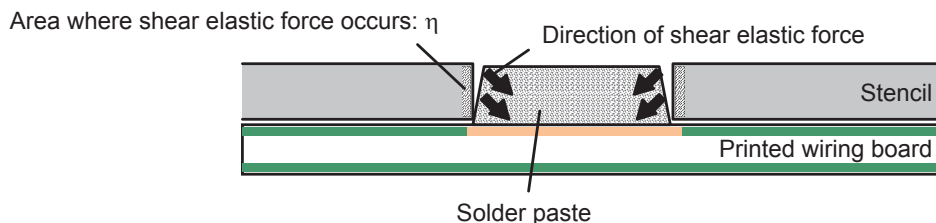


Figure 3.2 Shear Elastic Force Occurring Between Stencil and Solder Paste

3.1.3 Amount of Solder Paste Supplied

(1) Supply amount of solder paste that supports gull-wing mounting

After using the following simplified method for working out the amount of solder paste required considering the optimal shape of the solder after reflow, calculate the required amount precisely.

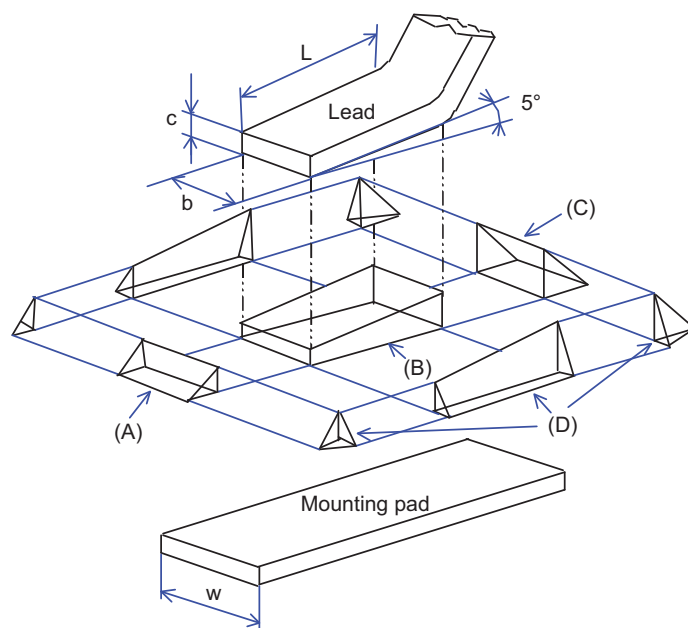


Figure 3.3 Exploded Block Diagram of the Soldered Sections

The optimal solder amount can be determined by calculating the solder volume for each block in the exploded block diagram of the soldered sections shown in figure 3.3.

A to D: Amount of solder in all blocks (optimal solder amount) = A + B + C + 2D

Next, the required amount of solder paste can be determined from the following formula.

Required amount of solder paste (A × t) = optimal solder amount × ($\omega_1/\rho_1 + \omega_2/\rho_2$) / (ω_1/ρ_1)

Here,

A = Stencil aperture area

t = Solder paste printing thickness

ω_1 = Solder weight percent in the solder paste

ρ_1 = Specific gravity of the solder

ω_2 = Flux weight percent in the solder paste

ρ_2 = Specific gravity of the solder

It will be necessary to analyze the aperture dimensions and metal thickness of the stencil used for solder printing based on the result of the above calculations for the required amount of solder paste.

(2) Solder paste supply amounts for BGA/LGA printing

Take the following items into account when setting the solder paste supply amount.

a) Solder paste printing thickness

In setting the solder paste printing thickness, consider the planarity of the package pins and investigate the minimum solder paste printing thickness as follows.

Minimum solder paste printing thickness = Package pin planarity + 0 to 30 μm

b) Solder paste printing diameter

In setting the solder paste printing diameter, take the following items into consideration.

- The stencil design target is same as a mount pad size.
- To prevent open solder connections, set the solder paste printing diameter to be a value larger than the minimum solder paste printing thickness as stipulated above in section a), Solder paste printing thickness.

(3) Mounting Evaluation Data for Representative Packages

This section presents the results of mountability evaluations performed for representative packages with solder paste printing thickness and printing diameter as parameters.

Solder Paste Supply Amount vs. Mountability [P-VQFN]

This section presents an example of evaluation of solder paste supply amount and mountability for the P-VQFN package.

[Evaluation Sample]

Package Dimension	Mounting Pads	Stencil (0.10 mm thickness)	Solder Paste	Lead Plating
P-VQFN48-7x7-0.5	0.75 × 0.25 mm	0.75 × 0.25 mm	Sn-3Ag-0.5Cu	Sn-Bi

[Mounting Conditions]

Package Dimension	Placement Load*	The Push Distance at Placement	Reflow Temperature
P-VQFN48-7x7-0.5	300 g/ic	0.20 mm	250°C (Air reflow)

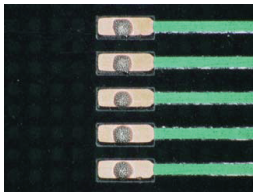

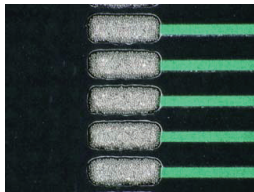
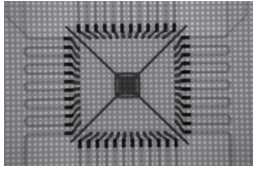
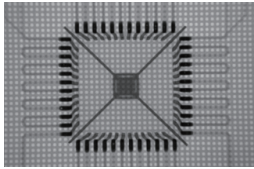
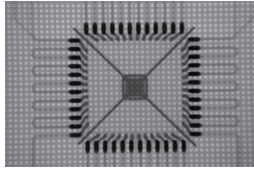
Note: * The placement load shows spring loading for the mounting nozzles on the SMD placement system.

[Mounting Results]

Solder Printing (stencil aperture)	0.20 × 0.20 mm	0.25 × 0.35 mm	0.25 × 0.55 mm	0.25 × 0.75 mm	0.25 × 0.95 mm
Mounting Results (opens and shorts)	0/10	0/10	0/10	0/10	0/10

Solder Printing (stencil aperture)	0.30 × 0.30 mm	0.30 × 0.35 mm	0.30 × 0.55 mm	0.30 × 0.75 mm	0.30 × 0.95 mm
Mounting Results (opens and shorts)	0/10	0/10	0/10	0/10	0/10

[Visual Examples]

	Solder Printing (Stencil Aperture) Dimensions		
	0.20 × 0.20 mm	0.25 × 0.75 mm	0.30 × 0.95 mm
Solder printing appearance			
Post-reflow X-ray inspection			

For the P-VQFN package, no opens or shorts were recognized with solder stencil apertures from 0.20 × 0.20 mm to 0.30 × 0.95 mm. Since the P-VQFN package is difficult to inspect visually, we recommend that printing conditions be set based on X-ray, peel-off, or other inspections to determine the mounting conditions.

Solder Paste Supply Amount vs. Mountability [240 pin FBGA]

This section presents an example of evaluation of solder paste supply amount and mountability for the FBGA package.

[Evaluation Sample]

Package Dimension	Mounting Pads	Stencil (0.10 mm thickness)	Solder Paste	Ball
P-FBGA240-15x15-0.8	φ0.4 mm	φ0.3 to φ0.6 mm	Sn-3Ag-0.5Cu	Sn-3Ag-0.5Cu

[Mounting Conditions]

Package Dimension	Placement Load*1	The Push Distance at Placement	Reflow Temperature
P-FBGA240-15x15-0.8	300 g/ic	0.20 mm	240°C (Air reflow)

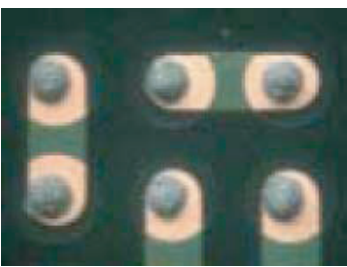

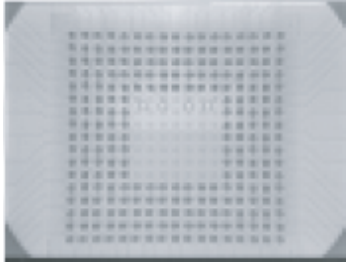
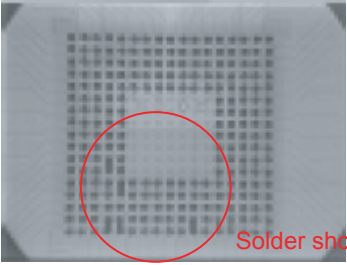
Note: 1. The placement load shows spring loading for the mounting nozzles on the SMD placement system.

[Mounting Results]

Solder Materials	Stencil Aperture Dimensions			
	φ0.3 mm	φ0.4 mm	φ0.5 mm	φ0.6 mm
Sn-3Ag-0.5Cu solder	0/10	0/10	0/10	4/10*2

Note: 2. Solder short

[Visual Examples]

	Stencil Aperture Dimensions	
	φ0.3 mm	φ0.6 mm
Solder printing appearance		
Post-reflow X-ray inspection		

For the FBGA (0.8 mm pitch) package, no opens or shorts were recognized with stencil apertures from φ0.30 mm to 0.50 mm. Since the FBGA package is difficult to inspect visually, we recommend that printing conditions be set based on X-ray, peel-off, or other inspections to determine the mounting conditions.

Solder Paste Supply Amount vs. Mountability [LGA]

This section presents an example of evaluation of solder paste supply amount and mountability for the LGA package.

[Evaluation Sample]

Package Dimension	Mounting Pads	Stencil (0.10 mm thickness)	Solder Paste	Lead Plating
LFLGA336-14x14-0.65	φ0.35 mm	φ0.35 mm	Sn-3Ag-0.5Cu	Ni/Au
LFLGA304-13x13-0.5	φ0.30 mm	φ0.35 mm	Sn-3Ag-0.5Cu	Ni/Au

[Mounting Conditions]

Package Dimension	Placement Load*	The Push Distance at Placement	Reflow Temperature
LFLGA336-14x14-0.65	180 g/ic	0.20 mm	250°C (Air reflow)
LFLGA304-13x13-0.5			

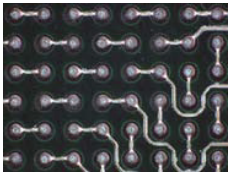
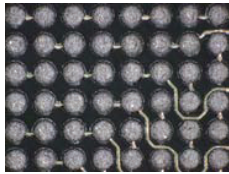
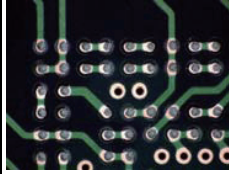
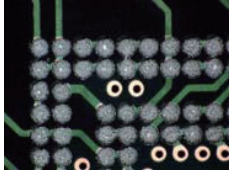
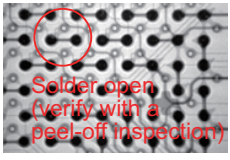
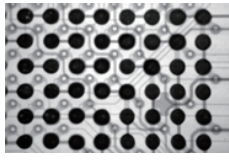
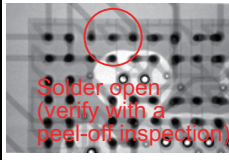
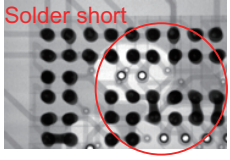
Note: * The placement load shows spring loading for the mounting nozzles on the SMD placement system.

[Mounting Results]

	Stencil Aperture Dimensions					
	φ0.20 mm	φ0.25 mm	φ0.30 mm	φ0.35 mm	φ0.40 mm	φ0.45 mm
LFLGA336-14x14-0.65	—	2/10* ¹	0/10	0/10	0/10	0/10
LFLGA304-13x13-0.5	6/8* ¹	0/8	0/8	0/8	3/8* ²	—

Notes: 1. Solder open
2. Solder short

[Visual Examples]

Stencil Aperture		LFLGA336-14x14-0.65 (0.65 mm pitch)		LFLGA304-13x13-0.5 (0.5 mm pitch)	
		φ0.25 mm	φ0.45 mm	φ0.20 mm	φ0.40 mm
Solder printing displacement: 0.15 mm	Solder printing				
	Post-reflow X-ray				

For the LGA (0.65 mm pitch) package, no opens or shorts were recognized with stencil apertures from φ0.30 mm to 0.45 mm.

For the LGA (0.5 mm pitch) package, no opens or shorts were recognized with stencil apertures from φ0.25 mm to 0.35 mm. Since the LGA package is difficult to inspect visually, we recommend that printing conditions be set based on X-ray, peel-off, or other inspections to determine the mounting conditions.

3.2 Component Mounting Processes

3.2.1 Adhesives

In flow soldering processes, the SMD packages are usually attached to the printed wiring board with an adhesive.

The following characteristics must be taken into account when selecting an adhesive.

1. Select an adhesive with an adequate adhesive strength
2. Use an appropriate amount of adhesive to prevent both soldering failures and inadequate adhesion. In particular, each component's standoff distance and weight must be considered.
3. The hardening temperature must fall within the storage temperature ranges in the ratings for each of the components. In particular, a temperature lower than the glass transition temperature (around 150°C) that some plastic packages have.

3.2.2 Component Placement Equipment

One critical point in the component placement process is the precision with which the mounted components to be mounted are placed. Verify the amount of margin for displacement is provided by the component self-aligning effect. A mounting precision that falls within that range is required.

In particular, high-precision placement equipment is required for fine pitch packages with a lead pitch of 0.5 mm or under.

Table 3.5 lists the features of the different types of component placement equipment.

Table 3.5 Component Placement Equipment Features

Item	Type		
	High-Speed Type	Multifunction Type	
Tact time	Chip components: 0.1 to 0.15 seconds	Chip components	0.3 to 0.6 seconds
		QFP and similar packages	0.9 to 4.0 seconds
Precision	Chip components: ± 0.1 to 0.15 mm	Chip components	± 0.05 to 0.15 mm
		QFP and similar packages	± 0.05 to 0.10 mm
Component forms	Tape components only	Tray, tape, tube	
Precision	Mechanical centering, image recognition	Chip components	Image recognition
		QFP and similar packages	Image recognition

The five items listed below are the important points when selecting this equipment.

- Price that is commensurate with the performance (mounting precision and speed)
- Support for multi-product/low-volume production
- Understanding the basic performance (positioning, repeatability, resolution)
- Connection with upstream and downstream equipment (electrical and mechanical)
- The manufacturer's service system

The following three points are particularly important when selecting equipment for mounting packages such as TSOP and QFP that either have a fine pitch of 0.5 mm or under, or packages such as BGA and LGA that have a pin arrangement with an area array form.

- The equipment must be able to recognize the printed wiring board pattern and must be able to recognize packages (the ability to recognize the electrodes area array pin electrodes for packages such as BGA and LGA).
- The equipment mounting precision must be ± 0.1 mm or better. (For 0.4 mm and narrower lead pitches, ± 0.05 mm is required.)
- Z axis (the direction of the component thickness) control must be possible.

There are now many companies that manufacture component mounting equipment, and the functions provided by each manufacturer's equipment differs somewhat.

In particular, for the image recognition method used to recognize components, there is now a trend of switching from separate recognition of the lead areas to recognizing all leads in a single operation to reduce the recognition time.

As we have stressed in the above, selection of the component mounting equipment used in the component mounting process is extremely important, and we strongly recommend you acquire as much information as possible from the equipment manufacturers when selecting the equipment.

3.2.3 Self-Alignment Effect

There is an effect, called the self-alignment effect, in which even if the positioning precision of the mounted package pins and the mounting pads on the printed wiring board is poor, the position is automatically corrected during reflow. The self alignment strength of the different mounted components can be determined using the following equation. Whether or not a self-alignment effect can be acquired can be inferred by comparing the self alignment strength and the weight of the component itself.

Self alignment strength = $\gamma \times L \times n$

γ : Surface tension of the solder

L: Contact length of a package pin and the solder (circumference)

n: Number of pins

Note: The solder surface tension for Sn-3Ag-0.5Cu solder is 558 mN/m

For reference purposes, in the following pages we introduce the results of evaluating representative Renesas packages for this self-alignment effect.

Self Alignment [TSOP] (type I)

This section presents a sample evaluation for the self-alignment effect for the TSOP (type I) package.

[Evaluation Sample]

Package Dimension	Mounting Pads	Stencil (0.10 mm thickness)	Solder Paste	Lead Plating
P-TSOP(1)48-12x18.4-0.50	0.90 × 0.20 mm	0.90 × 0.20 mm	Sn-37Pb Sn-3Ag-0.5Cu	Sn-Cu

[Mounting Conditions]

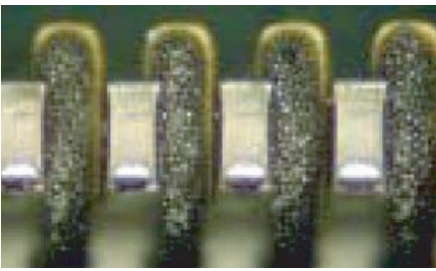
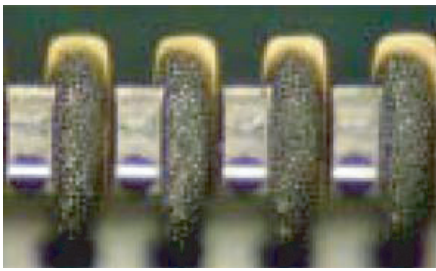

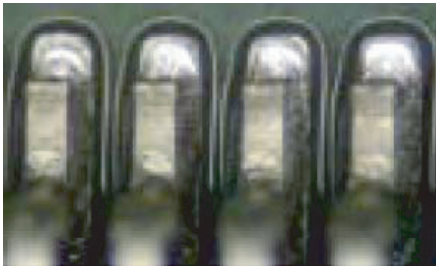
Package Dimension	Placement Load*	The Push Distance at Placement	Reflow Temperature
P-TSOP(1)48-12x18.4-0.5	300 g/ic	0.20 mm	Sn-37Pb: 220°C (Air reflow) Sn-3Ag-0.5Cu: 240°C (Air reflow)

Note: * The placement load shows spring loading for the mounting nozzles on the SMD placement system.

[Mounting Results]

Solder Materials	TSOP Displacement (protruding by 1/3)	TSOP Displacement (protruding by 1/2)	TSOP Displacement (protruding by 2/3)
Sn-37Pb solder	0/20	0/20	0/20
Sn-3Ag-0.5Cu solder	0/20	0/20	0/20

[Visual Examples]

		TSOP Displacement — Protruding by 2/3 of The Lead Width (displacement: 0.1 mm)	
		Sn-Pb Solder: 220°C (air reflow)	Sn-Ag-Cu Solder: 240°C (air reflow)
Before reflow			
			

We were able to verify self alignment for the TSOP (type I) package, even in the example where the device protruded by 2/3 of the lead width (mounting displacement: 0.1 mm).

After verifying the solder materials and reflow conditions actually used, the mounting conditions should be analyzed carefully.

Self Alignment [TSOP] (type II)

This section presents a sample evaluation for the self-alignment effect for the TSOP (type II) package.

[Evaluation Sample]

Package Dimension	Mounting Pads	Stencil (0.10 mm thickness)	Solder Paste	Lead Plating
P-TSOP(2)52-8.89x10.79-0.40	0.90 × 0.20 mm	0.90 × 0.20 mm	Sn-37Pb Sn-3Ag-0.5Cu	Sn-Cu

[Mounting Conditions]





Package Dimension	Placement Load*	The Push Distance at Placement	Reflow Temperature
P-TSOP(2)52-8.89x10.79-0.40	300 g/ic	0.20 mm	Sn-37Pb: 220°C (Air reflow) Sn-3Ag-0.5Cu: 240°C (Air reflow)

Note: * The placement load shows spring loading for the mounting nozzles on the SMD placement system.

[Mounting Results]

Solder Materials	TSOP Displacement (protruding by 1/3)	TSOP Displacement (protruding by 1/2)	TSOP Displacement (protruding by 2/3)
Sn-37Pb solder	0/20	0/20	0/20
Sn-3Ag-0.5Cu solder	0/20	0/20	0/20

[Visual Examples]

		TSOP Displacement — Protruding by 2/3 of The Lead Width (displacement: 0.1 mm)	
		Sn-Pb Solder: 220°C (air reflow)	Sn-Ag-Cu Solder: 240°C (air reflow)
Before reflow			
			

We were able to verify self alignment for the TSOP (type II) package, even in the example where the device protruded by 2/3 of the lead width (mounting displacement: 0.1 mm).

After verifying the solder materials and reflow conditions actually used, the mounting conditions should be analyzed carefully.

Self Alignment [P-VQFN]

This section presents a sample evaluation for the self-alignment effect for the P-VQFN package.

[Evaluation Sample]

Package Dimension	Mounting Pads	Stencil (0.10 mm thickness)	Solder Paste	Lead Plating
P-VQFN48-7x7-0.5	0.30 × 0.75 mm	0.30 × 0.75 mm	Sn-3Ag-0.5Cu	Sn-Bi

[Mounting Conditions]

Package Dimension	Placement Load*	The Push Distance at Placement	Reflow Temperature
P-VQFN48-7x7-0.5	300 g/ic	0.20 mm	250°C (Air reflow)

Note: * The placement load shows spring loading for the mounting nozzles on the SMD placement system.

[Mounting Results]

Solder Printing Displacement (+X)	QFN Displacement (-X)							
	0.05 mm		0.08 mm		0.12 mm		0.15 mm	
	Visual	X-ray	Visual	X-ray	Visual	X-ray	Visual	X-ray
0.00 mm	0/3	0/3	0/3	0/3	0/3	0/3	0/3	0/3
0.05 mm	0/3	0/3	0/3	0/3	0/3	0/3	0/3	0/3
0.10 mm	0/3	0/3	0/3	0/3	0/3	0/3	0/3	0/3
0.15 mm	0/3	0/3	0/3	0/3	0/3	1/3*	0/3	3/3*

[Visual Examples]

		QFN Displacement: 0.00 mm		QFN Displacement: 0.15 mm	
		Visual Inspection	X-ray Inspection	Visual Inspection	X-ray Inspection
Solder printing displacement: 0.15 mm	During QFN mounting				
	Post-reflow X-ray				

While the P-VQFN package has superlative self alignment, if there are large solder printing and mounting displacements, it is possible for solder unevenness to occur even if visual inspection reveals self alignment to have succeeded. It may be necessary to verify mounting with X-ray or other inspection techniques in advance.

Self Alignment [FBGA]

This section presents a sample evaluation for the self-alignment effect for the FBGA package.

[Evaluation Sample]

Package Dimension	Mounting Pads	Stencil (0.10 mm thickness)	Solder Paste	Balls
FBGA240-15x15-0.8	φ0.40 mm	φ0.40 mm	Sn-37Pb Sn-3Ag-0.5Cu	Sn-37Pb Sn-3Ag-0.5Cu

[Mounting Conditions]

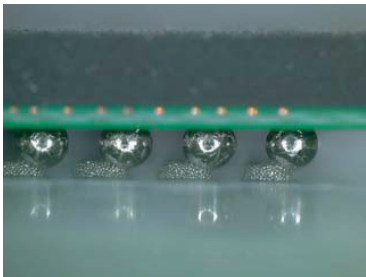
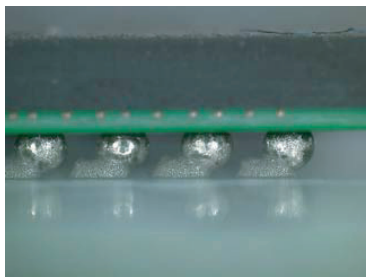
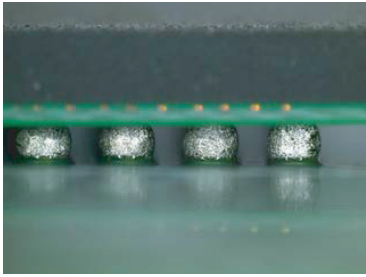
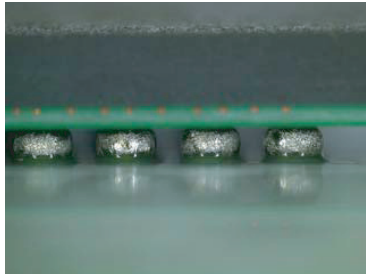
Package Dimension	Placement Load*	The Push Distance at Placement	Reflow Temperature
FBGA240-15x15-0.8	300 g/ic	0.20 mm	Sn-37Pb: 220°C (Air reflow) Sn-3Ag-0.5Cu: 240°C (Air reflow)

Note: * The placement load shows spring loading for the mounting nozzles on the SMD placement system.

[Mounting Results]

Solder Materials	Balls	FBGA Displacement: 0.1 mm	FBGA Displacement: 0.2 mm	FBGA Displacement: 0.3 mm
Sn-37Pb solder	Sn-37Pb	0/20	0/20	0/20
Sn-3Ag-0.5Cu solder	Sn-3Ag-0.5Cu	0/20	0/20	0/20

[Visual Examples]

	FBGA Displacement: 0.3 mm	
	Sn-Pb Solder: 220°C (air reflow)	Sn-Ag-Cu Solder: 240°C (air reflow)
Before reflow		
After reflow		

With FBGA packages, self alignment has been verified with a mounting displacement of up to 0.3 mm. After verifying the solder materials and reflow conditions actually used, the mounting conditions should be analyzed carefully.

Self Alignment [LGA] (0.65 mm pitch)

This section presents a sample evaluation for the self-alignment effect for the LGA (0.65 mm pitch) package.

[Evaluation Sample]

Package Dimension	Mounting Pads	Stencil (0.10 mm thickness)	Solder Paste	Terminal Plating
LFLGA336-14x14-0.65	φ035 mm	φ035 mm	Sn-3Ag-0.5Cu	Ni-Au

[Mounting Conditions]

Package Dimension	Placement Load*	The Push Distance at Placement	Reflow Temperature
LFLGA336-14x14-0.65	180 g/ic	0.20 mm	250°C (Air reflow)

Note: * The placement load shows spring loading for the mounting nozzles on the SMD placement system.

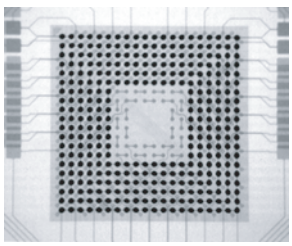
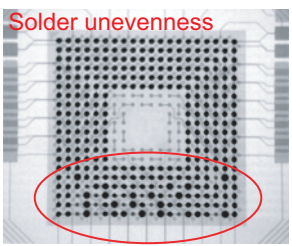
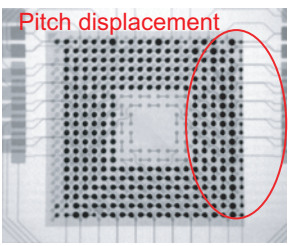
[Mounting Results]

We evaluated solder printing displacements and LGA displacements as reverse direction displacements.

Solder Printing Displacement (+X)	LGA Displacement (-X)							
	0.05 mm		0.10 mm		0.15 mm		0.20 mm	
	Visual Inspection	X-ray Inspection	Visual Inspection	X-ray Inspection	Visual Inspection	X-ray Inspection	Visual Inspection	X-ray Inspection
0.05 mm	0/3	0/3	0/3	0/3	0/3	0/3	0/3	0/3
0.10 mm	0/3	0/3	0/3	0/3	0/3	0/3	1/3	1/3*1
0.15 mm	0/3	0/3	0/3	2/3	0/3	0/3	2/3*2	2/3*2

- Notes: 1. Solder unevenness
2. Pitch displacement

[Inspection Examples (X-ray)]

	LGA Displacement: 0.2 mm		
	Solder Printing Displacement: 0.05 mm	Solder Printing Displacement: 0.10 mm	Solder Printing Displacement: 0.15 mm
Post-reflow X-ray photographs			

The result of verifying self alignment in a 0.65 mm pitch LGA package was that there were no problems if the solder printing and LGA mounting both had displacements of no more than 0.15 mm. Since it is difficult to judge soldering visually with LGA packages, it may be necessary to verify mounting with X-ray or other inspection techniques in advance.

Self Alignment [LGA] (0.5 mm pitch)

This section presents a sample evaluation for the self-alignment effect for the LGA (0.5 mm pitch) package.

[Evaluation Sample]

Package Dimension	Mounting Pads	Stencil (0.10 mm thickness)	Solder Paste	Terminal Plating
LFLGA304-13x13-0.5	φ0.3 mm	φ0.3 mm	Sn-3Ag-0.5Cu	Ni-Au

[Mounting Conditions]

Package Dimension	Placement Load*	The Push Distance at Placement	Reflow Temperature
LFLGA304-13x13-0.5	180 g/ic	0.20 mm	250°C (Air reflow)

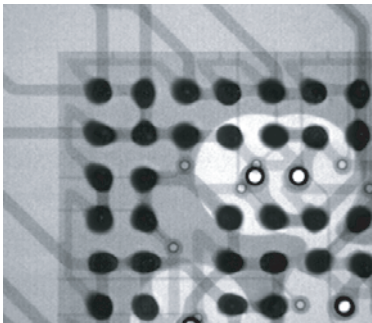
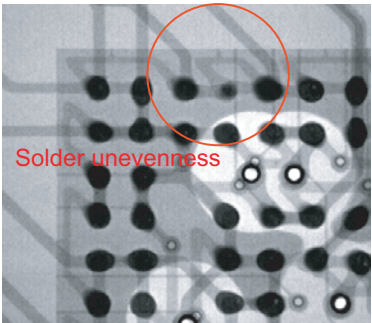
Note: * The placement load shows spring loading for the mounting nozzles on the SMD placement system.

[Mounting Results]

We evaluated solder printing displacements and LGA displacements as reverse direction displacements.

Solder Printing Displacement (+X)	LGA Displacement (-X)					
	0.05 mm		0.10 mm		0.15 mm	
0.05 mm	0/3	0/3	0/3	0/3	0/3	0/3
0.10 mm	0/3	0/3	0/3	0/3	0/3	2/3*2
0.15 mm	0/3	0/3	0/3	2/3*2	0/3	3/3*2

[Inspection Examples (X-ray)]

	LGA Displacement: 0.15 mm	
	Solder Printing Displacement: 0.05 mm	Solder Printing Displacement: 0.10 mm
Post-reflow X-ray photographs		

The result of verifying self alignment in a 0.5 mm pitch LGA package was that there were no problems if the solder printing and LGA mounting both had displacements of no more than 0.1 mm. Since it is difficult to judge soldering visually with LGA packages, it may be necessary to verify mounting with X-ray or other inspection techniques in advance.

Self Alignment [LQFP and QFP]

This section presents sample evaluations for the self-alignment effect for the LQFP and QFP packages.

[Evaluation Sample]

Package Dimension	Mounting Pads	Stencil (0.10 mm thickness)	Solder Paste	Lead plating
LQFP144-20x20-0.5	0.3 × 1.3 mm	0.25 × 1.5 mm	Sn-3Ag-0.5Cu	Sn-Bi
QFP144-20x20-0.5	0.3 × 1.3 mm	0.25 × 1.5 mm	Sn-3Ag-0.5Cu	Sn-Bi

[Mounting Conditions]

Package Dimension	Placement Load*1	The Push Distance at Placement	Reflow Temperature
LQFP144-20x20-0.5	180 g/ic	0.2 mm	240 °C
QFP144-20x20-0.5	180 g/ic	0.2 mm	240 °C

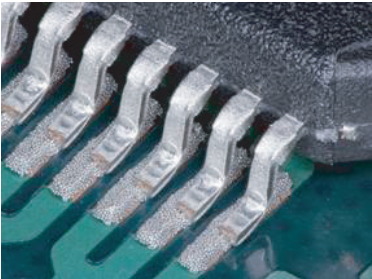
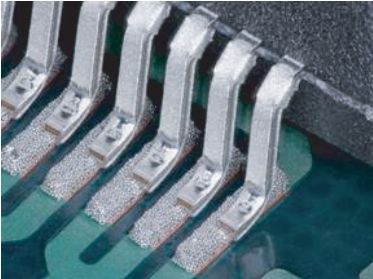

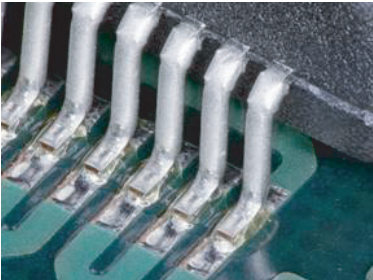
Note: 1. The placement load shows spring loading for the mounting nozzles on the SMD placement system.

[Mounting Results]

Package Dimension	Package Displacement: 0.05 mm	Package Displacement: 0.10 mm	Package Displacement: 0.15 mm*2
LQFP144-20x20-0.5	0/5	0/5	0/5
QFP144-20x20-0.5	0/5	0/5	0/5

Note: 2. The mounting displacement of 0.15 mm corresponds to a protrusion amount from the mounting pads by 1/2 the lead width.

[Self-alignment Evaluation Photograph (Example)]

	LQFP144-20x20-0.5 (Displacement: 0.15 mm)	QFP144-20x20-0.5 (Displacement: 0.15 mm)
Before reflow		
After reflow		

We verified that adequate self-alignment in reflow soldering, even for large QFP packages. After verifying the solder materials and reflow conditions actually used, the mounting conditions should be analyzed carefully.

3.3 Soldering Processes

This section describes full heating soldering processes.

The conditions required of a soldering process are that the mounted components be connected, both electrically and mechanically, to the printed wiring board. To achieve these conditions, it is necessary to meet temperature profile conditions described in a later section. A temperature profile indicates in what ways the temperature changes with time inside the soldering equipment for the printed wiring board to which the components are being attached.

3.3.1 The Temperature Profile Concept

A temperature profile must meet the following two conditions.

- The temperature setting required for soldering
Failure to meet this condition can result in problems such as poor solder wetting, solder shorting, weak solder joints, and failure to melt the solder.
- The temperature setting required to prevent diminution of component quality
Failure to meet this condition can result in problems such as package cracking and separation between chip and package.

The specific conditions settings for a temperature profile to meet the above conditions are the following.

- Peak temperature
- Solder melting time (the time the product is held at a temperature above the solder melting point)
- The preheating time and temperature
- The temperature gradient

When selecting reflow equipment, we strongly recommend looking into equipment that allows each zone to be completely isolated and the temperatures set independently as shown in figure 3.4.

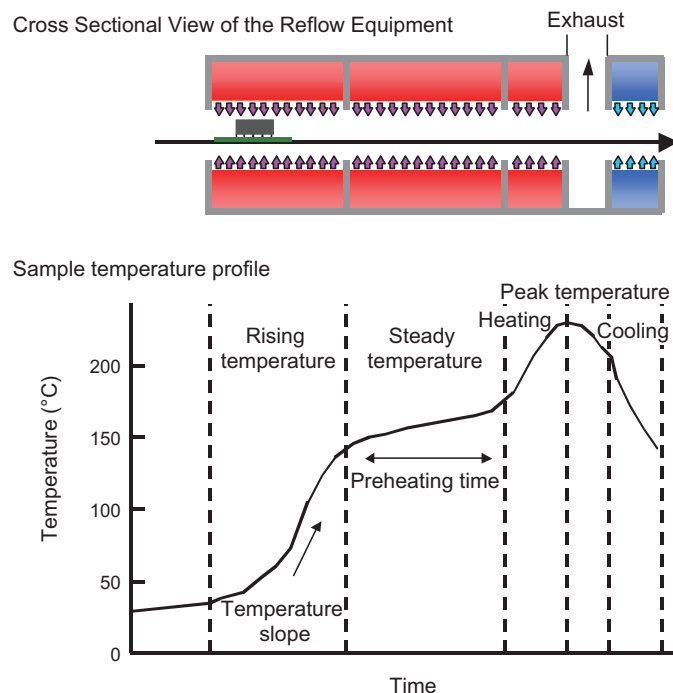


Figure 3.4 Relationship between the Reflow Equipment and the Temperature Profile

3.3.2 Temperature Profile Conditions

This section discusses the four points required of the temperature profile.

(1) Peak temperature

1. The component surface temperature must be lower than the stipulated temperature.
2. The temperature of the section being soldered must be higher than the melting point of the solder. In particular, for BGA packages, the temperature of the innermost ball (or its mounting pad on the printed wiring board), which is the place that often has the lowest temperature, must exceed the melting point of the solder paste or solder ball.
3. The peak temperature must not be excessively high.

An excessively high peak temperature can increase the warping of the printed wiring board or packages and can result in open or short circuits. The peak temperature must be set based on careful verification in advance. In particular, BGA packages are subject to greater warping than QFP packages and require special care. It is also necessary to manage the temperature of the components on the previously mounted side when mounting components on the side mounted later. If the components on the previously mounted side reach a high temperature, they may peel away due to warping. This problem also requires careful verification in advance.

When setting the peak temperature observe the following two points to set the mounting equipment temperature.

- The temperature of the soldered areas (the area under the pins or the mounting pads) must exceed the melting point of the solder. (Consider setting the peak temperature to be 20 to 40°C above the melting point of the solder.)

Notes: 1. This will be 200 to 220°C for eutectic solder (Sn-37Pb)

2. This will be 240 to 260°C for lead-free solder (Sn-3Ag-0.5Cu)

- The surface temperature of the mounted components must be lower than the stipulated temperature.

(2) Solder melting time

Solder paste consists of solder powder and a certain amount of melting time is required for the solder to wet and spread over the component contacts/leads and mounting pads on the printed wiring board after this solder powder melts and aggregates.

For mounted components with Ag-Pd contacts, however, if this solder melting time is too long, diffusion between the Ag-Pd contacts and the solder will progress and this can result in a reduction of the strength of the solder. Thus care is required here. We strongly recommend performing an evaluation of the soldering for the set solder melting time before proceeding to mass production.

Also, if components and/or printed wiring boards with high heat capacities are used, we recommend considering reflow equipment that includes a cooling structure, since the cooling rate will be slower.

Excessively long melting times (including multiple reflow operations) can lead to a degradation of solder strength in BGA packages. In particular, there have been cases where ball separation has occurred due to mechanical stress in handling in the post-mounting board process. In such cases, improvements in both the temperature profile and the mechanical stress should be investigated.

(3) Preheating time

Of soldering defects that occur in the soldering process, two of concern are the wicking phenomenon, in which solder is drawn up the package leads and the chip standing phenomenon, which can be seen for miniature chip components. Both of these defects are due to temperature unevenness during reflow.

Especially for high-density printed wiring boards, in which large numbers of components are mounted on a single board, the rate at which the temperature rises can differ due to the size of each component as shown in figure 3.5. A preheating stage is required to prevent these sorts of temperature differences.

Inversely, however, solder paste wetting characteristics can be degraded by excessive preheating. Therefore the preheating conditions must be set in advance based on a thorough evaluation.

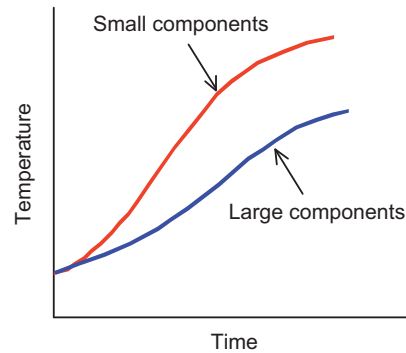


Figure 3.5 Temperature Rise Examples for Different Components

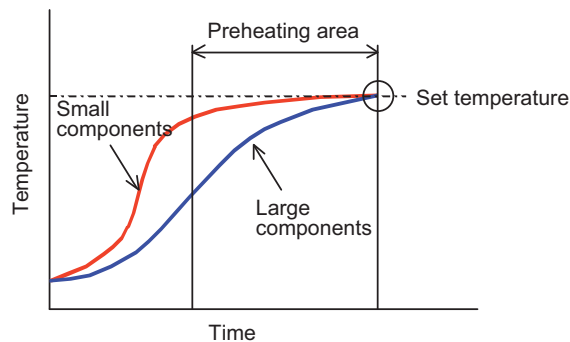


Figure 3.6 Temperature Equalization by Preheating Example

The reflow equipment temperature and conveyor speed must be adjusted so that the variations in temperature between the printed wiring board and the components is minimized (see figure 3.6) during the preheating time for the temperature profile as mentioned in section 3.3.1.

Furthermore, it is thought that capillary ball formation and insufficient wetting during soldering, which are defects during soldering, are due to problems with the preheating conditions during the reflow process.

The following items must be considered as preheating conditions during reflow to improve the above problems.

- The preheat temperature and time must be set so that the volatile components in the solder paste are adequately volatilized.
- The preheat temperature and time must be set so that the activation abilities of the activation agents in the solder paste are maximized.
- The preheat temperature and time must be set so that the activation agents in the solder paste are not degraded.

(4) Temperature slope

An excessively steep temperature slope can cause packages to crack.

For current reflow soldering equipment, we recommend considering temperature slopes in the range 1 to 3°C/second.

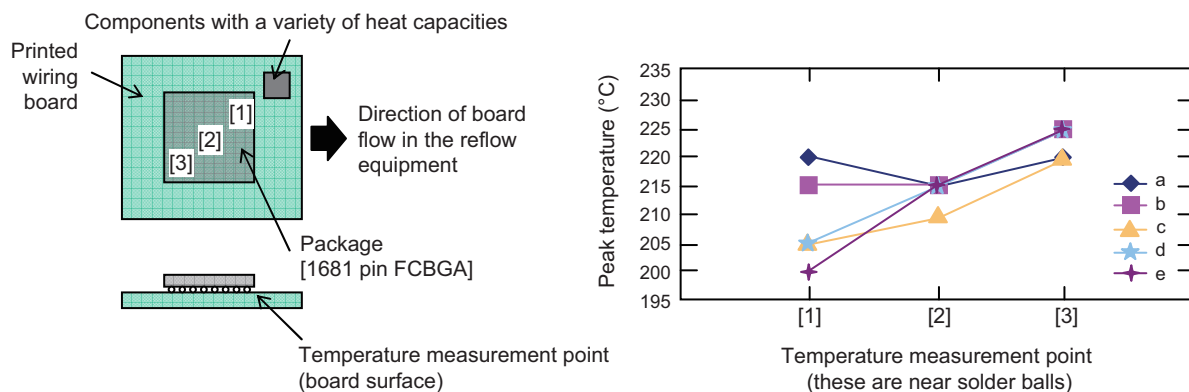
Also, the shininess of the solder surface can usually be improved by reducing the cooling speed.

Since temperature distributions can be larger within large BGA packages, the solder balls may not all solidify at the same time. Since the solder ball volume shrinks on solidification (it expands on melting), it is possible for differences in solder ball height to arise if solidified balls and melted balls occur adjacent to each other.

As a result, as the cooling slope increases, the height differentials also increase and at the same time warping of the printed wiring board and open circuit defects may occur. Therefore the cooling slope conditions must be set by careful a priori verification.

3.3.3 Notes on BGA Package Reflow Soldering

Variations in the package internal temperature are of concern when reflow soldering packages such as BGA and LGA packages that have soldered sections underneath the package. These temperature variations, however, can be minimized by making the preheat time in the soldering temperature profile as long as possible. Below, we present the results of an evaluation of FCBGA package temperature variations when components with a variety of heat capacities are contact mounted with an FCBGA package and the influence on solderability of those variations.



Heat capacity of adjacent component	Max. temperature for (1) to (3)	Min. temperature for (1) to (3)	Soldering failure mode		
			Open	Bridge	Other
a	220°C	215°C	0/5	0/5	0/5
b	225°C	215°C	0/5	0/5	0/5
c	220°C	205°C	0/5	0/5	0/5
d	225°C	205°C	0/5	0/5	0/5
e	225°C	200°C	0/5	0/5	1/5*

Note: * Voids occur in the solder ball.

Figure 3.7 BGA Solderability when Other Components are Mounted Nearby

The result of the above evaluation is that we verified that temperature differences occurred in adjacent sections due to the influence of the heat capacity of nearby components.

We also verified that voids and other defects can occur inside solder balls if the temperature does not rise adequately.

We strongly recommend that our customers carefully consider the placement and heat capacities of components on the printed wiring board when designing their reflow process.

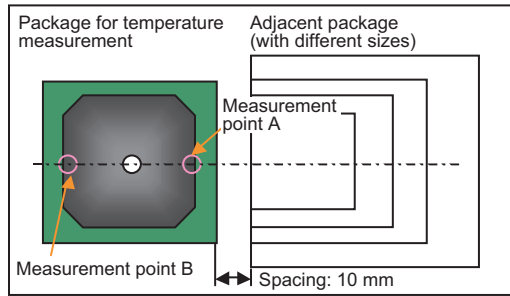
3.3.4 Temperature Distributions in Mixed Mounting

(1) Influence of the size of an adjacent package

For a given package being mounted, the larger the size an adjacent has, the larger will be the temperature differences within that package. (See the figure below.)

Thus this point also requires care when setting up a temperature profile.

Temperature Measurement Conditions



Package for temperature measurement
35×35 mm BGA

Adjacent package

- (1) 19×19 mm
- (2) 27×27 mm
- (3) 35×35 mm
- (4) 40×40 mm
- (5) 45×45 mm

Reflow soldering temperature: 232 to 233°C
(BGA ball)

Reflow furnace: Air type

Conveyor speed: 0.9 m/minute

Printed wiring board:

Number of layers: 4, Material: FR-4, Thickness: 1.6 mm

Temperature measurement points:

A: A ball close to the adjacent package

B: A ball distant from the adjacent package

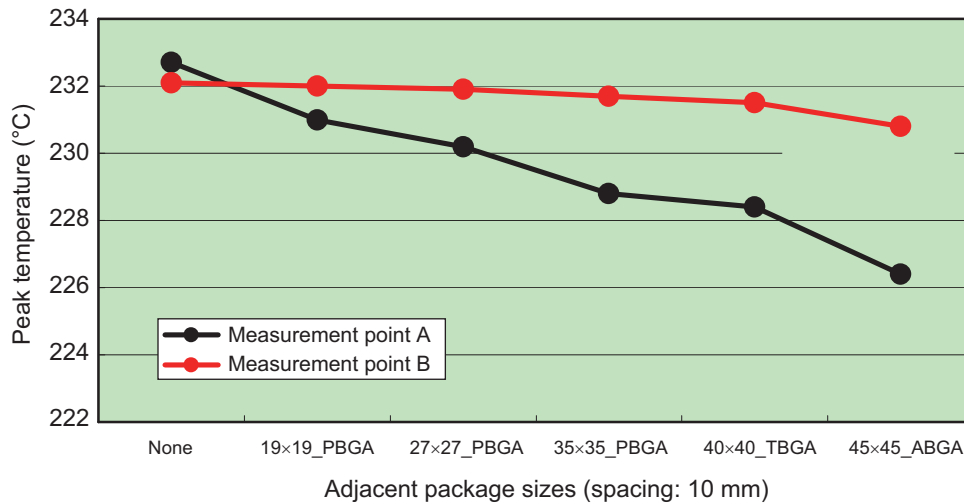
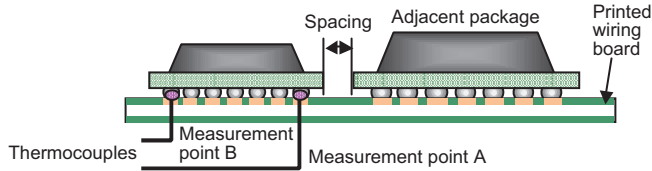


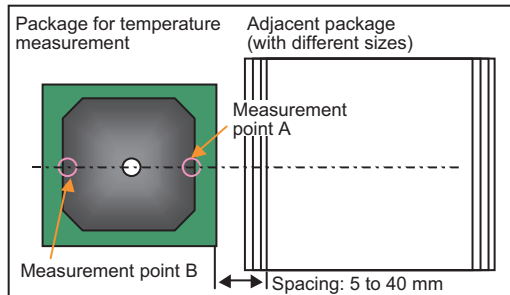
Figure 3.8 Influence of the Size of an Adjacent Package

(2) Temperature distribution due to the separation from the adjacent package

As shown in the figure below, temperature differences become larger as the separation from the adjacent package decreases.

We see from this that temperature differences occur within the same package.

Temperature Measurement Conditions



Package for temperature measurement
35×35 mm BGA
352 pin PBGA

Adjacent package
35×35 mm
352 pin PBGA

Reflow soldering temperature: 232 to 233°C
(BGA ball)

Reflow furnace: Air type

Conveyor speed: 0.9 m/minute

Printed wiring board:

Number of layers: 4, Material: FR-4, Thickness: 1.6 mm

Temperature measurement points:

A: A ball close to the adjacent package

B: A ball distant from the adjacent package

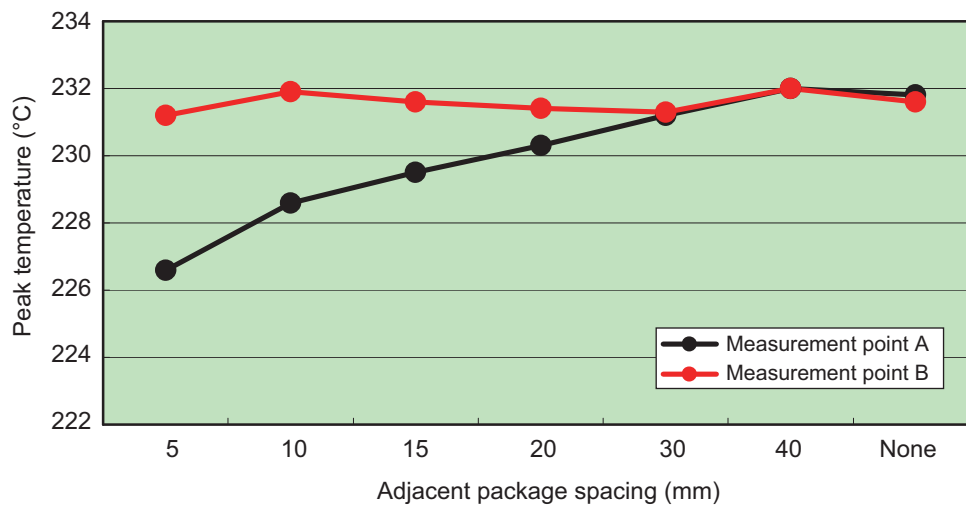
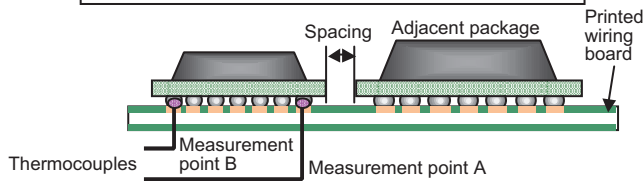


Figure 3.9 Influence of the Separation of an Adjacent Package

3.4 Cleaning Process

While a wide range of solvents have been used for flux cleaning after mounting components to the printed wiring board in the past, there are now increasingly strong demands for selective use of cleaning agents for environmental reasons, and for processes that do not include this cleaning at all.

The following items must be investigated when introducing cleaning using either solvents or water, or introducing a process with no cleaning.

(1) On the Necessity of Cleaning

The following items must be considered to determine the necessity of implementing flux cleaning after component mounting.

- The corrosion resistance, insulation resistance, migration and other properties of the flux used
- The required reliability level of the end product
- The environment in which the end product will be used
- The required quality under visual inspection
- The ability of the visual inspection to detect defects
- The necessity of in-circuit testing

(2) Flux Cleaning

If you determine that cleaning is required after evaluating the above necessity of cleaning conditions, there are four items that must be studied to determine the cleaning process: the flux used, the cleaning fluids, the cleaning method, and the cleaning equipment.

Table 3.6 lists these items together to provide an overview.

Table 3.6 Cleaning Process Selection Examples

Flux	Cleaning fluid	Cleaning method selection		Cleaning equipment selection
		Immersion cleaning	Use (or not) of ultrasonic cleaning	
Rosin flux	Petroleum-based cleaning agents	Immersion cleaning	Use (or not) of ultrasonic cleaning	Inline or batch
	Terpene-based cleaning agents			
	Semi-aqueous cleaning agents	Shower cleaning (including rinse cleaning)		
Water soluble flux	Water	Shower cleaning (including rinse cleaning) or immersion cleaning		Inline or batch
	Water + neutralizer	Shower cleaning (including rinse cleaning) or immersion cleaning		
		(including the use of neutralizers)		

In the following, we discuss the above four items and ways of deciding on the cleaning method.

3.4.1 Flux Selection

The flux used in soldering falls into two main categories: rosin-based fluxes and water soluble fluxes.

The rosin-based fluxes are currently the most widely used, and since under normal conditions the flux residues are nonhygroscopic and noncorrosive, they are seen as being usable without cleaning. Since a fairly large amount of halogens, such as chlorine, which are the main activating agents in the flux, remain after soldering, a thorough study of potential problems on insufficient cleaning is, however, required.

While the water soluble fluxes are fairly recent products, they are widely used in the US and other countries due to their properties listed below.

- They allow a quality of visual appearance after cleaning to be obtained that is superior to that of rosin-based fluxes.
- Good solderability
- The cleaning fluid used (water) is not harmful or toxic and is inexpensive.

While the water soluble fluxes do have these merits, their residues are corrosive and must be completely removed in cleaning. Furthermore, it may be necessary to perform thorough checking to verify that cleaning was complete.

Furthermore, no-clean fluxes have been developed by most flux manufacturers and are available commercially in bulk.

We recommend that you thoroughly evaluate fluxes based on consultations with the flux manufacturers.

- Ultralow residue flux
- Low residue flux
- Inactivated flux
- Flux with a chlorine content under 0.2 weight %

3.4.2 Cleaning Fluid Selection

The cleaning fluid must be selected according to the flux residue. Generally, the following cleaning fluids are used for the various fluxes.

(The cleaning fluid product names shown below are examples only. Before actual use, a thorough evaluation is required.)

When rosin-based flux is used

- Terpene-based solvents ... Cleaning fluids containing components extracted from oranges (rinsing required): Bio-Oct EC-7/EC-7R.
- Petroleum based solvents and mixtures of petroleum-based solvents and surfactants: P3 Cold Cream
- Hydrocarbon-based solvents and semi-aqueous solvents with added surfactants, making water rinsing possible: Pine Alpha ST-100S, Clean-Through 700 Series
- Alcohol-based solvents: isopropyl alcohol (IPA), ethanol, methanol
- Alkali-based solvents ... Mixtures of organic alkalis and surfactants.

When water-soluble flux is used

- Warm water
- Warm water and an alkali neutralizer

(1) Rosin-based Flux Cleaning Fluids

The following items should be considered when selecting cleaning fluids for rosin-based flux.

- The ability to dissolve ionic residues
- The ability to dissolve non-ionic residues
- The boiling point
- Compatibility with resins/plastics (the resins and plastics used in components and the printed wiring board)
- Stability and safety
- Wastewater handling (for terpene-based solvents, alkali rosin cleaners, and other fluids)

(2) Water-soluble Flux Cleaning Fluids

Consider using soft water or deionized water for cleaning water-soluble fluxes.

Hard water and other fluids with high hardness contain calcium, magnesium, and iron ions, and these can form insoluble salts in the water. These can form scaling on the heating elements in the cleaning tanks, plug up spray nozzles, and cause other problems.

When water cleaning is used, neutralizers may be adopted as auxiliary agents. Since these contain surfactants, we recommend consulting with the cleaning equipment manufacturer on the possible effects of these surfactants.

3.4.3 Selecting the Cleaning Method and Equipment

(1) Cleaning Using Organic Solvent Based Cleaning Fluids

The following are the main cleaning methods.

- Vapor cleaning
- Immersion cleaning (including ultrasonic cleaning)
- Shower cleaning

Generally, a combination of cleaning methods in which one is vapor cleaning is used.

1. Product damage during ultrasonic cleaning

If ultrasound is to be used in conjunction with immersion cleaning, users must verify, in advance, whether or not this can damage the mounted components. (Applying ultrasound should be avoided for hermetically sealed (structures with an inner cavity) type devices such as ceramic packages, since it can result in wire breakage.)

Also, assure that the printed wiring board and components being cleaned do not contact the ultrasonic actuator.

(Please refer to the reliability handbook for more information on conditions for ultrasonic cleaning.)

2. Water quality and effluent handling for rinse cleaning

When terpene-based or semi-aqueous cleaning agents are used, a water cleaning phase is introduced as a post-clean (rinse cleaning) operation. Here, a careful analyses of the water quality during the water cleaning itself, and of the water quality of the effluents, must be performed.

3. Safety precautions when using flammable solvents

The explosion prevention safety measures in cleaning equipment must be analyzed thoroughly when using alcohol, terpene-based solvents, semi-aqueous solvents, petroleum-base solvents, or other flammable solvent due to the danger of fire.

(2) Cleaning With Water

When water cleaning is used, generally the cleaning itself is implemented as a shower. This is followed by draining and then drying.

When water cleaning (including shower cleaning methods) is implemented, the washing conditions such as the spray pressure and the nozzle angles, the drying method, and the drying conditions require careful study.

Also, the waste water must be processed to conform to all national and local laws and regulations.

3.4.4 Assessment Methods

(1) Assessing the Cleaning Effect

The following methods can be used to assess the degree of cleaning achieved.

Cleaning degree assessment methods

- Visual assessment
- Contact angle and wetting indices
- Contaminant extraction concentration measurement method
- Optical methods
- Molecular spectroscopy methods

(2) No-clean Assessment Methods

When no cleaning is implemented, it is important to analyze the flux used. In particular, the following items must be evaluated.

- Corrosivity tests (e.g. the copper mirror test)
- Reactivity tests (e.g. the silver chromate paper test)
- Insulation resistance tests (e.g. high-temperature/high-humidity bias testing)
- Aqueous solution resistance measurement
- Actual equipment testing (reliability testing of the cleaned board as an actual product)
(reliability testing of each individual component)

Since the assessment standards used for each of the above items will differ with the reliability level required for the application and the specifications, the user must determine these standards based on a thorough analysis for each product.

3.5 Inspection Process

Due to increasingly smaller sizes and lighter weights in electronic equipment, all aspects related to the electronic components mounted in this equipment are seeing trends towards more minute sizes and higher densities. As a result, the post-soldering visual inspection previously carried out by direct visual inspection has become difficult. Also, due to the need to reduce the assembly costs for electronic equipment, there are increasing trends to push for the automation of the above-mentioned post-soldering visual inspection.

In this section we discuss the items that require study when introducing post-soldering visual inspection equipment.

Defects in soldering lead-type SMD packages include solder balls, wicking, no solder connection, and short circuits. These defects can be inspected for visually or with optical inspection equipment. While defects in soldering BGA, CSP, and similar packages include no solder connection and short circuits, since these are in places under the package that cannot be seen, they cannot be inspected with optical inspection equipment.

Although transmission X-ray equipment can detect short-circuit defects, it cannot detect no solder connection defects. To resolve this problem, there are 3D inspection methods for visual inspection of places that cannot be seen, such as locations under packages. The tomography synthesis method and the laminography method, which uses a scanning X-ray beam, are such methods.

Currently, the equipment for the methods listed in table 3.7 is commercially available as post-soldering visual inspection equipment.

Table 3.7 Visual Inspection Equipment

Inspection Method	Details of the Inspection Method
Optical systems	<ul style="list-style-type: none"> • Integrated laser/sensor rotating scan method • Color highlight method • Combined laser and multi-camera method • Laser scanning method
X-ray methods	<ul style="list-style-type: none"> • Methods in which X-ray transmission images are converted to 3D data showing the object's actual shape • Methods in which X-ray slice images are converted to 3D data showing the object's actual shape

We recommend that our customers carry out a thorough analysis of the following items when adopting visual inspection equipment.

- Clarification of the soldering visual inspection standards to be applied to actual products
- Setting up inspection items that are appropriate for an automatic system

Note: Since there are restrictions on what inspection items can be performed depending on the type of the visual inspection unit used, it is necessary to clarify the applicable scope when determining the equipment specifications.

- Inspection precision and repeatability
- Ease of operation of the visual inspection equipment

Note: Items such as the ease of setting the inspection standards (programming) and the time required to change equipment type must be checked.

- Equipment inspection tact time and price
- Maintainability

Note that if it is necessary to inspect the state of soldering for electronic components in which solder connections exist in places underneath the package, such as BGA and LGA packages, you should consider the use of X-ray inspection equipment.

Also note, however, that for certain products, there are cases where exposure to X-rays may adversely affect operation. Thus this equipment must only be used after thorough evaluation of its usability.

3.5.1 Visual Inspection Equipment

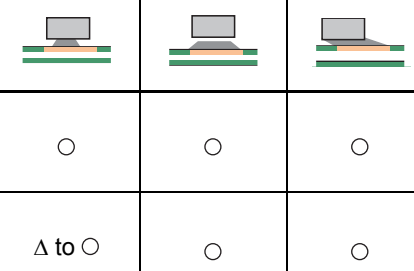
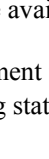

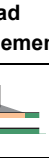








As the pitch of solder connection becomes narrower, and the size of the solder joints becomes finer, the amount of solder per place soldered and the area of the joint are reduced. As a result, inspection of the solder joints themselves and of the process up to soldering become increasingly important. While these inspections were previously done visually, recently, a wide variety of automated inspection equipment has become available commercially.

Currently there are two main types of visual inspection equipment for package pin soldering and mounting: visual inspection equipment for solder connections and paste printing state visual inspection equipment.

(1) Visual Inspection Equipment for Solder Connections

While previously, this equipment mainly focused on OK/NG inspections, recently, equipment that can also inspect for the mounting state of the components has also become available.

Table 3.8 Visual Inspection Equipment Overview

Methods and Principles		Defect Detected						
		Solder defect assessment				Mounting state defect assessment		
		Insufficient solder	Lead floating	Lead displacement	Bridge	Component missing	Positional displacement	Incorrect orientation
								
Step illumination		○	○	○	○	○	○	× to ○
Optical obstruction		△ to ○	○	○	○	○	○	× to △
Laser scanning		○	○	○	○	○	○	× to △
X-ray		○	○	○	○	○	△	×

○: Assessment possible, △: Some assessments possible, ×: Not supported

A value of 0.1 mm for lead flatness, which is particularly important for soldering quality, is standard for fine lead pitch packages. Technological advances that can promote improved quality in lead flatness are strongly desired.

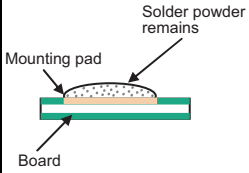
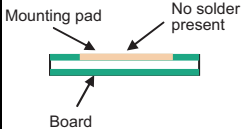
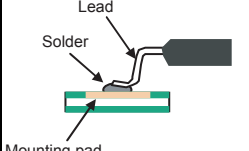
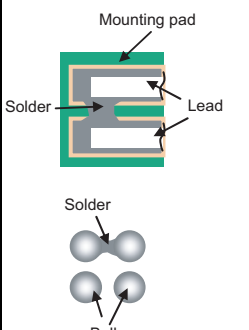
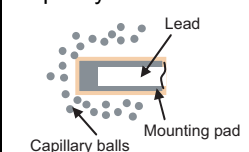
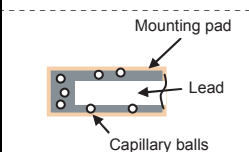
(2) Paste Printing State Visual Inspection Equipment

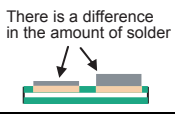
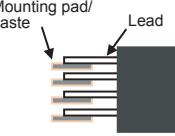
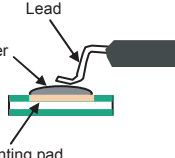
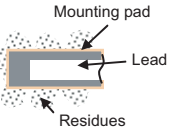
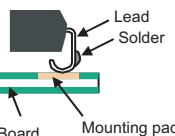
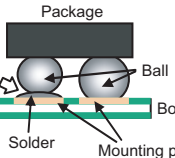
This is equipment that is intended to prevent soldering defects (excess or deficient solder, bridges) in advance by inspecting the solder printed form (volume, displacements, paste height, bridges, droop, unevenness, and other aspects) for the solder paste for fine lead pitch packages. There are currently two methods used: step illumination and laser scanning.

3.5.2 Visual Inspection Items

Items such as those listed in table 3.9 are tested with a visual inspection of the solder areas. For reference purposes in resolving issues, we also list causes of defects and measures to resolve the problem.

Table 3.9 Causes and Resolution Measures for Reflow Soldering Defects

Defect Item	Phenomenon	Cause	Resolution Measure
 <p>Solder not melting</p>	The state where solder powder remains	<ul style="list-style-type: none"> Inappropriate reflow conditions (preheat or melting) Degradation of the solder paste 	<ul style="list-style-type: none"> Review the reflow profile Verify the solder paste storage method Replace the solder paste
 <p>Not soldered</p>	There is no solder on the mounting pad, or only an extremely small amount.	<ul style="list-style-type: none"> Inappropriate printing conditions Degradation of the solder paste Clogged holes in the stencil 	<ul style="list-style-type: none"> Review the printing conditions (including the stencil thickness and size) Verify the solder paste storage method Replace the solder paste Clean the stencil
 <p>Insufficient spreading</p>	The solder did not spread around the mounting pad or lead adequately.	<ul style="list-style-type: none"> Too little solder paste used for printing Degradation of the mounting pads, leads, or solder Insufficient heat 	<ul style="list-style-type: none"> Review the stencil specifications Verify the storage methods for the mounting pads, leads, and solder paste Review the reflow profile
 <p>Bridge</p>	The solder melted and spread too far, reaching over to adjacent mounting pad or pin.	<ul style="list-style-type: none"> Too much solder paste used for printing Displaced printing position of the solder paste Bent component pins In appropriate mounting pad or resist dimensions 	<ul style="list-style-type: none"> Reduce the amount of solder used during printing (printing area and thickness) Change the printing method
 <p>Capillary balls</p>	Capillary balls are present around mounting pads or components	<ul style="list-style-type: none"> Solder paste was printed beyond the mounting pads. Solder paste smeared beyond the mounting pads. Solder paste stuck to the back side of the stencil transferred to the work. 	<ul style="list-style-type: none"> Print somewhat smaller than the mounting pad size Switch to a solder paste with minimal droop Clean the stencil
 <p>Capillary balls</p>	Solder grains (capillary balls) are present on the surface of the reflow processed solder.	<ul style="list-style-type: none"> Insufficient heating (temperature, time) Excessive preheating Degradation of the solder paste 	<ul style="list-style-type: none"> Review the reflow profile Verify the solder paste storage method

Defect Item	Phenomenon	Cause	Resolution Measure
Uneven amount of solder 	The amount of solder on the soldered areas differs	<ul style="list-style-type: none"> The solder paste printability (release properties) are poor The printing conditions are inappropriate. 	<ul style="list-style-type: none"> Switch to a solder paste with good printability. Review the printing conditions
Component positional displacement 	Soldering was performed with components displaced from their correct positions	<ul style="list-style-type: none"> Components were mounted displaced Insufficiently adhesive solder paste Insufficient pressure at component mounting Floating by the flux Abnormal component dimensions 	<ul style="list-style-type: none"> Review the positions where components are mounted Use a solder paste that has higher adhesiveness Review the component mounting conditions Reduce the amount of flux in the solder paste Verify the component dimensions
Floating components 	There is no solder on the pin and it has lifted	<ul style="list-style-type: none"> Positional displacement in printing or mounting The amount of solder paste printed is uneven Insufficient melting time Deformation of QFP or similar package pins There are discrepancies in the solder melting time Insufficient pressure in the mounting equipment 	<ul style="list-style-type: none"> Print so that there is no positional displacement Reduce the amount of flux in the solder paste Use packages with pins with less deformation Review the printing conditions Make the thickness of the solder paste printed thicker Review the heating conditions
Inadequate cleaning 	After cleaning, flux residues or white powder residues are present	<ul style="list-style-type: none"> The flux used has poor cleaning characteristics Inappropriate cleaning agents/methods Work left standing for extended periods after reflow 	<ul style="list-style-type: none"> Use a solder paste with better cleaning characteristics Review the cleaning agents and cleaning methods used Clean the work as soon after reflow as possible
Wicking 	Phenomenon in which the melted solder is wicked up the sides of the leads. The fillet between the lead and mounting pad becomes smaller. (This can easily occur in the VPS method when the work is heated rapidly.)	The lead temperature rises more rapidly than the mounting pad and reaches the solder melting temperature first.	<ul style="list-style-type: none"> Use adequate preheating in the VPS method Use an IR reflow furnace for soldering
Head-in-Pillow 	The state in BGA mounting where the outer ball do not fuse correctly to the solder on the mounting pad.	<ul style="list-style-type: none"> The amount of solder printed is uneven The melting time is insufficient The pressure used in the mounting equipment is insufficient Pin surface oxidation Insufficient solder paste activation 	<ul style="list-style-type: none"> Review the solder printing conditions Review the heating conditions Review the mounting conditions Check the package storage state

3.6 Repairing and Reworking

This section presents an overview of repairing and reworking (component replacement) for post-soldering defects as well as examples of these operations.

3.6.1 Repairing

A soldering iron can be used to repair soldering defects for packages that have leads that extend beyond the package periphery. The soldering iron temperature and usage must be set so that the package surface temperature does not exceed its maximum allowable temperature. Note that there are products for which the soldering iron usage conditions are stipulated. Contact your Renesas sales representative for details.

Note that soldering iron repair for packages, such as BGA, LGA, and QFN, that have pins underneath the package is not possible. For packages that previously could not be repaired using a soldering iron, we suggest reworking (component replacement) using the equipment shown in figure 3.10.

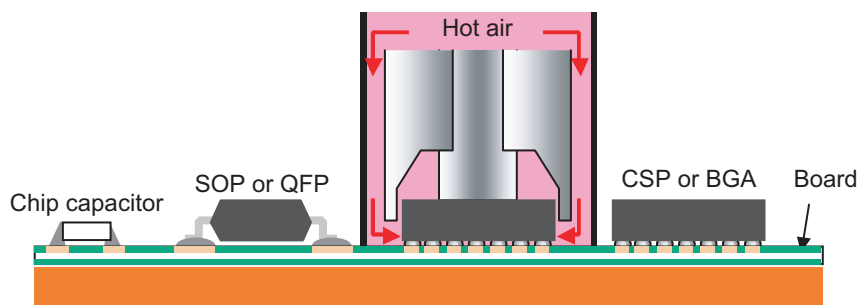


Figure 3.10 Example of Equipment for Reworking BGA, LGA, and QFN Packages

The following items must be observed when performing the repairs described above. These items also apply to reworking.

- The influence of the heating on adjacent pins must be minimized.
- Since the heating conditions will differ due to differences in the heat capacities of the printed wiring board (board thickness, number of layers) and mounted components used. Therefore the conditions must be set to correspond to the actual product and its mounted components.
- Reusing mounted components after repair or reworking requires verification with the manufacturer of each component.

Note: Renesas quality guarantees do not apply to components that have been removed during package reworking (component replacement). Therefore we strongly recommend that component reuse be avoided if at all possible.

3.6.2 Reworking

When a package is replaced and a new package mounted due to functional defects in the original product, this can be performed using the local heating methods described in the previous section for repairing.

Note that since quality guarantees do not apply to products that have been removed in reworking, we strongly recommend that component reuse be avoided if at all possible.

The flowcharts shown below are examples of reworking procedures.

The rework method (SMD type, THD type, etc.) differs according to the device package shape (figures 3.11 and 3.12).

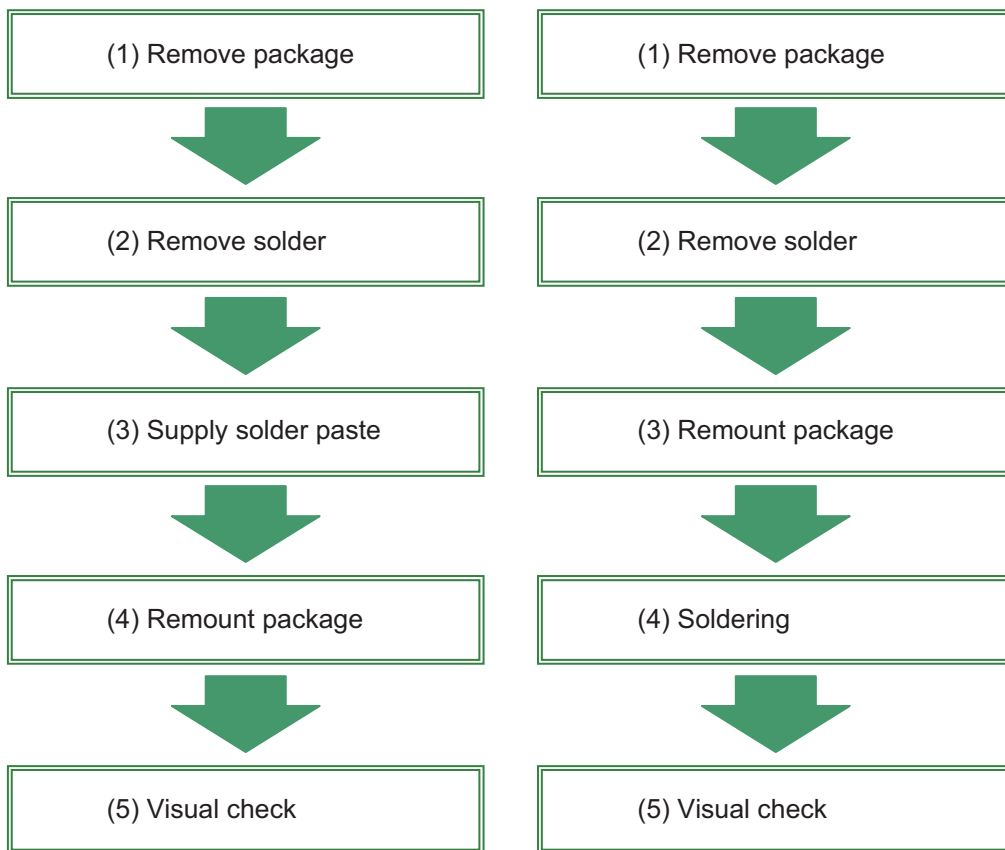


Figure 3.11 SMD Type Rework Process **Figure 3.12 THD Type Rework Process**

In the following pages, we describe the process steps using the BGA package as an example.

(1) Removing Package

In the case of BGA and CSP, the solder joint is located on the bottom of the package, so the solder is melted by heating up the entire package while it is covered, using specialized equipment, jigs and tools.

The temperature conditions at this time should minimize temperature variations within the package, and non-melted solder joints must be avoided.

Figure 3.13 shows an example of attachment of a sensor during temperature measurement.

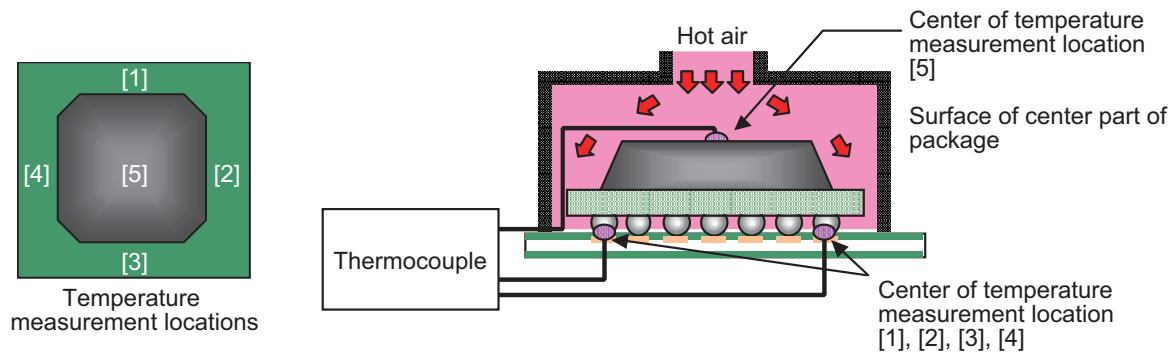


Figure 3.13 Example of Sensor Attachment during Temperature Measurement

Figure 3.14 shows an example of the BGA having been removed and the solder remaining in pinholder shapes. If the temperature is low, pad peeling may occur, so caution is required.

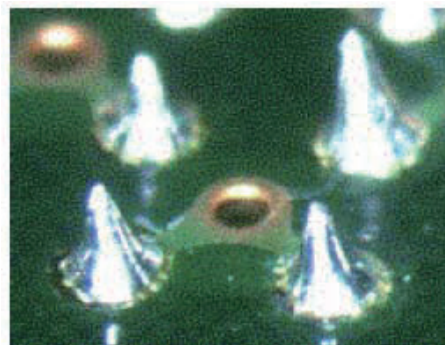


Figure 3.14 Trace After BGA Removal (Printed Wiring Board Side)

If the printed wiring board is large, it is important to avoid bending of the printed material due to selective heating, so a bending prevention tool must be placed on the bottom of the printed wiring board, and a bottom heater installed to allow heating of the entire printed wiring board in order to raise work efficiency.

(2) Removing Solder (Pad Cleaning)

Neatly remove the solder that remains on the pad using a solder sucker, soldering iron, solder wick, etc. after applying flux.

Figure 3.15 shows the pad states following cleaning using these various methods.

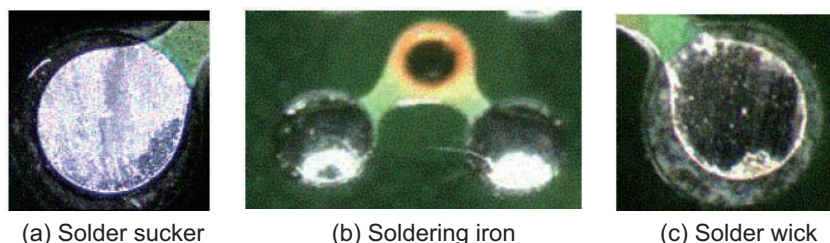


Figure 3.15 Pad States Following Cleaning

Pad cleaning must be performed with care.

Leftover solder residue and projections cause the stencil to not closely adhere to the substrate during solder paste printing, leading to improper solder paste supply.

Moreover, when the solder resist peels all the way to an adjacent through-hole, the solder paste printed on the pad gets sucked to the through-hole during reflow, which may cause improper connection.

Figure 3.16 shows examples of cleaning work defects.

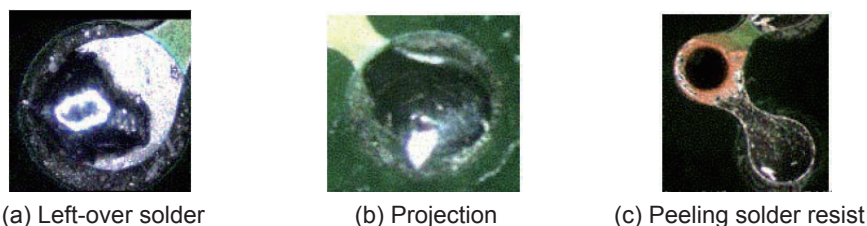


Figure 3.16 Examples of Cleaning Work Defects

(3) Supplying Solder Paste

Solder supply during rework is done using specialized jigs and tools. Examples for wide spacing and narrow spacing between parts are described below.

[Relatively wide spacing between parts]

As shown in figure 3.17, fix the partial stencil on the printed wiring board using tape, and print the solder paste with a squeegee (figure 3.18).

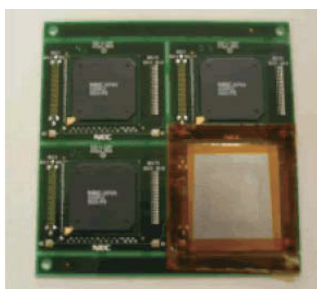


Figure 3.17 Partial Stencil Attached

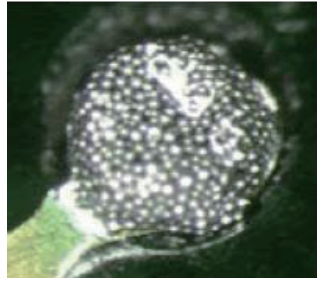


Figure 3.18 Solder Paste Printed on Partial Stencil

[Narrow spacing between parts]

If the spacing between parts is too narrow to attach a simple partial stencil, there is also the method of supplying solder paste on the BGA balls, as shown in figure 3.19.

The procedure is shown below.

1. Fix the package with a jig, etc. (figure 3.20).
2. Fix the partial stencil to cover the package as shown (figure 3.21).
3. Print the solder paste with a squeegee.

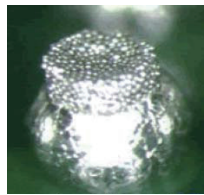


Figure 3.19 Solder Paste Printed on BGA Ball

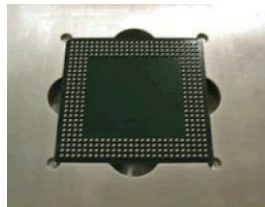


Figure 3.20 BGA Set on Jig

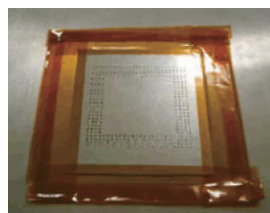


Figure 3.21 Stencil Set on BGA

(4) Remounting Package (Mounting and Reflow)

When remounting the package, it is recommended to use rework equipment that allows aligning of the solder balls of the package and the pads of the printed wiring board for correct soldering.

Take the following into consideration during remounting.

- As with removal, make sure to eliminate temperature variations in the temperature profile of BGA ball device.
- Keep the package's surface temperature from exceeding the stipulated temperature.

(5) Visual Check

Check with the same method as normal mounting.

(6) Solder Joint Reliability after Rework

Table 3.10 lists temperature cycling test results of the reworked items described as examples.

Comparable connection reliability was obtained for reworked items and non-reworked items in this example.

Table 3.10 Temperature Cycling Test Results

Rework Yes/No	Solder Paste Supply Point	Temperature Cycling Test Results (No. of Defective Devices/Input Devices)			
		0 cycles	500 cycles	1000 cycles	2000 cycles
None (Ref.)	—	0/12	0/12	0/12	0/12
Yes	On PWB pads	0/12	0/12	0/12	0/12
Yes	On BGA balls	0/12	0/12	0/12	0/12

Package: 35 × 35 mm/352 pin PBGA (daisy chain)

Solder ball diameter: 0.75 mm (Sn-Pb eutectic solder)

Temperature cycle conditions: -40°C to 125°C

Failure definition: 20% nominal resistance increase.

4. Notes on Storage and Mounting

4.1 Solderability

Depending on their fabrication process history, the surface of external leads of lead type SMD may oxidize, molding residue may appear during mold resin sealing, and impurities may adhere.

Such conditions may cause the leads to corrode and thus cause soldering defects during the process of soldering parts onto the printed wiring board, or during the socket mounting process (mechanical joint defects), or poor electric conduction. Therefore, in addition to removing the oxidized film on the surface of external leads and protecting the lead material, it is necessary to implement surface treatment so as to facilitate soldering and socket mounting.

4.1.1 Plating Composition

Renesas Electronics' device lead exterior plating specifications are as follows.

Table 4.1 Pin Plating Compositions

	Previous Plating Materials	Lead-Free Plating Materials			
Composition	Sn-10Pb	Sn-2Bi	Sn-1.5Cu	Sn	Ni/Pd/Au

4.1.2 Solderability Evaluation Method

One of the solderability evaluation method is the quantitative measurement method known as solder equilibration method (wetting balance method) (EIAJ-ET-7401). Figure 4.1 shows a meniscograph curve indicating the measurement mechanism.

The shorter the wetting time (B to E in figure 4.1), the better the solderability.

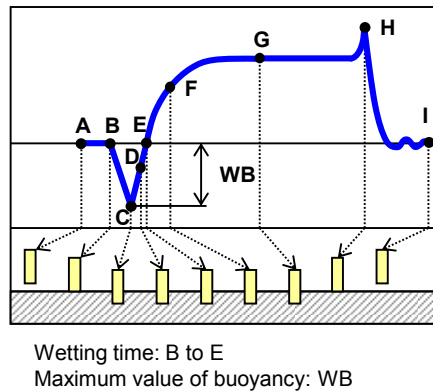


Figure 4.1 Meniscograph Curve by Solder Equilibration Method

Wetting time measurement examples obtained using the solder equilibration method for different plating materials are shown below.

(1) Evaluation Results for Sn-37Pb Solder Bus (Solder Temperature: 230°C)

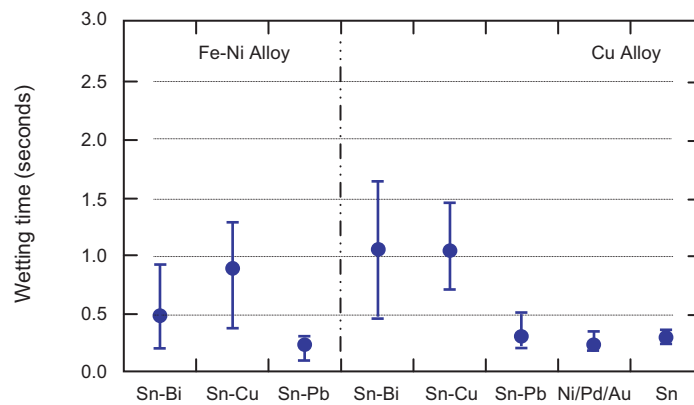


Figure 4.2 Wetting Time Measurement Results (Sn-37Pb Solder Bath)

(2) Evaluation Results for Sn-3Ag-0.5Cu Solder Bath (Solder Temperature: 245°C)

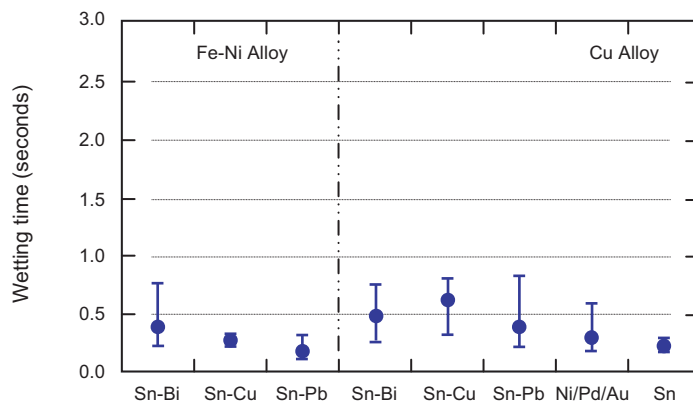


Figure 4.3 Wetting Time Measurement Results (Sn-3Ag-0.5Cu Solder Bath)

4.1.3 Plating Thickness

Next, mounting evaluation examples of a case in which the lead plating thickness is reduced are introduced.

Satisfactory solderability was obtained even in the case of reduced plating thickness as shown in figure 4.4. Even if the plating thickness is reduced in areas as a result of contact friction/scraping during the electrical test process following lead plating, the solderability should not suffer.

Package	QFP144-20x20-0.5 (Plating composition: Sn)		
Mounting Condition	Solder paste composition: Sn-3Ag-0.5Cu, reflow temperature (peak): 214.9°C		
Plating Thickness	Thin plating Ave. 5 μm	Normal plating Ave. 10 μm	Thick plating Ave. 17 μm
Before mounting			
After mounting			

Figure 4.4 Plating Thickness and Solderability

4.1.4 Wetting Time Temperature Dependence

This section presents an example of evaluation of the temperature dependence of wetting time.

When mounting electronic components on a printed wiring board, insufficient wetting may occur due to insufficient heating during mounting.

Figures 4.5 and 4.6 show the results of investigating the temperature dependence of the wetting time listed in table 4.2, Test Conditions.

Table 4.2 Meniscograph Test Conditions

Flux	Rosin — R Type
Sample	100-pin LQFP (Cu alloy)
Test temperature	See figures 4.5 and 4.6.
Immersion speed	15 mm/s
Immersion depth	0.15 mm
Immersion time	5 s
Number of leads immersed	1
Number of tests	5
Storage conditions	100°C, 100%, 4 hours

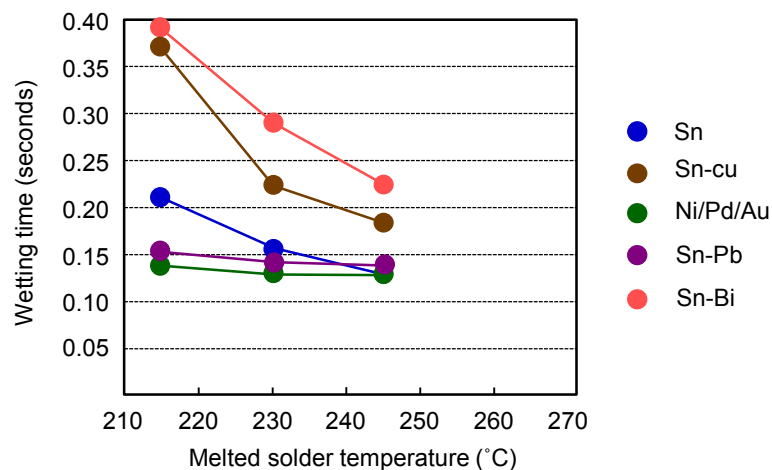


Figure 4.5 Wetting Time Temperature Dependence Evaluation Results (Sn-37Pb solder bath)

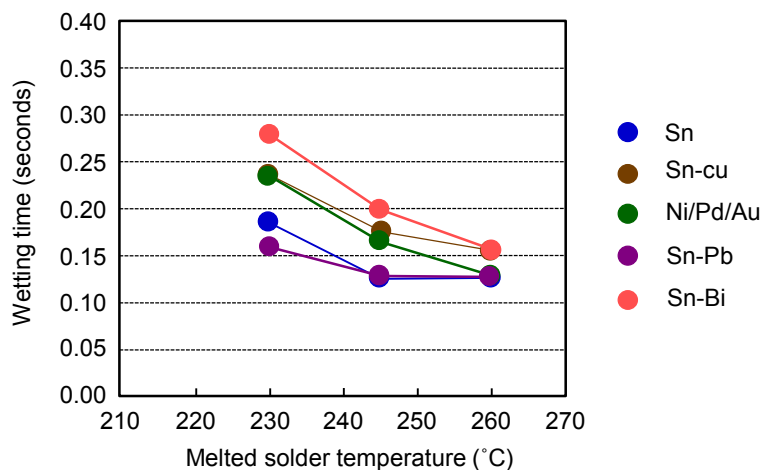


Figure 4.6 Wetting Time Temperature Dependence Evaluation Results (Sn-3Ag-0.5Cu solder bath)

As shown in figure 4.5 and 4.6, for both of these solders when melted, the wetting time increases as the temperature falls, and this indicates that the same trend will hold for printed wiring board mounting as well.

It is thought that using a higher mounting temperature can be effective for acquiring good solder wetting. Therefore we recommend taking this into consideration when selecting the optimal soldering conditions.

While the allowable temperature profile will differ depending on the solder paste used and the electronic components being mounted, we recommend setting the temperature to the high end of the possible range.

4.1.5 Solderability following High-Temperature Storage

Table 4.3 and figure 4.7 show the solderability when high-temperature baking (150°C) is performed for up to 500 hours.

These results indicate stable solderability with the wetting time remaining unchanged even after 500 hours.

Table 4.3 Meniscograph Testing Conditions (Sn-37Pb bath)

Flux	Rosin — R Type
Sample	208-pin QFP (Cu alloy)
Test temperature	210°C
Immersion speed	10 mm/s
Immersion depth	1.5 mm
Immersion time	5 s
Number of leads immersed	10
Number of tests	10
Storage conditions	150°C

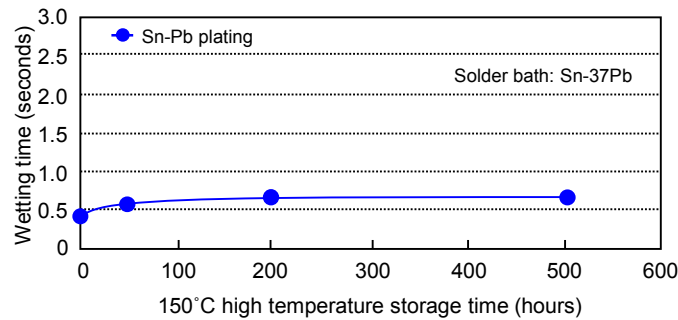


Figure 4.7 Results of Wetting Balance Test

Table 4.4 and figure 4.8 show the solderability when high-temperature baking (150°C) is performed for up to 500 hours. These results indicate stable solderability with the wetting time remaining unchanged even after 500 hours.

Table 4.4 Meniscograph Testing Conditions (Sn-3Ag-0.5Cu bath)

Flux	Rosin — R Type
Sample	208-pin QFP (Cu alloy)
Test temperature	245°C
Immersion speed	10 mm/s
Immersion depth	1.5 mm
Immersion time	5 s
Number of leads immersed	10
Number of tests	10
Storage conditions	150°C

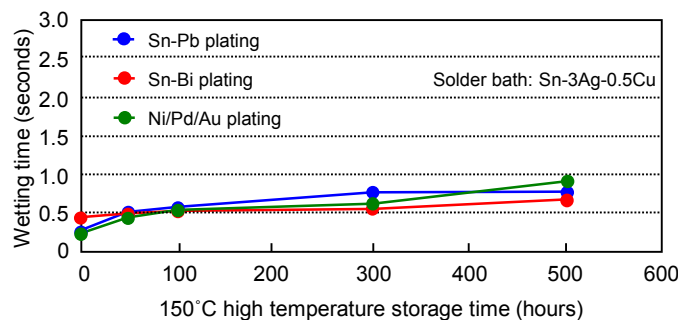


Figure 4.8 Results of Wetting Balance Test

4.1.6 Solderability following Long-Term Storage

(1) Lead Materials: Cu — Sn-3Ag-0.5Cu Solder Bath

The following shows the results of wettability testing with an Sn-3Ag-0.5Cu solder bath for devices that use an Cu alloy as the lead material after long-term storage under differing storage environments.

These results show that even after storage for two years under differing packing conditions, there is almost no change in the wetting time and that the solder wetting characteristics remain good.

Table 4.5 Meniscograph Testing Conditions (Sn-3Ag-0.5Cu bath)

Flux	Rosin — R Type
Sample	208-pin QFP (Cu Alloy)
Test temperature	245°C
Immersion speed	10 mm/s
Immersion depth	1.5 mm
Immersion time	10 s
Number of leads immersed	10
Number of tests	10
Storage conditions	25 ±5°C and 50 ±30%RH

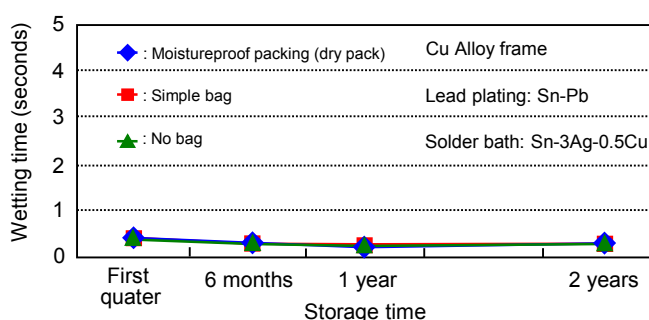


Figure 4.9 Results of Wetting Balance Test

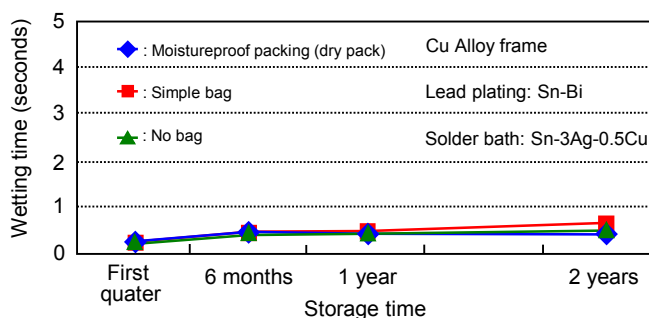


Figure 4.10 Results of Wetting Balance Test

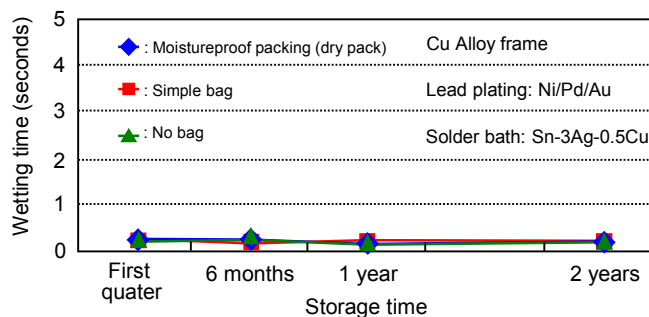


Figure 4.11 Results of Wetting Balance Test

4.2 Package Storage Conditions

When a package adsorbs moisture, the expansion on vaporization of this moisture due to the heat applied during reflow soldering can cause separation or cracking within the package. A plastic package absorbs moisture even when it is stored at room temperature. If the package is subjected to heat stress of soldering, the reliability of the device may be degraded, or delamination or cracks may occur inside the package. Since this separation or cracking can cause open circuits in the wiring within the package or degradation of device reliability, we strongly recommend that such packages only be used under the conditions stipulated in the items below.



Figure 4.12 Package Crack

See the Renesas Reliability Handbook for the detailed mechanisms, reasons for occurrence, methods for avoidance, and other information on package cracking during reflow soldering.

4.2.1 Storage Before Opening Moisture-Proof Packing

Before opening moisture-proof packing, semiconductor devices must be stored at a temperature in the range 5 to 35°C and at a humidity under 85%RH. Note, however, that individual products may have product-specific stipulations. Thus all products must be stored only after verifying the conditions stipulated in the delivery specifications documents.

4.2.2 Storage After Opening Moisture-Proof Packing

After opening moisture-proof packing, semiconductor devices must be stored under the following conditions to prevent moisture absorption by the packages.

Table 4.6 Storage Condition Examples

Item	Condition	Notes
Temperature	5 to 30°C	
Humidity	Under 70%RH	
Time	168 hours	The time from the point the packaging is opened until mounting the last device has completed.

Note, however, that individual products may have product-specific stipulations. Thus all products must be stored only after verifying the conditions stipulated in the delivery specifications documents. Figure 4.13 presents examples of moisture absorption characteristics for plastic packages of different thicknesses.

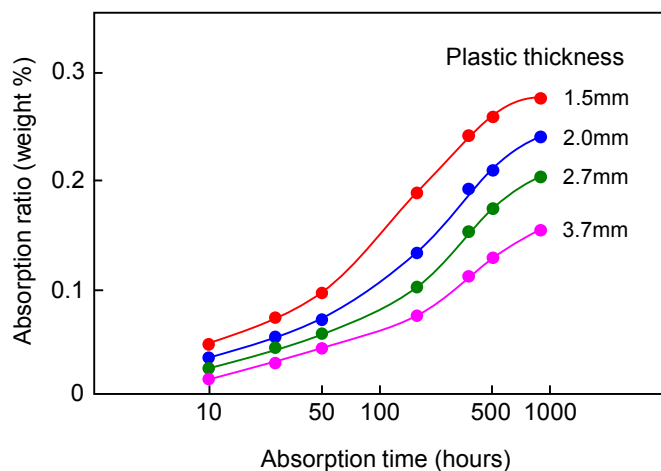


Figure 4.13 Examples of Plastic Package Moisture Absorption Characteristics

4.2.3 Baking

Before soldering, perform the baking operation described below.

(1) Cases Where Baking Is Required

- If the 30% spot on the indicator card packed together with the product at moisture-proof packaging time has turned pink.
- If the stipulated storage conditions after opening the moisture-proof packaging have been exceeded.

(2) Baking Conditions

Baking must be implemented so as to meet the following conditions. Note, however, that individual products may have product-specific stipulations. Therefore the baking (drying) processing must be implemented only after verifying the conditions stipulated in the delivery specifications documents.

Use heat-resistant trays during the baking process. Heat-resistant trays will be marked either “HEAT PROOF” or with their heat-resistance temperature. Verify this marking before using any tray for this processing.

Table 4.7 Baking Condition Examples

	Baking Temperature	Baking Time	Repeated Baking
Thin-form packages with a mounting height of 1.2 mm or less	125 ±5°C	4 to 24 hours	No more than 96 hours total
All other packages	125 ±5°C	16 to 24 hours	No more than 96 hours total

4.2.4 Reflow Cycles

Do not perform more than three reflow operations. Note, however, that individual products may have product-specific stipulations. Therefore, verify the conditions stipulated in the delivery specifications documents and only apply a number of cycles equal to or less than the number stipulated in those specifications. Furthermore, the number of reflow cycles used must be set based on a comprehensive verification that no other problems can occur.

4.3 Soldering Temperature Profiles

The soldering temperature profile used must be set based on careful consideration of the heat resistance and solderability of the parts used.

4.3.1 Heat Resistance Profiles

Compared to the previously used eutectic solders, the lead-free solders used due to the elimination of lead in solders have a higher melting point and the corresponding peak temperatures during reflow required of semiconductor devices have increased (when measured at the package surface) from 235°C for eutectic solder to 260°C for lead-free solders. We have verified the heat resistance for existing surface mounting packages under the lead-free solder heat resistance conditions. Almost all packages were able to withstand a reflow peak temperature of 260°C. However, for thicker and larger packages, since it is harder to increase the surface temperature of these packages, we have set the peak temperature to be 250 or 245°C. Even in these cases, however, the temperature of the lead sections will rise above the melting temperature of the Sn-Ag-Cu solders widely used as lead-free solder. Thus there will be no problems in mounting such packages.

Note that “Moisture/Reflow Sensitivity Classification for Non-hermetic Solid State Surface Mount Devices” standards are widely adopted worldwide. Except for a few products, the IPC/JEDECJ-STD 020B can be applied without problem. We are also performing evaluations of products to determine whether or not they conform for the J-STD 020D, which was promulgated in June 2007.

Please contact your Renesas sales representative for information on specific products.

(1) Renesas Support for the IPC/JEDEC MSL Standard Reflow Conditions

For prior to processing moisturization conditions verified as MSL (moisture sensitivity levels), Renesas, as a principle, stipulates level 3 for moisture-proof packed products and level 1 for products that are not moisture-proof packed.

Figure 4.14 shows the IPC/JEDEC J-STD 020D stipulated reflow conditions for Renesas products and table 4.8 lists the peak temperatures for package volumes and thicknesses.

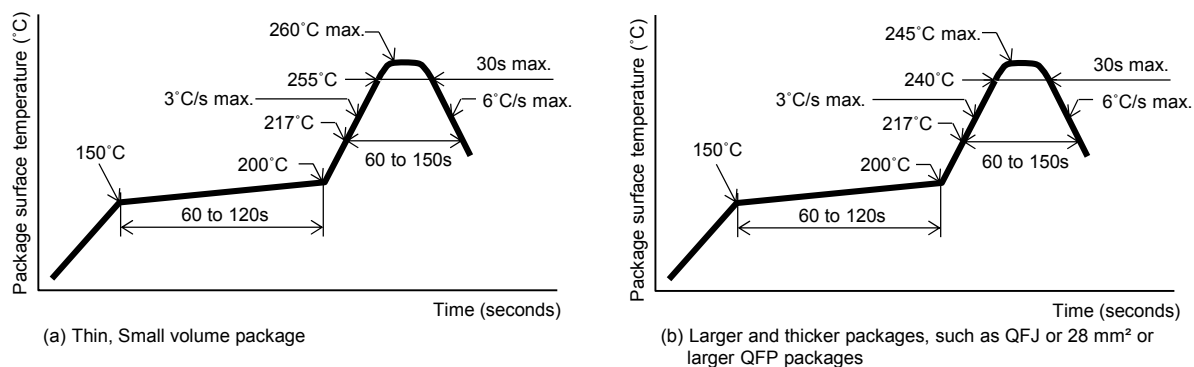


Figure 4.14 Reflow Heat Resistance Temperature Profiles for IPC/JEDEC Standards

Table 4.8 Reflow Peak Temperatures for IPC/JEDEC Standards

Thickness	Volume		
	Under 350 mm ³	350 mm ³ to 2000 mm ³	Over 2000 mm ³
Under 1.6 mm	260°C	260°C	260°C
1.6 mm to 2.5 mm	260°C	250°C	245°C
2.5 mm or thicker	250°C	245°C	245°C

Notes: 1. Profiles for individual products are shown in the delivery documents. Either check the delivery documents or contact your Renesas sales representative for details.

2. For prior to processing moisturization conditions verified as MSL (moisture sensitivity level) ratings, Renesas, as a principle, stipulates level 3 for moisture-proof packed products and level 1 for products that are not moistureproof packed. Contact your Renesas sales representative for MSL ratings for individual products. Note, however, that temperature measurements are made at the top surface of package body. After opening the moisture-proof packing, products must be stored in an environment where temperature and humidity are less than 30°C and 70%RH, respectively.
 Note, however, that individual products may have product-specific stipulations. Therefore, always verify the storage conditions stipulated in the delivery specifications documents for each individual product used.
3. The reflow conditions for the larger and thicker HQFP packages that have a size of over 28 mm² and have a built-in heat sink are as follows: peak temperature: 240°C maximum; main heating: 235°C for 10 s maximum, time at over 220°C: 30 to 50 s, preheating 150 to 180°C for 90 ±30 s.
4. Some products have the conditions marked on them with a symbol. See section 4.3.2 for details on these conditions.

4.3.2 Heat Resistance Temperature Profile Symbols

Certain heat resistance temperature profiles stipulated for individual products are indicated using symbols. This section describes these temperature profiles and their symbols.

(1) Description Method

The individual product soldering conditions indicated with symbols consist of the five items described below. The profile is stipulated by the combination of these symbols.

- Soldering method
- Maximum temperature
- Baking time
- Number of storage days after the moisture-proof packaging (dry pack) has been opened
- Number of times the product can be mounted

These symbol codes are used in combination as shown in the example in figure 4.15 below.

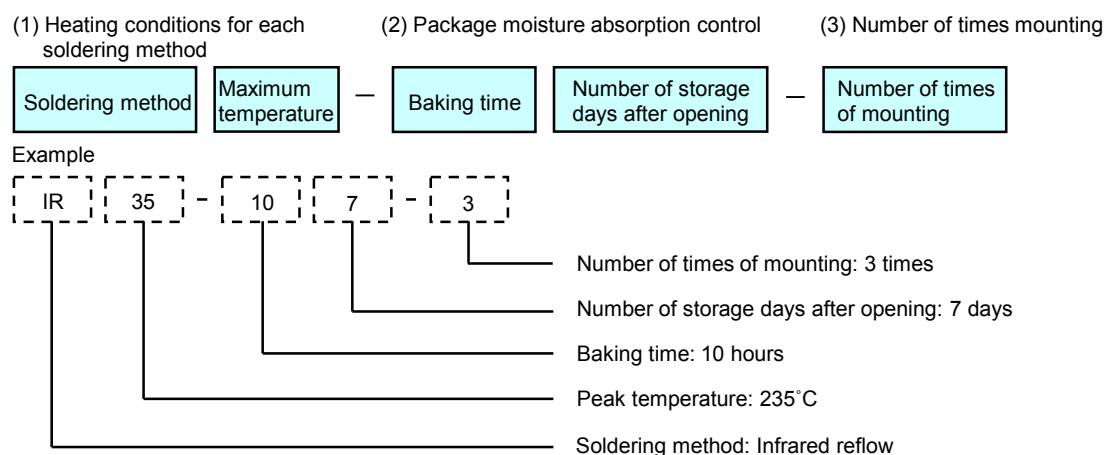


Figure 4.15 Soldering Heat Resistance Condition Symbols and Example

(2) Symbol Definitions

[Soldering method]

The soldering method is indicated by a code consisting of two letters of the alphabet, shown in the table below.

Table 4.9 Soldering Method

Symbol	Soldering Method
IR	Infrared reflow
VP	VPS
WS	Wave soldering

[Maximum temperature]

The peak temperature is indicated by the lower two digits of the specified peak temperature. Note that the package surface temperature is indicated if the recommended soldering method is infrared reflow or VPS, and that the molten solder temperature is indicated if the soldering method is wave soldering.

Table 4.10 Maximum Temperature

Symbol	Maximum Temperature
20	220°C
30	230°C
35	235°C
50	250°C
60	260°C

[Baking time]

The recommended baking time is indicated by using two numerical digits, shown in the table below.

Table 4.11 Baking Time

Symbol	Baking Time
00	Baking unnecessary (0 hours)
10	10 hours min., 72 hours max.
20	20 hours min., 72 hours max.
36	36 hours min., 72 hours max.

[Number of storage days after opening moisture-proof packaging (dry pack)]

The number of days during which the product can be stored after the moisture-proof packaging (dry pack) has been opened is indicated by the symbols shown in the table below.

Table 4.12 Number of Storage Days After Opening Moisture-proof Packaging (Dry Pack)

Symbol	Number of Days
1	1 day (24 hours) max.
2	2 days (48 hours) max.
3	3 days (72 hours) max.
7	7 days (168 hours) max.
None	Not limited

[Number of times of mounting]

The number of times the product can be mounted is indicated by the symbols shown in the table below.

Table 4.13 Number of Times of Mounting

Symbol	Number of Times
1	1
2	2 times max.
3	3 times max.

Remark: The above symbol codes apply to the products that can be soldered by means of a total heating method. Some of Renesas Electronic's SMDs, however, cannot be soldered by a total heating method, and a code "partial heating" indicating that these products must be soldered by a partial heating method is used for such products.

(3) Heat Resistance Temperature Profile

In the following, we show the various soldering method temperature profiles marked by these symbols.

a. IR reflow 220°C (IR20)

The table below lists the soldering heat resistance conditions (IR20) for IR reflow.

Table 4.14 Heat Resistance Conditions (IR20)

Maximum temperature (package's surface temperature)	220°C or below
Time at maximum temperature	10 s or less
Time of temperature higher than 183°C	60 s or less
Preheating time at 120°C to 160°C	60 to 90 s
Maximum chlorine content of rosin flux (percentage mass)	0.2% or less

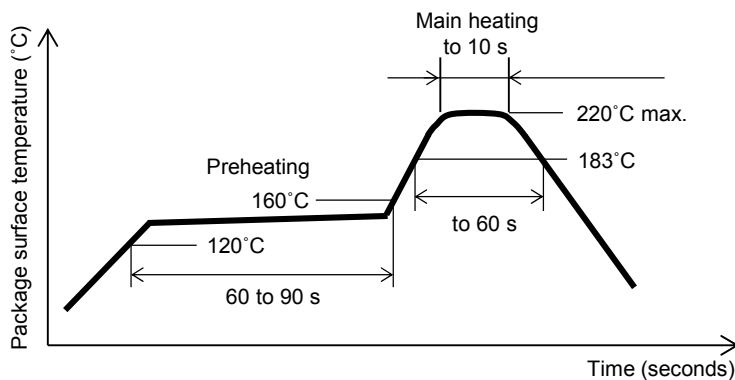


Figure 4.16 Infrared Reflow Temperature Profile (IR20)

b. IR reflow 230°C (IR30)

The table below lists the soldering heat resistance conditions (IR30) for IR reflow.

Table 4.15 Heat Resistance Conditions (IR30)

Maximum temperature (package's surface temperature)	230°C or below
Time at maximum temperature	10 s or less
Time of temperature higher than 210°C	30 s or less
Preheating time at 100°C to 160°C	60 to 120 s
Maximum chlorine content of rosin flux (percentage mass)	0.2% or less

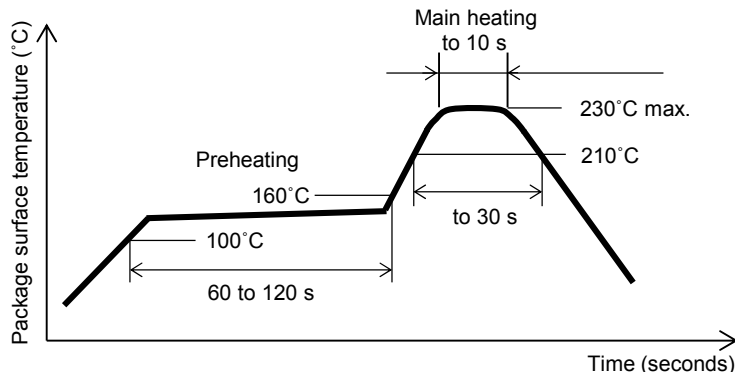


Figure 4.17 Infrared Reflow Temperature Profile (IR30)

c. IR reflow 235°C (IR35)

The table below lists the soldering heat resistance conditions (IR35) for IR reflow.

Table 4.16 Heat Resistance Conditions (IR35)

Maximum temperature (package's surface temperature)	235°C or below
Time at maximum temperature	10 s or less
Time of temperature higher than 210°C	30 s or less
Preheating time at 100°C to 160°C	60 to 120 s
Maximum chlorine content of rosin flux (percentage mass)	0.2% or less

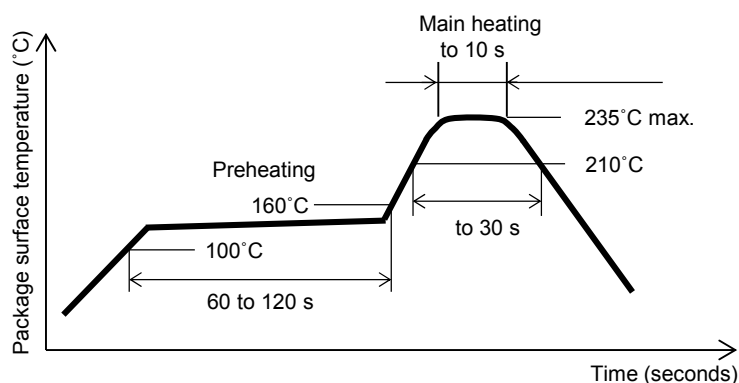


Figure 4.18 Infrared Reflow Temperature Profile (IR35)

d. IR reflow 250°C (IR50)

The table below lists the soldering heat resistance conditions (IR50) for IR reflow.

Table 4.17 Heat Resistance Conditions (IR50)

Maximum temperature (package's surface temperature)	250°C or below
Time at maximum temperature	10 s or less
Time of temperature higher than 220°C	60 s or less
Preheating time at 160°C to 180°C	60 to 120 s
Maximum chlorine content of rosin flux (percentage mass)	0.2% or less

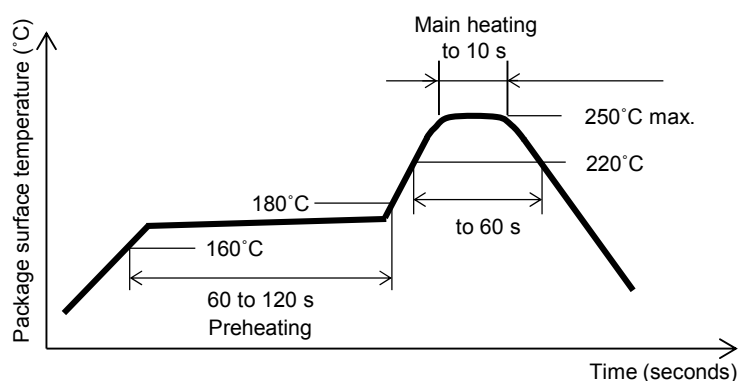


Figure 4.19 Infrared Reflow Temperature Profile (IR50)

e. IR reflow 260°C (IR60)

The table below lists the soldering heat resistance conditions (IR60) for IR reflow.

Table 4.18 Heat Resistance Conditions (IR60)

Maximum temperature (package's surface temperature)	260°C or below
Time at maximum temperature	10 s or less
Time of temperature higher than 220°C	60 s or less
Preheating time at 160°C to 180°C	60 to 120 s
Maximum chlorine content of rosin flux (percentage mass)	0.2% or less

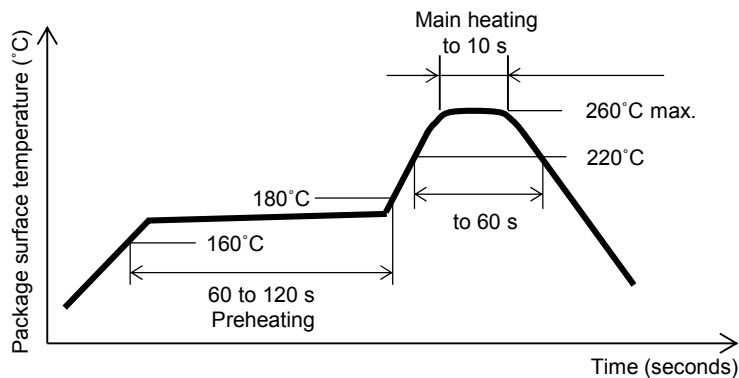


Figure 4.20 Infrared Reflow Temperature Profile (IR60)

f. VPS reflow (VPS)

The table below lists the soldering heat resistance conditions (VPS) for VPS reflow.

Table 4.19 Heat Resistance Conditions (VPS)

Maximum temperature (package's surface temperature)	215°C or below
Time of temperature higher than 200°C	25 to 40 s
Preheating time at 120°C to 150°C	30 to 60 s
Maximum chlorine content of rosin flux (percentage mass)	0.2% or less

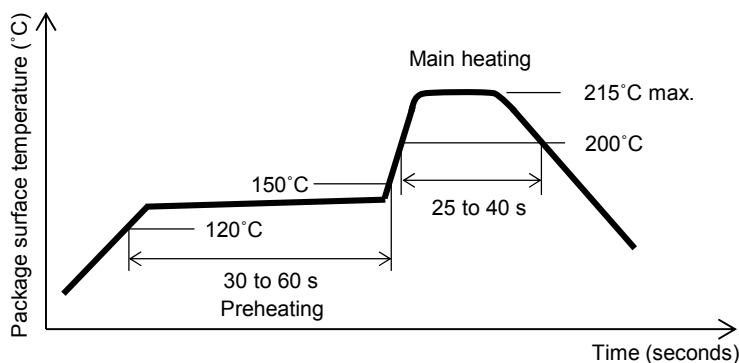


Figure 4.21 VPS Reflow Temperature Profile

g. Wave (jet) soldering (WS)

The table below lists the soldering heat resistance conditions (WS) for wave (jet) soldering.

Table 4.20 Heat Resistance Conditions (WS)

Maximum temperature	260°C (molten solder temperature)
Flow soldering time	10 s or less
Preheating conditions	120°C or below (package surface temperature) No time limit
Times	Once

h. Partial heating

The table below lists the soldering heat resistance conditions for partial heating.

— Products inserted in the board

Table 4.21 Heat Resistance Conditions (Partial Heating)

Maximum temperature	300°C or below (temperature of pins)
Time	3 s or less (per one pin)
Flux	Rosin flux with minimal chlorine content (chlorine(percentage mass): 0.2% or less)

Note: The peak temperature is 300 or 350°C, depending on the product.
For details, consult a Renesas Electronics sales representative.

— Products mounted on the board

Table 4.22 Heat Resistance Conditions (Partial Heating)

Maximum temperature	300°C or below (temperature of pins)
Time	3 s or less (per one side)
Flux	Rosin flux with minimal chlorine content (chlorine(percentage mass): 0.2% or less)

Note: The peak temperature is 300 or 350°C, depending on the product.
For details, consult a Renesas Electronics sales representative.

4.3.3 Soldering Temperature

The reflow soldering temperature must be managed so that the package body temperature remains under its heat resistance temperature. The ideal temperature conditions are those such that the package contacts and pins enter the recommended temperature range for the solder paste used.

Since the preheating temperature and time and the main soldering temperature and time will differ depending on the composition of the solder used and the characteristics of the flux, these must be verified in advance.

Note that the composition of the package contacts and pins involves processing with multiple metallic compositions as discussed in section 4.3.4. Therefore, the melting temperature of the platings used on the package contacts and pins must also be taken into consideration. Process condition settings such that the solder used for mounting and the package contact metal and pin plating metal fuse together are ideal.

Also note that the soldering atmosphere (nitrogen atmosphere) is an item that has a large effect and influence on the soldering time and temperature and must be taken into consideration when analyzing the process condition settings.

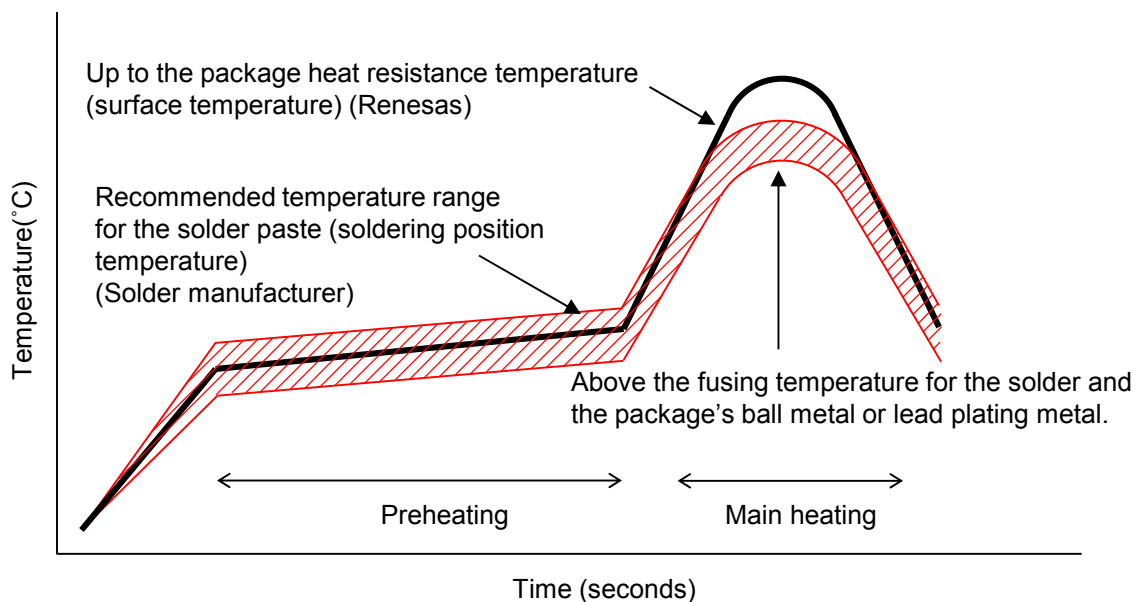


Figure 4.22 Soldering Temperature

4.3.4 Package Contact and Pin Plating Metal Compositions

The table below lists common contact and pin plating compositions and their melting points.

We recommend taking these values into consideration when selecting the solder paste and when setting the reflow temperature profile, in particular, consider setting the soldering conditions to be higher than the melting temperature of the contact material.

Table 4.23 Contact and Pin Plating Compositions and Melting Temperatures

Package Pins	Contact and Pin Plating Composition	Melting Temperature
Ball pins (e.g. BGA)	Sn-37Pb	183°C
	Sn-3Ag-0.5Cu	217 to 220°C
Lead pins (e.g. QFP)	Sn-10Pb	183 to 216°C
	Sn-1.5Cu	227°C
	Sn-2.0Bi	217 to 227°C
	Sn	232°C
	Ni/Pd/Au	(Fusible plating)

4.3.5 Notes on Solder Shorts and Opens

(1) Solder Shorts

Solder shorts may occur due to the following causes.

- Displacement of the solder paste printing position and excessive solder paste.
- Positional displacement of the package onto the printed wiring board during mounting
- In addition, we recommend optimizing the soldering temperature profile for the packages and printed wiring board used as a means of preventing solder shorts.

(2) Solder Opens

Due to inadequate surface activation of the product package contacts (BGA: solder balls, QFP: lead plating), phenomenon such as failure of the solder paste to fuse to the product package contacts may occur. This may occur due to the following causes.

- Degradation of the solder paste wetting activation ability
- Inadequate solder paste volume applied in printing
- Problems with the reflow soldering conditions (temperature profile, reflow atmosphere)
- Warping of product packages or the printed wiring board during reflow soldering

We recommend that users optimize the solder paste materials used, the stencil specifications, and the reflow soldering conditions (temperature profile, reflow atmosphere).

4.4 Temperature Conditions on Second Reflow

When applying the heating for flow or reflow soldering a second time, either for two sided mounting or for repair, problems such as solder shorts and device peeling may occur in some cases.

The following points must be considered when setting the process conditions.

- If moisture is absorbed, the warping characteristics of BGA packages and the printed wiring board itself may change. Products must be managed to prevent moisture absorption between reflow operations.
- The flux and reflow atmosphere used must be optimized to assure solder spreading during remelting.
- The process must be optimized to assure that the package contacts do not excessively exceed the solder melting point. Note that setting the temperature to a point below the solder melting point should also be considered.

4.5 Mechanical Strength of Soldered Sections After Mounting

After mounting, soldered components can be peeled away by the application of mechanical force. Products and their manufacturing processes must be designed only after first verifying the stresses that occur not only in manufacturing, for example the stresses when printed wiring boards are separated or are inadvertently dropped, but also in the handling environment they are subject to in the market.

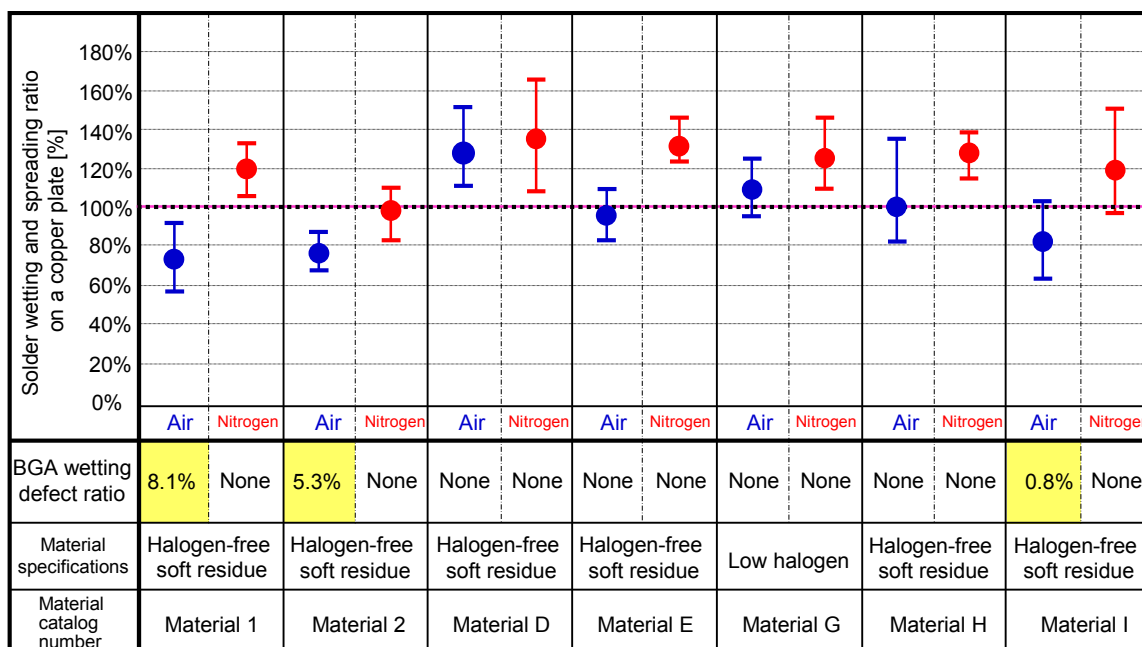
5. Examples of Mounting and Problems

5.1 BGA Mounting Process

This section presents notes on solder mounting and examples of problems in solder mounting based on the BGA mounting case.

5.1.1 Notes on Lead-Free Solder Mounting

Differences in the wetting and spreading characteristics of the various lead-free solder (Sn-3Ag-0.5Cu) materials on copper plates have been recognized. Materials that result in an area smaller than the area printed with the solder paste are also seen occasionally when reflow is performed in air. Furthermore, materials with differences in wetting and spreading have also been recognized when reflow is performed in a nitrogen atmosphere. (See figure 5.1.) To acquire stable solder wetting characteristics, careful selection of the solder materials and optimization of the reflow process conditions are required.



Reflow soldering conditions
 Peak temperature: 235°C
 Time below 220°C: 35 s
 Atmosphere (1) Air
 (2) Nitrogen (Oxygen density: 300±30 ppm)

Solder wetting and spreading ratio (%) = $\frac{\text{Area after reflow (R)}}{\text{Area after printing (S)}}$

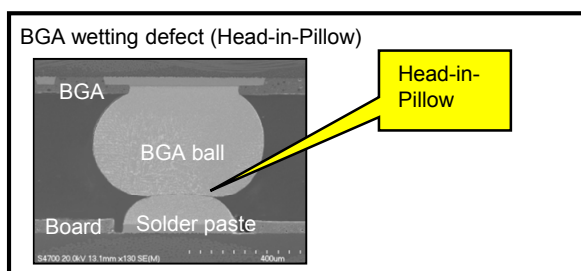


Figure 5.1 Solder Paste Material Wetting and Spreading

5.1.2 Notes on WLBGA Usage

Extreme care is required in handling these products since the chip is not protected by resin.

1. Use vacuum tweezers to move these products.

Use of metal tweezers to handle these products can chip the silicon chip.

2. Use extreme care to prevent applying mechanical shocks to these products to prevent chipping or cracking of the silicon chip.

Chipping or cracking can occur if boards are stacked after mounting.

3. These chips must be handled only in environments in which anti-static measures have been implemented to prevent damage from static discharge.

4. If underfilling is performed after mounting, form a fillet of at least 50% of the devices thickness* along each side of the device.

If the fillet is insufficient, peeling may occur in the rewiring layers, including the silicon chip and resin section.

Note: * Device thickness: the rewiring layers including the silicon chip plus resin section.

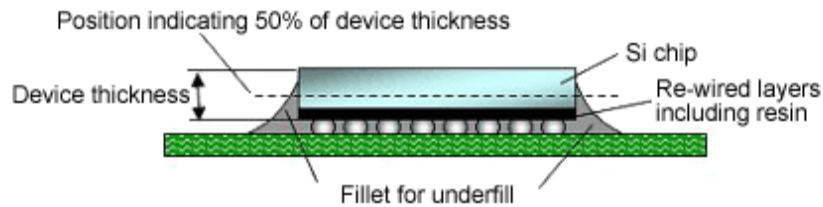


Figure 5.2 Underfill Applied State

5. For other conditions, use the same handling as other semiconductor devices.

5.1.3 Mounting Example (WLBGA)

(1) Evaluation Package

- 5.17×5.17 mm, 100-pin WLBGA, 0.5 mm pitch
- Silicon thickness: 0.33 mm, resin thickness: 0.07 mm
- Solder ball diameter: 0.3 ± 0.05 mm, ball height: 0.24 ± 0.05 mm
- Copper post diameter: 0.28 mm

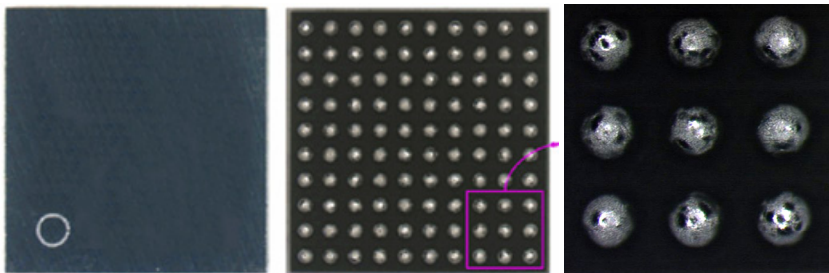


Figure 5.3 External Appearance of the 5.17×5.17 mm, 100-pin WLBGA Package

(2) Board Specifications

- Double-sided built-up 4-layer board, 1/2/1 (core: FR = 4, t = 0.6 mm)
- Board size: 40 × 110 × t 0.8 mm
- Pad structure/dimensions: NSMD/pad diameter = 0.28 mm, SR aperture diameter = 0.35 mm
- Pad surface processing: non-electrolytic Ni/Au flash plating

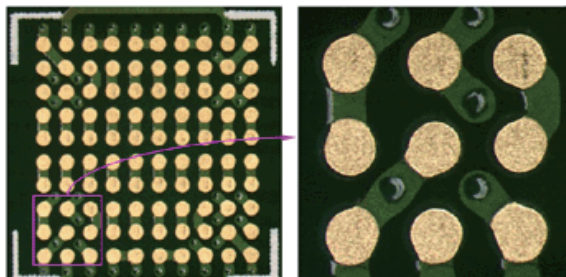


Figure 5.4 External Appearance of the Package Mounting Area Pads

The pad diameter is set to match the ball contact diameter (copper post diameter) on the package. This is so that stresses after mounting will be distributed evenly over the solder joints area.

The NSMD structure is used for the pad structure unless there is a particular reason for another structure. The NSMD structure improves the thermal cycle characteristics more than SMD. However, for the NSMD structure, it is easy for wire breakage due to mechanical stress to occur in the areas where the leads intersect with the SR aperture area. Therefore a teardrop shape is used and the lead width in those areas is made as wide as possible.

Although the via holes are provided near the pads, if connection routing is difficult, it may be necessary to use a pad on via arrangement.

Either non-electrolytic Ni/Au flash plating or a heat-resistant preflux is used for the pad surface processing.

(3) Stencil Specifications

- Aperture diameter: 0.28 mm, thickness = 120 μm

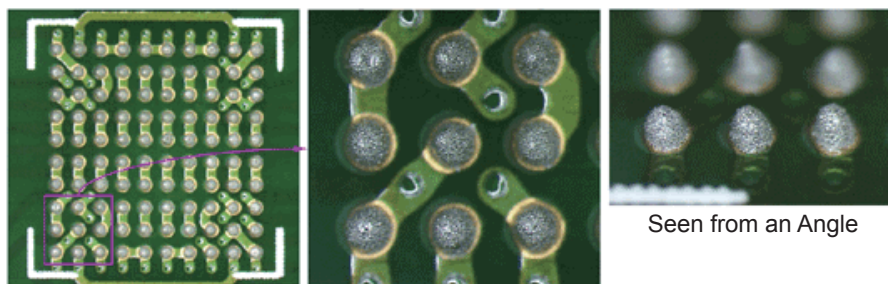


Figure 5.5 External Appearance after Solder Printing

The stencil aperture diameter is made to match the board pad diameter.

There should be no problems in mountability if the stencil thickness is 100 μm.

(4) Solder Paste

- Sn-3Ag-0.5Cu, solder particle diameter: 15 to 25 μm. Flux: No-wash RMA type.

Use a solder paste with good printability.

(5) Package Recognition and Placement

- Placement equipment: Multifunction mounter with visual recognition. Shape recognition is used for package recognition.

Both ball recognition and shape recognition can be supported as the recognition method.

(6) Reflow Soldering Conditions

- Reflow soldering after preprocessing.
125°C/10 hours bake → package moisture absorption for 168 hours at 30°C/70%RH → Reflow soldering at 260°C × 3 times.

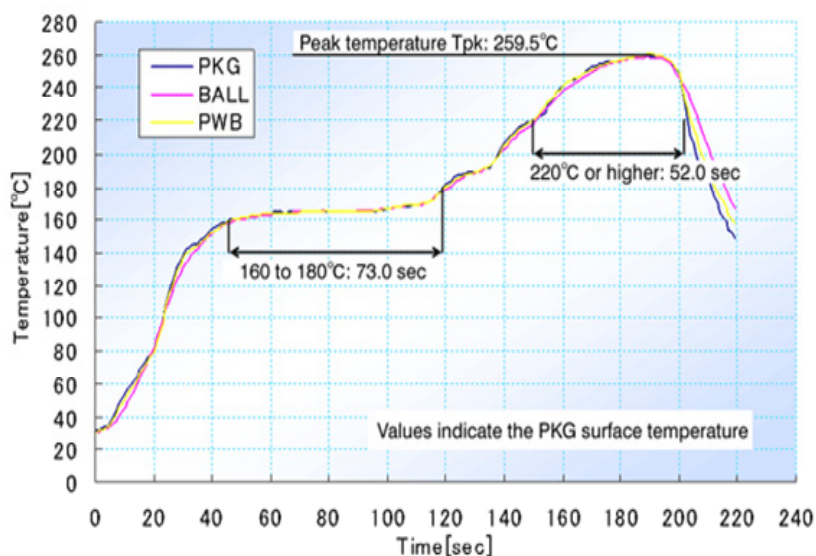


Figure 5.6 Reflow Soldering Temperature Profile

While the preprocessing was performed in this evaluation, the bake operation is not required since this package is dry packing free product.

Although this evaluation used mounting at 260°C, in mass production, mounting should be performed within the recommended usage temperature conditions range for the solder paste actually used.

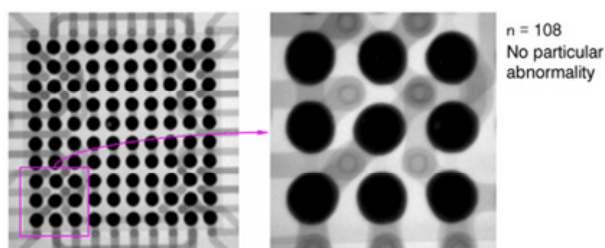
(7) Mountability Verification

Figure 5.7 Post-Mounting X-Ray

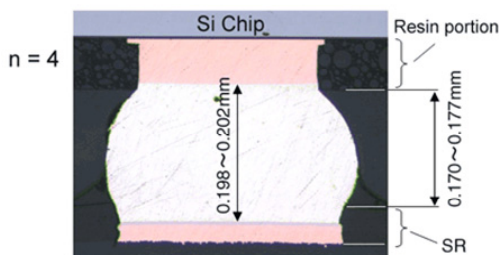


Figure 5.8 Post-Mounting Cross Section

5.1.4 Examples of Problems in BGA Mounting

When preventing the occurrence of mounting problems and when resolving or improving such problems, it is important to know the behavior of the solder joint during reflow heating. Figure 5.9 shows a good solder joint formation example for a BGA package when the BGA package joint process is viewed with a high-temperature observation unit. In this example, when the main heating (above the melting point) phase is entered and the solder paste fuses, the solder starts to wet move up the balls, and when all the balls have fused, the device starts to sink. To acquire good joining, it is important to set the time above the melting point appropriately so that the devices adequately sink into the solder. In this example, about 20 seconds is required for the package to sink adequately.

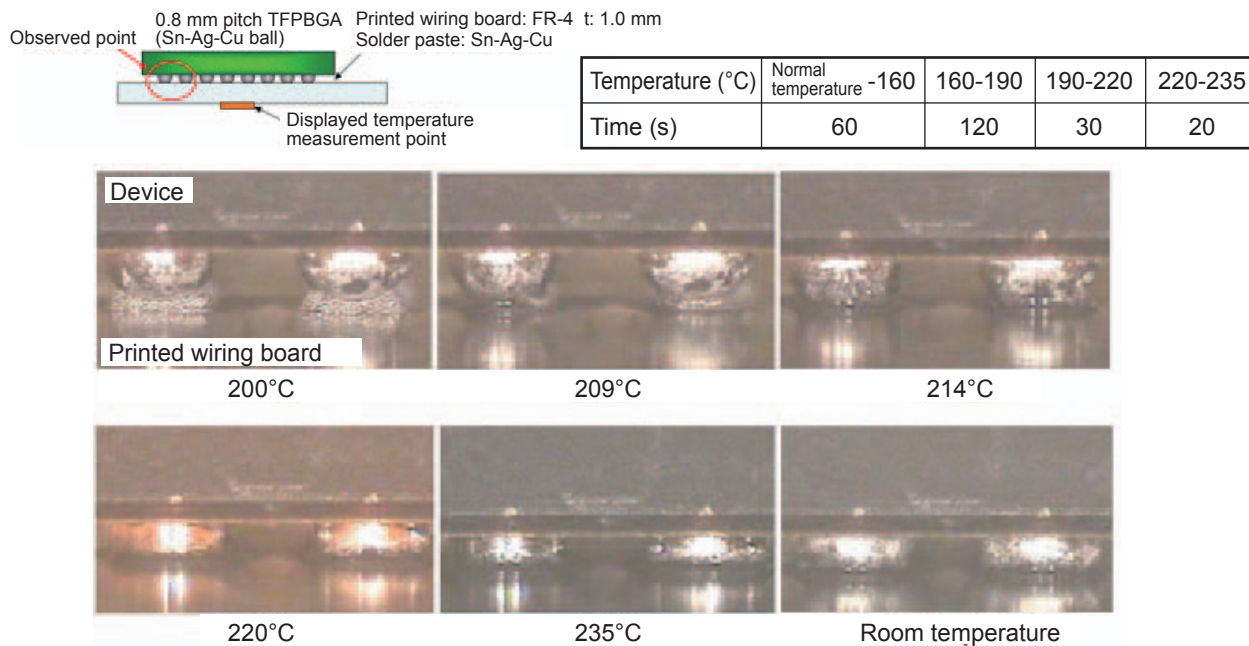


Figure 5.9 Good BGA Joint Formation Process

(1) Problem Case 1: Insufficient Heating

Figure 5.10 shows a problem case that is due to insufficient heating in the BGA package joint formation process. This is an example of changing the heating conditions and observing the joint external appearance and cross section.

If the peak temperature is low and the time above the melting point is short, either the solder paste and solder ball may not melt and thus not fuse together (condition 1) or even if they do melt, the shape of the solder joint may be poor and the standoff may remain excessive (condition 2).

As the peak temperature becomes higher and the time above the melting point becomes longer, the solder joint shape improves (condition 3), and with appropriate conditions set, a good solder joint shape is acquired (condition 4).

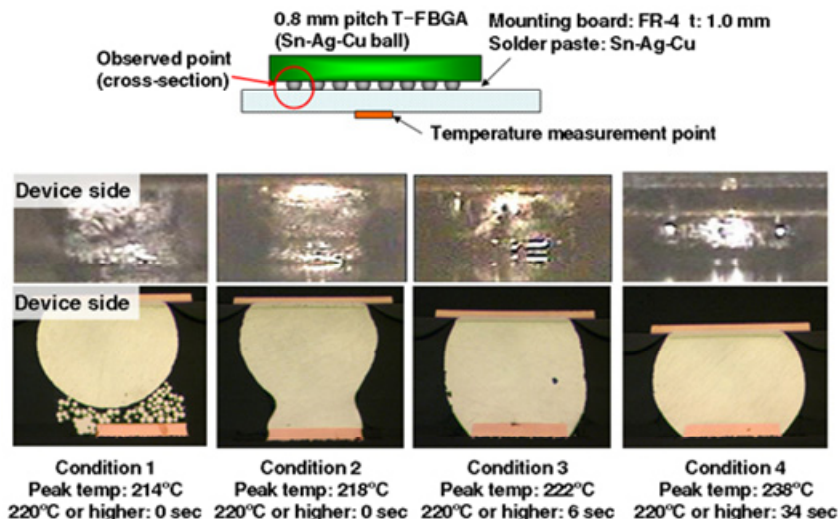


Figure 5.10 Heating Conditions and Solder Joint State

(2) Problem Case 2: Head-in-Pillow

1. What does it mean for the Head-in-Pillow?

When mounting BGA packages, a phenomenon in which the solder paste and solder ball do not fuse together may occur as shown in figure 5.11. In this failure to Head-in-Pillow, the solder ball and the solder paste are in a state where they are not fused. Even in this state, however, the joint may be electrically conductive in initial post-mounting testing.

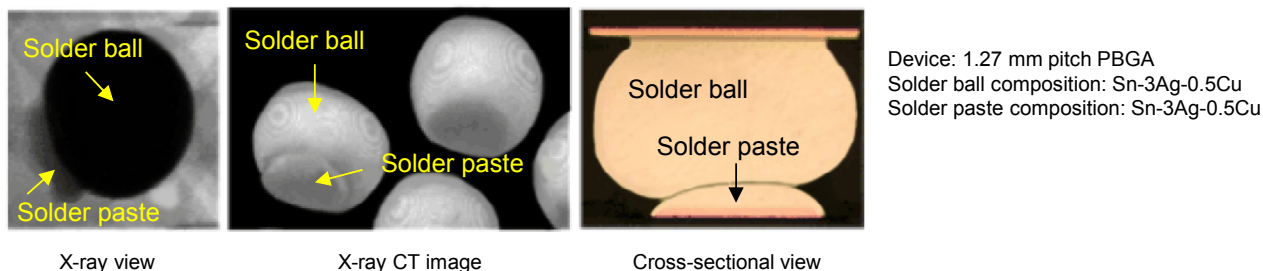


Figure 5.11 Example of Solder Ball Failure to Head-in-Pillow

2. Inferred mechanism for failure to fuse faults

Figure 5.12 shows the mechanism for the failure to Head-in-Pillow. When the package or the printed wiring board is heated, warping occurs. If this warping is large, the solder ball and solder paste will be pulled apart (the preheating process in the figure). If heating continues in this state, the solder ball will be subjected to high heat and surface oxidation proceeds rapidly (the main heating process). At this time, although flux seeps out from the solder paste and covers the surface, if this flux loses its activity, when the warping is reversed during the cooling process, even if the solder ball makes contact, the flux cannot remove the oxide film from the solder ball surface, and a failure to Head-in-Pillow occurs (cooling process).

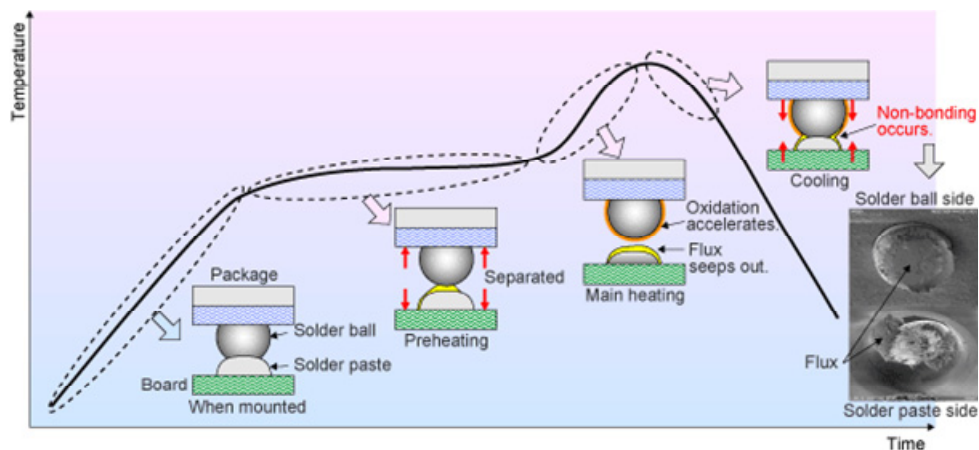
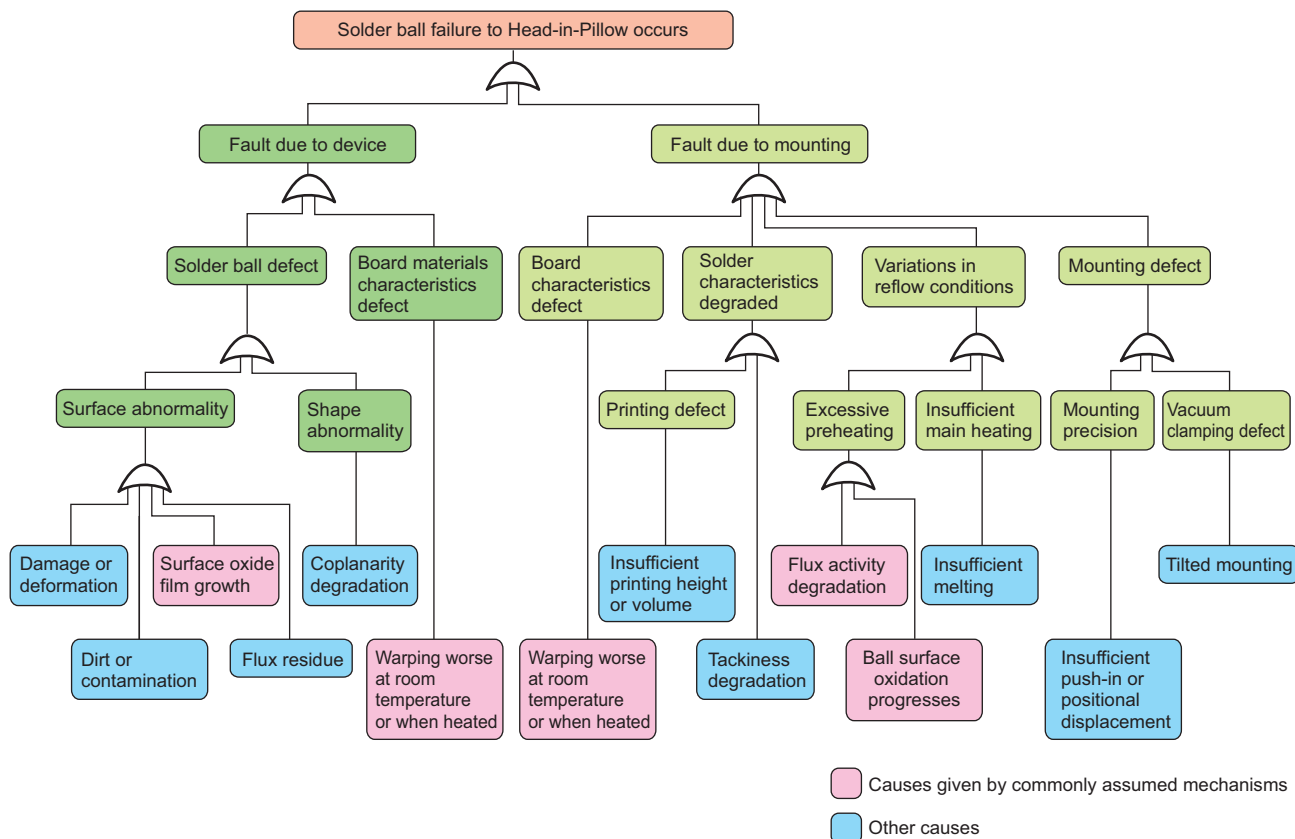


Figure 5.12 Assumed Mechanism for the Failure to Head-in-Pillow

3. Analysis of Failure to Fuse Fault Causes

In addition to the cause discussed in the assumed mechanism section, several other factors may cause failure to Head-in-Pillow to occur. Figure 5.13 presents a fault tree analysis (FTA) for package and mounting factors. It is thought that failure to Head-in-Pillow can occur do to individual causes occurring or to combinations of multiple causes.



Causes given by commonly assumed mechanisms
 Other causes

Figure 5.13 Fault Tree Analysis for Failure to Head-in-Pillow

4. Failure to Head-in-Pillow Causes and the Mounting Margin

Figure 5.14 shows a conceptual overview of the failure to fuse causes and the mounting margin. When the danger of failure to fuse faults occurring increases with one or multiple of these causes occurring, the mounting margin is reduced. If this danger increases further, the mounting margin may be lost, leading to failure to fuse faults.

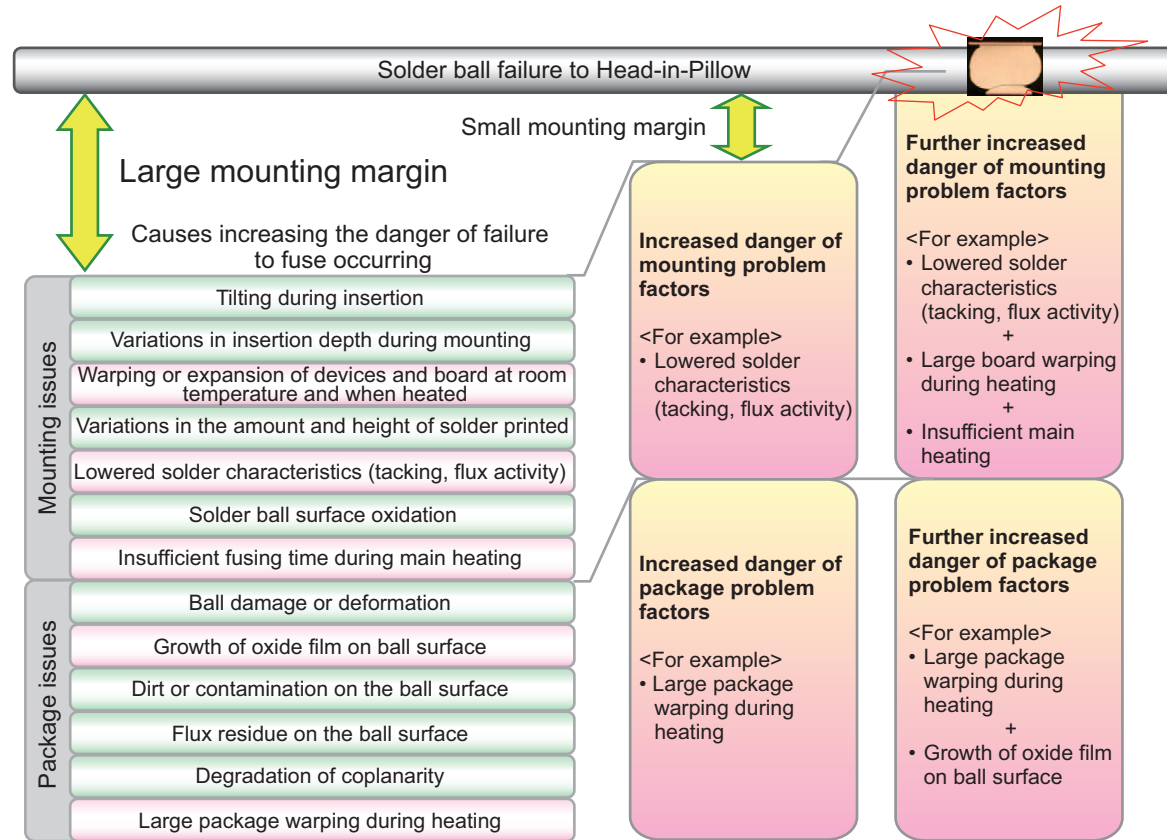


Figure 5.14 Failure to Head-in-Pillow Causes and the Mounting Margin

Next, we present examples of methods for resolving this problem.

Factor 1: BGA package/printed wiring board warping

Warping occurs when a BGA package or printed wiring board is heated. When the amount of warping is large, or when the directions of warping are opposite, the spacing at the solder joints increases, the solder ball and solder paste become separated, and failure to Head-in-Pillow may occur.

- Problem case: warping cause and inferred failure to Head-in-Pillow

Figure 5.15 shows the result of studying the warping in mounting defect products where failure to Head-in-Pillow occurred. In this example, concave warping can be seen in both the BGA package and the printed wiring board in the BGA package mounting area. Here, failure to fuse faults occur at the places where the warping separation between the BGA package and the printed wiring board is the largest at the center of the D side.
- Workarounds
 1. BGA package and printed wiring board storage

Warping becomes larger when BGA packages and printed wiring boards absorb moisture. If moisture absorption occurs, bake these item under the stipulated conditions.
 2. Printed wiring board and the mounting layout

Since warping can be promoted by the printed wiring board materials, structure, wiring, shape, and mounting layout, verify the warping behavior at room temperature and when heated. If there is large warping when heated, consider implementing a warp prevention jig.

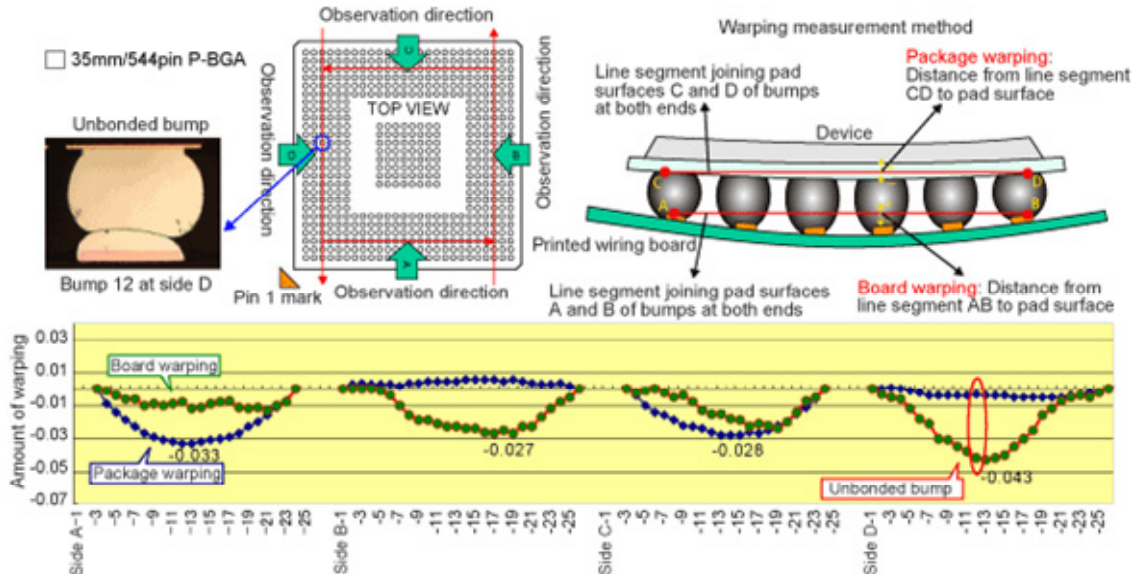
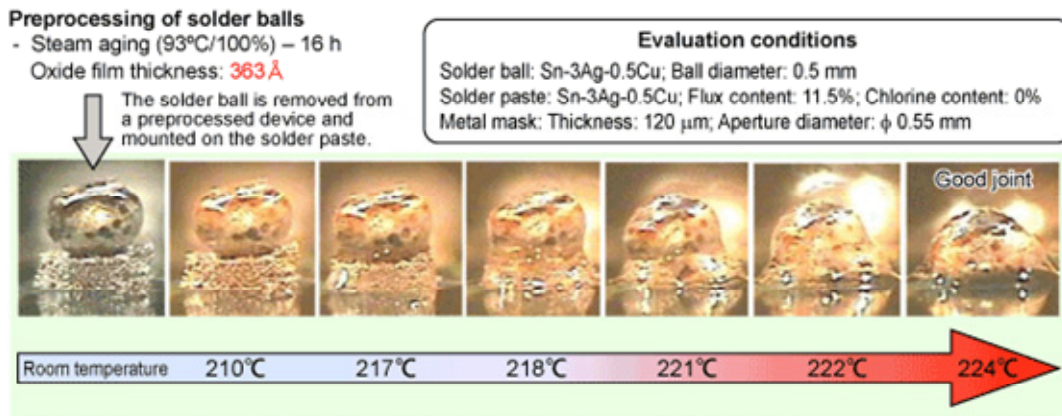


Figure 5.15 Example of Failure to Head-in-Pillow Due to Warping

Factor 2: Solder ball surface oxide film

Since, if packages are left standing for a long period after opening the moisture-proof packing, oxide film formation on the solder ball will progress and the oxide film become thicker, this can be thought to be a cause of the occurrence of failure to Head-in-Pillow. Although we verified that even if the oxide film on the solder balls becomes somewhat thicker due to the preprocessing, its influence on solderability is not significant, as shown in figure 5.16, if some other factors are combined with this (for example, if the oxide film on the solder balls grows rapidly during reflow heating or if the BGA package or printed wiring board warps), its influence on failure to Head-in-Pillow may be heightened.

- Reproducibility evaluation example: Solderability of solder ball oxide film thickness and solder paste.
 In this example, even for solder balls on which preprocessing has been performed and the surface oxide film has become thicker, good bonding was obtained.



Note The temperatures indicated above indicate the stage temperature(that is, the temperature on the back of the printed wiring board) and differ slightly from the temperatures of the soldered part.

Figure 5.16 Solderability of Solder Balls with Thick Surface Oxide Film

- Workarounds

- BGA package storage

Reduce the temperature and humidity in the storage environment after the moisture-proof packing has been opened as much as possible within the range of conditions stipulated for the product (for example under 30°C and under 70%RH).

Also, when storing opened products, avoid leaving stand unnecessarily and consider repacking in moisture-proof packing.

- Optimize the temperature profile and use a solder paste with high activity

There is a close relationship between reflow temperature profile optimization, surface oxidation of solder balls that use high activity solder paste, and flux activity. Therefore, use a temperature profile that optimizes the activity when melted of the solder paste used. Also note that solder paste with a high activity can suppress the growth of oxide film on the solder balls during reflow heating.

- Workarounds for BGA package and printed wiring board warping

The separation of the solder balls and solder paste during reflow hinders the removal of oxide film and suppression of reoxidation of the solder ball surface by the flux, and thus promotes solder ball surface oxidation. Thus, it is important to consider suppressing warping by package moisture absorption countermeasures, printed wiring board moisture absorption countermeasures, and reviewing the mounting layout.

Factor 3: Reduced flux activity

The flux activity can be reduced if the preheating time is longer, or the temperature higher, than the solder paste manufacturer's recommended conditions, and this can lead to degradation of solder ball to solder paste solderability.

- Reproducibility evaluation example: solderability of solder ball and solder paste with reduced activity

Figure 5.17 shows an example of mounting between solder balls and solder paste with radically reduced activity observed while heating. As the heating proceeds, the flux in the solder paste oozes from the surface and goes no further than the state where the solder balls appear to be lifted. We think that when flux loses its activity, it prevents joining and leads to failure to Head-in-Pillow.

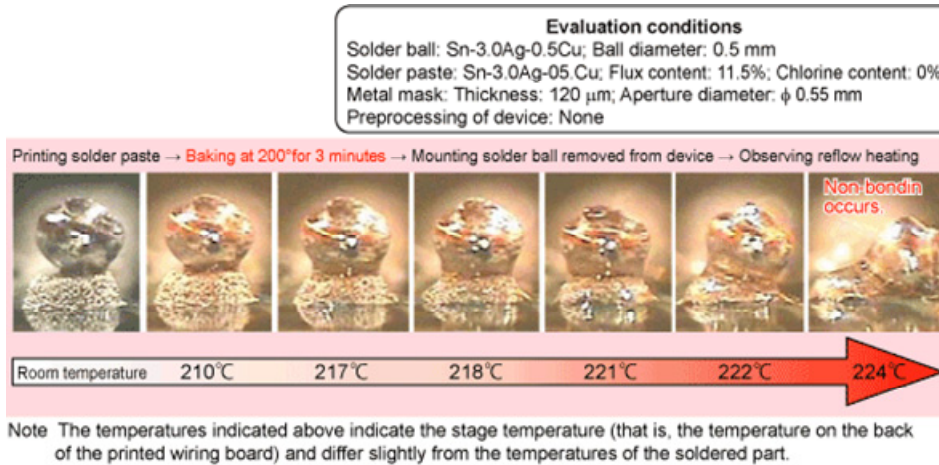


Figure 5.17 Joint Formed by Reduced Activity Solder Paste

• Workarounds

1. Verify the solder paste storage conditions

Verify that you are observing all usage notes provided by the manufacturer of the solder paste used in the storage environment and storage conditions.

2. Review the reflow temperature profile

Verify that the process conditions are within the recommended conditions for the solder paste used at the BGA package solder joints.

3. Change the reflow atmosphere

Reflow heating in a nitrogen atmosphere has a large effect in preventing solder ball surface oxidation.

4. Change the solder paste used

Figure 5.18 shows a case where we implemented a failure to fuse reproducibility evaluation under identical conditions for twenty types of solder paste that can be easily purchased in Japan. Here, we saw a difference of about a factor of 20 between the solder paste with the low failure to Head-in-Pillow occurrence ratio (solder paste type 1) and the solder paste with the high failure to Head-in-Pillow occurrence ratio (type 20). That is, the type of the solder paste caused this large difference. We recommend performing an evaluation under the mounting conditions you will be using and selecting a solder paste with a low failure to Head-in-Pillow occurrence ratio.

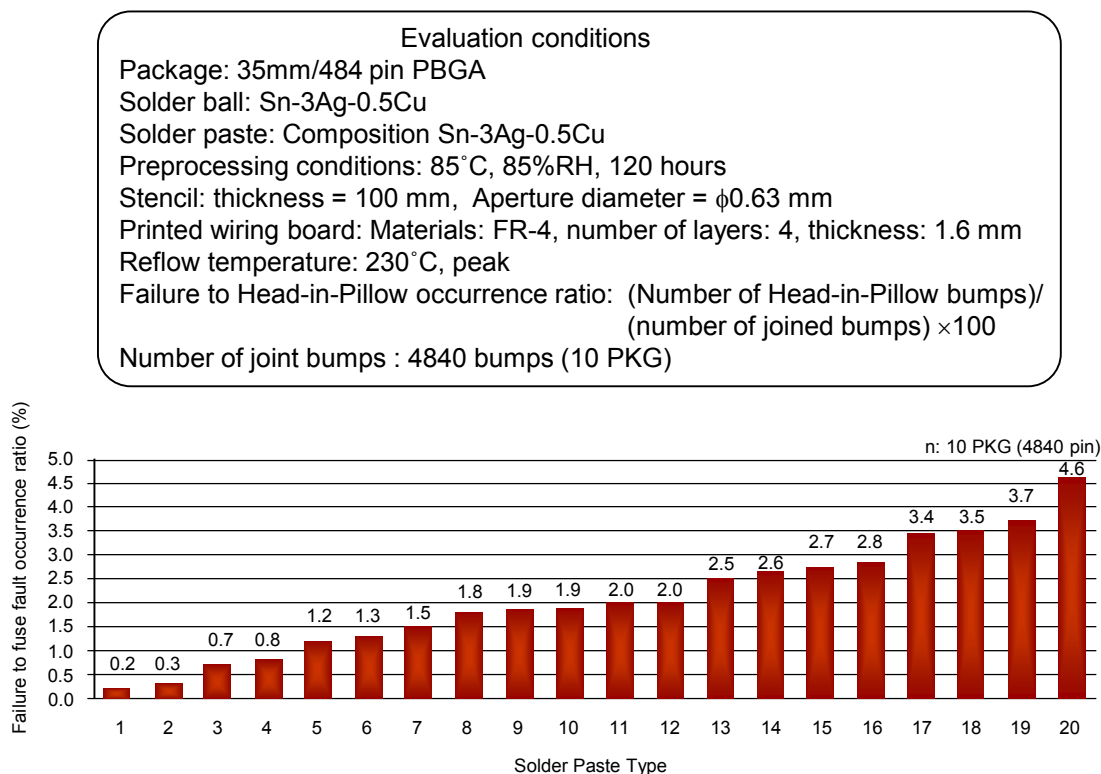


Figure 5.18 Solder Paste Types and Failure to Head-in-Pillow Occurrence Ratios

Factor 4: Insufficient main heating time

If the solder paste and solder ball are separated during heating, the oxidation of the solder ball surface will proceed. When the solder melting point has been exceeded, and the melted solder paste contacts a solder ball, if the flux activity has become weaker, it is thought that the solder ball surface oxide film will not be quickly broken.

- Reproducibility evaluation example: Time above the melting point and joinability

Figure 5.19 shows the result of a reproducibility evaluation under the conditions where the solder paste and solder balls are held apart until the melting point is reached and then brought into contact at the point the melting point is exceeded. In this state, failure to Head-in-Pillow were observed to occur when the heating time above the melting point was kept short (about 6 s). (See the top figure.)

Under the same conditions, however, if the heating time above the melting point was extended (about 30 s), then good joints such as those shown in the lower figure were acquired.

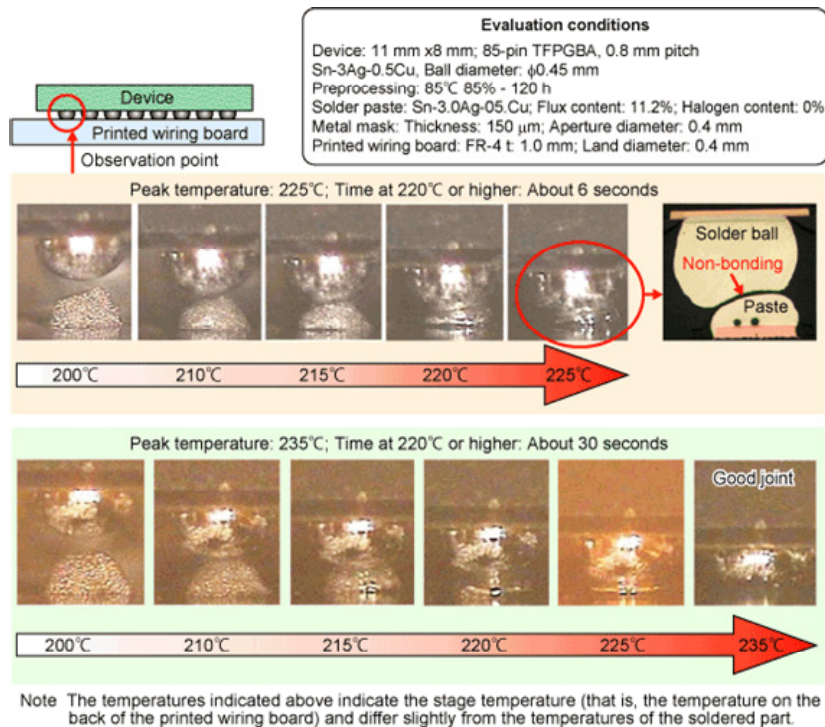


Figure 5.19 Time Above Melting Point and Solderability

• Workarounds

1. Review the reflow temperature profile

There are cases when failure to fuse faults occur if the time above the melting point is short. If the time above the melting point is made longer, as shown in figure 5.20, it is possible that the failure to Head-in-Pillow occurrence ratio may be reduced. Thus keeping the time above the melting point as long as possible is effective.

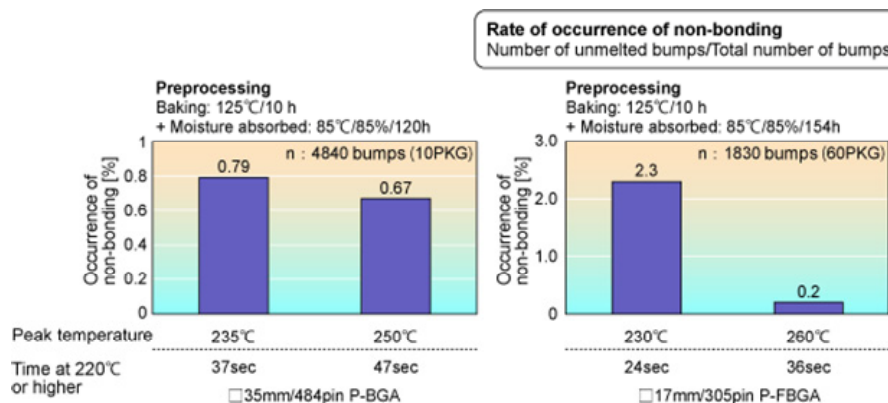


Figure 5.20 Time Above Melting Point and Failure to Head-in-Pillow Occurrence Ratio

(3) Fault Example 3: Solder Joints Separation (Ball Drop)

1. Solder joints separation (ball drop)

The characteristics of the solder joints separation (ball drop) fault are that the area where the solder ball contacts the BGA land (or the pad on the mounting board) appears rounded on inspection of the cross section of the solder joint area and appears as though the ball is falling. There is also a tendency for this fault to occur in the balls in the inner periphery of the ball array. Figure 5.21 shows an example of the ball drop phenomenon that has occurred between the solder ball and the BGA land.

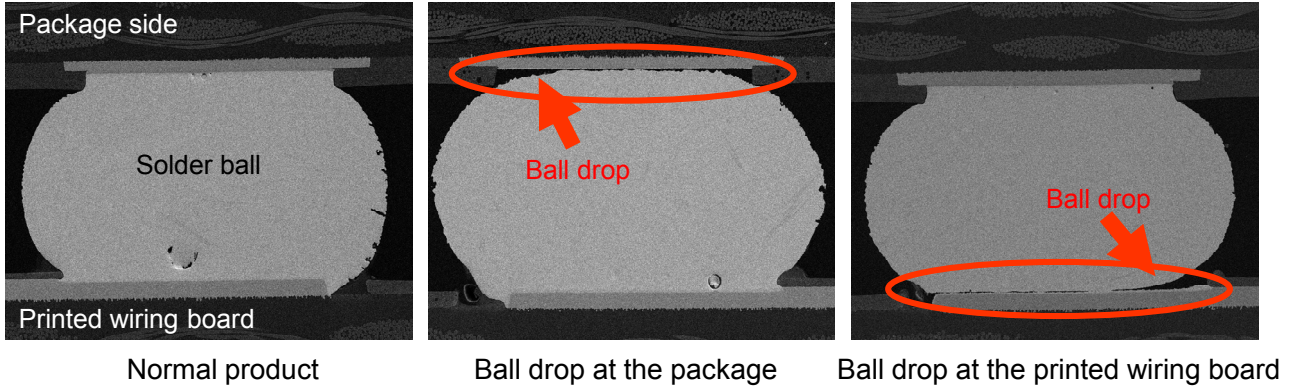


Figure 5.21 Ball Drop Joint Cross Sectional Form Observation Example

2. Ball drop occurrence mechanism

The following mechanism may be responsible for creating the ball drop phenomenon on a second reflow operation, even though a normal joint is formed by the first reflow operation. On the second reflow operation, the solder ball is melted from the outside. If any warping has occurred in the package or the printed wiring board, when stress is applied in the direction in which the joints interval spreads, this force is concentrated on the solder balls in the central area that are not yet melted. In this state, when the solder balls in the central area change from the solid phase to the solid plus liquid phase region, the joint loses its constraining force and at that instant separation occurs near the intermetallic compound (IMC) on the copper land. It is inferred that, after that, melting of the solder ball progresses and the solder ball takes on a rounded shape that appears as though it is dropping.

Package and/or printed wiring board warping may increase during reflow soldering if either the package or printed wiring board absorbs moisture between the first and second reflow operations, or if the reflow temperature is high. As a result, the frequency of ball drop occurrence may increase in these cases.

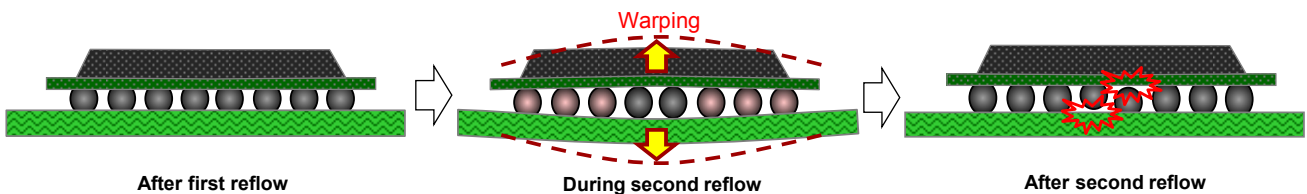


Figure 5.22 Assumed Ball Drop Occurrence Mechanism

3. Workarounds

Consider the following methods as workarounds to prevent the ball drop phenomenon from occurring.

1. Avoid remelting after mounting: Only perform one reflow soldering operation on packages for which ball drop occurs (i.e. mount such packages during the second reflow operation). Also, avoid performing reflow soldering again during repairs.
2. Reflow atmosphere: If atmospheric reflow is used, switch to N₂ (nitrogen) reflow soldering, which provides improved solderability.
3. Prevent moisture absorption: When multiple reflow operations are performed, store packages and printed wiring boards so that they do not absorb moisture from the first reflow operation until the last reflow operation.
4. Reduce the reflow temperature: For packages for which multiple reflow operations are performed, reduce the reflow temperature for the second and later reflow operations to the low end of the acceptable range.

5.2 LGA Mounting Process

This section presents notes on solder mounting and examples of problems in solder mounting based on the LGA mounting case.

5.2.1 Mounting Case (FLGA)

(1) Evaluation Package

- 5 × 5 mm, 64-pin FLGA, 0.5 mm pitch

(2) Board Specifications

- FR-4, 4-layer board
- Board size: 40 × 110 × 0.8 mm
- Pad structure/dimensions: NSMD, pad diameter = 0.3 mm, SR aperture diameter = 0.35 mm
- Pad surface processing: heat-resistant preflux

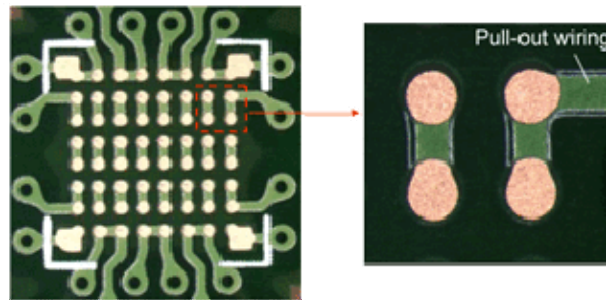


Figure 5.23 Visual Appearance of Package Mounting Area and Pad Area

The copper land diameter is set to match the package land diameter. This is so that stresses after mounting will be distributed evenly over the solder joints area.

The NSMD structure is used for the pad structure unless there is a particular reason for another structure. The NSMD structure improves the thermal cycle characteristics more than SMD. However, for the NSMD structure, it is easy for wire breakage due to mechanical stress to occur in the areas where the leads intersect with the SR aperture area. Therefore a teardrop shape is used and the lead width in those areas is made as wide as possible.

(3) Stencil Specifications

- Aperture diameter: 0.3 mm, thickness = 110 μm (stencil: additive)

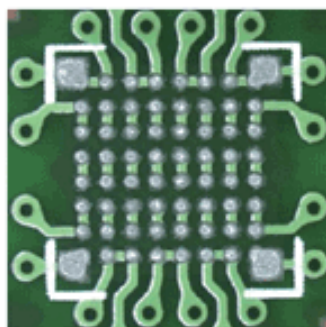


Figure 5.24 Appearance After Solder Printing

The stencil thickness is set to be in the 100 to 120 μm range and the stencil aperture diameter is matched to the board land diameter. Note, however, if the board and packages are easily warped, the aperture diameter is enlarged to about 1.2 times the package land diameter.

(4) Solder Paste

- Sn-3Ag-0.5Cu, solder particle diameter: 20 to 36 μm . Flux: No-wash RMA type.

Use a solder paste with good printability.

(5) Package Recognition and Placement

- Placement equipment: Multifunction mounter with visual recognition. Shape recognition is used for package recognition.

Since the land shapes are not the same, shape recognition can be used as the FLGA recognition method.

(6) Reflow Soldering Conditions

- Reflow soldering after preprocessing.

125°C/10 hours bake → package moisture absorption for 168 hours at 30°C/70%RH → Reflow soldering at 240°C, once only.

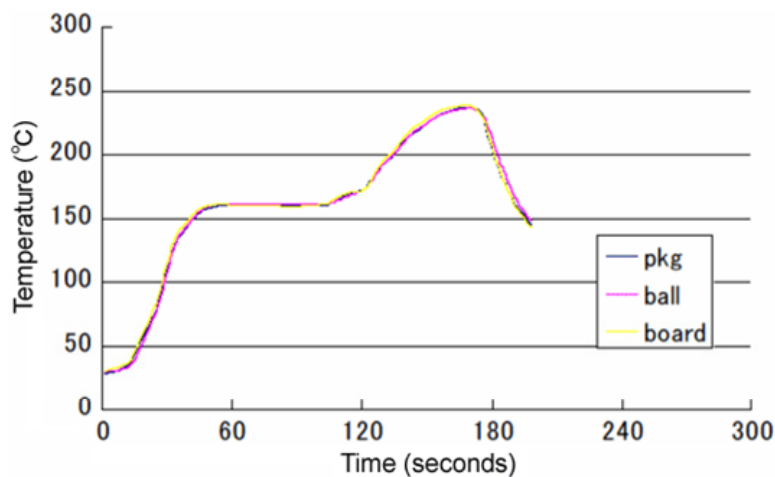
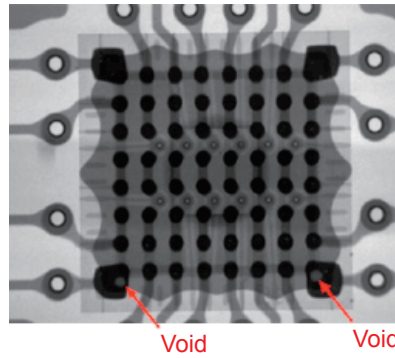


Figure 5.25 Reflow Soldering Temperature Profile

Reflow soldering is performed under the device stipulated heat-resistance temperature profile and within the recommended usage temperature conditions for the solder paste used.

(7) Verification After Soldering



Although voids can be seen, these do not affect mounting reliability.

Figure 5.26 X-Ray After Soldering

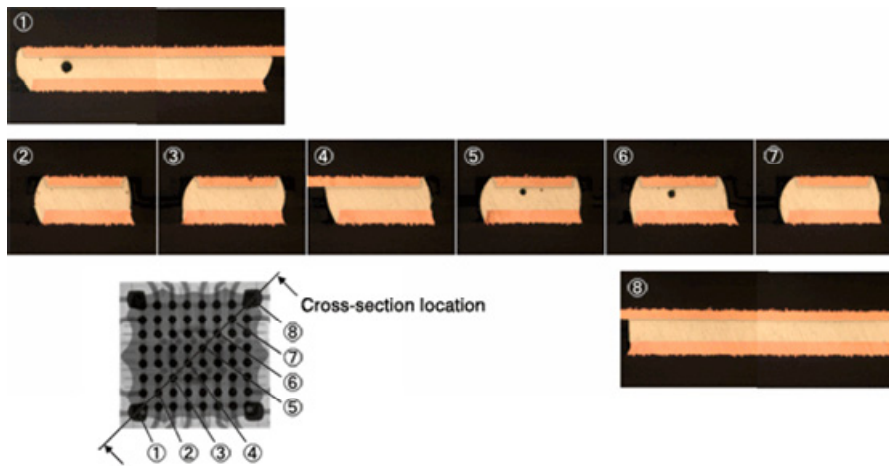


Figure 5.27 Cross Section After Soldering

5.2.2 LGA Problem Cases

(1) Problem Case 1: Solder Void

The LGA package has a tendency for voids to form more easily than with BGA packages. It is thought that since there are no solder balls, the printed solder directly contacts the package lands, and that as a result it is more difficult for air or gas to escape. As countermeasures, using a void reduction solder paste or displacing the package mounting position by about 30% of the pin pitch in the XY direction. Our results were that by using both methods, the mounting void area ratio was reduced from about 4.9% to about 0.6%,

Evaluation conditions

- Package: 7 × 7 mm, 48-pin FLGA; 0.8 mm pitch
- Copper pad diameter: 0.45 mm, SR aperture diameter: 0.55 mm
- Board pad structure and size: NSMD structure, copper pad diameter: 0.45 mm, SR aperture diameter: 0.55 mm
- Printing solder paste: Sn-3Ag-0.5Cu
- Stencil thickness: 150 μm

1. Before countermeasures

— Normal paste + no shift mounting

$$\text{Void area ratio (\%)} = \text{total void area} \div \text{total solder area} \times 100$$

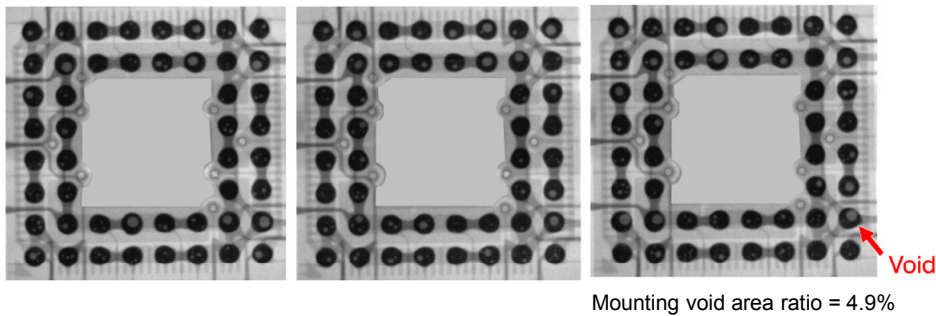


Figure 5.28 X-Ray Inspection (Before countermeasures)

2. After countermeasures

— Normal paste + shift mounting used

$$\text{Void area ratio (\%)} = \text{total void area} \div \text{total solder area} \times 100$$

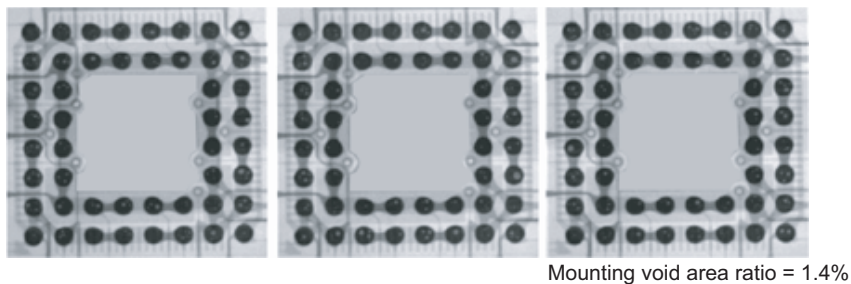


Figure 5.29 X-Ray Inspection (After countermeasure 1)

— Void reduction paste + shift mounting used

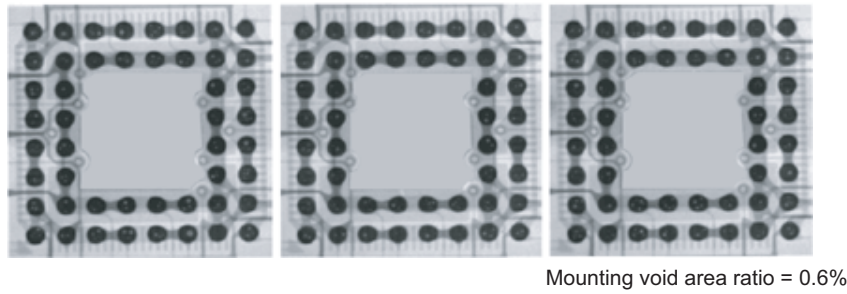


Figure 5.30 X-Ray Inspection (After countermeasure 2)

(2) Problem Case 2: Solder failure to join faults

In evaluating the mounting of an 11 × 11 mm, 192-pin FLGA package with a 0.65 mm pitch, solder failure to join faults occurred. We increased the stencil aperture diameter from 0.35 mm to 0.43 mm and increased the amount of solder printed.

The result was that solder failure to join faults no longer occurred and we acquired good solderability. The FLGA package does not have solder balls, and compared to the BGA package, the total amount of solder used is smaller. As a result, as the package size increases, it becomes more sensitive to package and printed wiring board warping. By increasing the amount of solder, it becomes easier for the solder to follow the warping.

1. Before countermeasures

- Package land structure/dimensions: NSMD structure, copper pad diameter = 0.35 mm, SR aperture diameter = 0.45 mm
- Stencil: aperture diameter = 0.35 mm, thickness = 100 μm

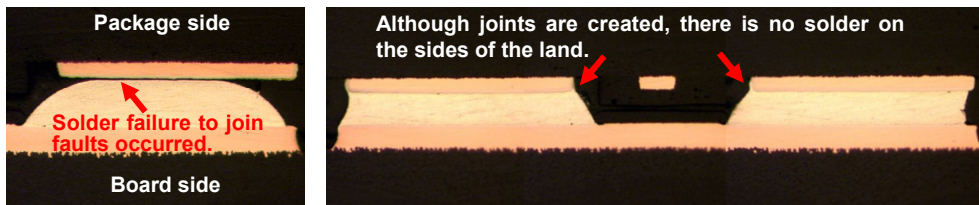


Figure 5.31 Cross Section After Soldering (Before countermeasures)

2. After countermeasures

- Stencil: aperture diameter = 0.43 mm, thickness = 100 μm

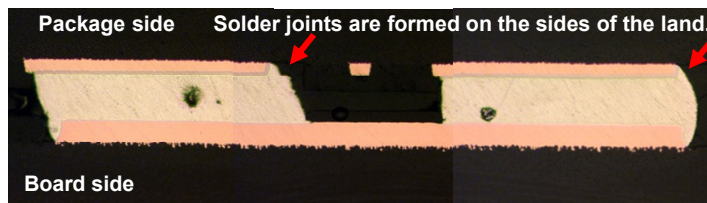


Figure 5.32 Cross Section After Soldering (After countermeasures)

5.3 Notes on Mounting Pad Design for HQFP and HLQFP Mounting

5.3.1 Mounting Pad Design Example for HLQFP Mounting

For HLQFP packages, we recommend solder resist, silkscreening, or other separate processing to assure an adequate amount of solder for the heat spreader at the corner of the package. Figure 5.33 presents a case where separate processing is used.

Separating these areas with solder resist or other means can prevent solder that reaches the package corner areas from flowing under the package. Solder influx under the package in excess of that required can lift the package and adversely affect connection with the lead pins.

We recommend verifying this for the solder materials and mounting conditions you are actually using.

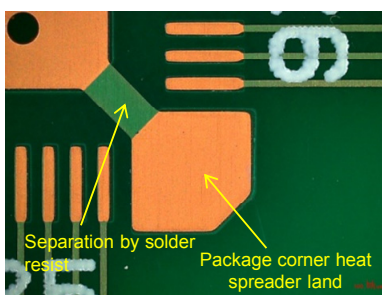


Figure 5.33 Photograph of Separation by Solder Resist

Figure 5.34 shows the experimental results of the effects of this separation.

1. In the evaluation of boards in which land separation was implemented, no solder influx under the package was found.
2. In the evaluation of boards in which land separation was not implemented, solder influx under the package was found.

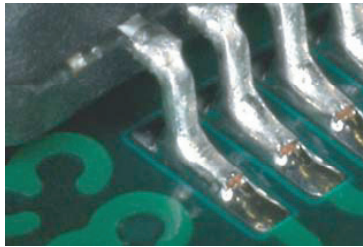
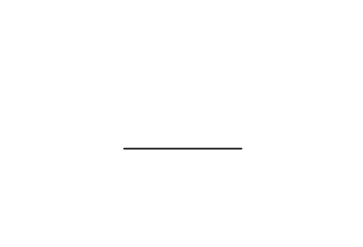

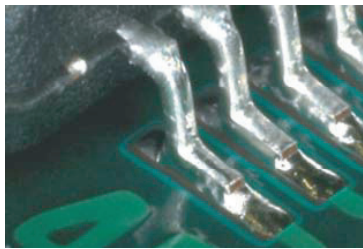
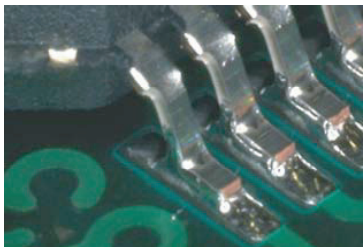
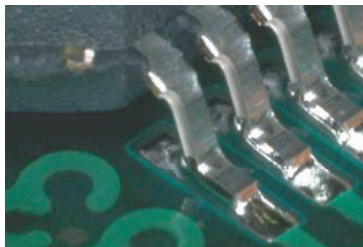
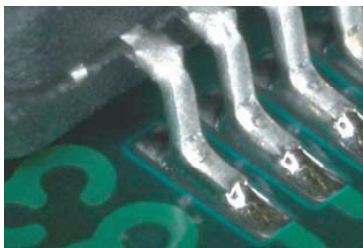



	Package observed from above	Package observed from an angle
Corner area lands separated		
Corner area lands not separated		

Figure 5.34 Photographs of the Mounted State

5.4 Lead-Free Solder Mounting Examples

5.4.1 External Appearance of Pins Plated with Lead-Free Solder (Lead-Type)

The external appearance when mounted of pins plated with lead-free solder may differ depending on the plating method used. It is therefore advisable to conduct mounting tests for confirmation. Figure 5.35 shows examples of the external appearance of the pins after mounting.

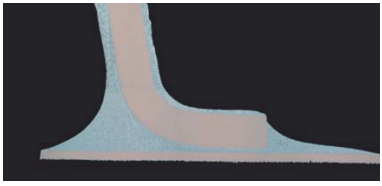
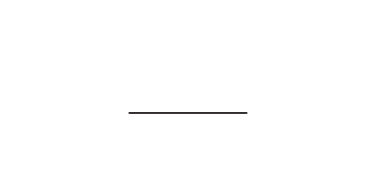
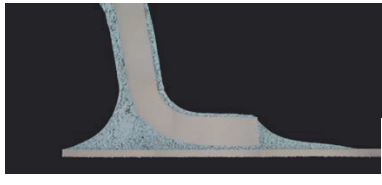







	Sn-Pb solder	Lead-free solder
Sn-Pb plating		
Sn plating		
Ni/Pd/Au plating*1		
Sn-Bi plating		
Sn-Cu plating		

Note: 1. Pre-applied plating

Figure 5.35 Examples Showing External Appearance when Mounted of Pins Plated with Lead-Free Solder

5.4.2 Cross Sectional Photographs after Mounting of Pins Plated with Lead-Free Solder (Lead-Type)

Figure 5.36 shows cross sectional photographs after mounting of pins plated with lead-free solder.

	Sn-Pb solder	Lead-free solder
Sn-Pb plating		
Sn plating		
Ni/Pd/Au plating*1		
Sn-Bi plating		
Sn-Cu plating		

Note: 1. Pre-applied plating

Figure 5.36 Examples of Cross Sectional Photographs after Mounting of Pins Plated with Lead-Free Solder

5.5 Mounting Example: 0.4 mm Pitch LQFP

This section presents notes on solder mounting 0.4 mm pitch LQFP packages.

5.5.1 Comparison of 0.5 and 0.4 Pitch LQFP Packages

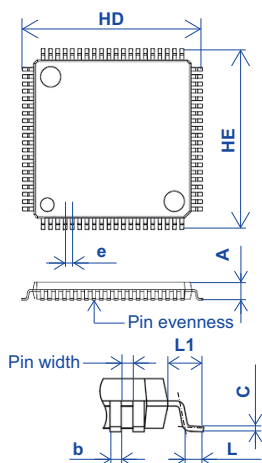


Figure 5.37 LQFP External View

Table 5.1 Comparison of 0.5 and 0.4 Pitch LQFP Packages

Dimensions		0.5 mm Pitch (Example: 1414-100p)	0.4 mm Pitch (Example: 1414-120)
External	HD	16.0	16.0
	HE	16.0	16.0
Pin pitch	e	0.5	0.4
Pin height	A	1.7	1.7
Pin width	b	0.20	0.18
Pin spacing		0.30	0.22
Pin thickness	c	0.145	0.145
Pin length	L	0.5	0.5
	L1	1.0	1.0
Pin evenness		0.10	0.08

Although there are no differences in the maximum external dimensions of 0.5 and 0.4 pitch packages with the same external forms, the pin width and the pin pitch become narrower. The pin strength has been confirmed according to the JEITA ED4701-400 standard. An example of the test results follows.

5.5.2 Pin Strength Test Example

- 1) Tensile test: 0.5 N × 10 seconds (cross sectional area: 0.02 to 0.03 mm²)
- 2) Bending test: ±15° (one cycle)

Table 5.2 Pin Strength Test Example

Pin pitch	Package Form	Pin Material	Pin Plating	Tensile Test	Bending Test
0.4 mm	LQFP128-1414-0.4	Cu	Sn	0/3	0/3

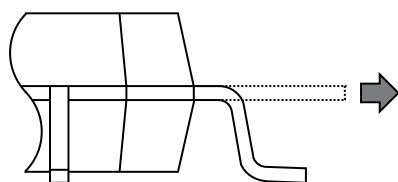


Figure 5.38 Pin Tensile Test Method

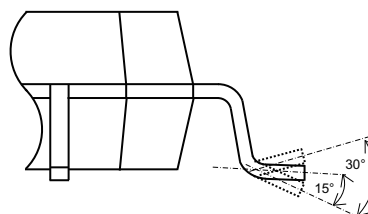


Figure 5.39 Pin Bending Test Method

Reference: JEITA ED4701-400

5.5.3 Mounting Pad Design

The mounting pad design for 0.4 mm pitch LQFP packages should follow section 2, Printed Wiring Board Design, in this document.

5.5.4 Solder Paste

See section 3, Mounting Processes, for the solder paste used for 0.4 mm pitch LQFP packages.

5.5.5 Mounting Example 1 — Solder Paste Squeezing When Mounting — (Reference Data)

The following presents a study of the concern that the printed solder paste could get squeezed out when devices are positioned on the printed wiring board and resulting in short circuits between pins.

(1) Evaluation Conditions

Table 5.3 Evaluation Specifications and Mounting Conditions

Solder Paste	Metal Mask Design (mm)	Mounting Speed	Mounting Load	Press-in Distance
Composition: Sn-3.0Ag-0.5Cu Granularity: Type 4	0.2 W × 1.3 L × 0.1 T	5.0 mm/s	2.2 N	0.5 mm

(2) Measurement Block

Figures 5.40, 5.41, and 5.42 show comparisons of measurements of solder paste widths before and after device mounting (placement).

No cases of solder paste being squeezed out and making contact with adjacent pattern items were found when mounting under ordinary mounting conditions.

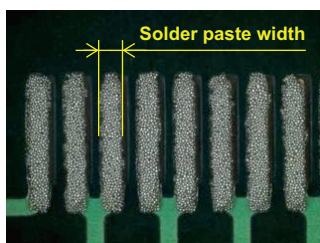


Figure 5.40 Solder Paste Before Mounting

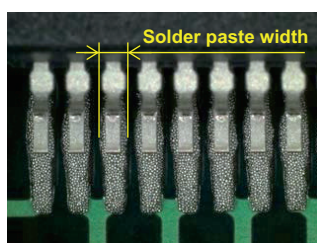


Figure 5.41 Solder Paste After Device Placement

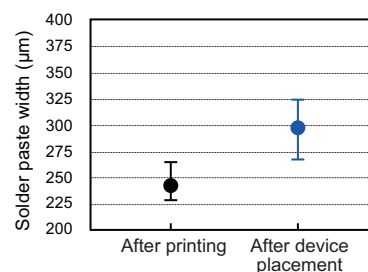


Figure 5.42 Solder Paste Squeezing After Device Placement

Furthermore, the number of short circuits observed after reflow soldering was 0 out of 50 (table 5.4).

While no short circuits were found under the ordinary mounting conditions in this mounting example, short circuits with adjacent pattern elements may occur due to ease of squeezing or ease of drooping in the solder actually used. Therefore a thorough study of this issue for the conditions actually used is required.

Table 5.4 Visual Inspection of Reflow Soldering

Solder Paste	Metal Mask Design (mm)	Reflow Temperature	Reflow Atmosphere	Short Circuits after Reflow
Composition: Sn-3.0Ag-0.5Cu Granularity: Type 4	0.2 W × 1.3 L × 0.1 T	245°C	Air	0 out of 50

5.5.6 Mounting Example 2 — Post Solder Mounting Testing — (Reference Data)

Table 5.5 shows the results of post solder mounting thermal cycle testing. No open circuits were found after 2000 cycles of a thermal cycle test from -40°C to 125°C.

Table 5.5 Post Solder Mounting Thermal Cycle Test Results

Package	Solder Paste	Mounting Board	Reflow Temperature (Atmosphere)	Evaluations	Thermal Cycles (-40°C to 125°C)		
					0 cycles	1000 cycles	2000 cycles
LQFP128-1414-0.4 (0.4 mm pitch)	SAC305	FR-4	240°C (Air)	25	0/25	0/25	0/25

Figures 5.43 and 5.44 show the strength measurement results from pin tensile strength testing. The tensile strength, when a pin is pulled upwards at 45°, falls according to the number of thermal cycles.

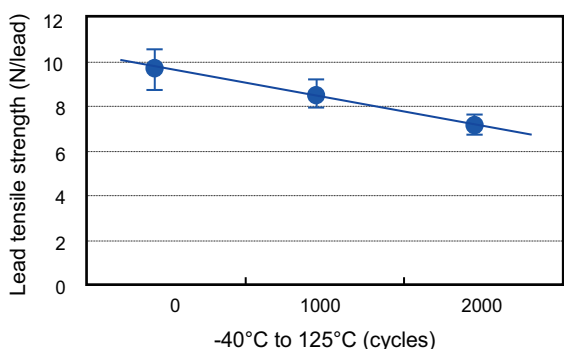


Figure 5.43 Pin Tensile Strength Test Results

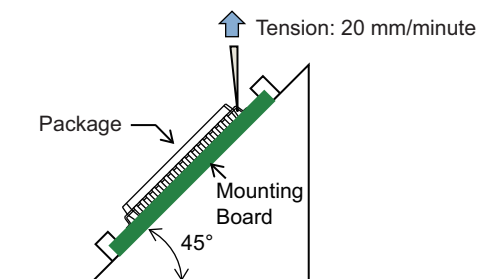


Figure 5.44 Tensile Test Geometry

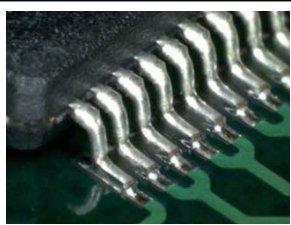
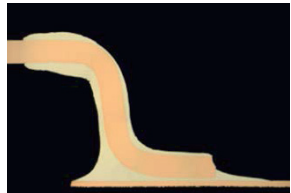
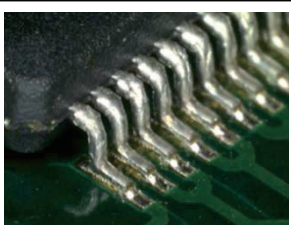
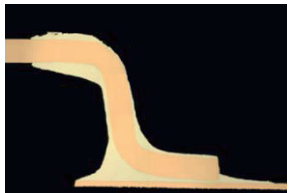
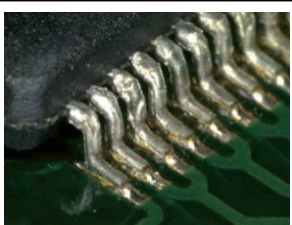
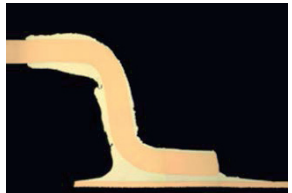
Package	Thermal Cycles (-40°C to 125°C)		
	0 cycles	1000 cycles	2000 cycles
LQFP128-1414-0.4	 	 	 

Figure 5.45 Post Solder Mounting Thermal Cycle Test Results (Appearance and Cross Section)

Figure 5.45 shows the appearance and the cross sections of device pins. While no cracks that could lead to open circuits were observed, we recommend repeating these tests for the boards and solder paste actually used in end products.

5.6 Mounting Example for Package with Header (Heat Spreader)

This section presents notes on solder mounting based on mounting examples for packages that have a header (heat spreader).

5.6.1 Mounting Example

When mounting a package with a header to a mounting board, there are cases when capillary balls (figure 5.46) or solder voids (figure 5.47) may form due to volatile gases that generated from the flux in the solder paste.

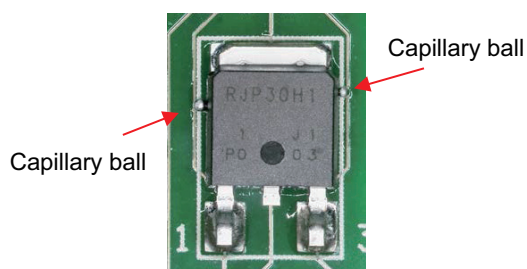


Figure 5.46 Capillary Ball Example

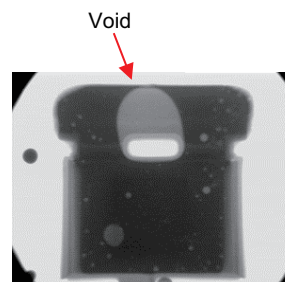


Figure 5.47 Solder Void Example

5.6.2 Improvement Example

To verify the effective influence of the mounting pad pattern and solder printing pattern, we provided slits to allow the volatile gasses from the flux in the solder paste to escape and verified the effect with a test. The results are presented below.

(1) Evaluation Conditions

Package: DPAK(S) (JEITA Code SC-63)

Solder Paste: Sn-3Ag-0.5Cu

Reflow Temperature: 260°C

(2) Test Method

We provided slits for the flux volatile gasses to escape as shown in figure 5.48 and investigated the generation status of capillary balls and voids.

	Condition A	Condition B	Condition C
Mounting pad pattern			
Solder printing pattern			

Figure 5.48 Flux Volatile Gas Escape Slits

- (1) Condition A has no slits
- (2) Condition B has slits only in the solder printing pattern
- (3) Condition C has slits in both the solder printing pattern and mounting pad pattern.

This section discusses solder paste volatile gas escape slits. As shown in figure 5.49, an opening is formed in the header area to improve the close contact between the resin and the frame. Since the opening is filled with sealing resin, and since solder wetting is prevented, we think that volatile gasses from the flux collect in this area, and we think that this could be the cause of capillary balls and voids. We hope for effects from creating an escape route for these volatile gasses and implemented soldering tests.

Note that figure 5.50 shows the relationship between the slits in the mounting pad pattern and the package header opening.

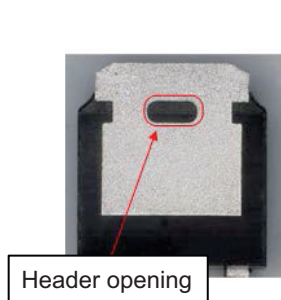


Figure 5.49 Package Back Side

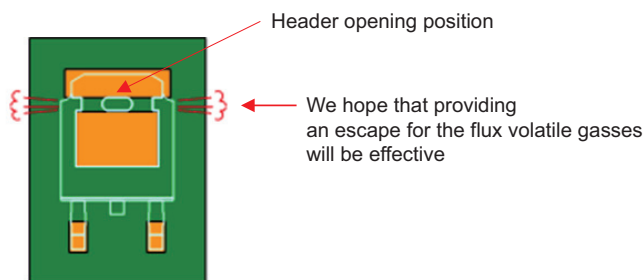


Figure 5.50 Slit Position

(3) Results

Table 5.6 shows the results of the board mounting test. Note that voids are evaluated by their size and that the standard for this evaluation is shown in figure 5.51.

- 1) Although capillary balls occurred in conditions A and B, they did not occur in condition C.
- 2) Although large voids occurred in conditions A and B, they did not occur in condition C.

We confirmed that the slits that provide escape routes for the volatile gasses from the flux in the solder paste are effective for reducing capillary balls and voids. Note that figure 5.52 shows observational photographs of the capillary balls and voids that occurred during these tests.

Table 5.6 Occurrence of Capillary Balls and Large Voids

	Condition A	Condition B	Condition C
Number of capillary balls	4/6	1/6	0/6
Number of voids	4/6	1/6	0/6

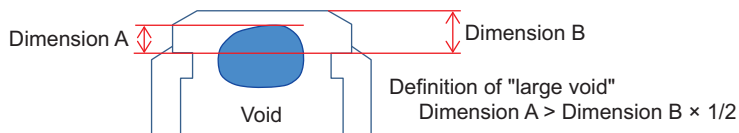


Figure 5.51 Large Void Definition

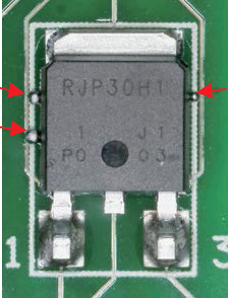
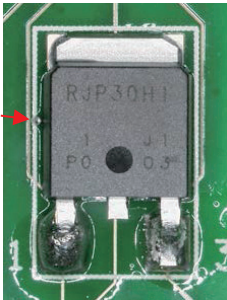
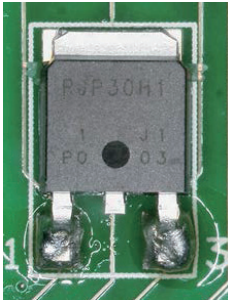

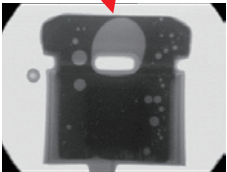
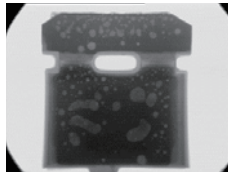
	Condition A	Condition B	Condition C
Capillary ball	 <p>Capillary ball example</p>	 <p>Capillary ball example</p>	 <p>Example with no capillary balls (since no capillary balls occurred)</p>
Void	 <p>Large void example</p>	 <p>Large void example</p>	 <p>Example with no large voids (since no large voids occurred)</p>

Figure 5.52 Examples of Capillary Balls and Large Voids Occurring in Each Condition

(4) Conclusions

We verified that providing slits in the mounting pattern and solder printing pattern is effective in reducing capillary balls and large voids. We recommend that users take these examples into consideration and look into adopting them for the solder and other materials used in creating end products.

5.7 Notes on HSON Mounting Pad Design

5.7.1 Printed Wiring Board Mounting Example for an 8-Pin HSON Package

While the 8-pin HSON package is a miniature, lightweight package with superb self-alignment properties, since the heat sink on the back of the package is asymmetrical in both the vertical and horizontal directions, care is required designing the mounting pads (heat dissipation sections) on the printed wiring board on which the package will be mounted. This section presents an example of mounting this package on a printed wiring board.

(1) Mounting Pad Design

The mounting pads are designed taking into consideration the pattern (A) used for forming the fillets used for the heat dissipation sections of the 8-pin SON package.

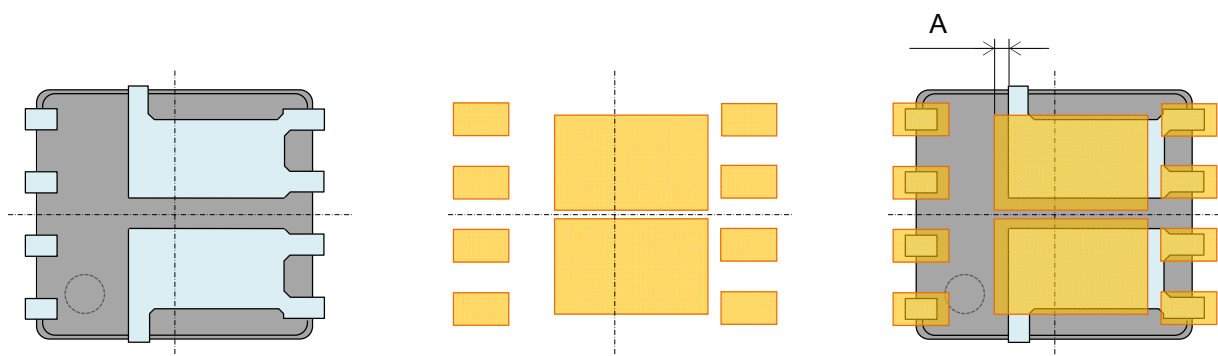


Figure 5.53 8-Pin HSON Package External View (Back Side)

Figure 5.54 8-Pin HSON Package Mounting Pad Drawing

Figure 5.55 8-Pin HSON Package Mounted Image

(2) Soldering Test Results (Self Alignment Characteristics)

- Solder mounting solder: Lead-free solder (Sn-Ag-Cu)
- Solder reflow: Convection reflow at 240°C
- Mounting evaluation board : Glass epoxy (FR-4)/mounting pad surface processing: Cu + OSP

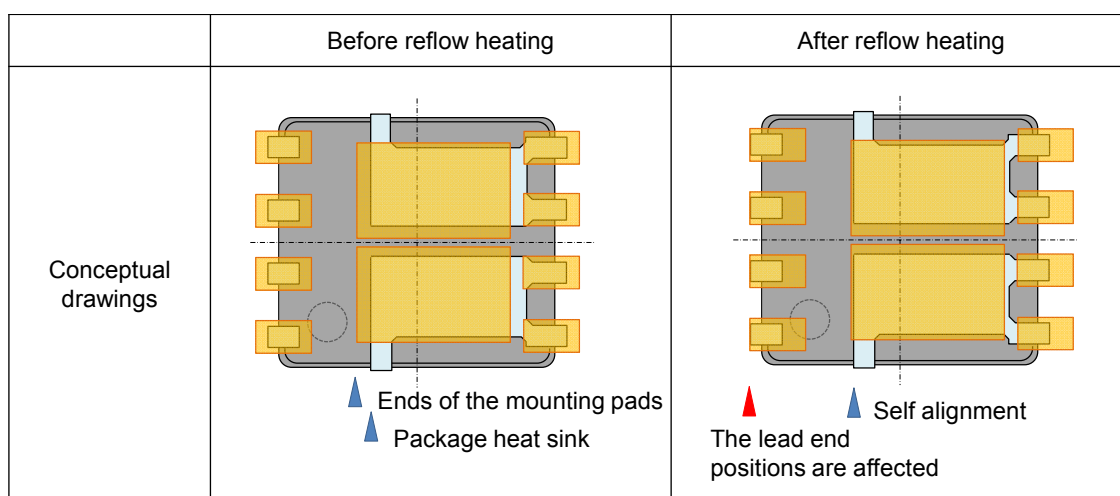


Figure 5.56 8-Pin HSON Package Self Alignment Characteristics During Reflow Heating

We confirmed that the package self aligned during soldering due to the surface tension of the solder resulting in mounting in a form in which the edge of the heat sink was aligned with the ends of the mounting pads on the printed wiring board.

(3) Consideration of the Results

When, during soldering, the influence of self alignment results in mounting with the end of the heat sink and the printed wiring board mounting pads aligned, it is possible that the soldered mounting pad sections at the lead tip side can be reduced. Also, there may be concern that capillary balls may be formed.

We think that, in consideration of the concern that self alignment may cause positional displacement, designing with dimensions that are the same as those of the heat sink can be effective.

Although in this example, we were unable to verify package displacement (alignment) in the direction where there are no leads, considering the possibility of motion, we think that designing with dimensions that are the same as those of the heat sink can be effective.

Note that this result only consists of a single example, and it is possible that your results may differ, depending on the materials actually used or the surface processing applied to the printed wiring board. Therefore we recommend that you test and evaluate thoroughly in advance of actual production.

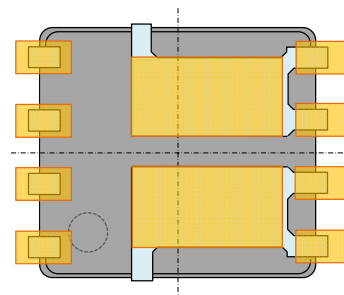


Figure 5.57 8-Pin HSON Package Mounting Pad Design Image

6. Solder Joint Reliability

6.1 Influence of Reflow Soldering Temperature

6.1.1 Ball-type SMD

The results of mounting a lead-free BGA package using Sn-3Ag-0.5Cu solder (melting point: 217°C to 220°C) and Sn-37Pb eutectic solder (melting point: 183°C) under various temperatures, visually checking the solder joint, and performing temperature cycle testing, are shown below.

If the BGA balls used for mounting are Sn-3Ag-0.5Cu and the solder paste is Sn-37Pb eutectic solder, the solder paste will not completely fuse beneath the solder ball melting point.

Moreover, during temperature cycle testing after mounting, if the reflow soldering temperature was low, the result will be that the temperature cycle life is short. Therefore, to obtain sufficient solder joint reliability, it is necessary to set the temperature to the solder ball or solder paste melting point (whichever is higher) + α , taking into consideration temperature variations during the mounting process.

(1) Solder Joint

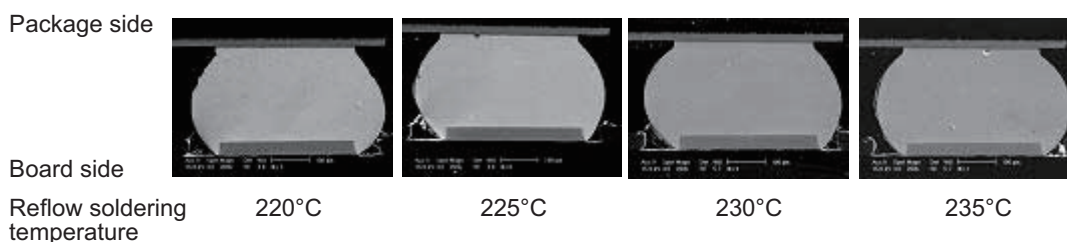


Figure 6.1 Sn-3Ag-0.5Cu Balls/Sn-3Ag-0.5Cu Paste

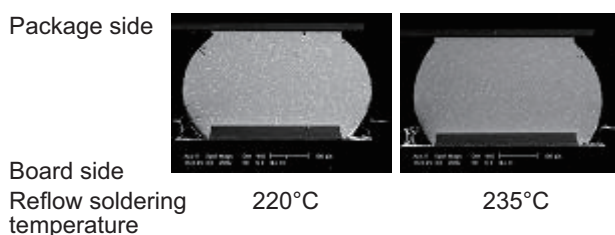
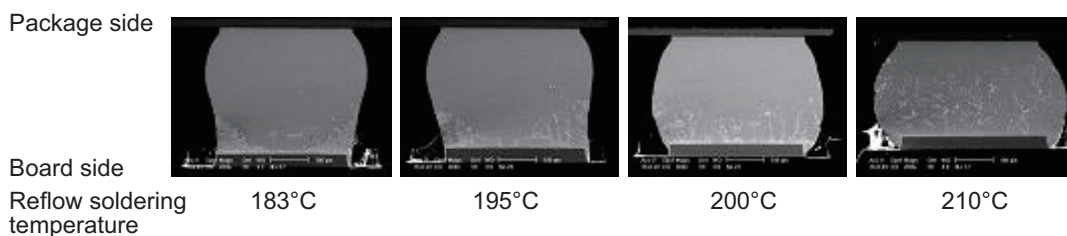


Figure 6.2 Sn-3Ag-0.5Cu Balls/Sn-37Pb Paste

(2) Temperature Cycle Characteristics

Balls	Paste	Soldering Temperature (°C)	Cycles															
			2000cy	2200	2400	2600	2800	3100	3300	3500	3700	3900	4100	4300	4500	4700	4900	5100
Sn-3Ag-0.5Cu	Sn-3Ag-0.5Cu	235	Package: 15 × 15 mm, 176-pin FBGA, 0.8 mm pitch Board: FR-4, 4 layers, t 0.8 mm Pad size: Cu φ0.4, SR φ0.55 mm															
Sn-3Ag-0.5Cu	Sn-3Ag-0.5Cu	230																
Sn-3Ag-0.5Cu	Sn-3Ag-0.5Cu	225																
Sn-3Ag-0.5Cu	Sn-3Ag-0.5Cu	220																
Sn-3Ag-0.5Cu	Sn-37Pb	235	No defects															
Sn-3Ag-0.5Cu	Sn-37Pb	220																
Sn-3Ag-0.5Cu	Sn-37Pb	215	Defects															
Sn-3Ag-0.5Cu	Sn-37Pb	210																
Sn-3Ag-0.5Cu	Sn-37Pb	205																
Sn-3Ag-0.5Cu	Sn-37Pb	200																
Sn-3Ag-0.5Cu	Sn-37Pb	195																
Sn-3Ag-0.5Cu	Sn-37Pb	190																
Sn-3Ag-0.5Cu	Sn-37Pb	183																

Figure 6.3 Thermal Cycle Test Results Using Sn-3Ag-0.5Cu Solder Ball and Sn-37Pb Paste

6.1.2 Lead-type SMD

The reliability results of mounting a lead type lead-free product using Sn-3Ag-0.5Cu solder under various temperatures and then evaluating the lead connection strength after temperature cycle testing are shown below.

Looking at these results, we can see a tendency toward lower strength as the number of temperature cycles is increased, regardless of whether the lead material is Cu or Fe-Ni (42 Alloy).

If the lead material is Cu, the lead connection strength tends to be somewhat higher at lower soldering temperatures, and if the lead material is Fe-Ni (42 Alloy), it ends to be somewhat higher at higher soldering temperatures.

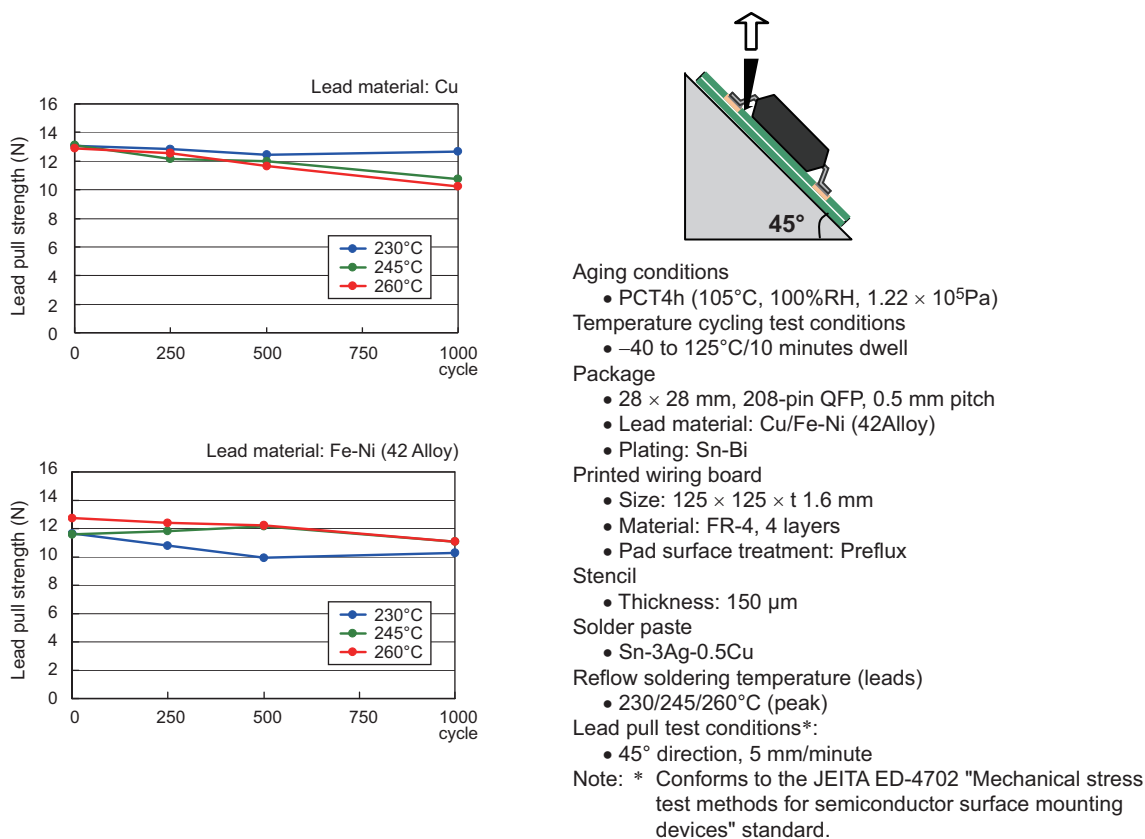


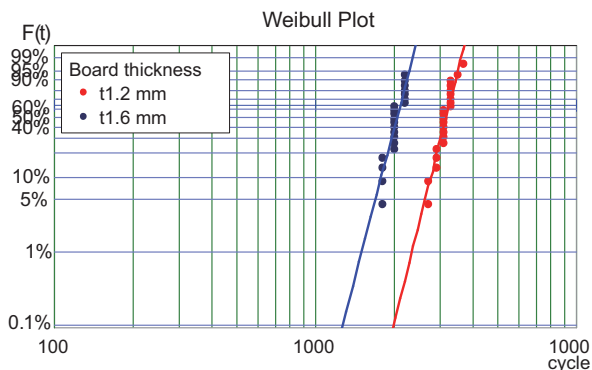
Figure 6.4 Lead Pull Strength

6.2 Influence of Printed Wiring Board Thickness

The reliability results of mounting the same package on printed wiring boards of various thicknesses and then performing temperature cycle testing are shown below.

In the condition range used this time, the temperature cycle life was longer for thinner printed wiring boards.

This is thought to be due to the fact that, in the case of a thick printed wiring board, it is more difficult for the board to keep up with the package's thermal expansion and contraction, which results in greater thermal stress on the solder joints.



- Test temperature
 - -40 to 125°C/10 minutes dwell
- Package
 - 16 × 16 mm, 224-pin FPBGA, 0.8 mm pitch, daisy chain
 - Ball composition: Sn-3Ag-0.5Cu
- Printed wiring board
 - Size: 124 × 130 × t 1.2 mm/t 1.6 mm
 - Material: FR-4, 4 layers
 - Pad size: Cu φ0.4, SR φ0.55 mm
 - Pad surface treatment: Preflux
- Stencil
 - Thickness: 150 μm
 - Aperture: φ0.4 mm
- Solder paste
 - Sn-3Ag-0.5Cu
- Reflow soldering temperature (package surface)
 - Max. 260°C
- Failure definition
 - 20% nominal resistance increase

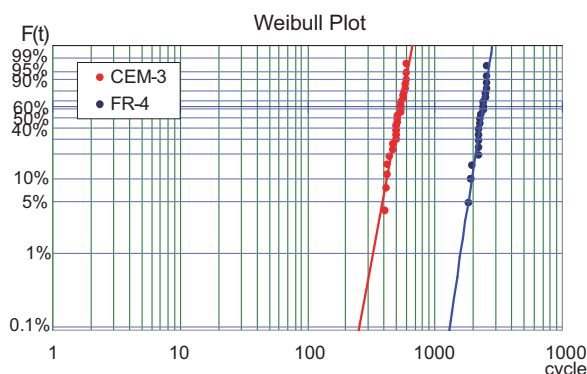
Figure 6.5 Weibull Plot (Influence of Printed Wiring Board Thickness)

6.3 Influence of Printed Wiring Board Materials (1)

This section presents the results of thermal cycle testing with the same packages mounted for printed wiring boards made from different materials.

These results show that within the following condition ranges, the FR-4 printed wiring board material has a longer thermal cycle life than CEM3.

We think that this is because it is difficult for the differences in thermal contraction of the printed wiring board to follow the thermal expansion of the packages and the stress on the solder joints is larger.



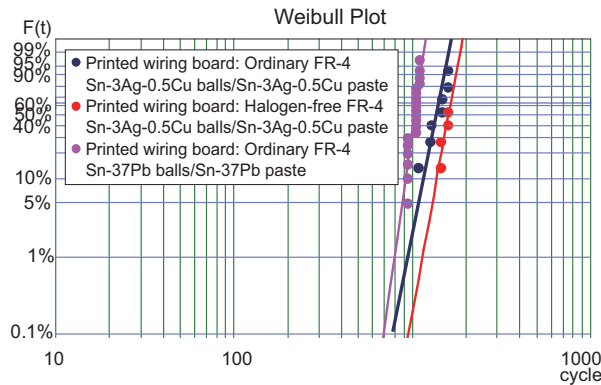
- Test temperature
 - -40 to 125°C/10 minutes dwell
- Package
 - 12 × 12 mm, 100-pin LQFP, 0.8 mm pitch
 - Sn-Bi plating
- Printed wiring board
 - Size: 124 × 130 × 1.6 mm
- Materials: 4-layer FR-4 and 2-layer CEM3
 - Pad size: 0.25 × 1.7 mm
 - Pad surface processing: preflux
 - Stencil
 - Thickness: 150 μm, Aperture: 0.25 × 1.7 mm
- Solder paste
 - Sn-3Ag-0.5Cu
- Reflow soldering temperature (package surface)
 - Peak: 250°C (Single reflow operation)
- Mounting form
 - Single-sided mounting
- Failure definition
 - 20% nominal resistance increase

Figure 6.6 Weibull Plot (Influence of Printed Wiring Board Materials 1)

6.4 Influence of Printed Wiring Board Materials (2)

This section presents the results of thermal cycle testing with FBGA packages mounted on boards made from ordinary FR-4 and halogen-free FR-4 materials.

These result show that within the following condition ranges, there were essentially no meaningful differences due to the difference in materials.



- Test temperature
 - 25 to 125°C/10 minutes dwell
- Package
 - 15 × 15 mm, 240-pin FBGA, 0.8 mm pitch
 - Ball composition: Sn-3Ag-0.5Cu
- Printed wiring board
 - Size: 65 × 58 × t 0.8 mm
 - Material: Ordinary FR-4/halogen-free FR-4
 - Pad size: φ0.40 mm
 - Pad surface processing: preflux
- Solder paste: Sn-3Ag-0.5Cu/Sn-37Pb
- Reflow soldering temperature (BGA ball)
 - Peak: 230°C/Sn-3Ag-0.5Cu paste
 - Peak: 220°C/Sn-37Pb paste
- Mounting form
 - Double-sided mounting
- Failure definition
 - 20% nominal resistance increase

Figure 6.7 Weibull Plot (Influence of Printed Wiring Board Materials 2)

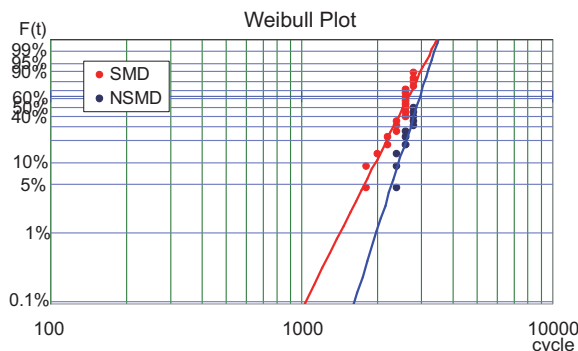
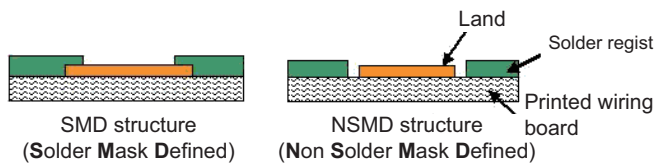
6.5 Influence of Printed Wiring Board Pad Structure

The results of mounting the same package on printed wiring boards with an NSMD and SMD land structure and then performing temperature cycle testing are shown below.

For the following conditions range, the NSMD structure has a longer temperature cycle life than the SMD structure.

This is believed to be due to the fact that, when the NSMD structure is used, the solder connection strength is greater because the pad sides are also soldered.

On the other hand, use of the NSMD structure has the demerit that the neck part of the pad lead-out wiring can easily break due to mechanical stress. Therefore, the land structure must be selected according to the intended application.



- Test temperature
 - 40 to 125°C/10 minutes dwell
- Package
 - 13 × 13 mm, 225-pin FBGA, 0.65 mm pitch, daisy chain
 - Ball composition: Sn-37Pb
- Printed wiring board
 - Size: 124 × 130 × t 0.8 mm
 - Material: FR-4, 4 layers
 - Pad size
- NSMD: Cu φ0.35, SR φ0.45 mm
- SMD: Cu φ0.45, SR φ0.35 mm
- Pad surface treatment: Preflux
- Stencil
 - Thickness: 150 μm, Aperture: φ0.35 mm
- Solder paste
 - Sn-37Pb
- Reflow soldering temperature (package surface)
 - Max. 235°C
- Failure definition
 - 20% nominal resistance increase

Figure 6.8 Weibull Plot (Influence of Printed Wiring Board Pad Structure)

6.6 Single-Sided and Double-Sided Mounting

This section presents the results of thermal cycle testing of double-sided mounting with four types of position shifting compared with single-sided mounting. These results show that type II, with 100% overlap in double-sided mounting, has significantly worse performance in thermal cycling compared to type I single-sided mounting. Furthermore, we found that type V double-sided mounting with packages displaced by the size of the package width provides essentially the same performance in thermal cycling as single-sided mounting.

When designing printed wiring boards, find ways to assure that for any given package, there is no corresponding package in the same position on the other side of the board.

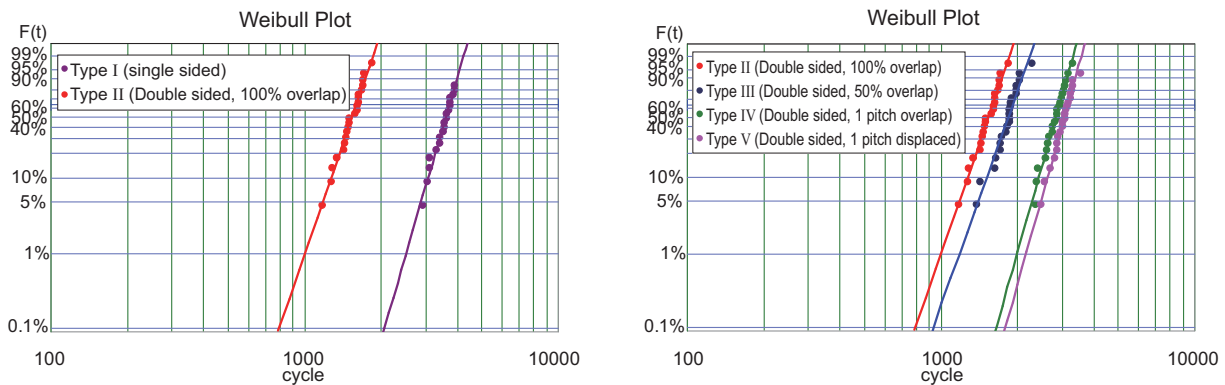
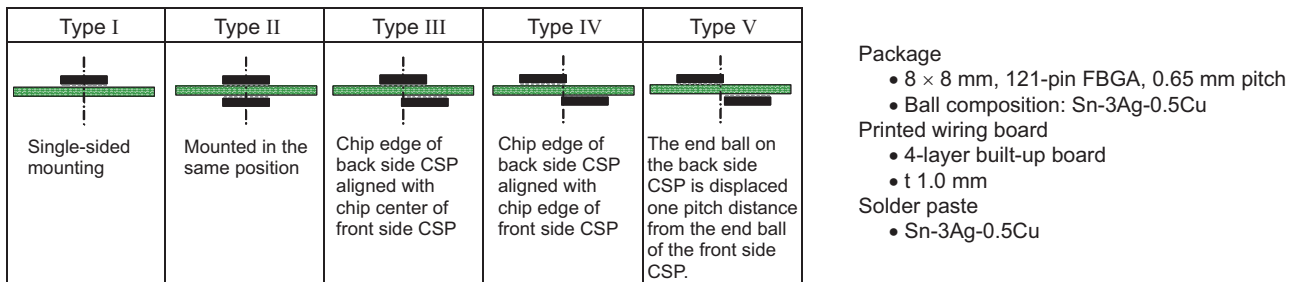


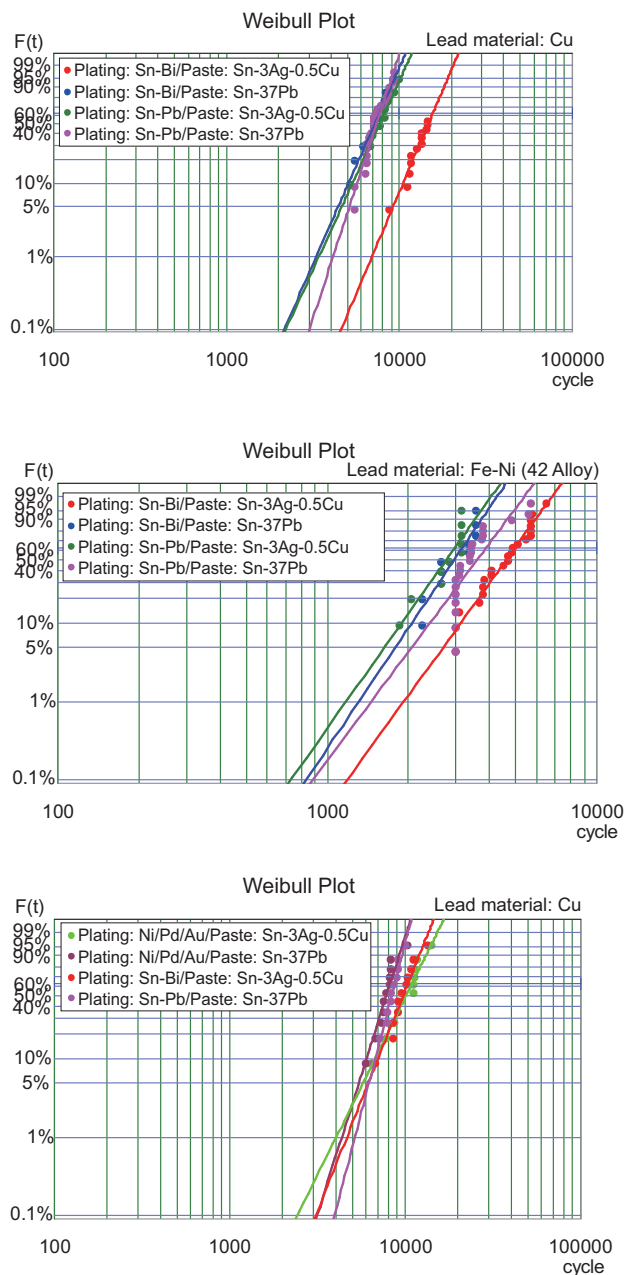
Figure 6.9 Weibull Plots (Single-Sided and Double-Sided Mounting)

6.7 Combinations of Package Lead Pin Plating and Solder Materials

For lead type SMD, the reliability (temp cycle) results of mounting conventional Sn-Pb plated products and lead-free Sn-Bi plated products and Ni/Pd/Au plated products with conventional Sn-37Pb eutectic solder and lead-free Sn-3Ag-0.5Cu solder, are shown below.

The combination of the lead-free product with the lead-free solder yielded temperature cycle characteristics superior to those of the conventional combination, and the combination of the conventional product with lead-free solder, and lead-free product with conventional solder, yielded inferior results.

Since the combination of Sn-37Pb solder with lead-free solder leads to reduced thermal cycle performance in some cases, thorough evaluation in advance is required if mounting materials with differing compositions are selected.



Test temperature

- -40 to 125°C/10 minutes dwell

Package

- 28 × 28 mm, 208-pin QFP, 0.5 mm pitch, daisy chain
- Lead material: Cu/ Fe-Ni (42Alloy)
- Plating: Sn-Bi/Sn-Pb/Ni/Pd/Au

Printed wiring board

- Size: 125 × 125 × t 1.6 mm
- Material: FR-4, 4 layers
- Pad surface treatment: Preflux

Stencil

- Thickness: 150 μm

Solder paste

- Sn-3Ag-0.5Cu/Sn-37Pb

Reflow soldering temperature (leads)

- Sn-3Ag-0.5Cu paste: Max. 245°C
- Sn-37Pb paste: Max. 220°C

Failure definition

- 20% nominal resistance increase

Figure 6.10 Weibull Plots (Combinations of Plating Compositions and Solder Materials)

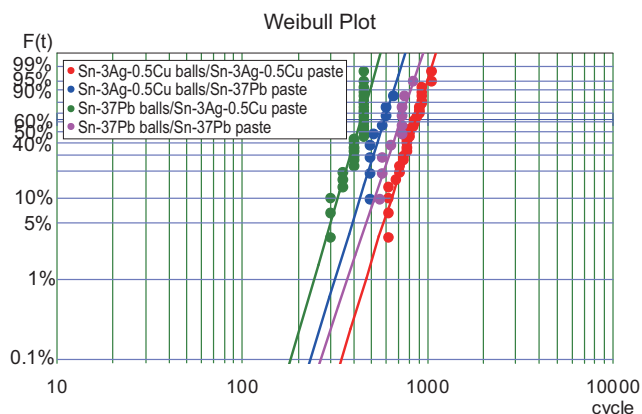
6.8 Combinations of Package Ball Pin and Solder Materials

This section presents the results, for ball-type SMD packages, of thermal cycle testing and mechanical shock testing of combined mounting of earlier Sn-37Pb eutectic solder products and lead-free Sn-3Ag-0.5Cu ball products with both Sn-37Pb solder paste and Sn-3Ag-0.5Cu solder paste.

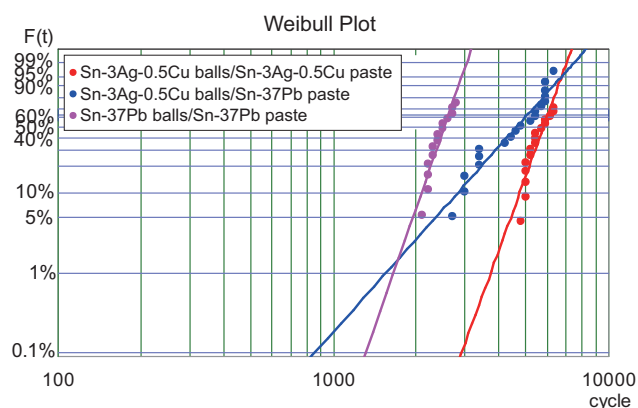
These results show that combinations of differing materials are inferior to combinations of earlier materials in both thermal cycle and mechanical shock performance.

Since combinations of Sn-37Pb solder materials with Sn-3Ag-0.5Cu solder materials result in degraded thermal cycle and mechanical shock performance, thorough evaluation in advance is required if mounting materials with differing compositions are selected.

(1) Resistance to Thermal Cycling



- Test temperature
 - -25 to 125°C/10 minutes dwell
- Package
 - 13 × 13 mm, 175-pin FBGA, 0.8 mm pitch, daisy chain
 - Ball composition: Sn-3Ag-0.5Cu/Sn-37Pb
- Printed wiring board
 - Size: 65 × 65 × t 0.8 mm
 - Material: FR-4, 4 layers
 - Pad: NSMD: Cu φ0.32 mm, SR φ0.52 mm
 - Pad surface treatment: Preflux
- Stencil
 - Thickness: 130 μm
 - Aperture: φ0.32 mm
- Solder paste
 - Sn-3Ag-0.5Cu/Sn-37Pb
- Reflow soldering temperature (lead)
 - Sn-3Ag-0.5Cu paste: Max. 230°C
 - Sn-37Pb paste: Max. 220°C
- Failure definition
 - 20% nominal resistance increase



- Test temperature
 - -40 to 125°C/10 minutes dwell
- Package
 - 15 × 15 mm, 176-pin FBGA, 0.8 mm pitch, daisy chain
 - Ball composition: Sn-3Ag-0.5Cu/Sn-37Pb
- Solder paste
 - Sn-3Ag-0.5Cu/Sn-37Pb
- Reflow soldering temperature (lead)
 - Sn-3Ag-0.5Cu paste: Max. 250°C
 - Sn-37Pb paste: Max. 235°C
- Failure definition
 - 20% nominal resistance increase

Figure 6.11 Weibull Plots (Combinations of Ball Composition and Solder Materials)

(2) Resistance to Mechanical Shock

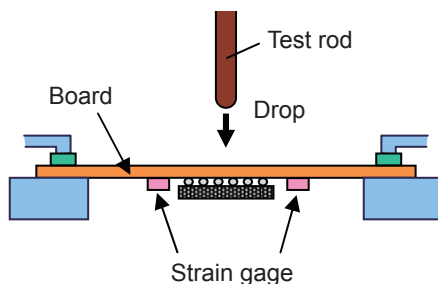


Figure 6.12 Resistance to Mechanical Shock Test Method

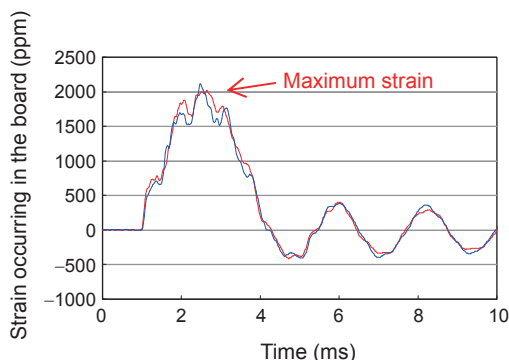


Figure 6.13 Board Strain Test Method

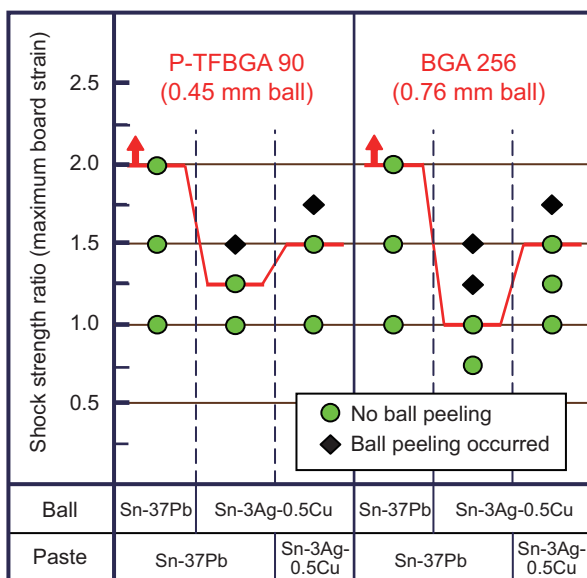


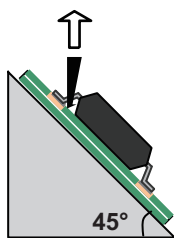
Figure 6.14 Shock Strength Test Method

6.9 Mechanical Strength

6.9.1 QFP Lead Connection Strength

This section presents the results of thermal cycle testing for various combinations of plating materials, frame materials, and solder materials.

Although we compared lead strengths taking the earlier Sn-Pb plating/Sn-37Pb paste mounting as the reference, these results show that the solder materials have almost no influence on the strength.



Temperature cycling test conditions

- -40 to 125°C/15 minutes dwell

Package

- 14 × 14 mm, 100-pin QFP, 0.5 mm pitch
- Lead materials: Cu/Fe-Ni (42 Alloy)
- Lead plating: Sn-Cu, Sn-Bi, Sn, Ni/Pd/Au

Printed wiring board

- Size: 60 × 90 × t 1.2 mm
- Material: FR-4, 4 layers
- Pad surface treatment:

Stencil

- Thickness: 130 μm

Solder paste

- Sn-3Ag-0.5Cu/Sn-37Pb

Reflow soldering temperature (lead)

- 230°C (for combinations involving only earlier materials, 220°C)

Strength conditions*

- 45° direction, 20 mm/minute

Note: * Conforms to the JEITA ED-4702 "Mechanical stress test methods for semiconductor surface mounting devices" s standard.

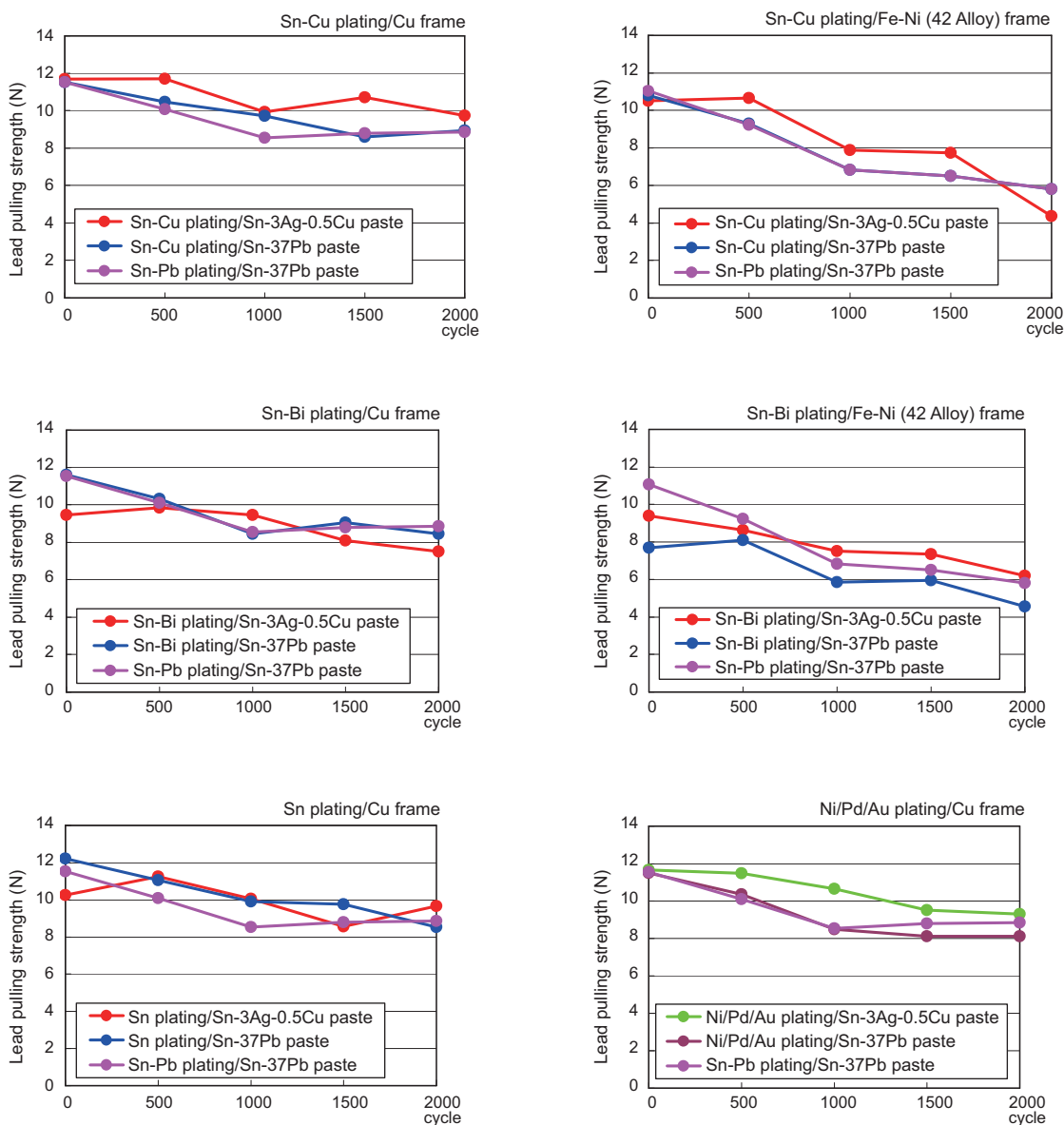


Figure 6.15 Lead Pull Strength

6.9.2 BGA Ball Attachment Strength after High-Temperature Storage

This section presents the results of investigating changes in the ball attachment strength after high-temperature storage for earlier Sn-37Pb eutectic solder ball products and lead-free Sn-3Ag-0.5Cu ball products.

These results show that while both types of solder ball show similar reductions at up to 200 hours at 150°C, there were no changes in strength after that.

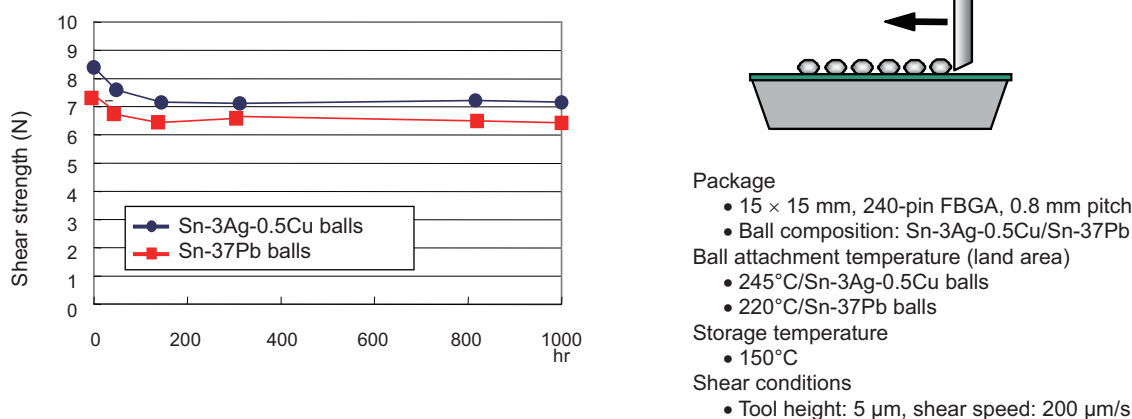


Figure 6.16 Ball Shear Strength

6.9.3 Measures to Improve Resistance to Mechanical Shock

We recommend finding ways, such as using adhesives, to increase mechanical strength in equipment that may be subject to excessive mechanical shocks, such as manufacturing stresses during board separation, accidental dropping, or for portable equipment. When selecting an adhesive, refer to the evaluation cases shown below and perform a thorough evaluation in advance.

Improvement in Mechanical Strength and the Effect and Influence on Thermal Cycle Performance of an Underfill Material - Evaluation case for a 0.5 mm pitch BGA package

It is recognized that mechanical strength can be improved by applying an underfill adhesive. In particular, this is highly effective for improving resistance to fast deformation speeds due to dropping. In contrast, disconnection faults that depend on the physical properties of the underfill adhesive occur in thermal cycle testing, and the results show a shortened life when T_g (the glass transition temperature) is lower than the test temperature. The underfill adhesive must be selected based on thorough testing in advance for usage temperatures taking into account heat generation by the end product itself during operation.

Note that since the physical property values for the adhesives presented here are taken from the manufacturer's catalogs, we recommend referring to the technical documentation on the adhesives and consulting with the manufacturer on the intended use.

Table 6.1 Mechanical Strength Test Results

Evaluation Item	Assumed Stress	Test Conditions	Results		
			No underfill		Underfill (material A) used
			Mounting complete	Two additional reflow operations	Two additional reflow operations
Mechanical drop test	Normal usage	100 g load dropped vertically	NG after 1 to 5 times	NG after 1 to 5 times	OK after 20 times
		100 g load, height of 1.5 m, above concrete 1 cycle = vertical → horizontal → flat	NG after 1 to 5 times	NG after 1 to 5 times	OK after 20 cyc
Shock bend test	Customer mounting process	Span = 90 mm	OK after 2500 ppm NG after 3000 ppm	OK after 2000 ppm NG after 2500 ppm	OK after 5000 ppm
Repeated bending test	Normal usage	Span = 90 mm 2 times/second	OK after 10k times	OK after 7k times NG after 10k times	OK after 20k times
Bending limit test	↑	Span = 90 mm	5 mm and 3 seconds OK after 5 times	5 mm and 3 seconds OK after 5 times	5 mm and 3 seconds OK after 5 times

Table 6.2 Thermal Cycle Test Results (number of disconnects/number of evaluations)

Underfill material				-55°C/10 min. to 125°C/10 min.						-40°C/10 min. to 85°C/10 min.				
Product	$\alpha 1$ (/ppm)	$\alpha 2$ (/ppm)	T _g (°C)	300	500	800	1 k	1.5 k	2 k	1 k	2 k	3 k	3.5 k	4 k
None	—	—	—	0/5	0/5	1/5	2/5	5/5	—	0/10	0/10	0/10	0/10	0/10
Material A	30	100	140	0/5	0/5	0/5	0/5	0/5	0/5	0/10	0/10	0/10	0/10	0/10
Material B	34	102	115	0/5	0/5	0/5	2/5	3/5	5/5	0/7	0/7	0/7	0/7	0/7
Material C	60	180	95	3/5	5/5	—	—	—	—	0/7	0/7	0/7	1/7	1/7

6.10 Migration

Along with the shift to lead-free products, the number of lead plating, solder, and other materials is increasing, and ion migration risks occurring in solder joints. The results of ion migration evaluation of various combinations of lead material, solder plating, and solder paste are shown below.

It was confirmed that no ion migration occurs with any of the combinations.

Table 6.3 Ion Migration Test Results

Level	Lead Material	Lead Plating	Solder Paste	n	Test Time (h)					
					0	300	500	700	1000	1200
1	Cu	Sn-1Bi	Sn-3Ag-0.5Cu	5	0/5	0/5	0/5	0/5	0/5	0/5
2		Sn-3Bi	Sn-3Ag-0.5Cu	5	0/5	0/5	0/5	0/5	0/5	0/5
3		Sn-5Bi	Sn-3Ag-0.5Cu	5	0/5	0/5	0/5	0/5	0/5	0/5
4		Sn-Pb	Sn-37Pb	5	0/5	0/5	0/5	0/5	0/5	0/5
5	Fe-Ni (42 Alloy)	Sn-1Bi	Sn-3Ag-0.5Cu	5	0/5	0/5	0/5	0/5	0/5	0/5
6		Sn-3Bi	Sn-3Ag-0.5Cu	5	0/5	0/5	0/5	0/5	0/5	0/5
7		Sn-5Bi	Sn-3Ag-0.5Cu	5	0/5	0/5	0/5	0/5	0/5	0/5
8		Sn-Pb	Sn-37Pb	5	0/5	0/5	0/5	0/5	0/5	0/5

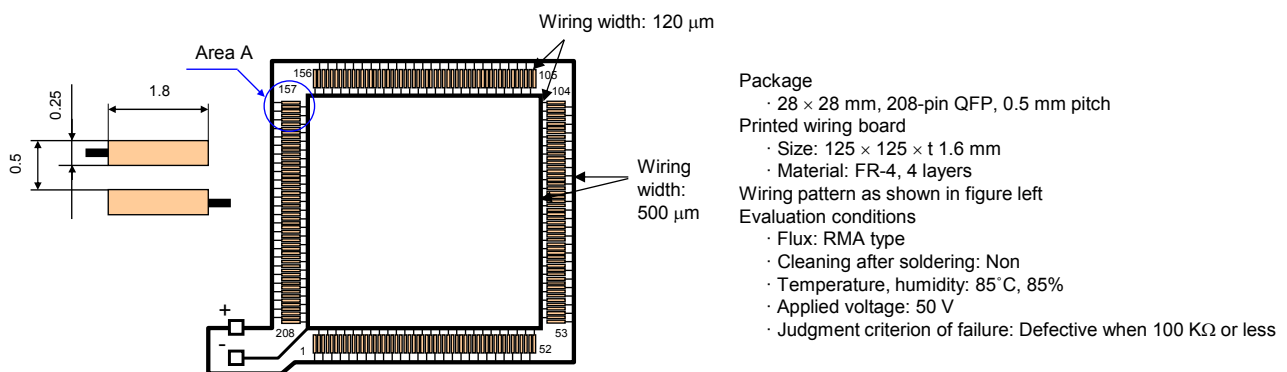


Figure 6.17 Ion Migration Evaluation Board

7. Appendix

7.1 Characteristics of Constituent Materials

7.1.1 Thermal Expansion Coefficients of Constituent Materials

The thermal expansion coefficients (linear expansion coefficients) for the materials used to configure packages are shown below.

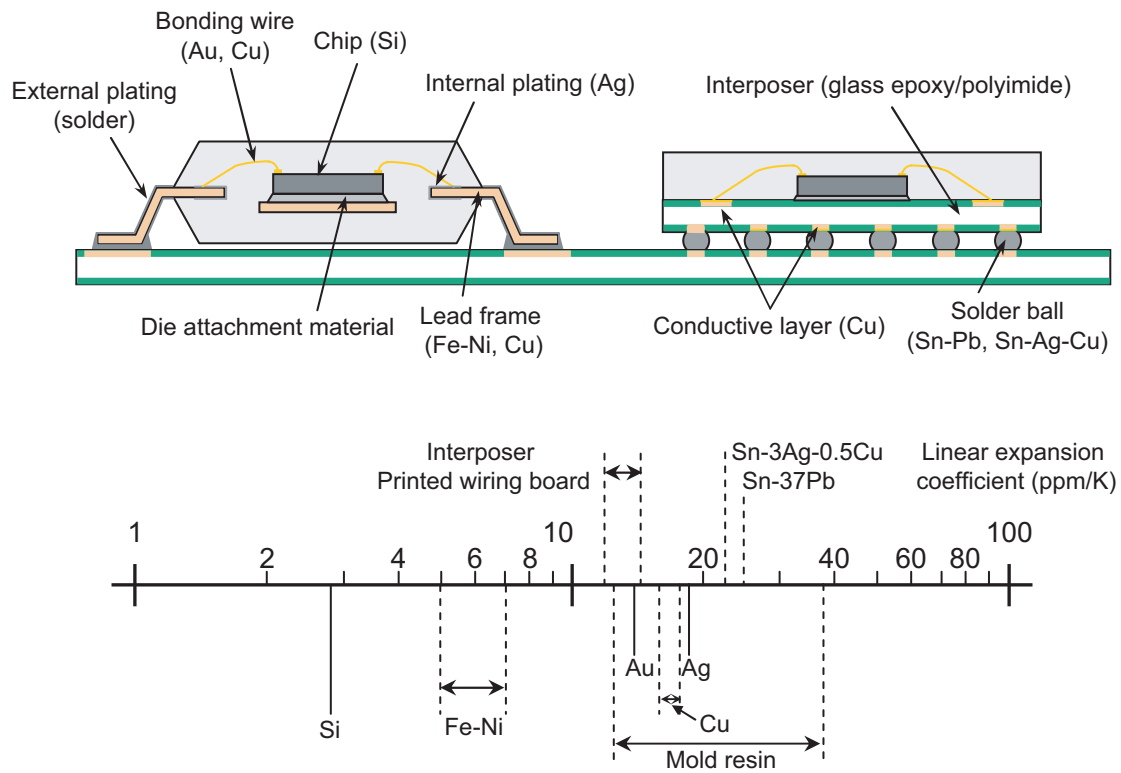


Figure 7.1 Thermal Expansion Coefficients of Constituent Materials

Semiconductor Package Mount Manual

Publication Date: Rev.1.00 November 24, 2010
Rev.8.00 December 25, 2018

Published by: Renesas Electronics Corporation

**SALES OFFICES****Renesas Electronics Corporation**<http://www.renesas.com>Refer to "<http://www.renesas.com/>" for the latest and detailed information.**Renesas Electronics America Inc.**1001 Murphy Ranch Road, Milpitas, CA 95035, U.S.A.
Tel: +1-408-432-8888, Fax: +1-408-434-5351**Renesas Electronics Canada Limited**9251 Yonge Street, Suite 8309 Richmond Hill, Ontario Canada L4C 9T3
Tel: +1-905-237-2004**Renesas Electronics Europe Limited**Dukes Meadow, Millboard Road, Bourne End, Buckinghamshire, SL8 5FH, U.K
Tel: +44-1628-651-700, Fax: +44-1628-651-804**Renesas Electronics Europe GmbH**Arcadiastrasse 10, 40472 Düsseldorf, Germany
Tel: +49-211-6503-0, Fax: +49-211-6503-1327**Renesas Electronics (China) Co., Ltd.**Room 1709 Quantum Plaza, No.27 ZhichunLu, Haidian District, Beijing, 100191 P. R. China
Tel: +86-10-8235-1155, Fax: +86-10-8235-7679**Renesas Electronics (Shanghai) Co., Ltd.**Unit 301, Tower A, Central Towers, 555 Langao Road, Putuo District, Shanghai, 200333 P. R. China
Tel: +86-21-2226-0888, Fax: +86-21-2226-0999**Renesas Electronics Hong Kong Limited**Unit 1601-1611, 16/F., Tower 2, Grand Century Place, 193 Prince Edward Road West, Mongkok, Kowloon, Hong Kong
Tel: +852-2265-6688, Fax: +852 2886-9022**Renesas Electronics Taiwan Co., Ltd.**13F, No. 363, Fu Shing North Road, Taipei 10543, Taiwan
Tel: +886-2-8175-9600, Fax: +886 2-8175-9670**Renesas Electronics Singapore Pte. Ltd.**80 Bendemeer Road, Unit #06-02 Hyflux Innovation Centre, Singapore 339949
Tel: +65-6213-0200, Fax: +65-6213-0300**Renesas Electronics Malaysia Sdn.Bhd.**Unit 1207, Block B, Menara Amcorp, Amcorp Trade Centre, No. 18, Jln Persiaran Barat, 46050 Petaling Jaya, Selangor Darul Ehsan, Malaysia
Tel: +60-3-7955-9390, Fax: +60-3-7955-9510**Renesas Electronics India Pvt. Ltd.**No.777C, 100 Feet Road, HAL 2nd Stage, Indiranagar, Bangalore 560 038, India
Tel: +91-80-67208700, Fax: +91-80-67208777**Renesas Electronics Korea Co., Ltd.**17F, KAMCO Yangjae Tower, 262, Gangnam-daero, Gangnam-gu, Seoul, 06265 Korea
Tel: +82-2-558-3737, Fax: +82-2-558-5338

Semiconductor Package Mount Manual



Renesas Electronics Corporation

R50ZZ0003EJ0800