

Packaging Information

PCB Design and Assembly Recommendations for Intersil HDA Module Technology

TB498
Rev 2.00
December 13, 2016

Introduction

Intersil's module product family offers a unique packaging concept, the High Density Array (HDA) package. HDA encompasses lead pitches of 1.0mm and above. This package offers a variety of benefits including reduced lead inductance and both perimeter I/O pins (to ease PCB trace routing) and in-board I/O pins (for complex pinouts). Also, the exposed Au plated copper ePad technology offers good thermal and electrical performance. These features make the HDA packaged POL module an ideal choice for many new applications where thermal and electrical performance are important.

This tech brief provides general guidelines for use in developing land pattern layouts and solder mounting processes. It should be emphasized that these guidelines are general in nature and should only be considered a starting point in this effort. The user must apply their actual experiences and development efforts to optimize designs and processes for their manufacturing practices and the needs of varying end-use applications.

Package Construction

High Density Array (HDA) Module Packing Highlights

- HDA based on copper (Cu) lead frame technology
 - Cu lead frame provides one routing layer
 - Jumper wires and traces under components provide crossovers
- HDA provides superior thermal performance
 - Power dissipating components are mounted directly to Cu lead frame for improved thermal performance.
- HDA is flexible
 - Intersil offers a comprehensive family of HDA modules with thicknesses of 2.5mm, 3.7mm, and 7.5mm maximum (with 5.3mm maximum arriving soon)
 - The HDA lead frame can be quickly modified to produce new products
- HDA provides high SMT yields
 - NiPdAu lead finish provides excellent solderability
 - I/O terminals and ePads form a seating plane below solder mask for easier SMT solder mounting

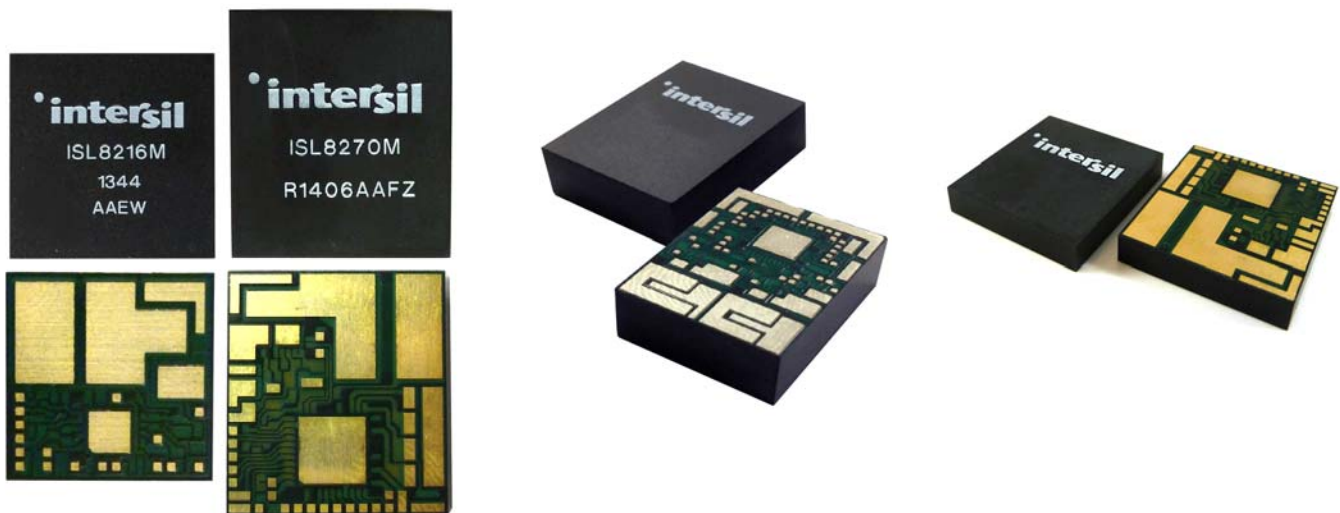

FIGURE 1. TYPICAL HDA MODULE PHOTOS

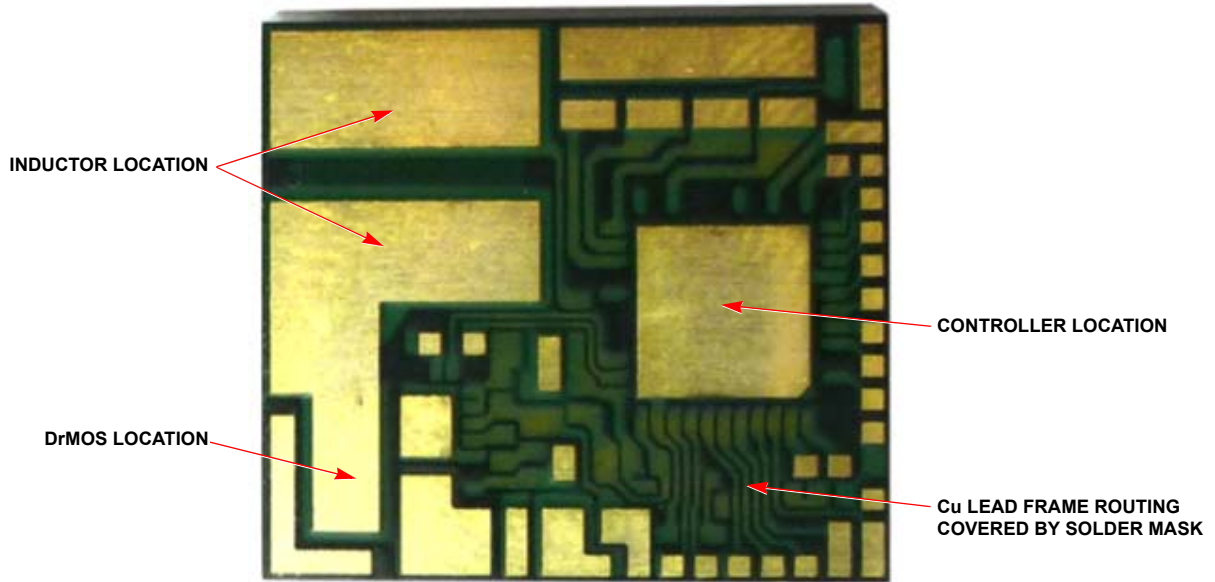

FIGURE 2. TYPICAL HDA BOTTOM VIEW - ISL8270M

NOTE: All pads are non-solder mask defined and extend above the SM surface. The pad finish is NiPdAu for good solderability. The Au finish is 0.6µin thick to prevent gold embrittlement of the solder joint.

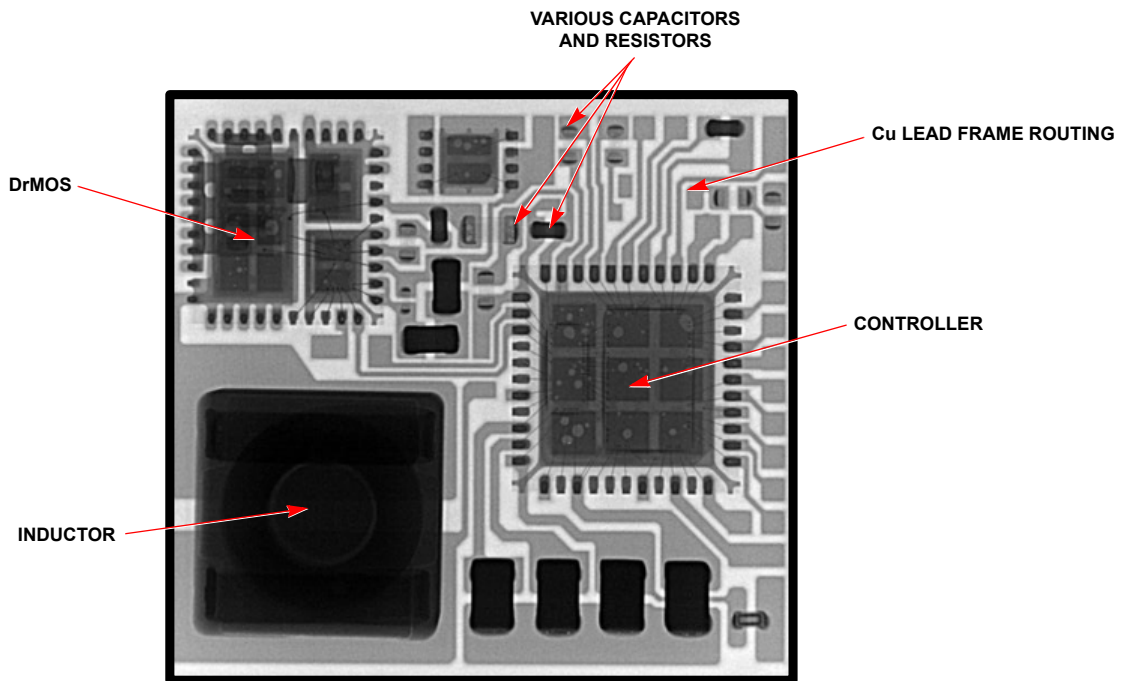

FIGURE 3. TYPICAL HDA MODULE X-RAY - ISL8270M

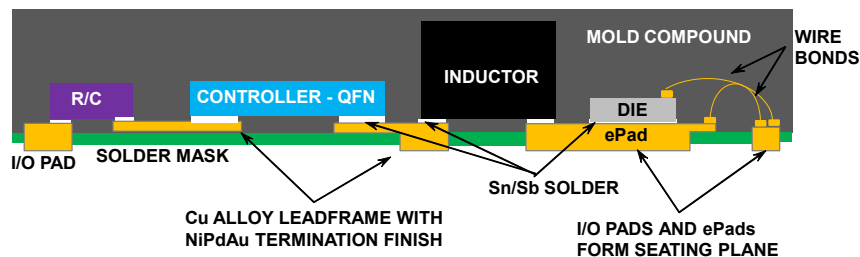

FIGURE 4. TYPICAL HDA MODULE CROSS-SECTION

Moisture Sensitivity

Moisture Sensitivity Handling, Packing, and Use

MOISTURE SENSITIVITY

Intersil HDA modules are moisture-sensitive devices. All Intersil HDA modules meet Moisture Sensitivity Level (MSL) 3 per J-STD-020.

Pb-free reflow is qualified per J-STD-020. Peak temperatures vary based on module thickness and volume, and are specified on the MSL label and at www.intersil.com.

PACKING AND LABELING

Intersil packs and labels HDA modules per J-STD-033. Standard packing is in JEDEC trays. Add a “-T” to the part number for tape and reel packing. For more information on tape and reel specifications for integrated circuits, see tech brief [TB347](#).

HANDLING AND USE

Customers should handle and use HDA modules per J-STD-033. The modules are MSL 3 qualified – do not exceed 168-hour floor life. If floor life is exceeded, bake at +125 °C for 48 hours.

Reliability

Standard HDA Module Development Flow and Qualification

Prior to the package and/or product builds for qualification (design phase), discrete component reliability reports are reviewed and approved. The Intersil Corporate Process Reliability group tests and/or approves process technology wear-out data (i.e., TDDDB, Hot Carrier, HTRB, EM, etc.) to ensure the process technology for embedded controllers, power FETs, power stage, etc., meet the Intersil wear-out goals.

The package engineering group executes “look-ahead” evaluations to ensure the package is robust and meets design goals. Once the design phase is complete, the HDA power module and package moves into the Product/Package Reliability qualification phase.

Typical Reliability Qualification Stress Tests

- MSL Test – Determines Moisture Sensitivity Level per J-STD-020.
- Precondition Stress – Samples for BHAST, UHAST, THB, and TMCL are preconditioned. Stress includes moisture soak per MSL and three-time reflow cycles at the Pb-free peak reflow temperature, per J-STD-020.
- BHAST or THB – Static bias in a moisture-rich environment. Stress targets possible electrolytic related failure mechanisms. Typical stress runs for 96 hours or 1000 hours, respectively.
- High Temperature Operating Life (HTOL) – Dynamic operation, maximum operating voltage per datasheet. This stress test is used to verify the long term reliability of the module. Data is used to calculate FIT rate and MTF. Typical stress runs for 1000 hours with module temperature set at +125 °C.
- Temperature Cycling (TMCL) – This stress test targets flaws in the thermo-mechanical properties of the module design or BOM. Typical stress includes 500 cycles at -65 °C/+150 °C or 1000 cycles at -40 °C/+125 °C.
- High Temperature Storage Life (HTSL) – This stress test is used as an indicator of thermally activated failure mechanisms. Typical stress runs for 1000 hours at 150 °C.
- Unbiased HAST (UHAST) – This stress test accelerates the penetration of moisture through a protective mold compound and is used to identify failure mechanisms internal to the package, such as galvanic corrosion. Typical stress runs for 96 hours at +130 °C/85% RH, 2ATM pressure.
- Reliability reports available on www.intersil.com/support

Intersil HDA Power Module – Board Level Reliability

Intersil verifies the BLR of HDA modules by:

- Mounting functional modules or daisy chain modules on PCBs
- Using SAC 305 or SnPb solder
- Performing temperature cycles of -40°C to $+125^{\circ}\text{C}$, 12-minute dwell (typical)
- Running 2000 cycles (typical)
- Conducting down point and end point electrical tests to confirm module functionality or no resistance change
- Testing end point cross section to confirm no solder joint damage

A summary of BLR data is available at www.intersil.com. Detailed reports are also available. Contact Intersil Sales to request a detailed BLR report.

PCB Design Guidelines

HDA – PCB Design Guidelines

- The Intersil HDA package outline drawing in the product datasheet includes a PCB footprint and solder stencil
- PCB lands in the form of SMD pads are preferred to improve gasketing
- PCB lands should match the HDA pads one-to-one
- Large ePads should be “windowpaned” with SM
 - The SM webs provide gasketing to improve solder release during printing, control solder spread/thickness, and provide venting for out-gassing during reflow
 - See the Package Outline Drawing (POD) for specific design recommendations
- Solder stencil apertures should be slightly smaller than the solder mask openings, 30 μm typical.
- Via in pad should be filled and plated over (VIPPO) to prevent solder wicking into the vias.
- Electroless Nickel Immersion Gold (ENIG) PCB finish recommended

PCB Assembly Process

HDA – PCB Assembly Process

- Profile with a thermal couple placed under the HDA module
- Follow solder paste supplier's reflow profile, but do not exceed HDA module's qualified peak reflow temp. Pb-free reflow is qualified per J-STD-020:
 - Peak temperature varies based on module thickness and volume
 - Peak temperature specified on MSL label or www.intersil.com
- Do not exceed 168-hour out of bag limit (MSL 3 qualified)
 - If time limit exceeded bake per MSL label instructions
- Solder foil preforms may be used on large ePads to reduce solder voids and flux residue and to increase stand-off height
- Use the following assembly tooling materials for the SMT process:
 - Electroless Nickel Immersion Gold PCB finish (ENIG)
 - Stainless steel, laser cut stencils with Nano-coating
 - 4 mil or 5 mil stencil thickness
 - No clean, low void, Type 3 or 4 solder paste per ANSI/J-STD-005
- Follow paste suppliers recommendation for air or nitrogen purge during reflow
- Solder Print Inspection (SPI) is recommended to ensure consistent solder deposit area, height, and volume

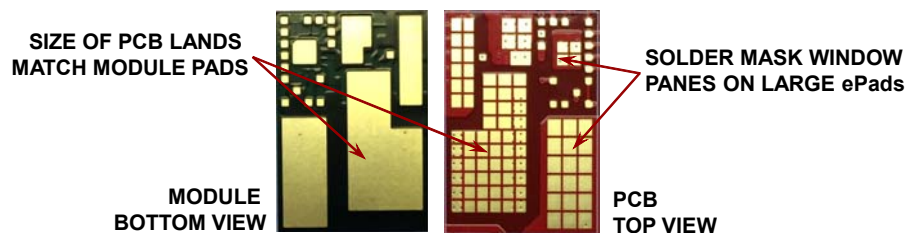

FIGURE 5. TYPICAL HDA MODULE PHOTOS

ISL8272M/ISL8273M Validated SMT Process Summary**TABLE 1. SCREEN PRINT**

MACHINE		MATERIALS	
Screen Printer	DEK Horizon O2i	Solder Paste	Alpha CVP-390 SAC 305
Pressure	8Kg	Thawing Time	4 hrs
Speed	15mm/sec	Auto Mix Time	3 min
Single/Dual Print	Single	TOOLING	
Separate Speed	0.3mm/sec	Stencil Thickness	5 mils
Separate Distance	2mm	Stencil Opening	Per POD
Printing Gap	0mm	Stencil Made	Laser cut + electro polishing

TABLE 2. COMPONENT PLACEMENT

MACHINE		MATERIALS	
Chip Shooter	Yamaha YG100G	Components	Intersil 8272M Modules
Pick-up Speed	30%	Packing	JEDEC Tray
Place Speed	30%	Pre-Bake	NO
Transport Speed	50%	TOOLING	
Place Height	0.2mm	Feeder	Tray Loader
Vacuum Level	30%	Nozzle	214

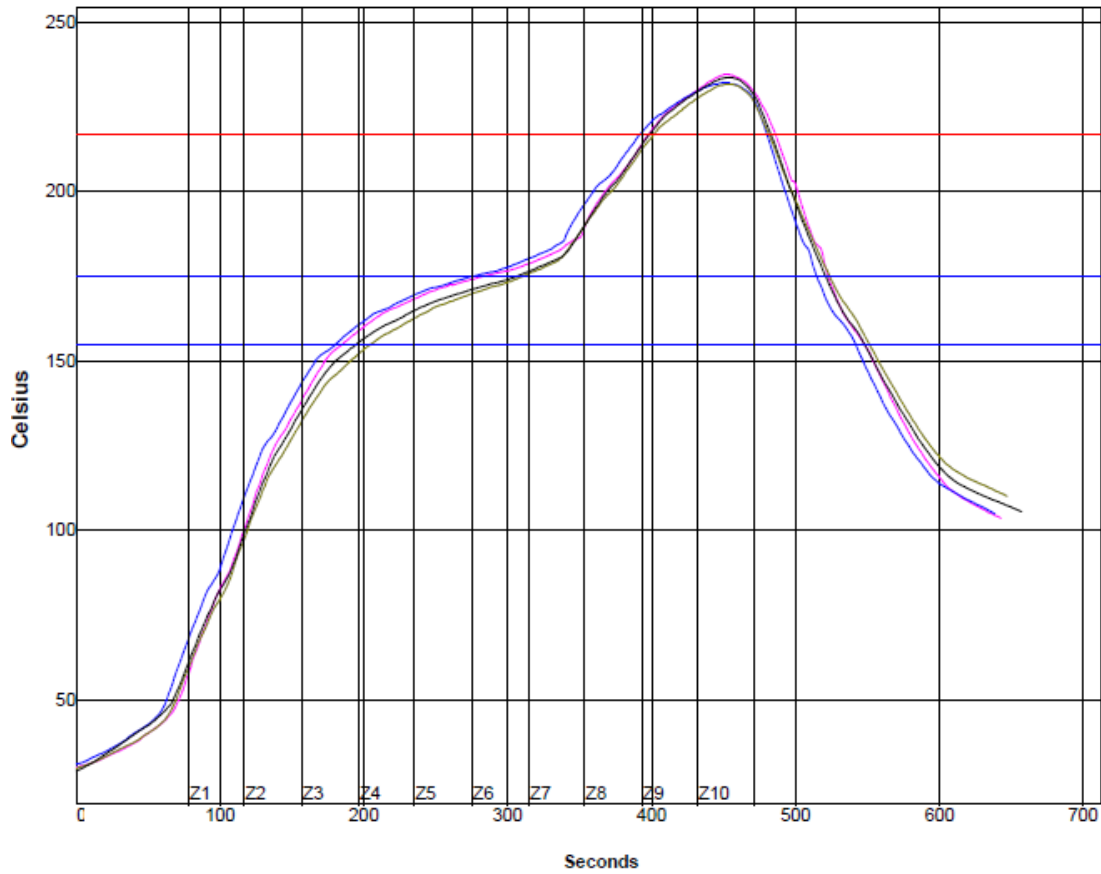

PWI= 163%	Max Rising Slope	Max Falling Slope	Soak Time 155-175C	Reflow Time /217C	Peak Temp					
TC1	1.19	63%	-1.18	93%	97.81	89%	88.11	87%	234.62	-108%
TC2	1.19	65%	-1.27	89%	95.20	76%	88.14	88%	232.21	-156%
TC3	1.11	36%	-1.02	99%	105.38	127%	79.90	33%	231.83	-163%
TC4	1.13	42%	-1.14	95%	111.46	157%	84.41	63%	233.73	-125%
Delta	0.08		0.25		16.26		8.24		2.79	

STATISTIC NAME	LOW LIMIT	HIGH LIMIT	UNITS
Max Rising Slope (Target = 1.0) (calculate slope over 30 seconds)	0.7	1.3	Degrees/Second
Max Falling Slope (calculate slope over 30 seconds)	-6.0	-1.0	Degrees/Second
Soak Time +155 °C to +175 °C	60	100	Seconds
Time Above Reflow -217 °C	60	90	Seconds
Peak Temperature	235	245	°C

ISL8272M, ISL8273M Validated SMT Process

PCBA Solder Joint Voiding Recommendations

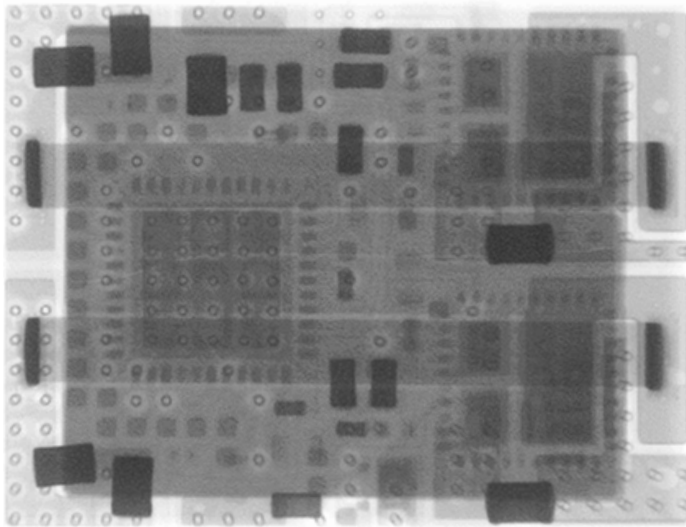

FIGURE 6. ISL8272M, ISL8273M SAMPLE X-RAY

- There are no IPC standards for solder joint voids for bottom-terminated components
- Intersil recommends 25% maximum solder void for small I/O pads and 50% maximum solder void for large epads
- Solder voids have minimal impact on thermal performance as shown in [Figure 7](#)

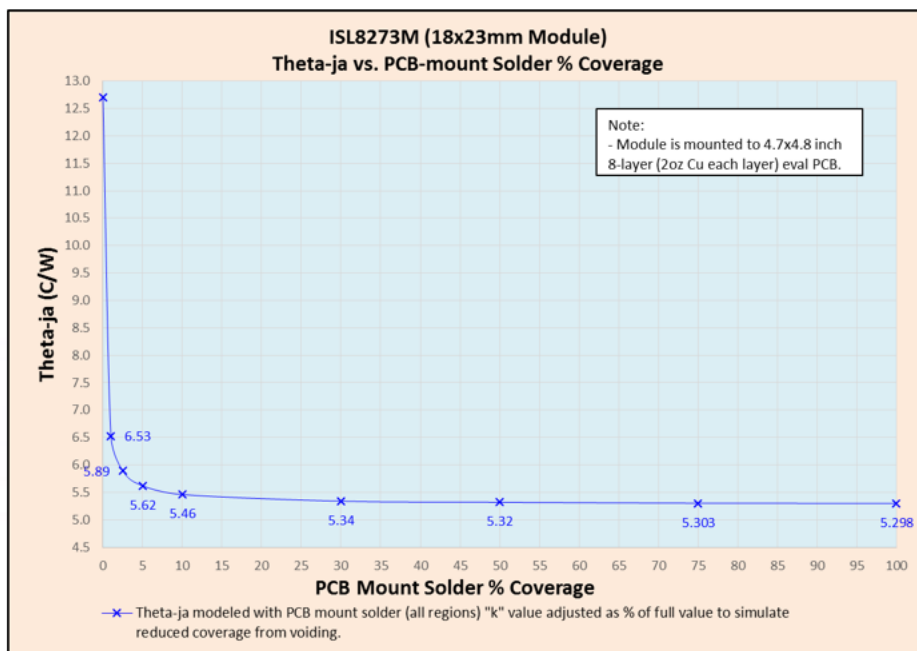

FIGURE 7. θ_{JA} vs PCB-MOUNT SOLDER % COVERAGE

PCBA Rework

For rework of defects underneath the package, the whole package needs to be removed.

Removal and rework of HDAs should be done on a rework station with thermal profile control (see [Figure 8](#)). The following steps are provided as a guideline – a starting point in developing a successful rework process.



FIGURE 8. REWORK STATION WITH THERMAL PROFILE CONTROL

Bake

Before rework, bake the PCB assembly at +125°C for at least 48 hours to remove any residual moisture.

Component Removal

Ideally, the reflow profile for part removal should be similar to that of the component attachment. However, the time above liquidus can be reduced as long as the reflow is complete. Typical rework stations will heat the board from the bottom side using convective heaters and from the top side with a hot gas nozzle directing heat at the component to be removed (see [Figure 9](#)). An appropriate thermal profile must be developed to preheat, soak, and reflow the module on the PCB.

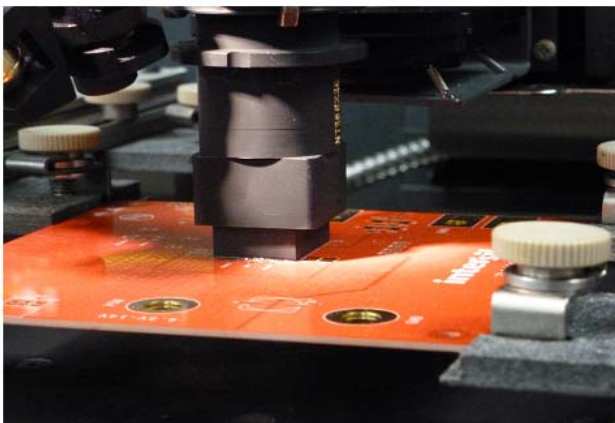

FIGURE 9. TOP AND BOTTOM PREHEAT

Component Removal – Reflow

The circuit-board component being removed should reach at least +55°C ± 5°C using a temperature ramp of +1°C to +3°C/min before ramping to reflow temperature (see [Figure 10](#)).

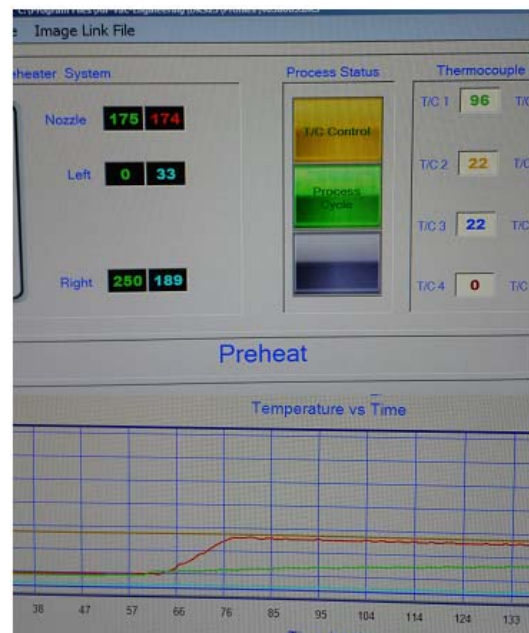

FIGURE 10. PREHEAT CONTROL

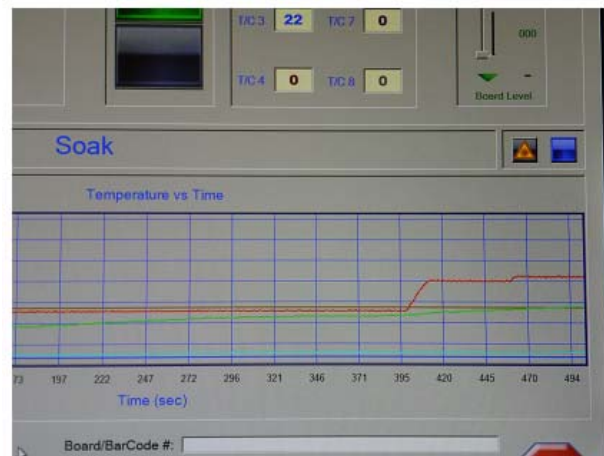

FIGURE 11. REFLOW TEMPERATURE CONTROL

Peak temperature is dependent on the solder composition. Minimize heating of adjacent components by using the lowest peak temperature needed to reflow the solder joints.

Once the joints have reflowed, the HDA is removed with a vacuum pick-up (see [Figure 12](#)).

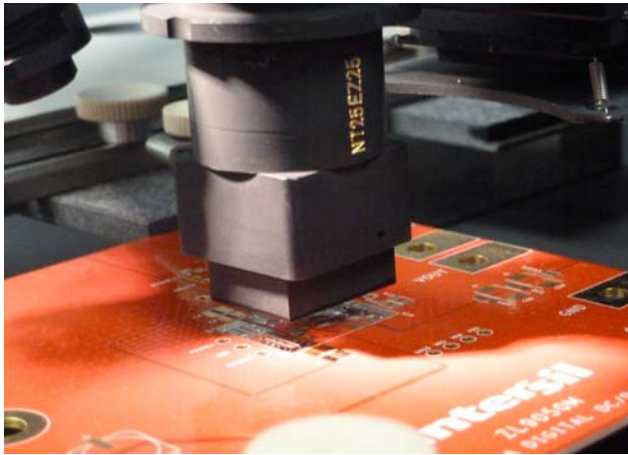

FIGURE 12. COMPONENT REMOVED WITH VACUUM PICK-UP

Site Redress

Clean the site properly, removing residual solder with an appropriate vacuum nozzle. Use the site redress program provided by the rework station (see [Figures 13 and 14](#)).

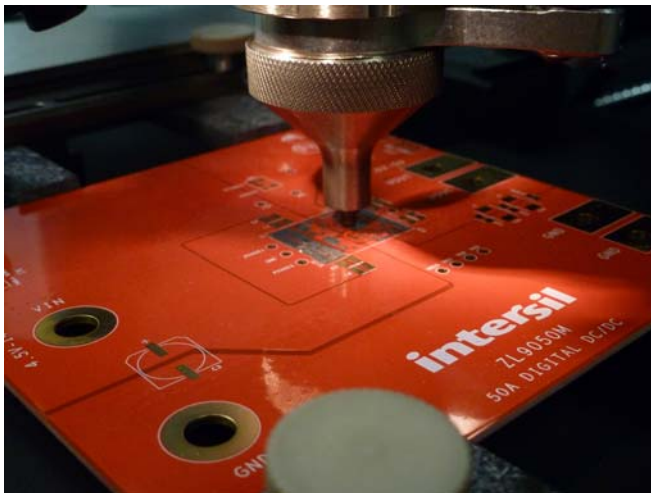

FIGURE 13. SITE REDRESS

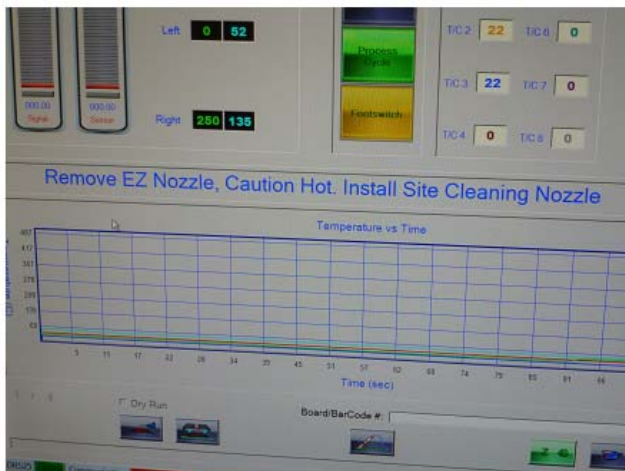

FIGURE 14. REDRESS PROGRAM

Solder Paste Printing

Use a miniature stencil specific to the HDA component (see [Figure 15](#)). Align and attach the stencil to the component using a stereo microscope (see [Figure 16](#)). Deposit a small amount of paste on the stencil and use a small squeegee blade to print the paste onto the component (see [Figure 17](#)).

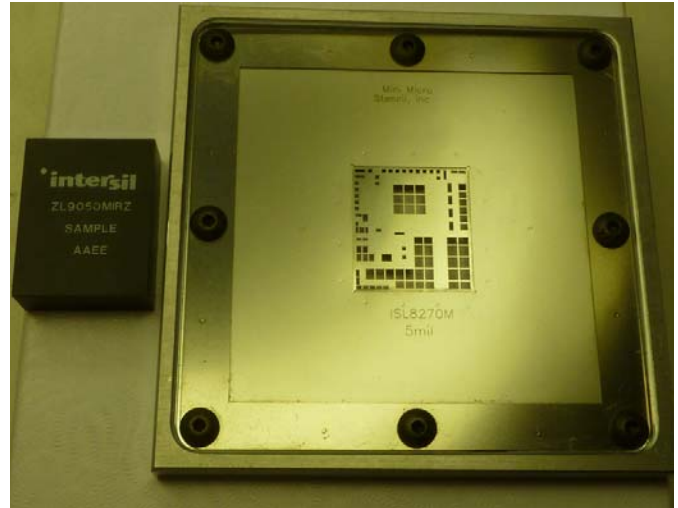

FIGURE 15. MINIATURE STENCIL

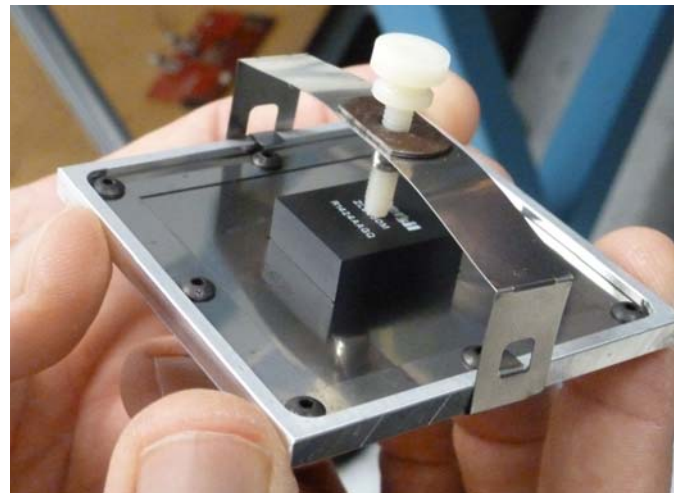

FIGURE 16. ALIGN STENCIL ONTO REPLACEMENT MODULE



FIGURE 17. DEPOSIT PASTE WITH SMALL SQUEEGEE BLADE

Component Alignment and Placement

Carefully place the HDA module in the pick-up position (see [Figure 18](#)).

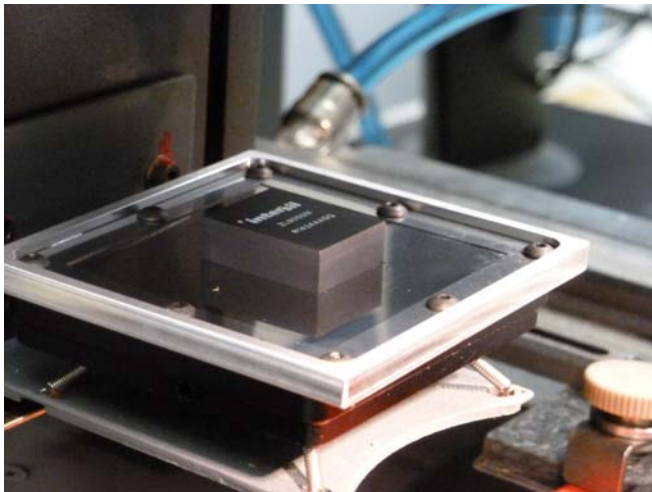

FIGURE 18. PLACEMENT OF NEW DEVICE

Use the rework station's optical system overlay and align the images of the HDA terminals with the printed solder and PCB land pattern (see [Figure 19](#)).



FIGURE 19. OVERLAY IMAGE ALIGNMENT

Component Reflow

Reflow the component using the same reflow profile as originally developed for the PCBA based on the solder paste used (see [Figure 20](#)). The rework is completed (see [Figure 21](#)).

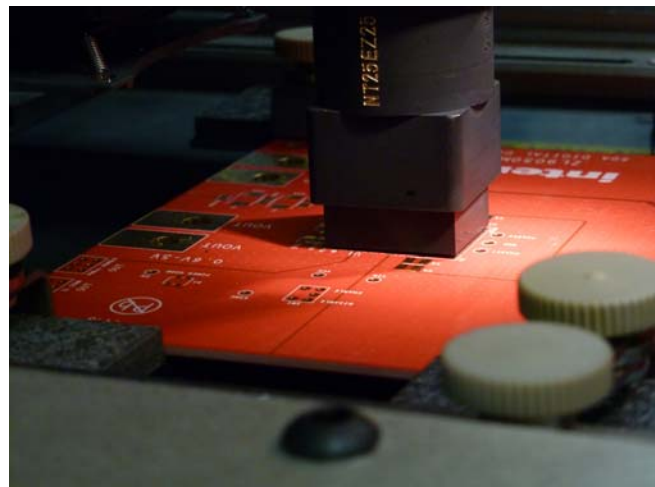

FIGURE 20. COMPONENT PLACEMENT

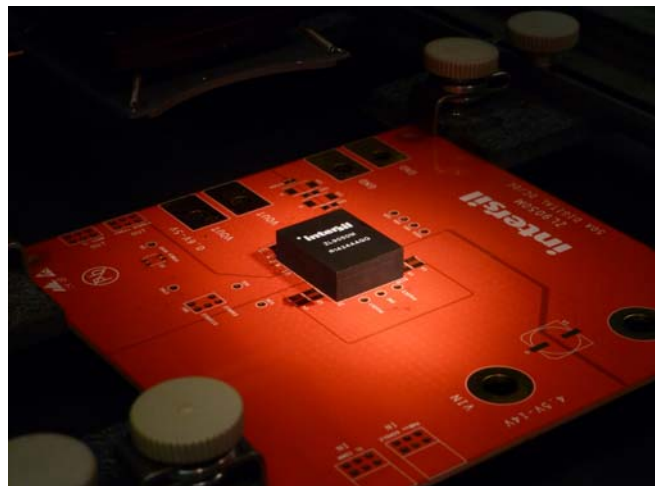

FIGURE 21. COMPLETED REWORK

Questions and Answers

- What is HDA?
 - High Density Array (HDA) is a unique, Intersil developed, module packaging technology based on a routable, copper (Cu) lead frame construction, which provides superior thermal performance compared to laminate substrate based modules.
- Can HDA modules be reworked?
 - Yes, a rework station used for BGA rework is recommended. See [“PCBA Rework” on page 8.](#)
- Can HDA modules be mounted on the bottom side of the PCBA?
 - HDAs with a maximum thickness of 2.5mm and 3.7mm may be mounted on the PCBA bottom side. HDAs with 5.3mm and 7.5mm maximum thickness are not recommended for bottom side mounting.
- What is the maximum amount of solder voiding allowed?
 - See discussion in [“PCBA Solder Joint Voiding Recommendations” on page 7.](#)

Notice

1. Descriptions of circuits, software and other related information in this document are provided only to illustrate the operation of semiconductor products and application examples. You are fully responsible for the incorporation or any other use of the circuits, software, and information in the design of your product or system. Renesas Electronics disclaims any and all liability for any losses and damages incurred by you or third parties arising from the use of these circuits, software, or information.
2. Renesas Electronics hereby expressly disclaims any warranties against and liability for infringement or any other claims involving patents, copyrights, or other intellectual property rights of third parties, by or arising from the use of Renesas Electronics products or technical information described in this document, including but not limited to, the product data, drawings, charts, programs, algorithms, and application examples.
3. No license, express, implied or otherwise, is granted hereby under any patents, copyrights or other intellectual property rights of Renesas Electronics or others.
4. You shall not alter, modify, copy, or reverse engineer any Renesas Electronics product, whether in whole or in part. Renesas Electronics disclaims any and all liability for any losses or damages incurred by you or third parties arising from such alteration, modification, copying or reverse engineering.
5. Renesas Electronics products are classified according to the following two quality grades: "Standard" and "High Quality". The intended applications for each Renesas Electronics product depends on the product's quality grade, as indicated below.
"Standard": Computers; office equipment; communications equipment; test and measurement equipment; audio and visual equipment; home electronic appliances; machine tools; personal electronic equipment; industrial robots; etc.
"High Quality": Transportation equipment (automobiles, trains, ships, etc.); traffic control (traffic lights); large-scale communication equipment; key financial terminal systems; safety control equipment; etc.
Unless expressly designated as a high reliability product or a product for harsh environments in a Renesas Electronics data sheet or other Renesas Electronics document, Renesas Electronics products are not intended or authorized for use in products or systems that may pose a direct threat to human life or bodily injury (artificial life support devices or systems; surgical implantations; etc.), or may cause serious property damage (space system; undersea repeaters; nuclear power control systems; aircraft control systems; key plant systems; military equipment; etc.). Renesas Electronics disclaims any and all liability for any damages or losses incurred by you or any third parties arising from the use of any Renesas Electronics product that is inconsistent with any Renesas Electronics data sheet, user's manual or other Renesas Electronics document.
6. When using Renesas Electronics products, refer to the latest product information (data sheets, user's manuals, application notes, "General Notes for Handling and Using Semiconductor Devices" in the reliability handbook, etc.), and ensure that usage conditions are within the ranges specified by Renesas Electronics with respect to maximum ratings, operating power supply voltage range, heat dissipation characteristics, installation, etc. Renesas Electronics disclaims any and all liability for any malfunctions, failure or accident arising out of the use of Renesas Electronics products outside of such specified ranges.
7. Although Renesas Electronics endeavors to improve the quality and reliability of Renesas Electronics products, semiconductor products have specific characteristics, such as the occurrence of failure at a certain rate and malfunctions under certain use conditions. Unless designated as a high reliability product or a product for harsh environments in a Renesas Electronics data sheet or other Renesas Electronics document, Renesas Electronics products are not subject to radiation resistance design. You are responsible for implementing safety measures to guard against the possibility of bodily injury, injury or damage caused by fire, and/or danger to the public in the event of a failure or malfunction of Renesas Electronics products, such as safety design for hardware and software, including but not limited to redundancy, fire control and malfunction prevention, appropriate treatment for aging degradation or any other appropriate measures. Because the evaluation of microcomputer software alone is very difficult and impractical, you are responsible for evaluating the safety of the final products or systems manufactured by you.
8. Please contact a Renesas Electronics sales office for details as to environmental matters such as the environmental compatibility of each Renesas Electronics product. You are responsible for carefully and sufficiently investigating applicable laws and regulations that regulate the inclusion or use of controlled substances, including without limitation, the EU RoHS Directive, and using Renesas Electronics products in compliance with all these applicable laws and regulations. Renesas Electronics disclaims any and all liability for damages or losses occurring as a result of your noncompliance with applicable laws and regulations.
9. Renesas Electronics products and technologies shall not be used for or incorporated into any products or systems whose manufacture, use, or sale is prohibited under any applicable domestic or foreign laws or regulations. You shall comply with any applicable export control laws and regulations promulgated and administered by the governments of any countries asserting jurisdiction over the parties or transactions.
10. It is the responsibility of the buyer or distributor of Renesas Electronics products, or any other party who distributes, disposes of, or otherwise sells or transfers the product to a third party, to notify such third party in advance of the contents and conditions set forth in this document.
11. This document shall not be reprinted, reproduced or duplicated in any form, in whole or in part, without prior written consent of Renesas Electronics.
12. Please contact a Renesas Electronics sales office if you have any questions regarding the information contained in this document or Renesas Electronics products.
(Note 1) "Renesas Electronics" as used in this document means Renesas Electronics Corporation and also includes its directly or indirectly controlled subsidiaries.
(Note 2) "Renesas Electronics product(s)" means any product developed or manufactured by or for Renesas Electronics.

(Rev.4.0-1 November 2017)



SALES OFFICES

Renesas Electronics Corporation

<http://www.renesas.com>

Refer to "<http://www.renesas.com/>" for the latest and detailed information.

Renesas Electronics America Inc.
1001 Murphy Ranch Road, Milpitas, CA 95035, U.S.A.
Tel: +1-408-432-8888, Fax: +1-408-434-5351

Renesas Electronics Canada Limited
9251 Yonge Street, Suite 8309 Richmond Hill, Ontario Canada L4C 9T3
Tel: +1-905-237-2004

Renesas Electronics Europe Limited
Dukes Meadow, Millboard Road, Bourne End, Buckinghamshire, SL8 5FH, U.K
Tel: +44-1628-651-700, Fax: +44-1628-651-804

Renesas Electronics Europe GmbH
Arcadiastrasse 10, 40472 Düsseldorf, Germany
Tel: +49-211-6503-0, Fax: +49-211-6503-1327

Renesas Electronics (China) Co., Ltd.
Room 1709 Quantum Plaza, No.27 ZhichunLu, Haidian District, Beijing, 100191 P. R. China
Tel: +86-10-8235-1155, Fax: +86-10-8235-7679

Renesas Electronics (Shanghai) Co., Ltd.
Unit 301, Tower A, Central Towers, 555 Langao Road, Putuo District, Shanghai, 200333 P. R. China
Tel: +86-21-2226-0888, Fax: +86-21-2226-0999

Renesas Electronics Hong Kong Limited
Unit 1601-1611, 16/F., Tower 2, Grand Century Place, 193 Prince Edward Road West, Mongkok, Kowloon, Hong Kong
Tel: +852-2265-6688, Fax: +852-2886-9022

Renesas Electronics Taiwan Co., Ltd.
13F, No. 363, Fu Shing North Road, Taipei 10543, Taiwan
Tel: +886-2-8175-9600, Fax: +886-2-8175-9670

Renesas Electronics Singapore Pte. Ltd.
80 Bendemeer Road, Unit #06-02 Hyflux Innovation Centre, Singapore 339949
Tel: +65-6213-0200, Fax: +65-6213-0300

Renesas Electronics Malaysia Sdn.Bhd.
Unit 1207, Block B, Menara Amcorp, Amcorp Trade Centre, No. 18, Jln Persiaran Barat, 46050 Petaling Jaya, Selangor Darul Ehsan, Malaysia
Tel: +60-3-7955-9390, Fax: +60-3-7955-9510

Renesas Electronics India Pvt. Ltd.
No.777C, 100 Feet Road, HAL 2nd Stage, Indiranagar, Bangalore 560 038, India
Tel: +91-80-67208700, Fax: +91-80-67208777

Renesas Electronics Korea Co., Ltd.
17F, KAMCO Yangjae Tower, 262, Gangnam-daero, Gangnam-gu, Seoul, 06265 Korea
Tel: +82-2-558-3737, Fax: +82-2-558-5338