

Product Change Notice (PCN)

Subject: Change Shipping Media on Select Package

Publication Date: 10/30/2020

Effective Date: 1/30/2021

Revision Description:

Initial Release

Description of Change:

Renesas is converting shipping media from Tube to Tray on package TSOP-44. The current shipping media in Reel remains unchanged.

An Industrial standard JEDEC shipping tray will be introduced. In addition, one of the Orderable Part# that is presently ship in Tray (Tray part# 124-4725-119) will convert to the new Tray (New Tray part# TR142050). The MOQ and FOI in Tray shipment shall change to 135 units. Refer Appendix A and Appendix B for more information.

Affected Product List: Refer Appendix C.

Reason for Change:

To align the shipping media throughout the entire manufacturing process from Assembly to Shipping.

Impact on Fit, Form, Function, Quality & Reliability:

The change will have no impact on the product form, fit, function, quality, reliability and environmental compliance of the products.

Product Identification:

Shipment starting Jan 30, 2021 onwards.

Qualification Status: Internal qualification completed successfully, available on request

Sample Availability Date: Not applicable

Material Declaration: Available on request

Note:

1. Acknowledgement must be received by Renesas within 30 days or Renesas will consider the change as approved.
2. If timely acknowledgement is provided by Customer, then Customer shall have 90 days from the date of receipt of this PCN to make any objections to this PCN. If Customer fails to make objections to this PCN within 90 days of the receipt of the PCN then Renesas will consider the PCN changes as approved.
3. If customer cannot accept the PCN then customer must provide Renesas with a last time buy demand and purchase order.

For additional information regarding this notice, please contact idt-pcn@lm.renesas.com

Appendix A – MOQ and FOI Changes (Tube to Tray)

Orderable Part#	Current (Shipping Tube)		New (Shipping Tray, part# TR142050)	
	MOQ	FOI	MOQ	FOI
71016S12PHG	260	26	135	135
71016S15PHG	260	26	135	135
71016S15PHGI	260	26	135	135
71016S20PHG	260	26	135	135
71016S20PHGI	260	26	135	135
71V016SA10PHG	260	26	135	135
71V016SA10PHGI	260	26	135	135
71V016SA12PHG	260	26	135	135
71V016SA12PHGI	260	26	135	135
71V016SA15PHG	260	26	135	135
71V016SA15PHGI	260	26	135	135
71V016SA20PHG	260	26	135	135
71V016SA20PHGI	260	26	135	135
71V416L10PHG	156	26	135	135
71V416L10PHGI	130	26	135	135
71V416L12PHG	156	26	135	135
71V416L12PHGI	130	26	135	135
71V416L15PHG	156	26	135	135
71V416L15PHGI	130	26	135	135
71V416S10PHG	156	26	135	135
71V416S10PHGI	130	26	135	135
71V416S12PHG	156	26	135	135
71V416S12PHGI	26	26	135	135
71V416S12PHG/3211	130	26	135	135
71V416S15PHG	156	26	135	135
71V416S15PHG1	130	26	135	135
71V416S15PHGI	130	26	135	135
71V424L10PHG	130	26	135	135
71V424L10PHGI	130	26	135	135
71V424L12PHG	130	26	135	135
71V424L12PHGI	130	26	135	135
71V424L15PHG	156	26	135	135
71V424L15PHGI	130	26	135	135
71V424S10PHG	156	26	135	135
71V424S10PHGI	130	26	135	135
71V424S12PHG	156	26	135	135
71V424S12PHGI	130	26	135	135
71V424S15PHG	156	26	135	135
71V424S15PHGI	130	26	135	135
71V424Y5S15PHG	130	26	135	135

Appendix A – MOQ and FOI Changes (Tray to Tray)

Orderable Part#	Current (Shipping Tray, part# 124-4725-119)		New (Shipping Tray, part# TR142050)	
	MOQ	FOI	MOQ	FOI
71V416L12PHG/3247	96	96	135	135

Appendix B - Shipping Tray Comparison

Descriptions	Current (Shipping Tray, part# 124-4725-119)	New (Shipping Tray, part# TR142050)
Supplier	DAEWON	DAEWON
Tray Material	MPPO	MPPO
Tray Matrix	8x12	9x15
Units Per Tray	96	135
Row Pitch	15.16 mm	13.67 mm
Colum Pitch	25.50 mm	20.42 mm

Appendix C – Affected Product List

71016S12PHG	71V016SA20PHG	71V416S12PHG	71V424L15PHGI
71016S15PHG	71V016SA20PHGI	71V416S12PHG/3211	71V424S10PHG
71016S15PHGI	71V416L10PHG	71V416S12PHGI	71V424S10PHGI
71016S20PHG	71V416L10PHGI	71V416S15PHG	71V424S12PHG
71016S20PHGI	71V416L12PHG	71V416S15PHG1	71V424S12PHGI
71V016SA10PHG	71V416L12PHGI	71V416S15PHGI	71V424S15PHG
71V016SA10PHGI	71V416L12PHG/3247	71V424L10PHG	71V424S15PHGI
71V016SA12PHG	71V416L15PHG	71V424L10PHGI	71V424Y5S15PHG
71V016SA12PHGI	71V416L15PHGI	71V424L12PHG	
71V016SA15PHG	71V416S10PHG	71V424L12PHGI	
71V016SA15PHGI	71V416S10PHGI	71V424L15PHG	

Appendix D - New Shipping Tray

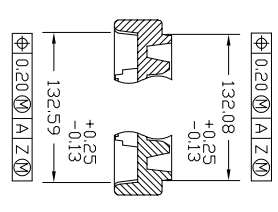
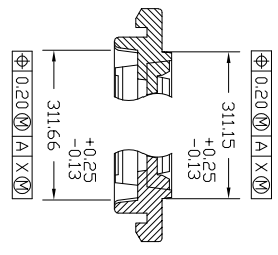
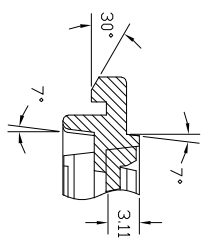
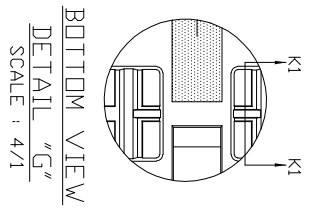
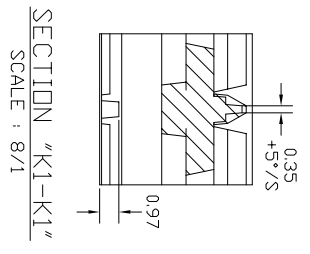
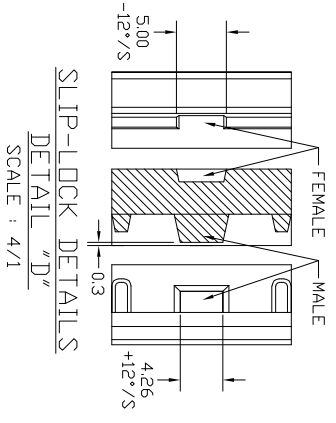
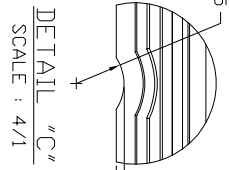
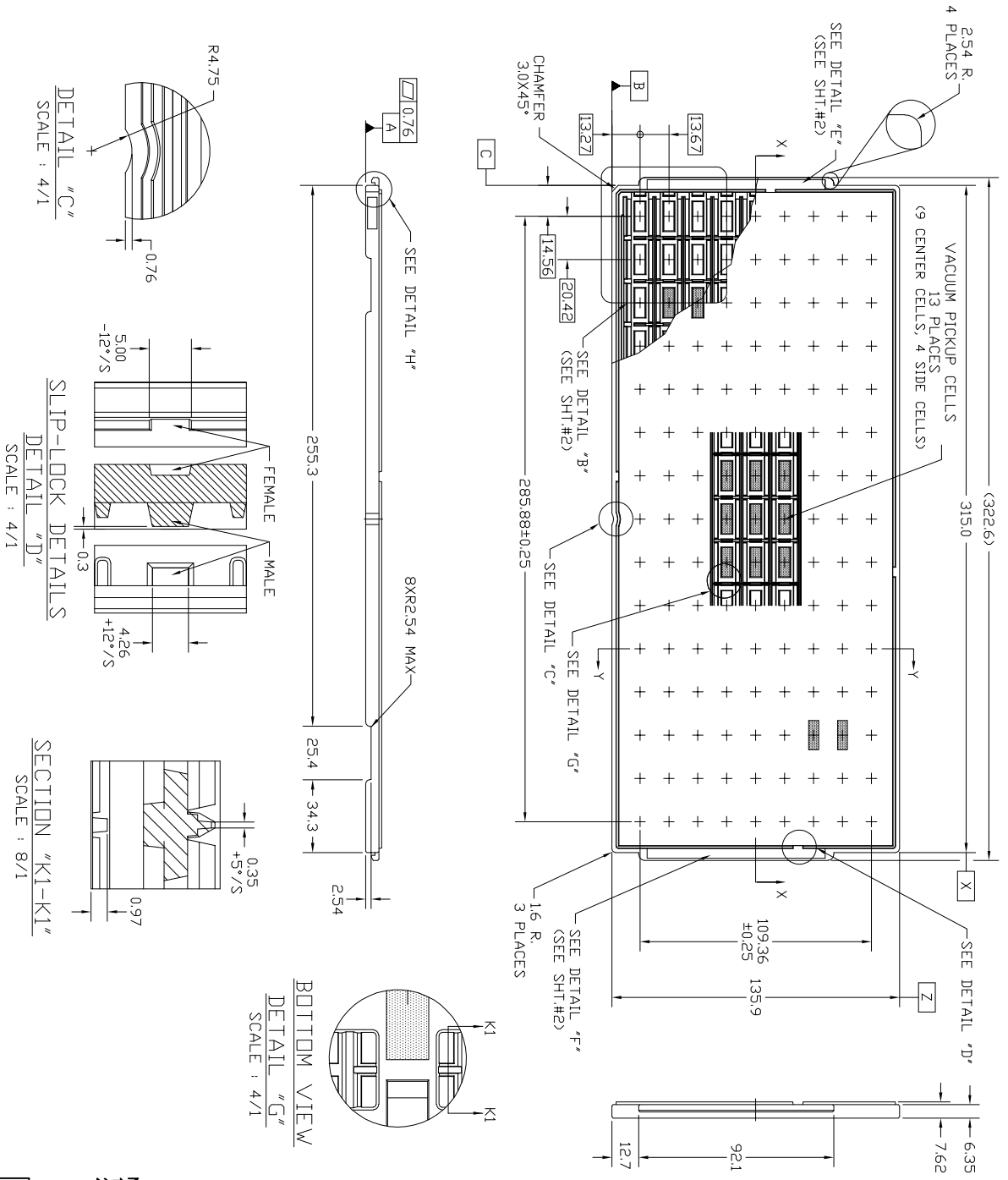

TRAY STACKING DETAIL
SCALE: 3/1

- NOTES: (UNLESS OTHERWISE SPECIFIED)
 1. ALL DIMENSIONS ARE IN MM.
 2. NUMBER OF POCKET: 9 X 15 = 135 POCKETS

TOLERANCES UNLESS OTHERWISE SPECIFIED
 DECIMAL :
 .X ±.25
 .XX ±.13
 .XXX ±
 ANGLE : ±0.5°
 ANGULAR : ±

		6024 Silver Creek Valley Road, San Jose, CA 95138 PHONE: (408) 284-8200 FAX: (408) 284-3572	
TITLE: PHG 44 SHIPPING TRAY			
STOCK NO.	N/A	DRAWING NO.	MSC-8754-A
REV	N/A	SCALE	N/A
DO NOT SCALE DRAWING		SHEET 1 OF 2	

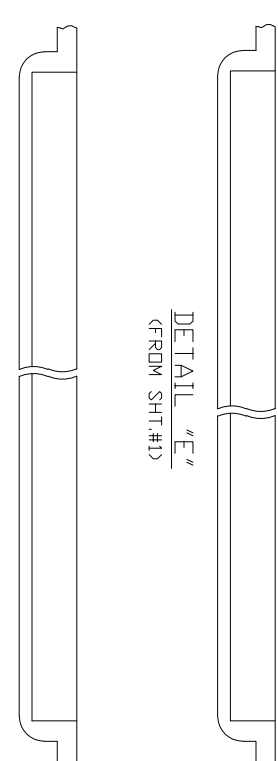
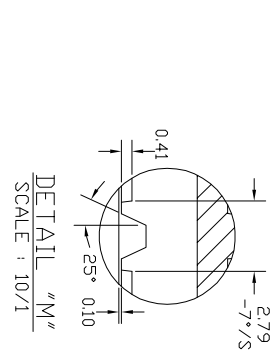
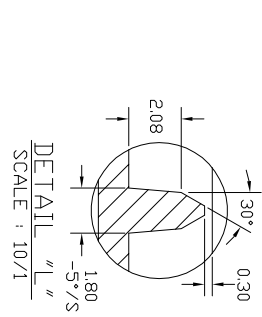
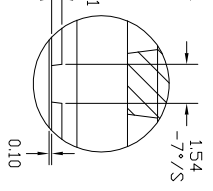
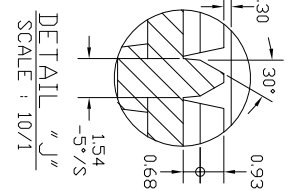
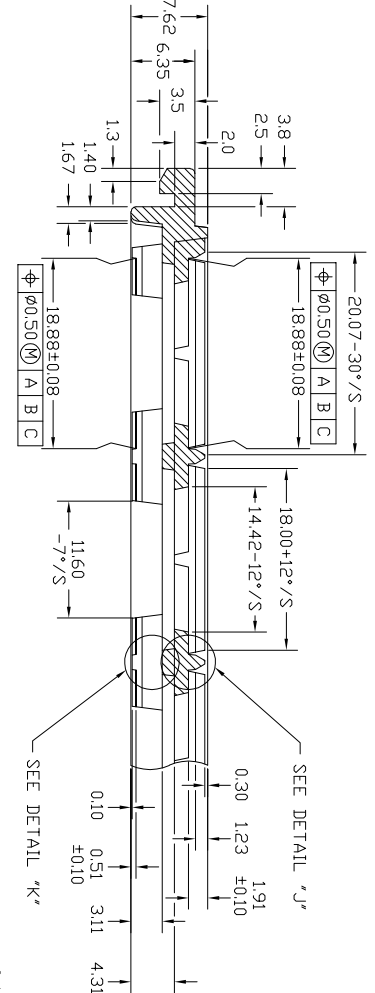
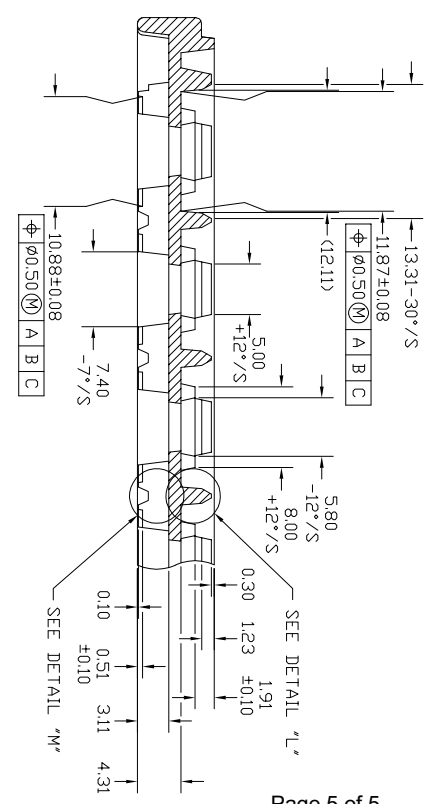
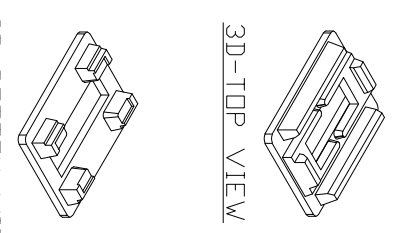
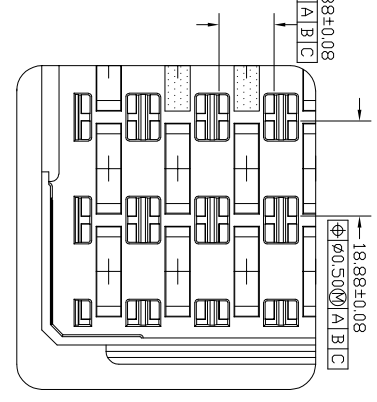
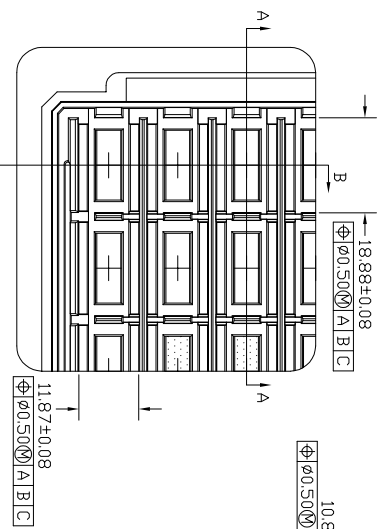

TOLERANCES UNLESS OTHERWISE SPECIFIED
DECIMAL : .X ±.25
.XX ±.13
.XXX ±
ANGLE : ±0.5°
ANGULAR : ±

6024 Silver Creek Valley Road,
San Jose, CA 95138
PHONE: (408) 284-8200
FAX: (408) 284-3572

RENESAS

TITLE:	PHG 44 SHIPPING TRAY	SCALE:	N/A
STOCK NO.	N/A	DRAWING NO.	MSC-8754-A
REV	00	SIZE	N/A
DO NOT SCALE DRAWING	SHEET 2 OF 2	REV	00