

KDC5612EVAL Schematics

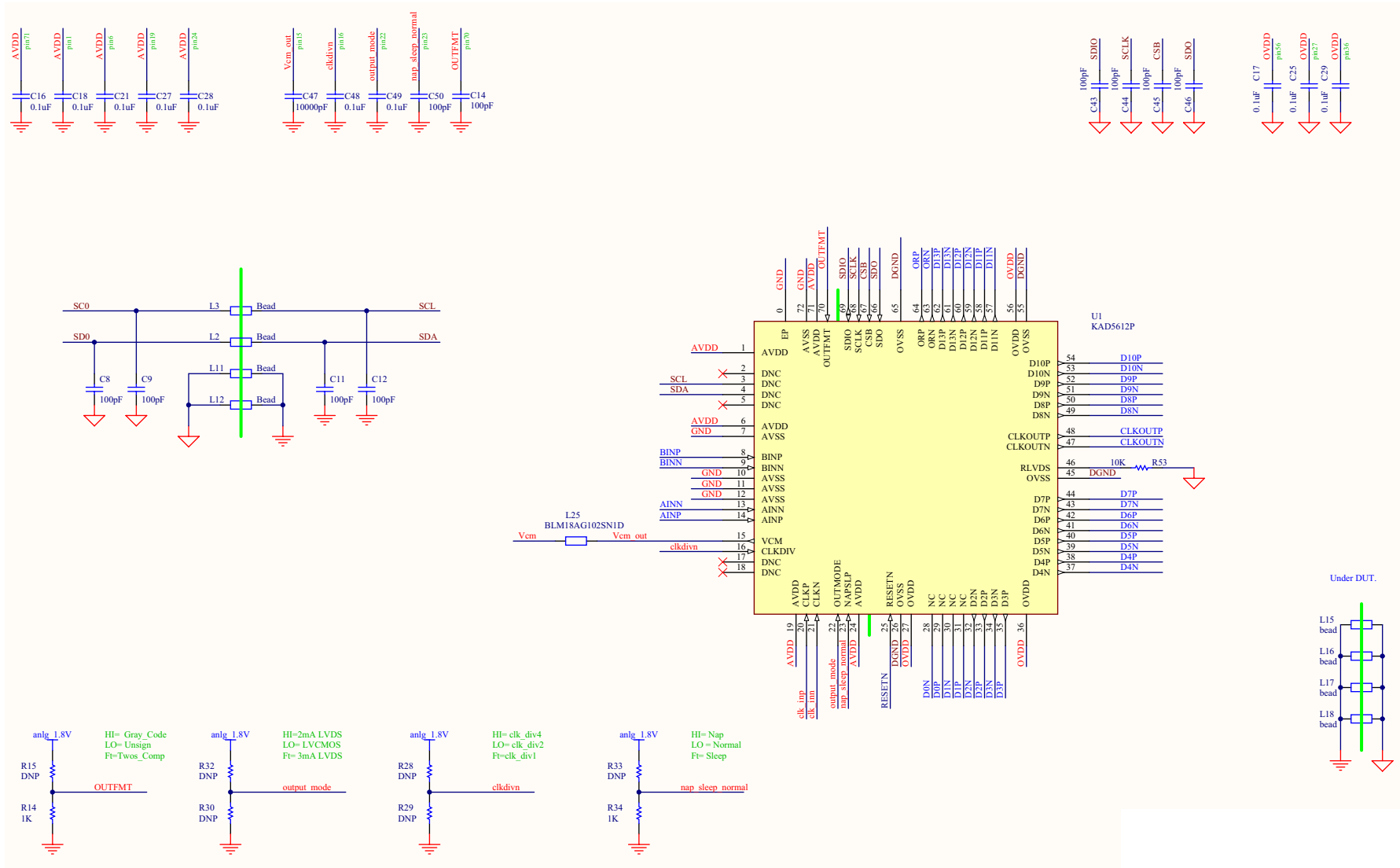

FIGURE 1. ADC, MODE PINS AND POWER SUPPLY BYPASS

KDC5612EVAL Schematics (Continued)

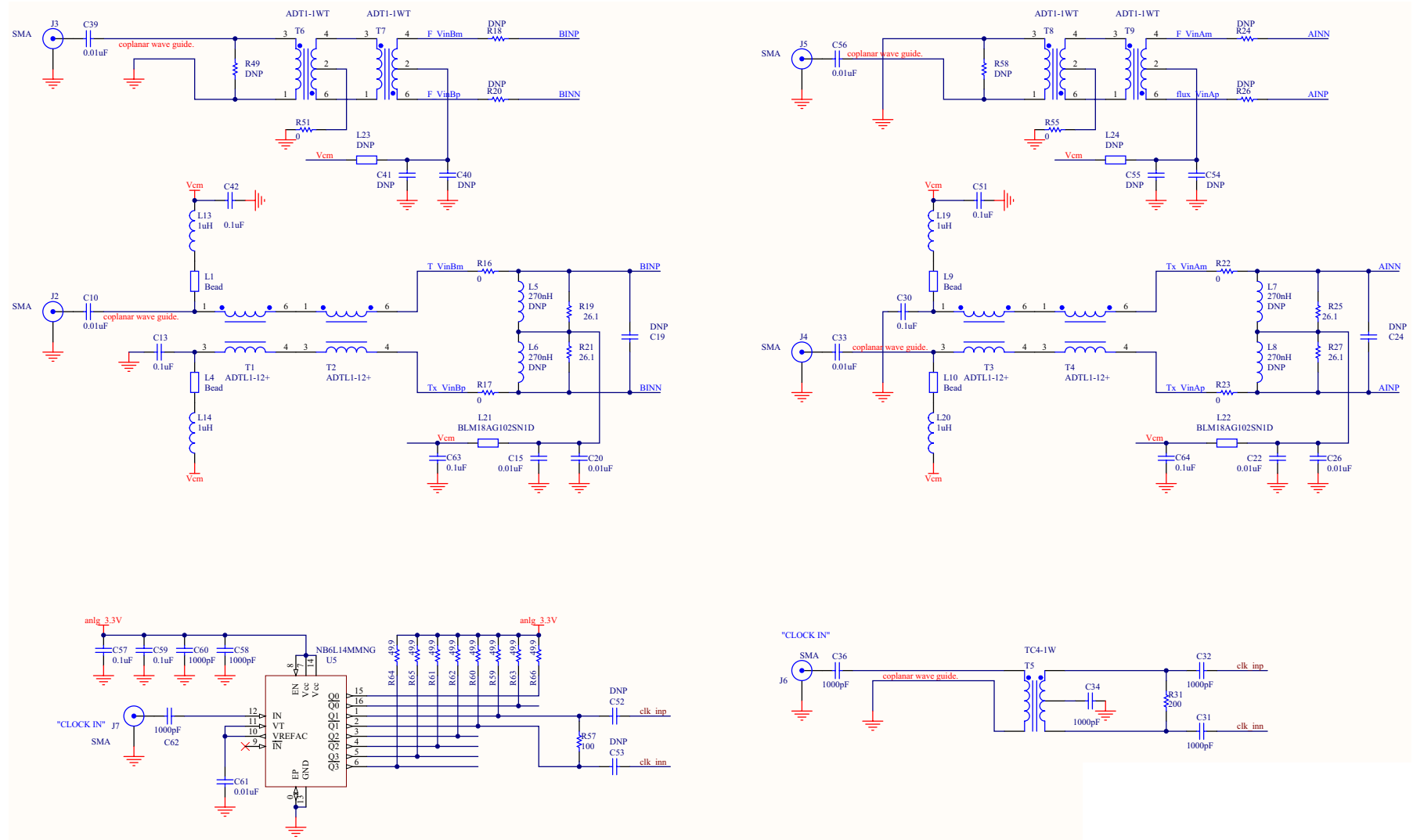

FIGURE 2. CLOCK AND ANALOG INPUTS

KDC5612EVAL Layers

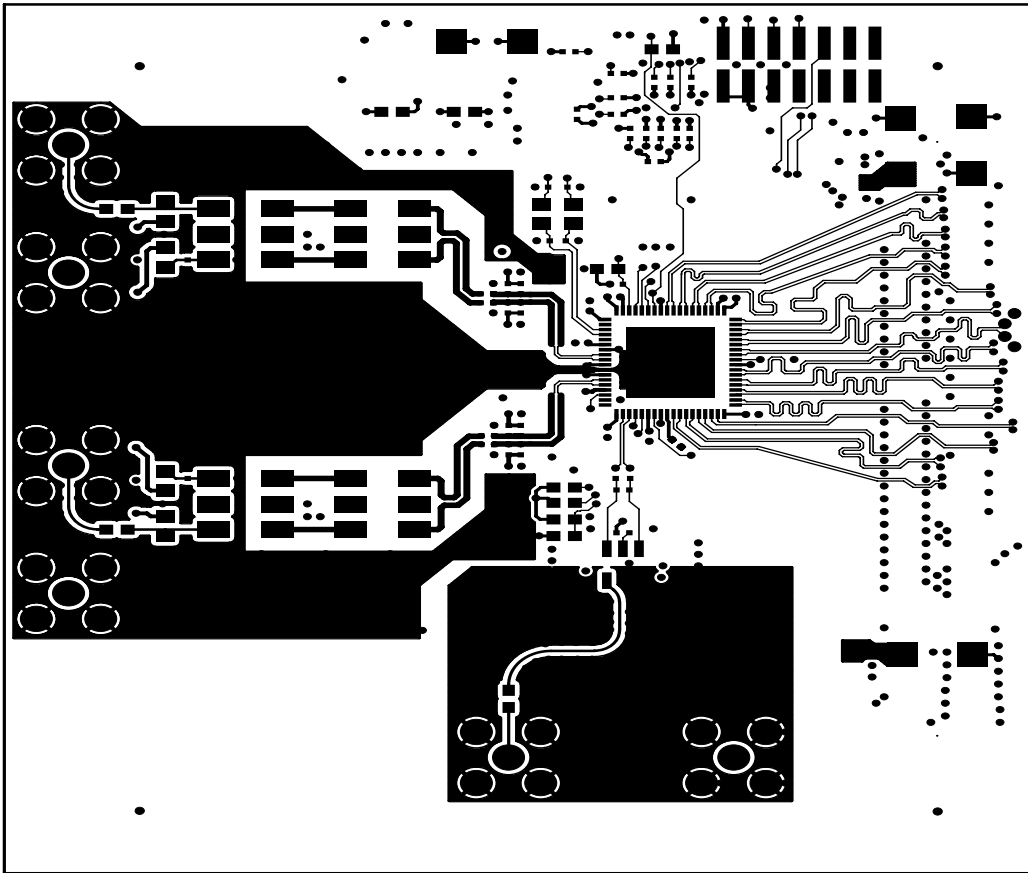

FIGURE 4. PRIMARY SIDE

KDC5612EVAL Layers (Continued)

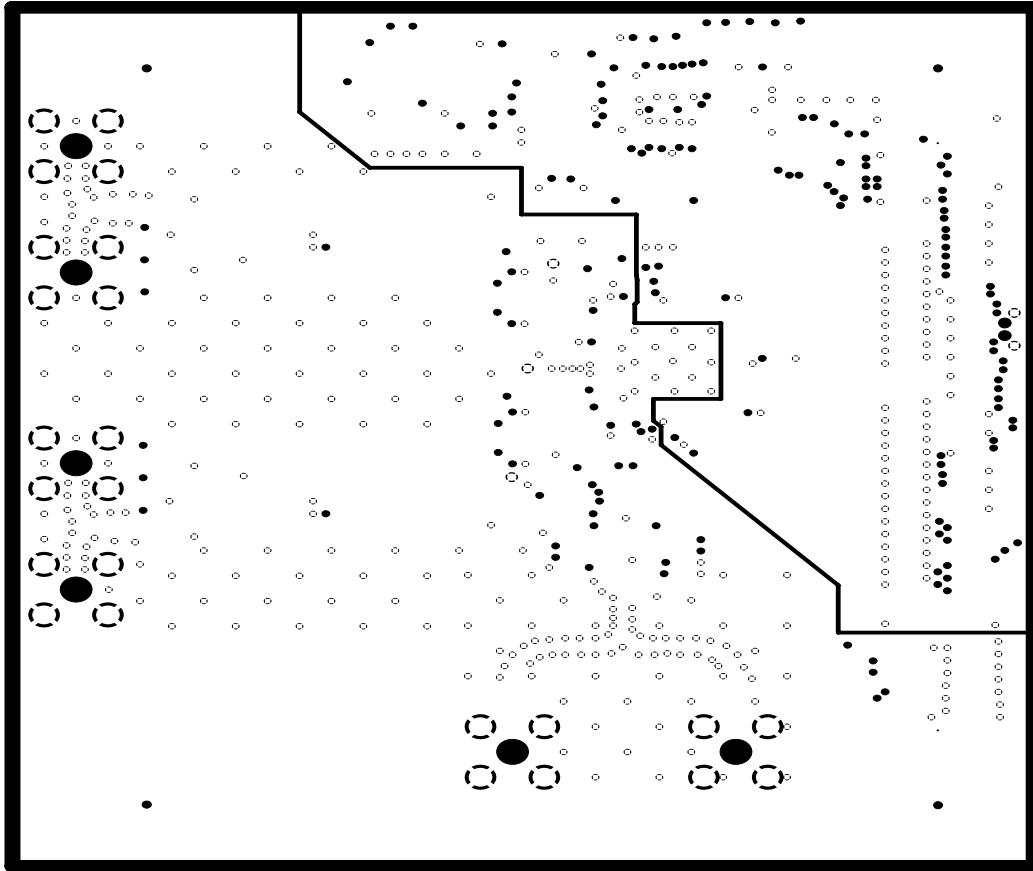

FIGURE 5. GND PLANE 1

KDC5612EVAL Layers (Continued)

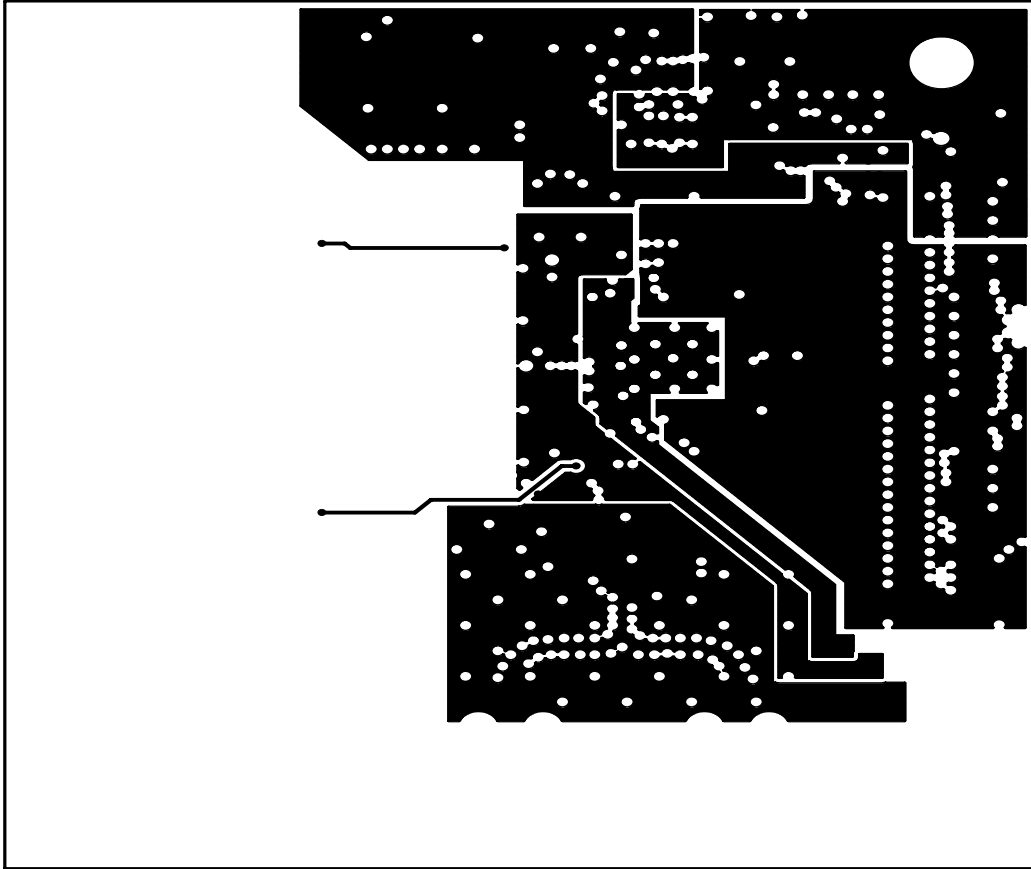

FIGURE 6. PWR PLANE

KDC5612EVAL Layers (Continued)

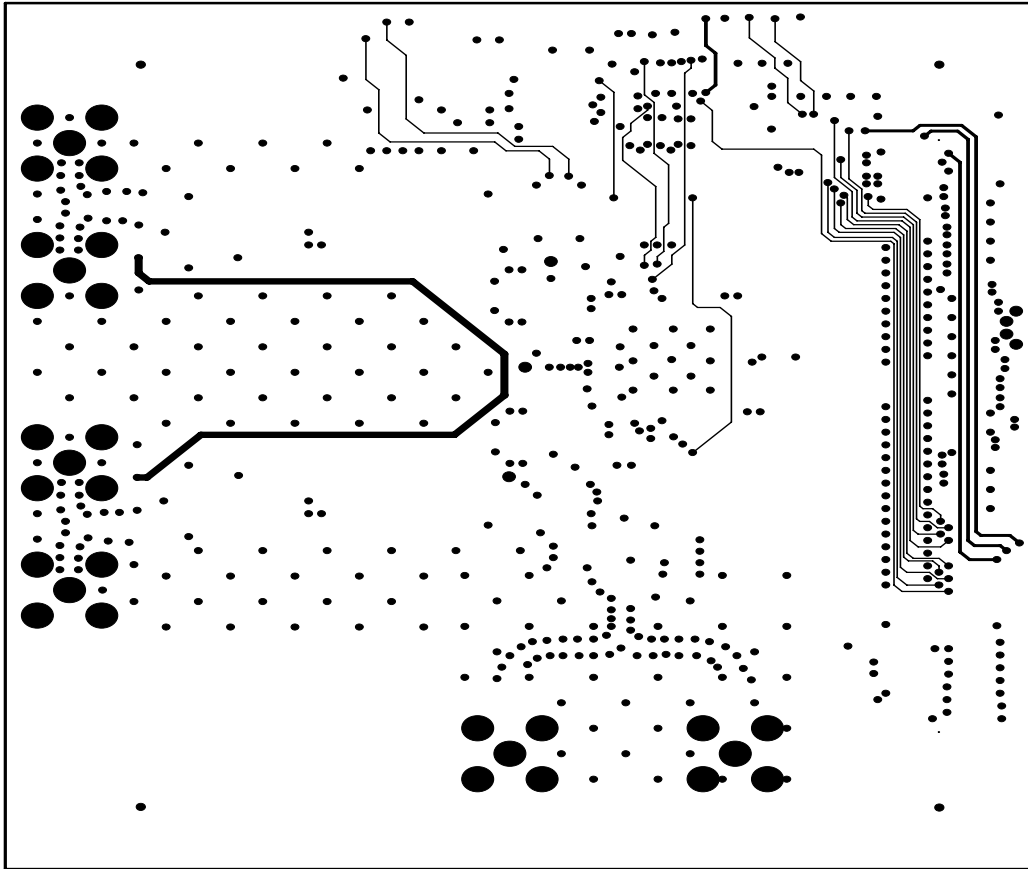

FIGURE 7. INTERNAL SIGNAL

KDC5612EVAL Layers (Continued)

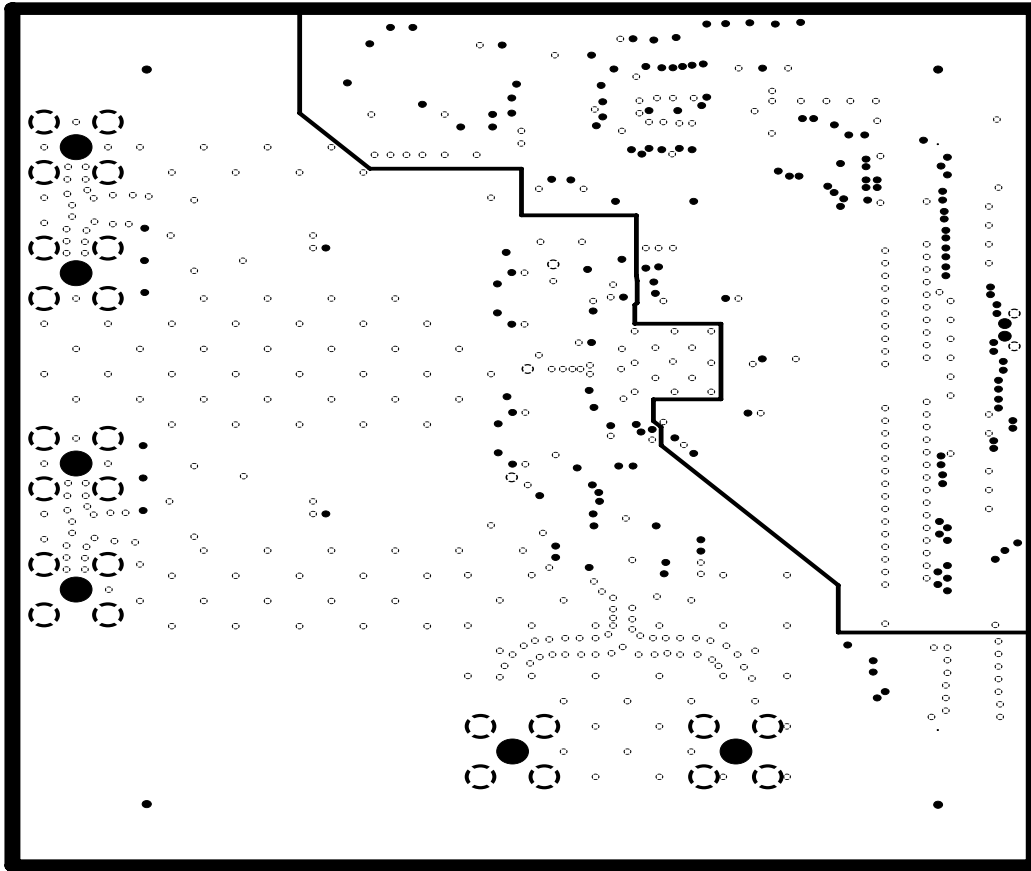

FIGURE 8. GND PLANE 2

KDC5612EVAL Layers (Continued)

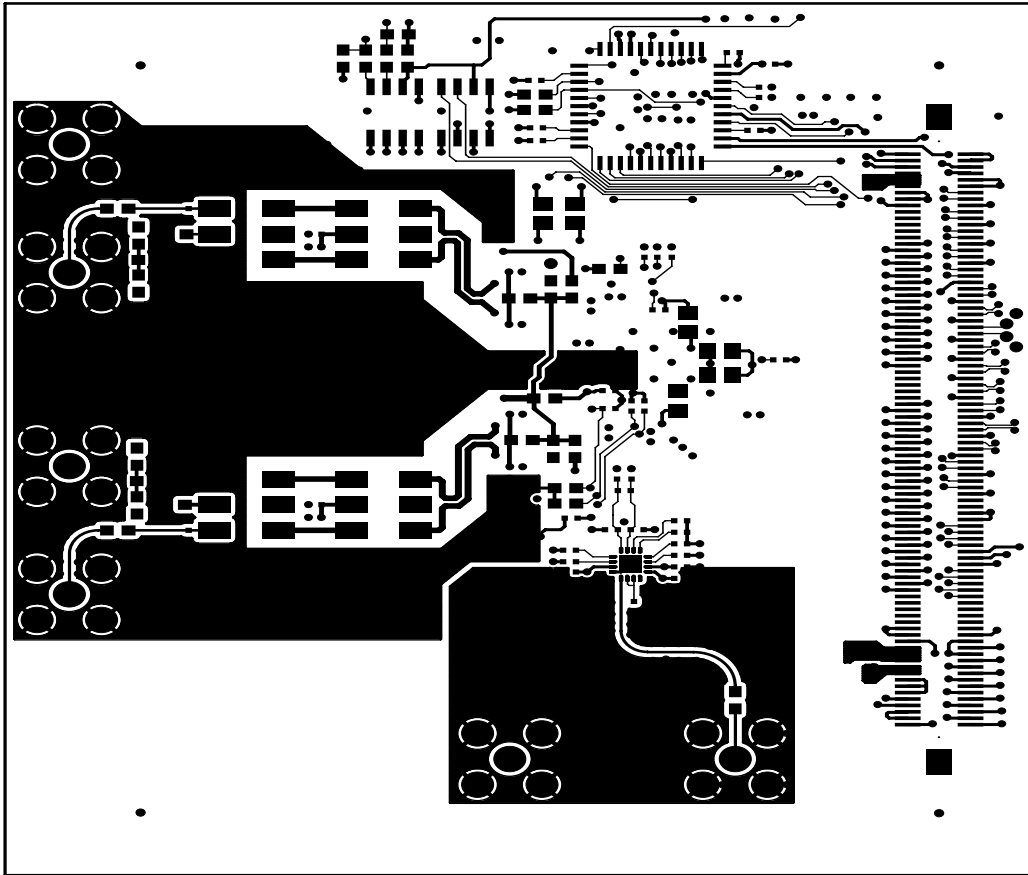

FIGURE 9. SECONDARY SIDE

KDC5612EVAL Layers (Continued)

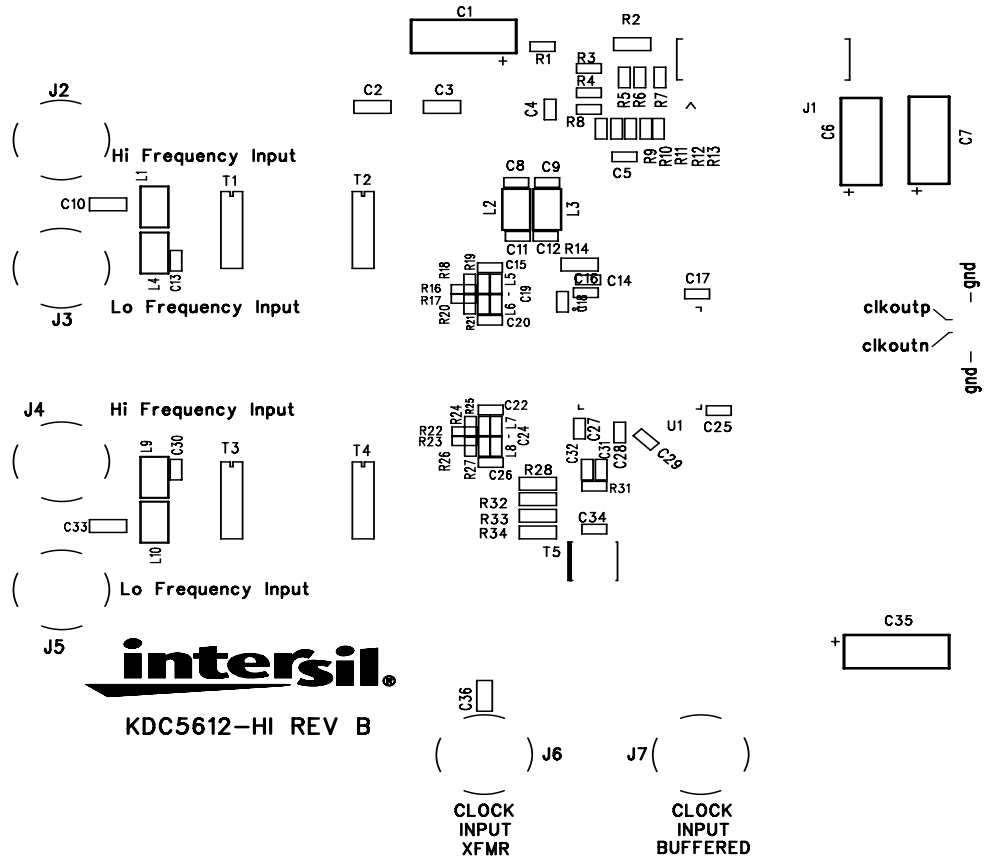

FIGURE 11. LAYER - PRIMARY SIDE SILKSCREEN

Intersil Corporation reserves the right to make changes in circuit design, software and/or specifications at any time without notice. Accordingly, the reader is cautioned to verify that the Application Note or Technical Brief is current before proceeding.

For information regarding Intersil Corporation and its products, see www.intersil.com