

DA9318 High-Efficiency, 10 A, High-Voltage Direct Charger

Current doubler delivering up to 10 A charge current, with efficiency of up to 98 % and providing up to 44 W

DA9318 is optimized to handle high charging currents and at the same time ensure the safety of the battery and the system. It operates together with a main charger, which handles the pre-charge and constant voltage charging duties.

The current doubling is achieved with a high-efficiency capacitive divider that provides an output voltage of $V_{IN}/2$, which allows the use of standard USB Type-C™ cables for charging currents up to 6 A. The peak efficiency of the DA9318 is 98 %. With maximum 8 A output current, the DA9318L variant can provide 35 W of charging power, whereas the DA9318M variant provides 10 A output current and 44 W of charging power.

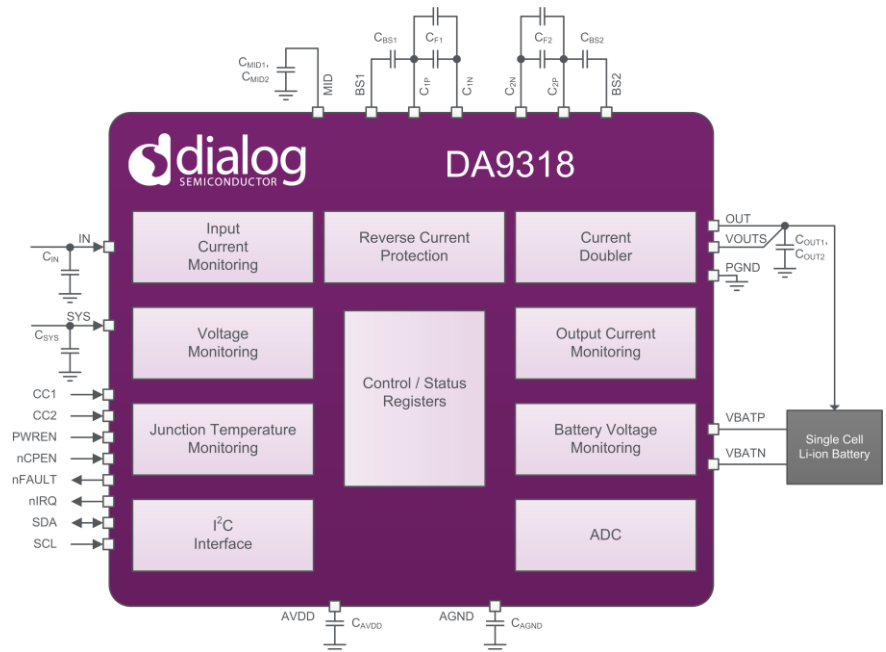

A reverse protection feature blocks current flow in both directions while the device is not operational. Additionally, the battery is protected by DA9318 through six hardware based safety functions for any over- or under-voltage condition. All safety triggered events lead to an automatic shutdown and are reported via interrupt to the system.

DA9318 also features an 8-bit analog-to-digital converter (ADC) for input and output current and voltage, and junction temperature monitoring which ensures safety during direct charging. The programmable watchdog timer can be used for software supervision and for battery overload protection a safety timer is also integrated. An I²C compatible 2-wire interface is provided for the device control.

The DA9318 is available in a small WLCSP 3.62 mm × 3.78 mm package.

Features

- ▶ 8 A output current (DA9318L)
- ▶ 10 A output current (DA9318M)
- ▶ 98 % efficiency at 3 A
- ▶ 5 % current sense accuracy (DA9318L)
- ▶ 10 % current sense accuracy (DA9318M)
- ▶ Reverse and forward current protection in IDLE mode
- ▶ Safe high-voltage direct charging
- ▶ Safety timer and watchdog
- ▶ 8-bit ADC input and output voltage and current, and junction temperature monitoring
- ▶ I²C compatible 2-wire interface
- ▶ Automatic shutdown in fault condition
- ▶ Travel adapter detection
- ▶ No inductor
- ▶ 64-pin WLCSP package 3.62 mm x 3.78 mm

Applications

Direct charging in smartphones and tablets, battery packs, Li-ion battery powered devices.

Typical Characteristics

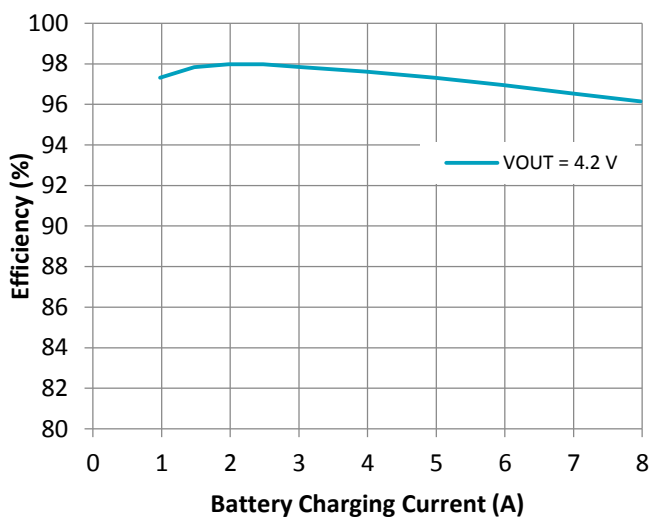

DA9318L Efficiency

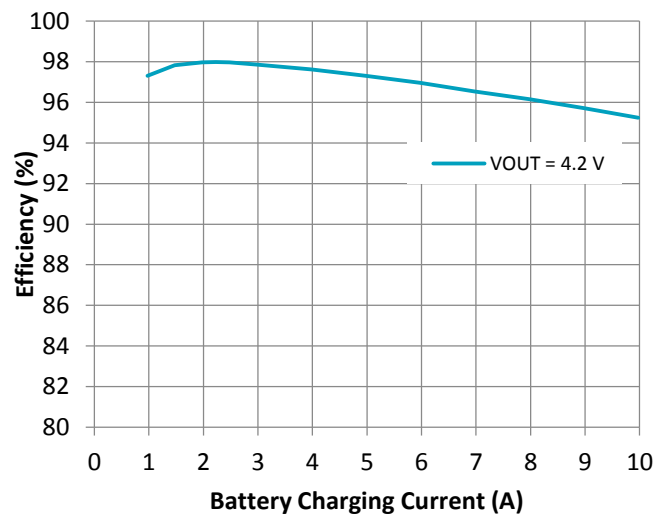

DA9318M Efficiency

Typical Characteristics

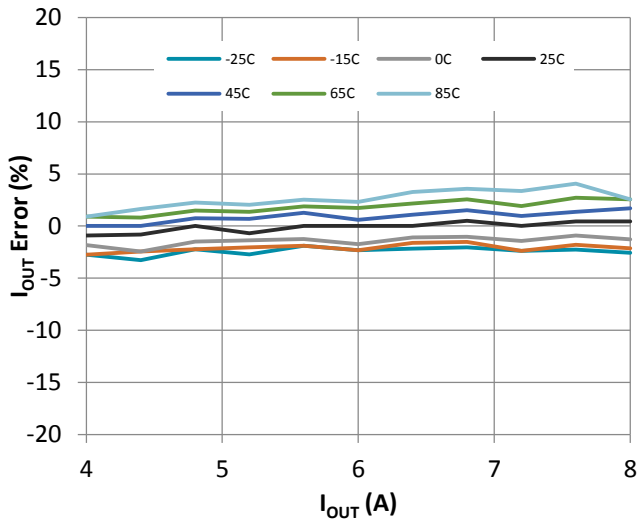

DA9318L I_{OUT} Accuracy Over Temperature

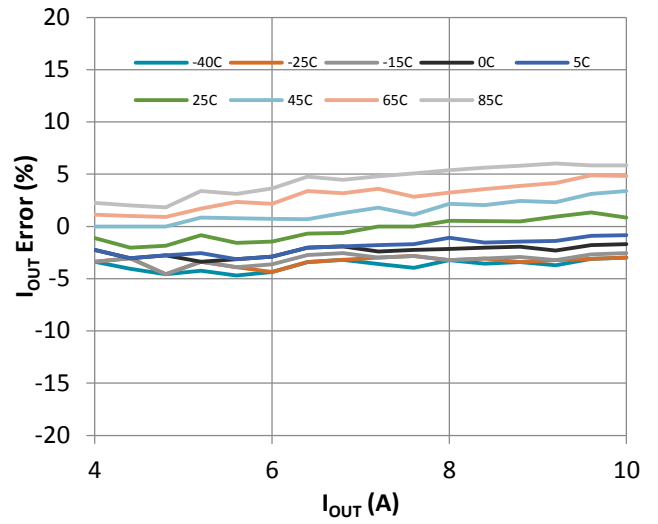

DA9318M I_{OUT} Accuracy Over Temperature

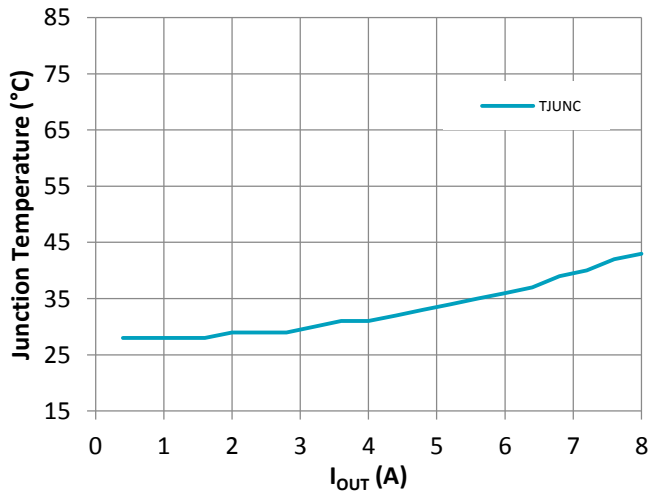

DA9318L Junction Temperature

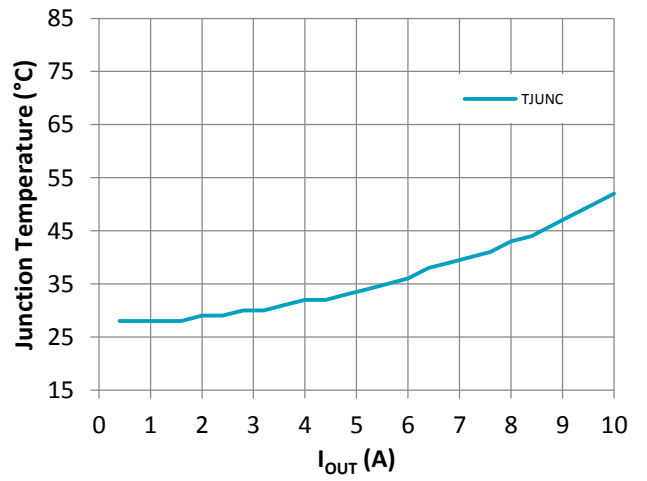

DA9318M Junction Temperature

System Level Block Diagram

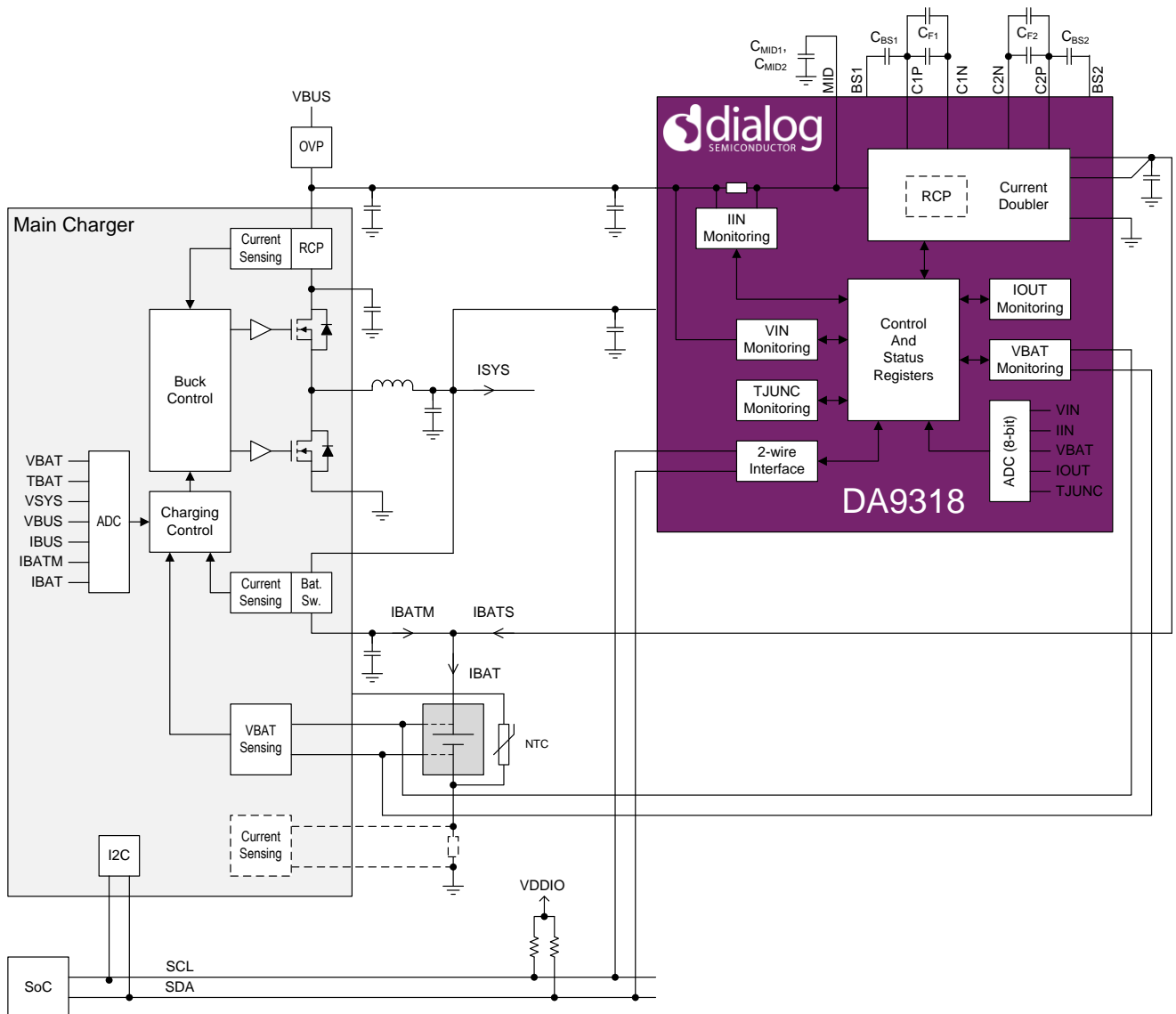

Corporate Headquarters

TOYOSU FORESIA, 3-2-24 Toyosu

Koto-ku, Tokyo 135-0061, Japan

www.renesas.com

Contact Information

For further information on a product, technology, the most up-to-date version of a document, or your nearest sales office, please visit:

<https://www.renesas.com/contact/>

Trademarks

Renesas and the Renesas logo are trademarks of Renesas Electronics Corporation. All trademarks and registered trademarks are the property of their respective owners.