

REVISIONS			
DATE CREATED	REV	DESCRIPTION	AUTHOR
11/02/16	00	INITIAL RELEASE	CK LEE
5/7/19	01	CORRECT LAND PATTERN DIMENSION	CK LEE

NOTE: REFER TO AGILE FOR OFFICIAL RELEASE DATE

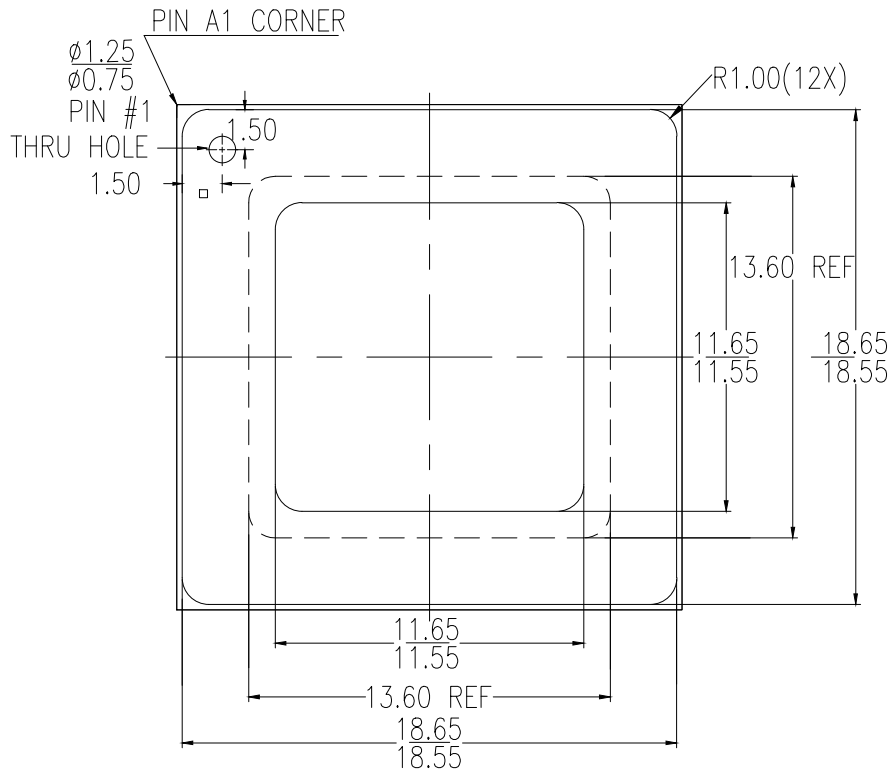

TOP VIEW

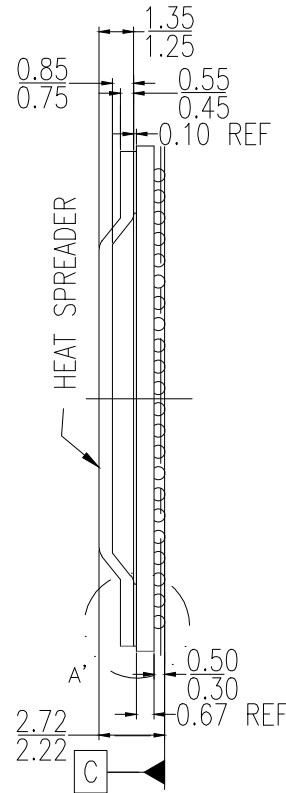

SIDE VIEW

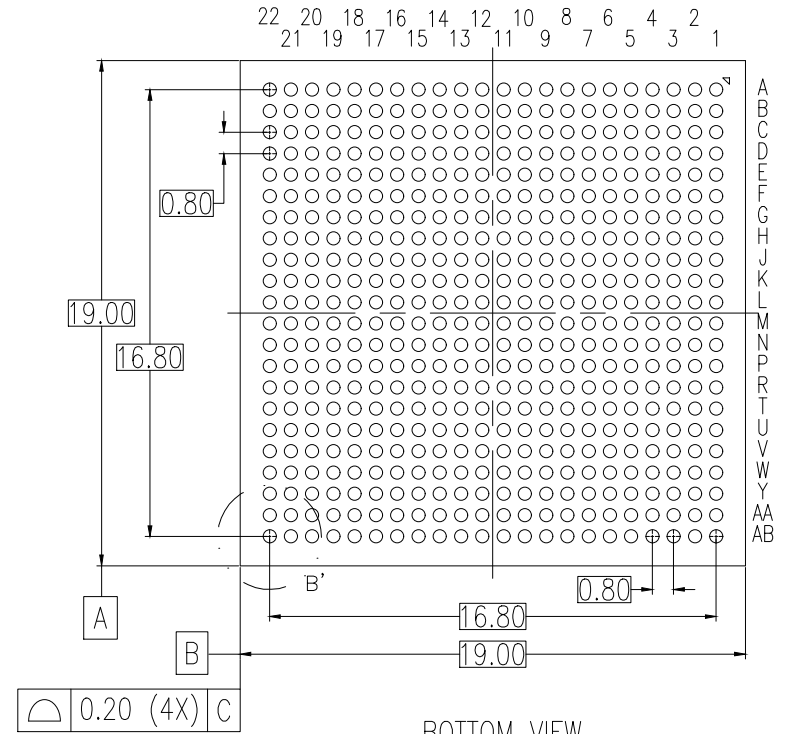

BOTTOM VIEW

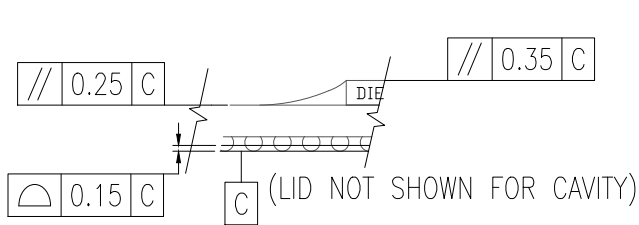

DETAIL A'

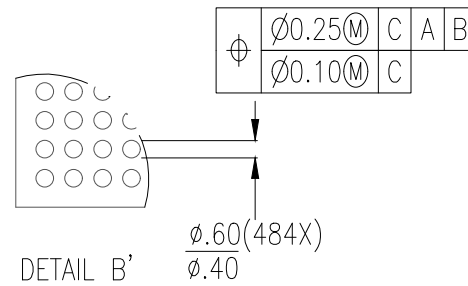

DETAIL B'

NOTES:

1. ALL DIMENSIONS AND TOLERANCES ARE PER ASME Y14.5-1994.
2. ALL DIMENSIONS ARE IN MILLIMETERS.

TOLERANCES UNLESS SPECIFIED		 www.IDT.com	6024 SILVER CREEK VALLEY ROAD, SAN JOSE, CA 95138 PHONE: (408) 284-8200 FAX: (408) 284-3572
DECIMAL	ANGULAR		
XX±	±	TITLE ALG484 Package Outline Drawing 19.0 x 19.0 x 2.47 mm Body, 0.80mm Pitch 6 Layers FCBGA	
XXX±		SIZE	REV
XXXX±		C	01
DO NOT SCALE DRAWING			SHEET 1 OF 2

		REVISIONS	
DATE CREATED	REV	DESCRIPTION	AUTHOR
11/02/16	00	INITIAL RELEASE	CK LEE
5/7/19	01	CORRECT LAND PATTERN DIMENSION	CK LEE

NOTE: REFER TO AGILE FOR OFFICIAL RELEASE DATE

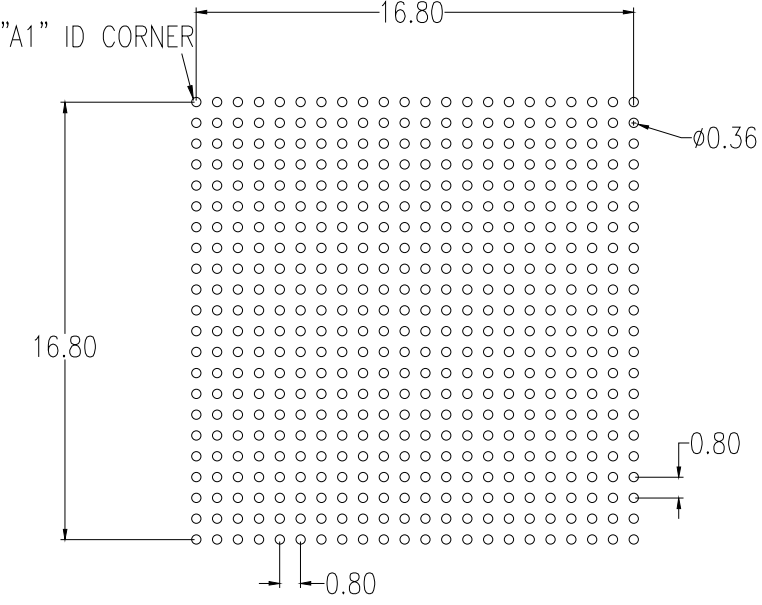

RECOMMENDED LAND PATTERN DIMENSION

NOTES:

1. ALL DIMENSIONS AND TOLERANCES ARE PER ASME Y14.5-1994.
2. ALL DIMENSIONS ARE IN MILLIMETERS.
3. LAND PATTERN RECOMMENDATION PER IPC-7315B GENERIC REQUIREMENT FOR SURFACE MOUNT DESIGN AND LAND PATTERN.

TOLERANCES UNLESS SPECIFIED DECIMAL ANGULAR XX± ± XXX± XXXX±	 www.IDT.com	6024 SILVER CREEK VALLEY ROAD, SAN JOSE, CA 95138 PHONE: (408) 284-8200 FAX: (408) 284-3572	
		TITLE ALC484 Package Outline Drawing 19.0 x 19.0 x 2.47 mm Body, 0.80mm Pitch 6 Layers FCBCA	
SIZE C	DRAWING No. PSC-4679	REV 01	
DO NOT SCALE DRAWING		SHEET 2 OF 2	