

REVISIONS			
REV	DESCRIPTION	DATE	APPROVED
00	INITIAL RELEASE	11/03/11	CK
01	CHANGE PACKAGE THICKNESS DIM	08/23/12	CK
02	ADD NOMINAL AND MAXIMUM VALUE FOR b1 COMBINE POD & LAND PATTERN	10/31/13	CK
03	REMOVE NUMBER OF LAYER IN TITLE BLOCK	10/12/15	CK

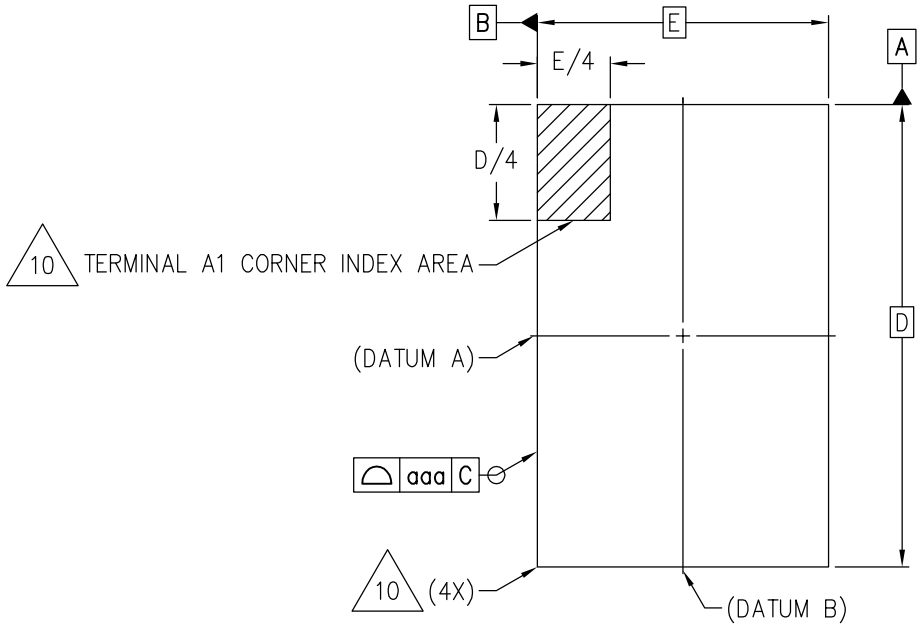

TOP VIEW

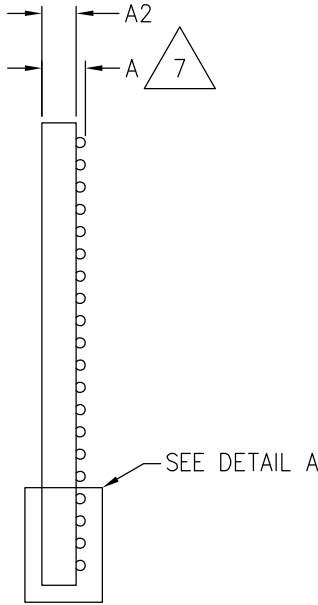

SIDE VIEW

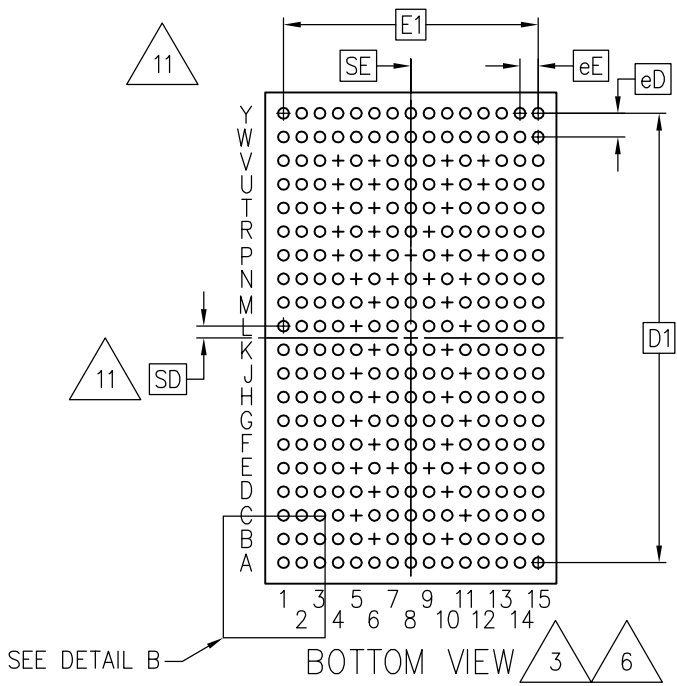

BOTTOM VIEW

TOLERANCES UNLESS SPECIFIED		 6024 Silver Creek Valley Rd San Jose, CA 95138 PHONE: (408) 284-8200 www.IDT.com FAX: (408) 284-2775	TITLE AT/ATC253 8.00 X 13.50 mm BODY DUAL PITCH (0.50MM X 0.65MM) FCCSP
DECIMAL	ANGULAR		
XX±.1	±		
XXX±.05			
XXXX±.030			
APPROVALS	DATE	SIZE	DRAWING No.
DRAWN <i>CXC</i>	11/03/11	C	PSC-4395
CHECKED			REV 03
DO NOT SCALE DRAWING			SHEET 1 OF 6

REVISIONS			
REV	DESCRIPTION	DATE	APPROVED
00	INITIAL RELEASE	11/03/11	CK
01	CHANGE PACKAGE THICKNESS DIM	08/23/12	CK
02	ADD NOMINAL AND MAXIMUM VALUE FOR b1 COMBINE PAD & LAND PATTERN	10/31/13	CK
03	REMOVE NUMBER OF LAYER IN TITLE BLOCK	10/12/15	CK

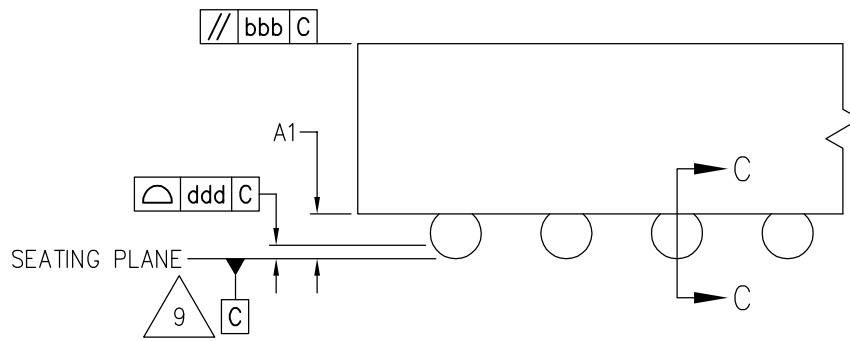

DETAIL A
(ROTATED 90° CW)

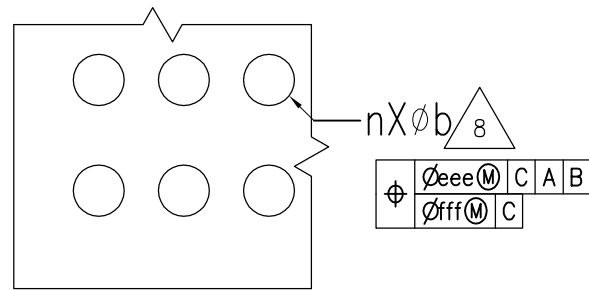

DETAIL B

TYPE 1 – SMD
(SOLDER MASK DEFINED)

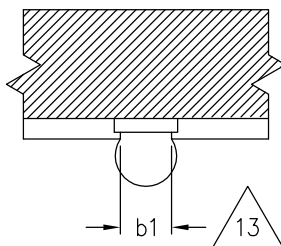

TYPE 2 – NSMD
(NON SOLDER MASK DEFINED)

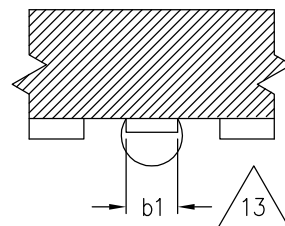

SECTION C-C

TOLERANCES
UNLESS SPECIFIED
DECIMAL ANGULAR
XX±.1 ±
XXX±.05
XXXX±.030

IDT™ 6024 Silver Creek Valley Rd
San Jose, CA 95138
PHONE: (408) 284-8200
www.IDT.com FAX: (408) 284-2775

APPROVALS DATE
DRAWN *CK* 11/03/11
CHECKED

TITLE AT/ATG253 8.00 X 13.50 mm BODY
DUAL PITCH (0.50MM X 0.65MM)
FCCSP

SIZE
C

DRAWING No. PSC-4395
REV 03

DO NOT SCALE DRAWING SHEET 2 OF 6

REVISIONS			
REV	DESCRIPTION	DATE	APPROVED
00	INITIAL RELEASE	11/03/11	CK
01	CHANGE PACKAGE THICKNESS DIM	08/23/12	CK
02	ADD NOMINAL AND MAXIMUM VALUE FOR b1 COMBINE POD & LAND PATTERN	10/31/13	CK
03	REMOVE NUMBER OF LAYER IN TITLE BLOCK	10/12/15	CK

TABLE 1				
COMMON DIMENSIONS				
SYMBOL	L: LOW PROFILE			NOTES
	MIN	NOM	MAX	
A	1.24	1.32	1.40	7
A1	0.19	0.24	0.29	7
A2	1.02	1.08	1.15	
b	0.25	0.30	0.35	
b1	TYPE1	0.225	0.275	0.325
	TYPE2	0.20	-	-
eD	0.65 BSC			4
eE	0.50 BSC			4
NOTES	1, 2			
REF	11-856			
ISSUE	A			

TABLE 2		
RECTANGULAR VARIATIONS		
VARIATION ► SYMBOL ▼	AA	NOTES
D BSC	13.50	2
E BSC	8.00	2
D1 BSC	12.35	2
E1 BSC	7.00	2
MD	20	
ME	15	
SD BSC	0.325	2
SE BSC	0.00	2
n	253	12
N	300	5
FOOTPRINT	1	12
NOTES	1	
REF	11-856	
ISSUE	A	

TABLE 3	
TOLERANCE OF FORM AND POSITION	
SYMBOL	VALUE
aaa	0.15
bbb	0.20
ddd	0.08
eee	0.15
fff	0.05
NOTES	1, 2
REF	11-856
ISSUE	A

TOLERANCES UNLESS SPECIFIED		 6024 Silver Creek Valley Rd San Jose, CA 95138 PHONE: (408) 284-8200 www.IDT.com FAX: (408) 284-2775
DECIMAL	ANGULAR	
XX±.1	±	
XXX±.05		
XXXX±.030		
APPROVALS	DATE	TITLE
DRAWN <i>CK</i>	11/03/11	AT/ATG253 8.00 X 13.50 mm BODY DUAL PITCH (0.50MM X 0.65MM) FCCSP
CHECKED		
		SIZE
		DRAWING No.
		C
		PSC-4395
		REV
		03
DO NOT SCALE DRAWING		SHEET 3 OF 6

REVISIONS			
REV	DESCRIPTION	DATE	APPROVED
00	INITIAL RELEASE	11/03/11	CK
01	CHANGE PACKAGE THICKNESS DIM	08/23/12	CK
02	ADD NOMINAL AND MAXIMUM VALUE FOR b1 COMBINE POD & LAND PATTERN	10/31/13	CK
03	REMOVE NUMBER OF LAYER IN TITLE BLOCK	10/12/15	CK

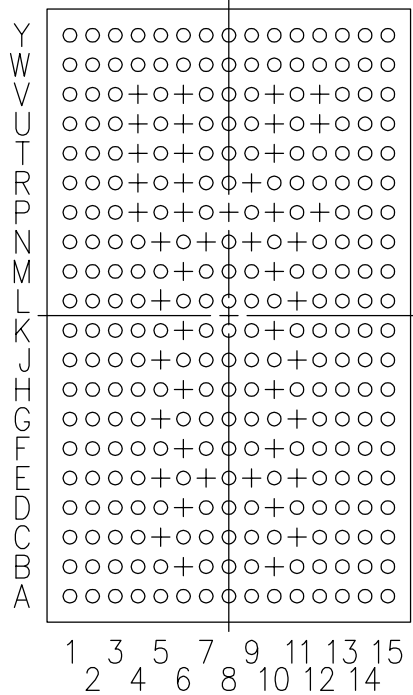

FOOTPRINT 1 

+ = DEPOPULATED BALL POSITIONS

TOLERANCES UNLESS SPECIFIED		 6024 Silver Creek Valley Rd San Jose, CA 95138 PHONE: (408) 284-8200 www.IDT.com FAX: (408) 284-2775	
DECIMAL	ANGULAR		
XX±.1	±		
XXX±.05			
XXXX±.030			
APPROVALS	DATE	TITLE	
DRAWN <i>CK</i>	11/03/11	AT/ATG253 8.00 X 13.50 mm BODY DUAL PITCH (0.50MM X 0.65MM) FCCSP	
CHECKED		SIZE	DRAWING No.
		C	PSC-4395
			REV
			03
DO NOT SCALE DRAWING			SHEET 4 OF 6

NOTES:

1. DIMENSIONING AND TOLERANCING PER ASME Y14.5M-1994.
2. ALL DIMENSIONS ARE IN MILLIMETERS.
- 3 SOLDER BALL POSITION DESIGNATOR PER JEP95, SECTION 3, SPP-020.
4. 'eD' AND 'eE' REPRESENT THE SOLDER BALL GRID PITCH CORRESPONDING TO THE D AND E DIRECTIONS RESPECTIVELY.
5. N REPRESENTS THE MAXIMUM NUMBER OF SOLDER BALLS FOR MATRIX SIZES MD, ME.
- 6 A FULLY POPULATED 16 X 20 MATRIX SIZE IS SHOWN FOR ILLUSTRATION ONLY.
- 7 DIMENSION "A" INCLUDES STANDOFF HEIGHT "A1", PACKAGE BODY THICKNESS AND LID HEIGHT, BUT DOES NOT INCLUDE ATTACHED FEATURES, e.g. EXTERNAL HEAT SINK. AN INTEGRAL HEAT SLUG IS NOT CONSIDERED AN ATTACHED FEATURE.
- 8 DIMENSION "b" IS MEASURED AT THE MAXIMUM SOLDER BALL DIAMETER PARALLEL TO PRIMARY DATUM C.
- 9 PRIMARY DATUM C (SEATING PLANE) IS DEFINED BY THE PLANE ESTABLISHED BY THE CONTACT POINTS OF THREE OR MORE SOLDER BALLS THAT SUPPORT THE DEVICE WHEN IT IS PLACED ON TOP OF A PLANAR SURFACE.
- 10 THE CORNER A1 MUST BE IDENTIFIED ON BOTH THE BOTTOM AND TOP SIDES OF THE PACKAGE, THE IDENTIFICATION FEATURE CAN BE MADE USING INK OR METALIZED MARKINGS, IDENTATIONS, OR OTHER FEATURES. THE EXACT SHAPE OF EACH CORNER IS OPTIONAL.
- 11 DIMENSIONS 'SD' AND 'SE' ARE MEASURED WITH RESPECT TO DATUM A AND DATUM B AND DEFINE THE POSITION OF THE CENTER SOLDER BALL IN THE OUTER ROW. WHEN THERE IS AN ODD NUMBER OF SOLDER BALLS IN THE OUTER ROW 'SD' OR 'SE' = 0 WHEN THERE IS AN EVEN NUMBER OF SOLDER BALLS IN THE OUTER ROW, 'SD' = eD/2 AND 'SE' = eE/2.
- 12 SOLDER BALL DEPOPULATION IS ALLOWED. DEPOPULATION IS THE OMISSION OF SOLDER BALLS FROM A FULL MATRIX (MD, ME).
- 13 SOLDERABLE SURFACE MAY BE DEFINED BY AN OPENING IN THE SOLDER RESIST LAYER (TYPE 1) OR BY THE SIZE OF A METALIZED PAD (TYPE 2). IT MAY BE ELLIPTICAL PROVIDED THE RATIO OF MAJOR TO MINOR AXES IS NO GREATER THAN 2/1 AND THE SURFACE AREA IS NO LESS THAN THE MINIMUM FOR A CIRCULAR PAD. FOR TYPE 2 DESIGNS, EXPOSED COPPER TRACES ARE PERMITTED OUTSIDE THE b1 PAD AREA.

REVISIONS			
REV	DESCRIPTION	DATE	APPROVED
00	INITIAL RELEASE	11/03/11	CK
01	CHANGE PACKAGE THICKNESS DIM	08/23/12	CK
02	ADD NOMINAL AND MAXIMUM VALUE FOR b1 COMBINE PAD & LAND PATTERN	10/31/13	CK
03	REMOVE NUMBER OF LAYER IN TITLE BLOCK	10/12/15	CK

TOLERANCES UNLESS SPECIFIED		 6024 Silver Creek Valley Rd San Jose, CA 95138 PHONE: (408) 284-8200 FAX: (408) 284-2775 www.IDT.com	
DECIMAL	ANGULAR		
XX±.1	±		
XXX±.05			
XXXX±.030			
APPROVALS	DATE	TITLE AT/ATG253 8.00 X 13.50 mm BODY	
DRAWN <i>CK</i>	11/03/11	DUAL PITCH (0.50MM X 0.65MM)	
CHECKED		FCCSP	
	SIZE	DRAWING No.	REV
	C	PSC-4395	03
DO NOT SCALE DRAWING			SHEET 5 OF 6

REVISIONS			
REV	DESCRIPTION	DATE	APPROVED
00	INITIAL RELEASE	11/03/11	CK
01	CHANGE PACKAGE THICKNESS DIM	08/23/12	CK
02	ADD NOMINAL AND MAXIMUM VALUE FOR b1 COMBINE POD & LAND PATTERN	10/31/13	CK
03	REMOVE NUMBER OF LAYER IN TITLE BLOCK	10/12/15	CK

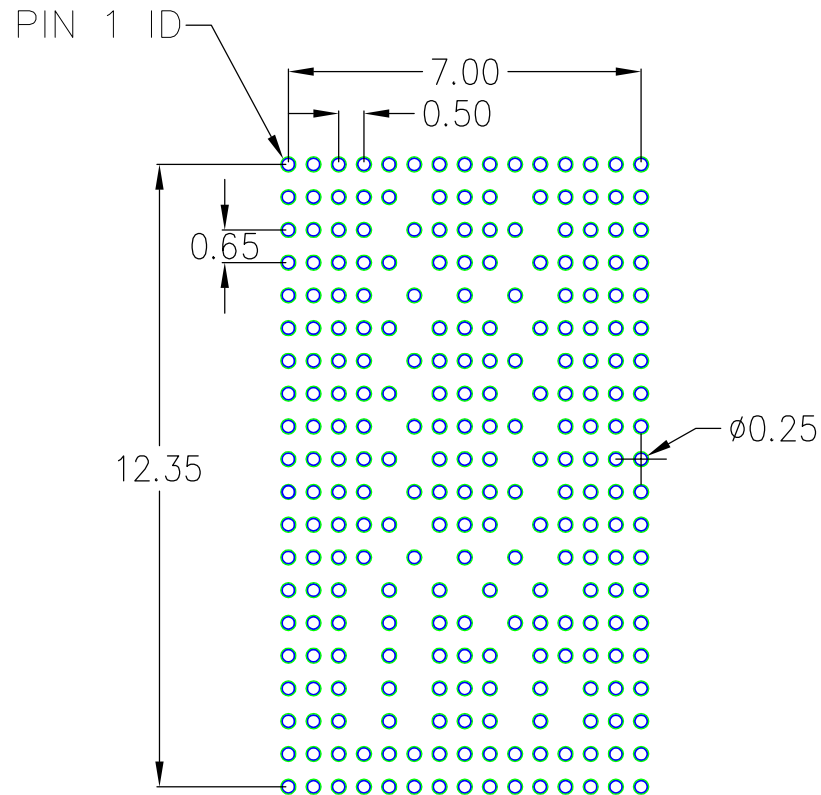

RECOMMENDED LAND PATTERN DIMENSION

NOTES:

1. ALL DIMENSION ARE IN mm. ANGLES IN DEGREES.
2. TOP DOWN VIEW. AS VIEWED ON PCB.
3. COMPONENT OUTLINE SHOW FOR REFERENCE IN GREEN.
4. LAND PATTERN IN BLUE. NSMD PATTERN ASSUMED.
5. LAND PATTERN RECOMMENDATION PER IPC-7351B GENERIC REQUIREMENT FOR SURFACE MOUNT DESIGN AND LAND PATTERN.

TOLERANCES UNLESS SPECIFIED		 6024 Silver Creek Valley Rd San Jose, CA 95138 PHONE: (408) 284-8200 www.IDT.com FAX: (408) 284-2775	
DECIMAL	ANGULAR		
XX±.1	±		
XXX±.05			
XXXX±.030			
APPROVALS	DATE	TITLE AT/ATG253 8.00 X 13.50 mm BODY	
DRAWN <i>CK</i>	11/03/11	DUAL PITCH (0.50MM X 0.65MM)	
CHECKED		FCCSP	
		SIZE	REV
		C	03
		DRAWING No.	
		PSC-4395	
DO NOT SCALE DRAWING			SHEET 6 OF 6