

1521-PIN PLASTIC BGA (FLIP CHIP TYPE) (40x40)

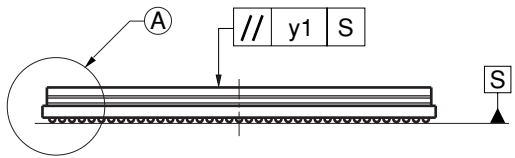

DETAIL OF (A) PART

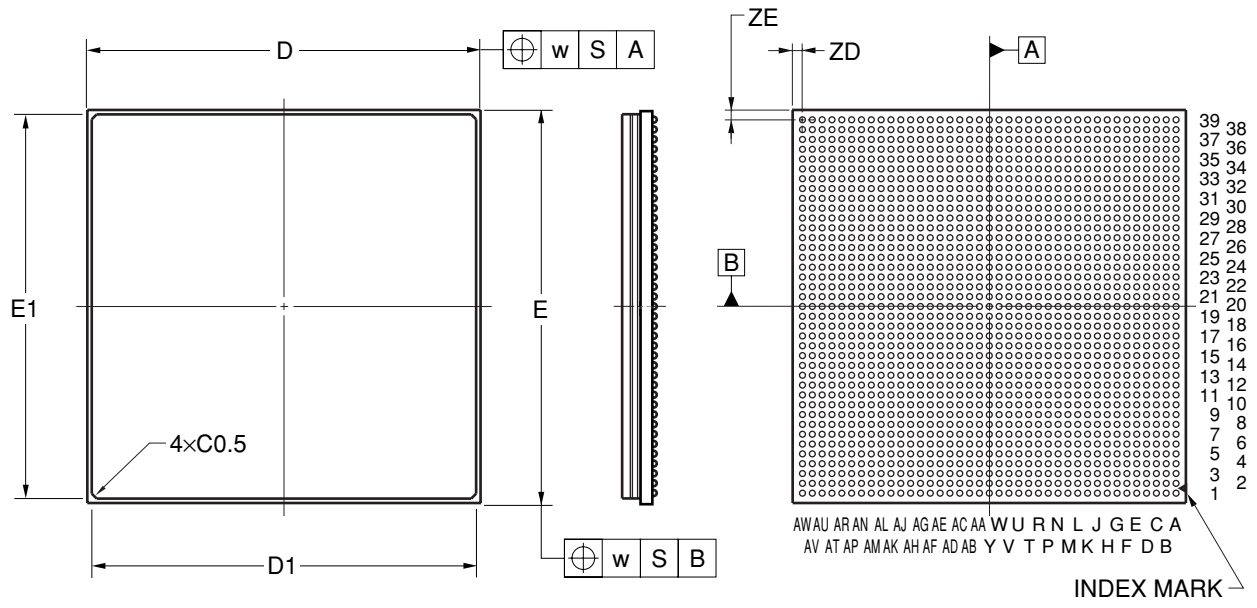
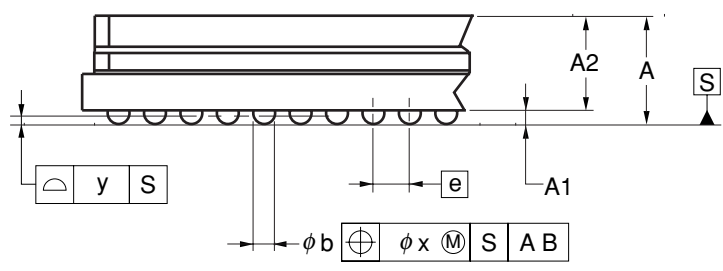

(UNIT:mm)

ITEM	DIMENSIONS
D	40.00±0.10
D1	39.10±0.05
E	40.00±0.10
E1	39.10±0.05
w	0.30
e	1.00
A	3.57±0.40
A1	0.45±0.10
A2	3.12
b	0.65±0.10
x	0.10
y	0.15
y1	0.35
ZD	1.00
ZE	1.00

P1521F5-100-UA2