

## 48-PIN PLASTIC FBGA (8x6)

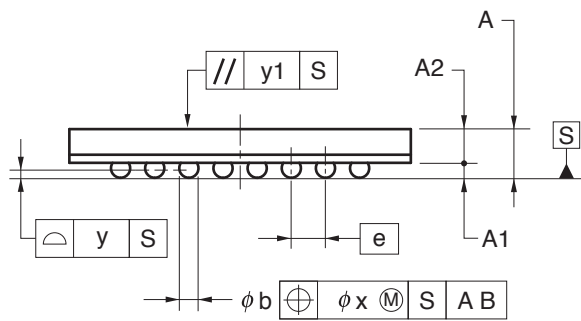
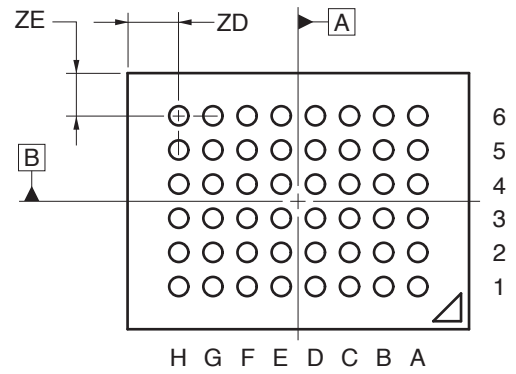
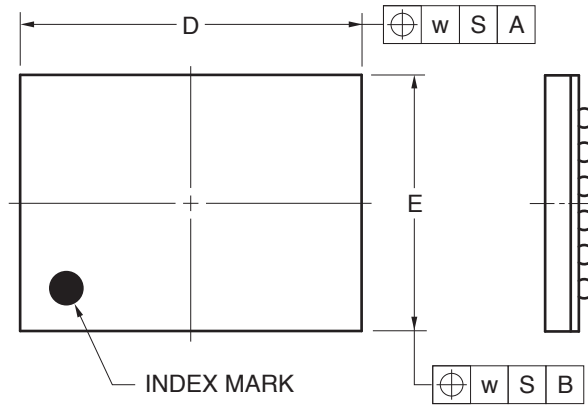

(UNIT:mm)

ITEM	DIMENSIONS
D	8.00±0.10
E	6.00±0.10
w	0.20
A	1.14±0.10
A1	0.35±0.05
A2	0.79
e	0.80
b	0.45±0.05
x	0.08
y	0.10
y1	0.20
ZD	1.20
ZE	1.00

P48F1-80-BC1-1