

85-PIN TAPE FBGA (6x6)

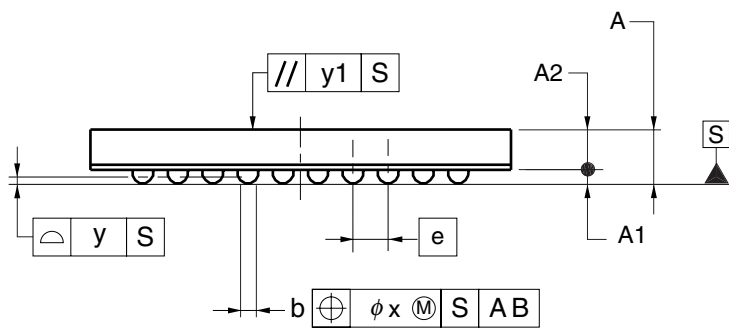
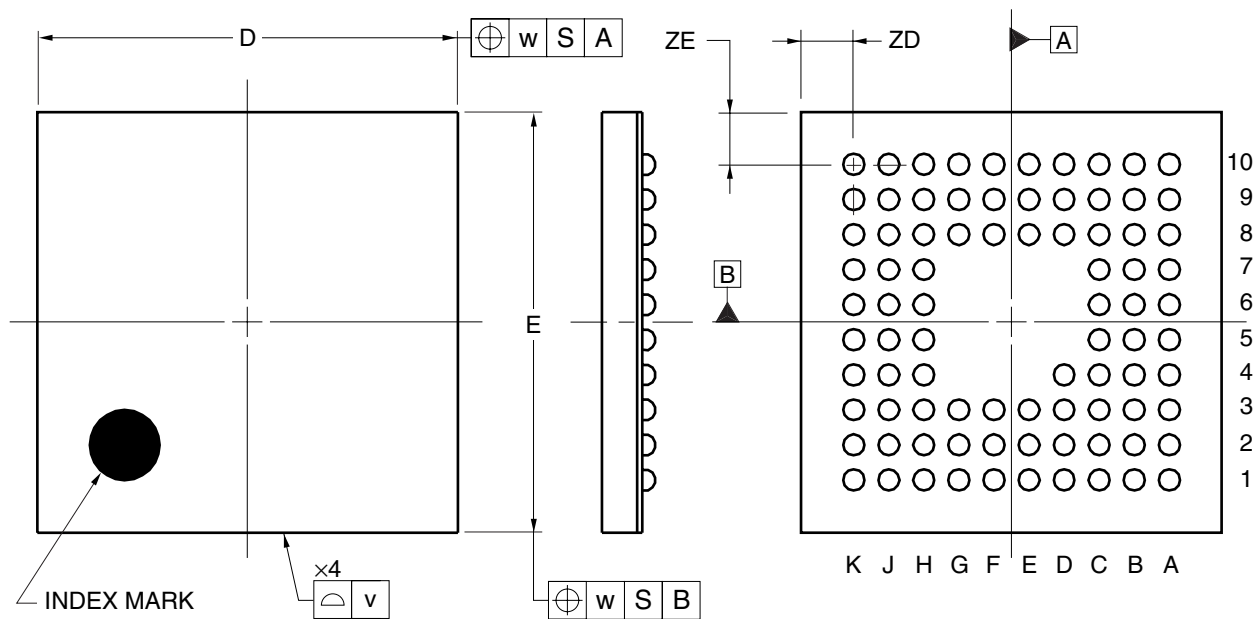

(UNIT:mm)

ITEM	DIMENSIONS
D	6.00±0.10
E	6.00±0.10
v	0.15
w	0.20
e	0.50
A	0.83±0.10
A1	0.18±0.05
A2	0.65
b	0.32±0.05
x	0.05
y	0.08
y1	0.20
ZD	0.75
ZE	0.75

P85F9-50-BA3