

YMCRPRX62T: RX62T Motor Control Evaluation Kit Quick Start Guide

1. Introduction

The goal of this Quick Start Guide is to get the RX62T motor kit quickly up and running. The RX62T microcontroller is pre-programmed to run the “Three-shunt Sensorless Vector Control with External Amplifier” algorithm. The user needs to connect the motor and the power supply to get started.

Caution : Do not connect power to the board until all instructions are followed.

The kit contains the following items:

- RX62T Motor Control Board
- BLDC Motor with a 3-way connector and encoder cable
- 24V DC Power Supply
- E1 Debugger
- Mini USB cable
- Installation CD-ROM (reference: D011025_25) including product documentation
- Printed Quick Start Guide (reference: D011033_11, this document)

2. Board layout and connections

Figure 1 shows the board with the motor connected to **J8** and the power supply to **J3**. There are four push-buttons, a thumb-wheel potentiometer, a graphic LCD and a few simple steps to quickly operate the motor out of the box.



Figure 1 Board Layout

YMCRPRX62T: RX62T Motor Control Evaluation Kit Quick Start Guide

3. Board operation

Before supplying power to the board, verify that the jumper settings match the setting shown in Figure 2.

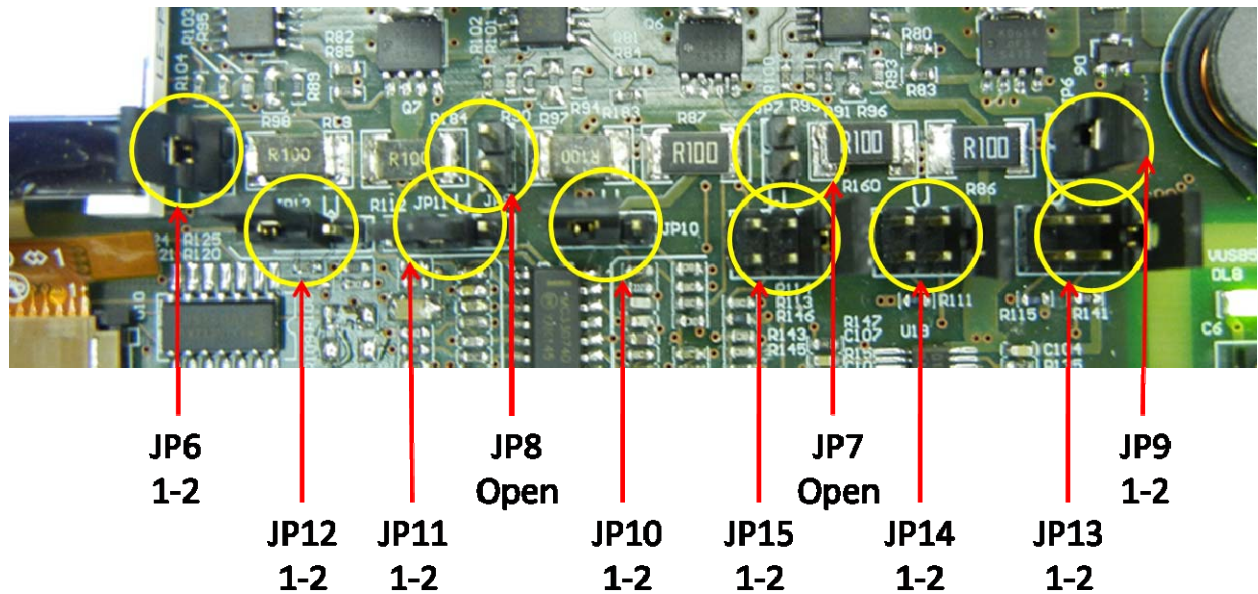

Figure 2 Default Jumper Settings

The default algorithm loaded into the RX62T flash memory is the “Three-shunt Sensorless Vector Control with External Amplifier.” The board can be operated in Standalone mode or in PC-GUI mode. The Standalone mode is discussed next, followed by the PC-GUI mode.

YMCRPRX62T: RX62T Motor Control Evaluation Kit Quick Start Guide

4. Standalone mode

After verifying that the jumpers are set correctly as shown in Figure 2, please proceed with the following steps:

1. Connect the motor to **J8**
2. Connect the power supply to **J3** and observe the following:
 - LEDs DL5 and DL9 should be 'ON' indicating the presence of 5V and 12V supply
 - The LCD should display the Renesas logo and board information
3. Press and hold P4 "MODE" while pressing and releasing "RESET" button P6.
 - The LCD will display the logo screen again and after two seconds will switch to the first operating page showing: "REF_RPM", "MEC_RPM", "EL_FREQ" and "DC_BUS_V" as shown in Figure 3.

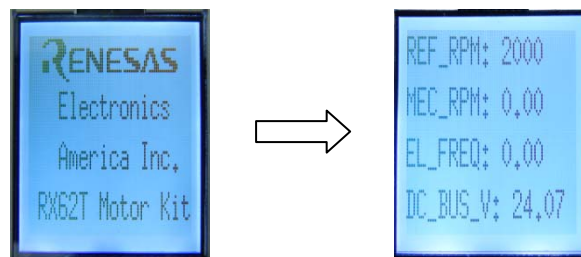

Figure 3 LCD Screen after Step 3

4. Set reference RPM using the thumbwheel potentiometer to 2000 RPM
 - Confirm that the reference REF_RPM value changes on LCD screen
5. Press "START/STOP" once
 - Confirm that the motor is turning and the MEC_RPM indicates the correct speed on LCD screen
6. Press "REVERSE" button
 - Confirm that the motor stops and restart in the opposite direction
 - Observe that the REF_RPM and MEC_RPM become negative on LCD screen
7. Press "FORWARD" button and observe the direction change again.
8. Press the "MODE" button to scroll the LCD through several display pages.
9. Press "START/STOP" again to stop the motor

This concludes the standalone mode operation.

5. PC GUI mode

This mode requires the user to install the PC GUI program on the PC and connect the board using the supplied Mini-USB cable.

1. Insert the CD into your computer's CD-ROM drive.
 - The CD should automatically run the installation program.
 - If the installer doesn't start, browse to the YMCRPRX62T directory from the CD root folder and double click on "setup.exe".
2. Press "Install Motor Control Demo" button as shown in Figure 4
 - This will install the software on your hard-disk



Figure 4 GUI Installation Screen after Step 2

3. Connect the board to the PC using the USB cable
 - LED DL8 turns "ON" indicating proper USB bus power
 - The PC will recognize the new hardware and will launch the driver installation screen
4. You may see a screen as shown in Figure 5. Select "**No, not this time**" and press "Next."

YMCRPRX62T: RX62T Motor Control Evaluation Kit Quick Start Guide

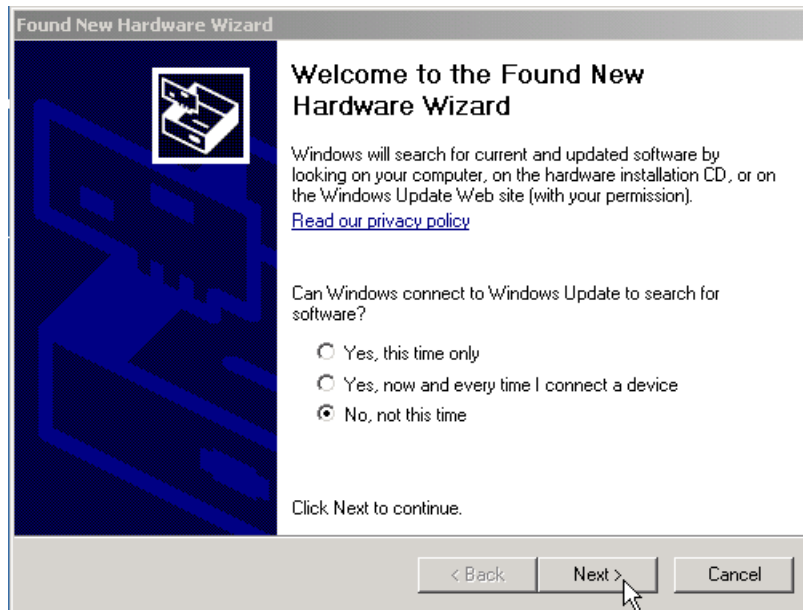

Figure 5 GUI Installation Step 4

6. Select “Install the software automatically (Recommended)” and press “Next”

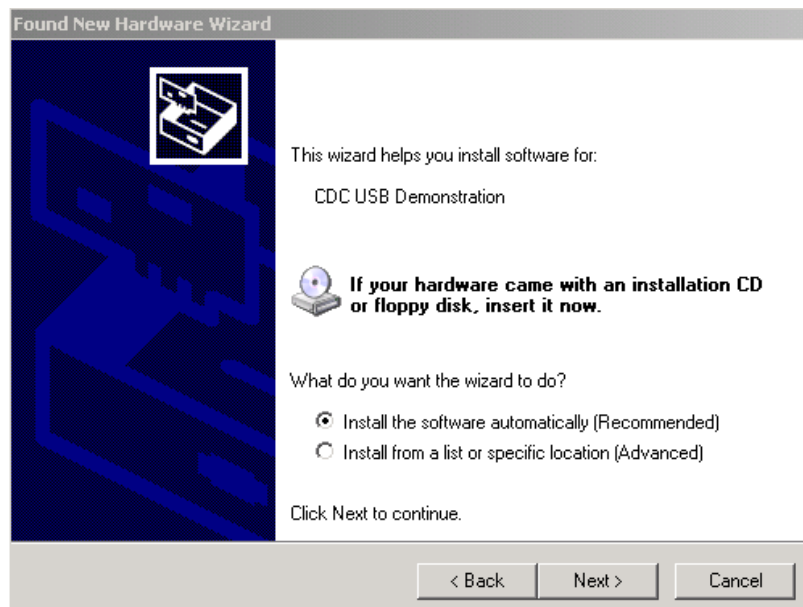

Figure 6 GUI Installation Step 5

YMCRPRX62T: RX62T Motor Control Evaluation Kit Quick Start Guide



Figure 7 GUI Installation Step 6

7. Before the end of the installation you will see the window shown in Figure 7. Press “Continue Anyway” button to finish the USB driver installation.
8. To complete the driver installation press “Finish” button

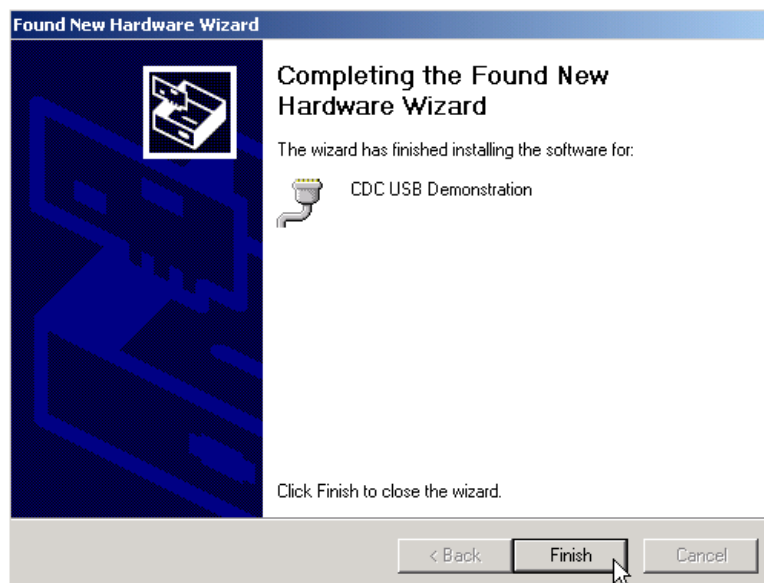

Figure 8 GUI Installation Step 7

- After this the board is ready to be operated from the PC GUI.

YMCRPRX62T: RX62T Motor Control Evaluation Kit Quick Start Guide

9. Start the GUI program by double clicking on the motor control demo icon or, by launching the application from the Start / All Programs menu



- The GUI program screen will launch and display as shown in Figure 9:

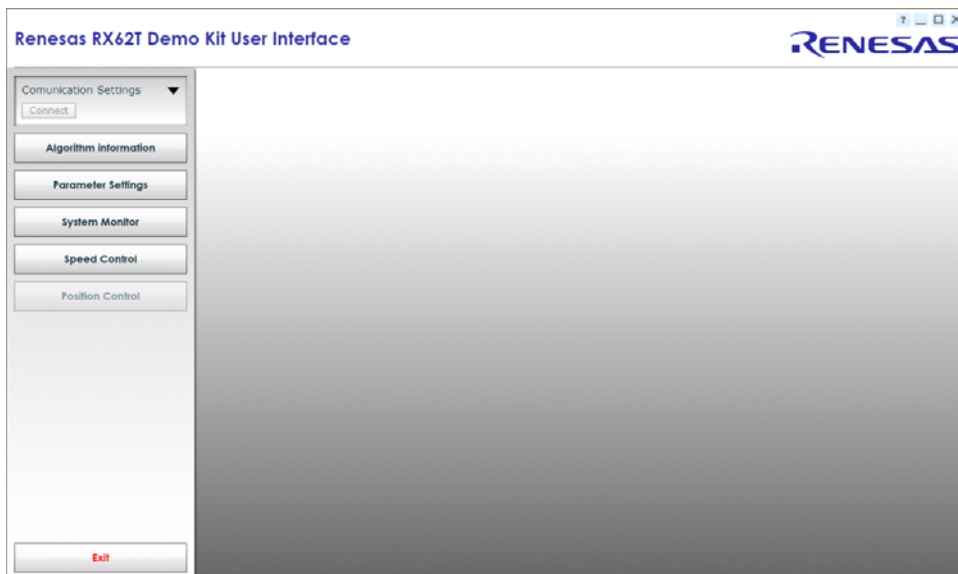

Figure 9 PC-GUI

10. Click "Communication Settings" tab, select "Auto detect" and click "Connect" button
 - The "Communication Settings" area will change colour and "Connect" button will change to "Disconnect" as shown in Figure 10.

YMCRPRX62T: RX62T Motor Control Evaluation Kit Quick Start Guide

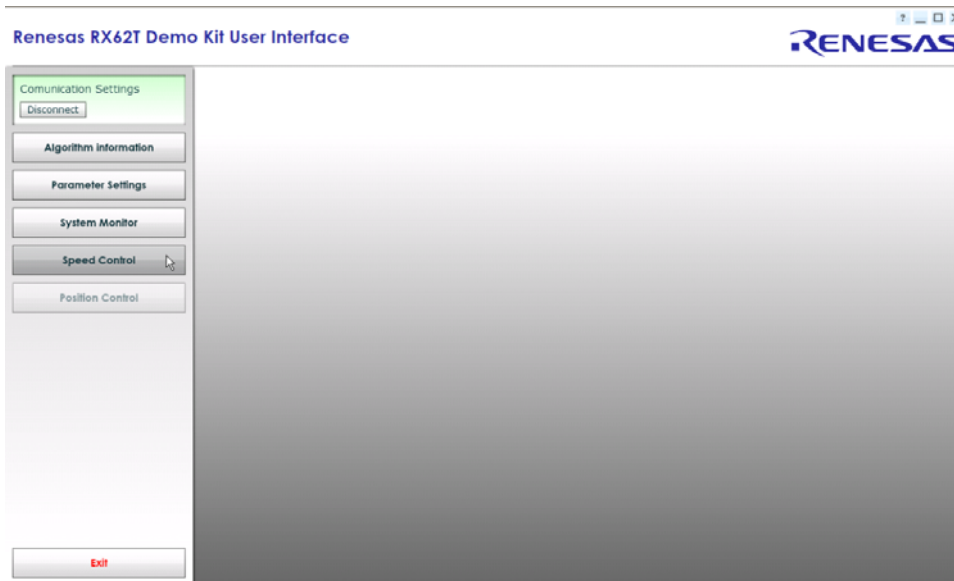

Figure 10 PC-GUI Step 9

11. Press “Speed Control” button to bring up the control window:

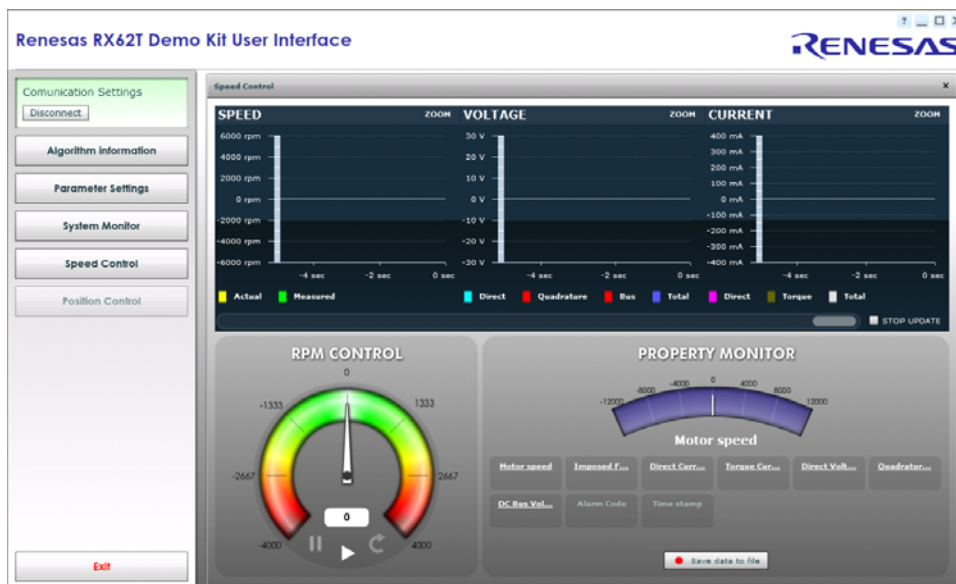

Figure 11 PC-GUI Step 10

YMCRPRX62T: RX62T Motor Control Evaluation Kit Quick Start Guide

12. Drag the RPM control needle to the right to set the reference RPM to around 2000
 - The motor will start and the motor speed, voltage and current will be displayed.



Figure 12 PC-GUI Step 11

13. Drag the RPM control needle to the left to change direction
14. Bring the needle to the middle or press the stop button to stop the motor
15. Press "Disconnect" button and close the application to exit.

This concludes the Quick Start Guide. Further reading and product support information follows.



YMCRPRX62T: RX62T Motor Control Evaluation Kit Quick Start Guide

Further reading

To further explore the features and capabilities of this kit please consult the following documents, they are located on the CD and can be reached using the Manual navigator (or Explore the CD):

Rx62T Motor Kit Quick Start Guide – Document: D011033_11_V0100 (this document)

Three Shunt Sensor-less Vector Control of PMSM Motors – Document: R01AN0903EU

Single Shunt Sensor-less Vector Control of PMSM Motors – Document: R01AN0901EU

Three Shunt Sensor-less Vector Control of PMSM Motor with Internal Programmable Gain Amplifier (PGA) – Document: R01AN0902EU

Single Shunt Sensor-less Vector Control of PMSM Motor with Internal Programmable Gain Amplifier (PGA) – Document: R01AN0900EU

Position Control of PMSM Motors with Encoder – Document: R01AN0899EU

Plus:

RX62T Motor Control Kit Hardware User Guide – Document D011060_11_V0100

RX62T Motor Control Kit GUI User Guide – Document D011061_11_V0100

RX62T Group User's Manual: Hardware – Document: R01UH0034EJ

RX Compiler Package User's Manual – Document: R20UT0570EJ

High-performance Embedded Workshop IDE user's Manual – Document: R20UT0372EJ

RX62T Group datasheet – Document: R01DS0096EJ

RJK0656DPB Silicon N Channel Power MOS FET Datasheet – Document: REJ03G1882

YMCRPRX62T_Schematic.pdf – Board Schematic for YMCRPRX62T

Motor_BLY171D-24V-4000-05.pdf – Motor specifications



YMCRPRX62T: RX62T Motor Control Evaluation Kit Quick Start Guide

Support

Online technical support and information is available at: www.renesas.com/rxmotorkit

Technical Contact Details

America: techsupport.america@renesas.com

Note on Autoupdate: The Autoupdater is configured to automatically add itself to the Startup folder in the Windows Start Menu and use the registry defaults for access to the web. After restarting the machine the Icon will appear in the System Tray next to the clock. To change the settings or access Autoupdate, simply right-click on the icon and use the menu that appears.

Renesas RX Compiler – Evaluation version

The product is supplied with an Evaluation version of the Renesas RX C/C++ compiler tool-chain:-

Tool-chain	Version	CPUs	License
Renesas RX	1.02.00.000	RX200, RX600	60 day full, then 128K code limit

The version of the compiler provided with this kit is fully functional but time limited. You have 60 days to evaluate the full product before the compiler will limit the code linker to 128k bytes – note that this limit includes both code and data segments.

Full licensed RX compiler versions are available from your Renesas supplier.



YMCRPRX62T: RX62T Motor Control Evaluation Kit Quick Start Guide

Copyright

© 2012 Renesas Electronics America Inc

© 2012 Renesas Electronics Europe Ltd.

© 2012 Renesas Electronics Corporation.

© 2012 Renesas Solution Corporation.

All rights reserved.

Website: www.renesas.com

Printed in EU