

AMD ZCU102 with Renesas ClockMatrix, ITU-T G.8273.4 PTS

Contents

1. Results Summary	3
1.1 Notes on Testing with a Physical Layer Clock	3
1.2 Notes on Single Path Operation	4
2. Test Configuration	5
3. G.8273.4 PTS: Noise Generation	8
3.1 ONEPPS Analysis	9
3.2 CTE Analysis	10
3.3 DTE Analysis	11
3.4 DTEHF Analysis	12
4. G.8273.4 PTS: Holdover	13
4.1 TIE Analysis	14
5. G.8273.4 PTS: Noise Generation – SyncE Assistance	15
5.1 ONEPPS Analysis	16
5.2 CTE Analysis	17
5.3 DTE Analysis	18
5.4 DTEHF Analysis	19
6. G.8273.4 PTS: Holdover – SyncE Assistance	20
6.1 TIE Analysis	21
7. G.8273.4 PTS: Noise Generation – Single Path	22
7.1 ONEPPS Analysis	23
7.2 CTE Analysis	24
7.3 DTE Analysis	25
7.4 DTEHF Analysis	26
8. G.8273.4 PTS: Holdover – Single Path	27
8.1 TIE Analysis	28
9. G.8273.4 PTS: Noise Tolerance – ITU-T G.8271.2 PDV Pattern	29
9.1 ONEPPS Analysis	30
10. G.8273.4 PTS: Noise Tolerance– ITU-T G.8271.2 PDV Pattern – SyncE Assistance	31
10.1 ONEPPS Analysis	32
11.1 ONEPPS Analysis	34
12. G.8273.4 PTS: Noise Tolerance – No BC’s High Stability PDV	35
12.1 ONEPPS Analysis	36
13. G.8273.4 PTS: Noise Tolerance – No BC’s Normal Stability PDV	37
13.1 ONEPPS Analysis	38
14. G.8273.4 PTS: Noise Tolerance – With BC’s High Stability PDV	39
14.1 ONEPPS Analysis	40

15. G.8273.4 PTS: Noise Tolerance – With BC’s Normal Stability PDV	41
15.1 ONEPPS Analysis	42
16. G.8273.4 PTS: Noise Tolerance – No BC’s High Stability PDV – SyncE Assistance	43
16.1 ONEPPS Analysis	44
17.1 ONEPPS Analysis	46
18. G.8273.4 PTS: Noise Tolerance – With BC’s High Stability PDV – SyncE Assistance	47
18.1 ONEPPS Analysis	48
19. G.8273.4 PTS: Noise Tolerance – With BC’s Normal Stability PDV – SyncE Assistance	49
19.1 ONEPPS Analysis	50
20. G.8273.4 PTS: Noise Tolerance – No BC’s High Stability PDV – Single Path	51
20.1 ONEPPS Analysis	52
21. G.8273.4 PTS: Noise Tolerance – No BC’s Normal Stability PDV – Single Path	53
21.1 ONEPPS Analysis	54
22. Revision History	55

1. Results Summary

Standard	Test Case	Results
G.8273.4 PTS	Noise Generation	Pass
G.8273.4 PTS	Holdover	Pass
G.8273.4 PTS	Noise Generation – SyncE Assistance	Pass
G.8273.4 PTS	Holdover – SyncE Assistance	Pass
G.8273.4 PTS	Noise Generation – Single Path	Pass
G.8273.4 PTS	Holdover – Single Path	Pass
G.8273.4 PTS	Noise Tolerance – ITU-T G.8271.2 PDV Pattern	Pass
G.8273.4 PTS	Noise Tolerance – ITU-T G.8271.2 PDV Pattern – SyncE Assistance	Pass
G.8273.4 PTS	Noise Tolerance – ITU-T G.8271.2 PDV Pattern – Single Path	Pass
G.8273.4 PTS	Noise Tolerance – No BC’s High Stability PDV	Pass
G.8273.4 PTS	Noise Tolerance – No BC’s Normal Stability PDV	Pass
G.8273.4 PTS	Noise Tolerance – With BC’s High Stability PDV	Pass
G.8273.4 PTS	Noise Tolerance – With BC’s Normal Stability PDV	Pass
G.8273.4 PTS	Noise Tolerance – No BC’s High Stability PDV – SyncE Assistance	Pass
G.8273.4 PTS	Noise Tolerance – No BC’s Normal Stability PDV – SyncE Assistance	Pass
G.8273.4 PTS	Noise Tolerance – With BC’s High Stability PDV – SyncE Assistance	Pass
G.8273.4 PTS	Noise Tolerance – With BC’s Normal Stability PDV – SyncE Assistance	Pass
G.8273.4 PTS	Noise Tolerance – No BC’s High stability PDV – Single Path	Pass
G.8273.4 PTS	Noise Tolerance – No BC’s Normal Stability PDV – Single Path	Pass

1.1 Notes on Testing with a Physical Layer Clock

PTS with SyncE Assistance test uses a SyncE clock from the test equipment as an additional clock source. In both cases, a DPLL (configured for ITU-T G.8262 EEC1) is locked to the SyncE source and is connected to the PTP DPLL via the combo bus. For FTS there is no filter on the combo bus connection. For PTS with SyncE Assistance there is a 3mHz filter on the combo bus connection.

Synced software is used to manage the SyncE clock based on the QL level from the test equipment for tests required a physical layer clock. A category 1 (QL-PRTC) SyncE source from the test equipment is connected to the SyncE input on Clock Matrix and is qualified before PTP (PCM4L/PTP4I) is started.

1.2 Notes on Single Path Operation

When operating in single path mode, only the Sync packets from the master are used for timing. This results in an unknown floor delay. In PTS mode a floor delay is manually entered by the user in the PCM4L Json file:

```
"floorDelayEstimateSeconds": 0.000008800,
```

The test description contains the floor delay estimate used in each case. The floor delay estimate changes depending on the PDV pattern being tested as well as the inherent delay in the measurement device.

PDV noise cases “With BC’s Normal Stability” and “With BC’s High Stability” were omitted as they are not applicable to the Single Path use case.

Notes on Testing with SyncE Assistance

SyncE from the Calnex measurement equipment (Paragon Neo and Paragon X) is used as the physical layer assistance for each test in this report. The quality level of the SyncE level is manually set greater than or equal to the quality level threshold in the PCM4LJson configuration file.

```
"physicalPllClockCategory": 1,  
"physicalPllClockCategoryThreshold": 1,
```

The SyncE recovered clock is an input to a DPLL channel running in DPLL Mode with the G.8262 EEC1 preset. The output from this DPLL is filtered (3mHz filter bandwidth) and used as a combo source for the PTP DPLL.

2. Test Configuration

Table 1. Configuration 1

Device Under Test	AMD + CM
Oscillator	Rakon M6141 MiniOcxo
1pps Source	Symmetricom TP5000
Instrument	Paragon Neo
Instrument Serial Number	00036081
Ethernet Interface	Optical
Sections using this Configuration	3, 4, 7, 8, 9, 11–15

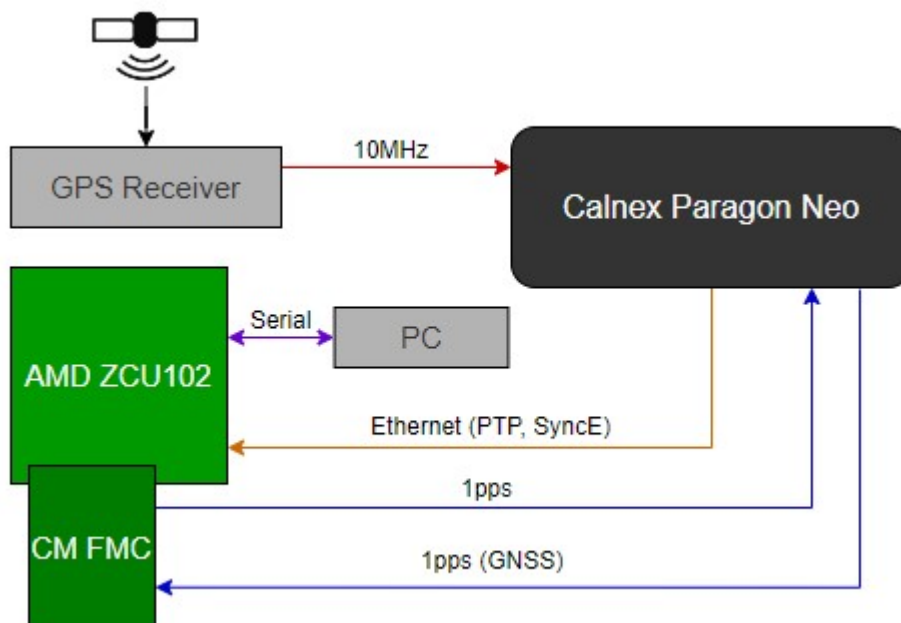

Figure 1. Equipment Configuration 1

Table 2. Test Configuration 2

Device Under Test	AMD + CM
Oscillator	Rakon STP3296LF OCXO
1pps Source	Symmetricom TP5000
Instrument	Paragon X
Instrument Serial Number	25060
Ethernet Interface	Optical
Sections using this Configuration	5, 6, 10

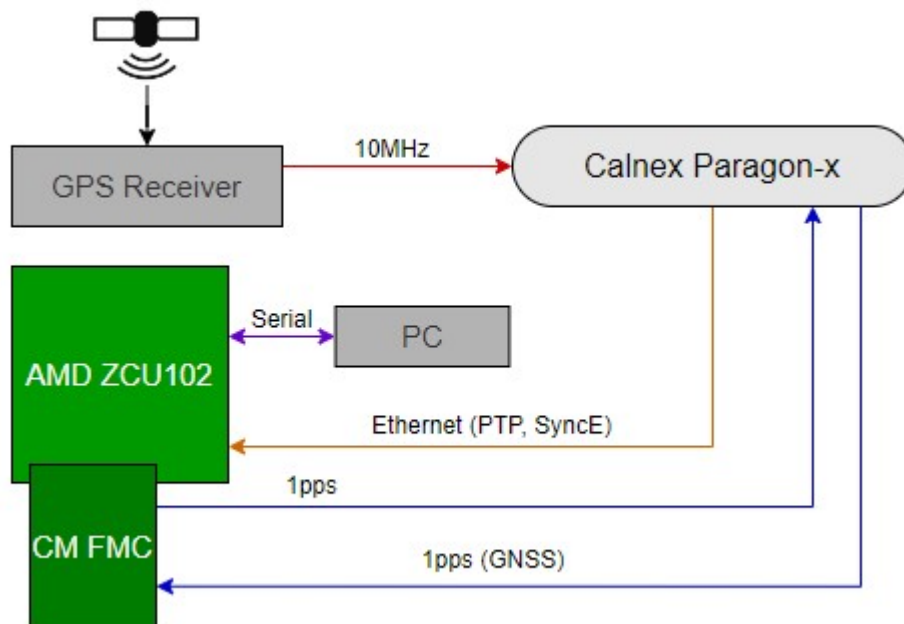

Figure 2. Equipment Configuration 2

Table 3. Test Configuration 3

Device Under Test	AMD + CM
Oscillator	Rakon M6141 TCXO
1pps Source	Symmetricom TP5000
Instrument	Paragon X
Instrument Serial Number	25060
Ethernet Interface	Optical
Sections using this Configuration	16–21

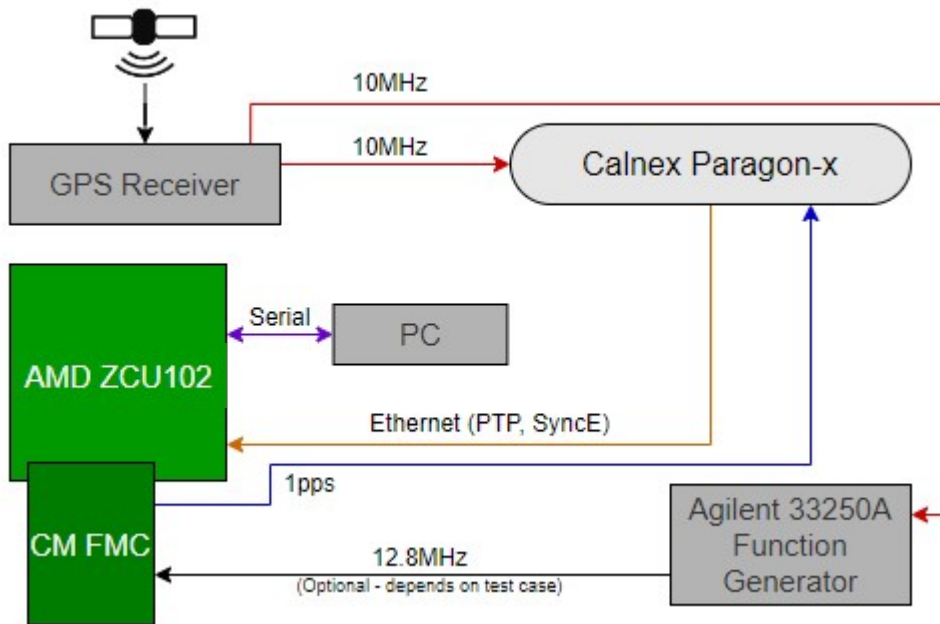

Figure 3. Equipment Configuration 3

3. G.8273.4 PTS: Noise Generation

Test Description	Noise Generation
Report Date	22-10-18_08-30-41
Packet Rate (pkt/s)	16
Test Duration	02:46:40
Test Configuration	1
Time to Phase Lock (s)	63

All Mask Results	Pass
Mask ONEPPS	1.35μs
Mask ONEPPS Result	Pass
Mask CTE	0.02μs
Mask CTE Result	Pass
Mask DTE	0.2μs
Mask DTE Result	Pass
Mask DTEHF	-
Mask DTEHF Result	No Mask

3.1 ONEPPS Analysis

Offset Removal Applied	Off
Zero Offset	31.697ns

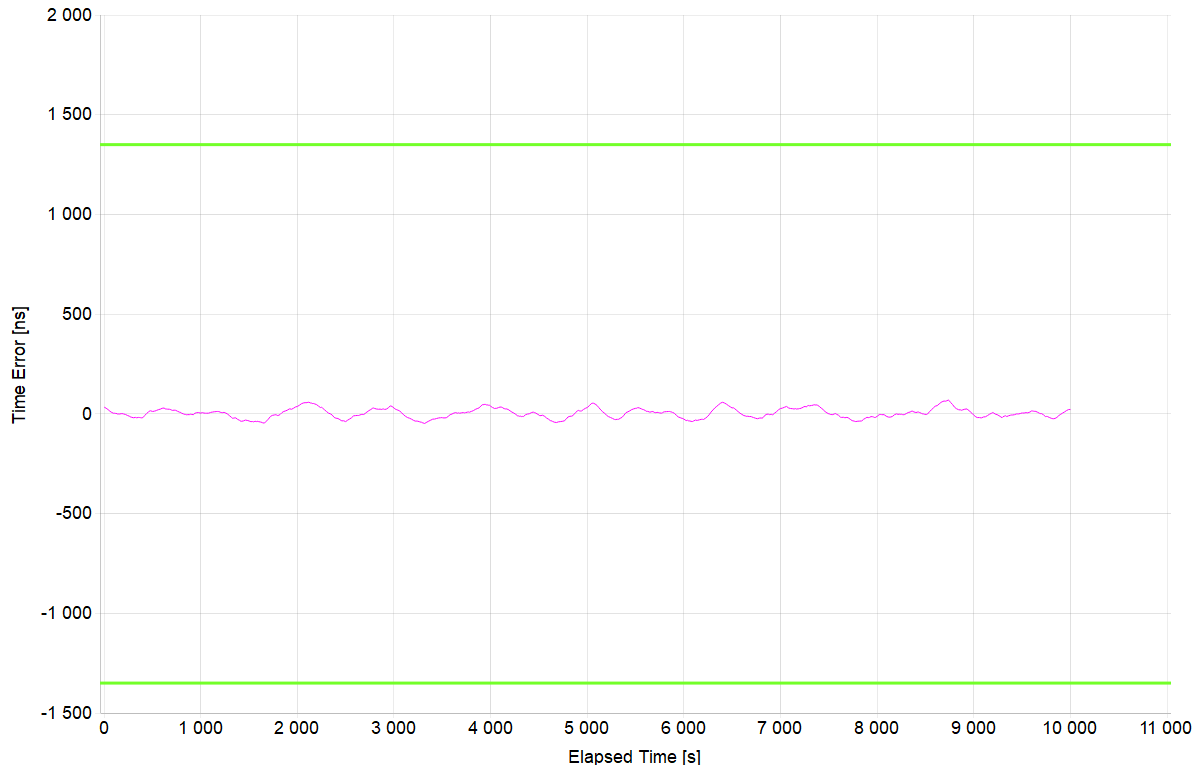

Mean [ns]	2.941
Min [ns]	-48.303
Max [ns]	69.447
Max-Min [ns]	117.75

3.2 CTE Analysis

Averaging Time (s)	1000
---------------------------	------

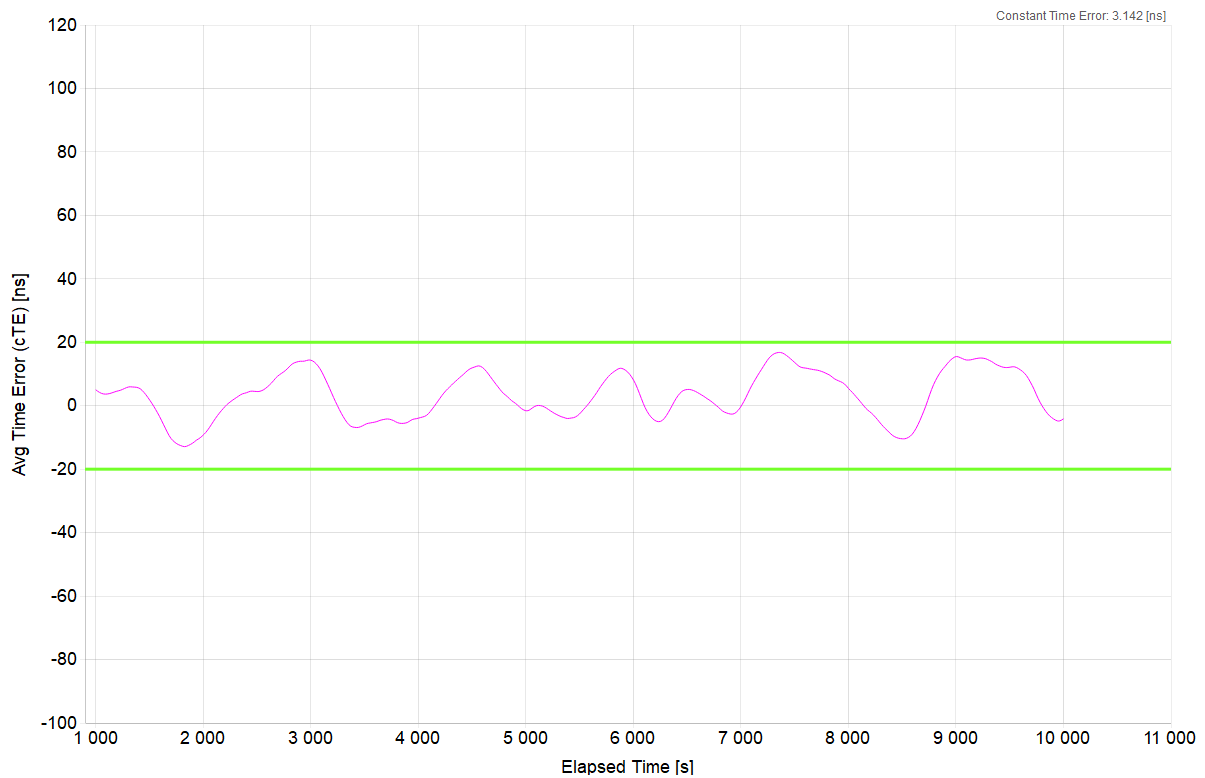

Constant Time Error [ns]	3.142
Min [ns]	-12.892
Max [ns]	16.797
Max-Min [ns]	29.689

3.3 DTE Analysis

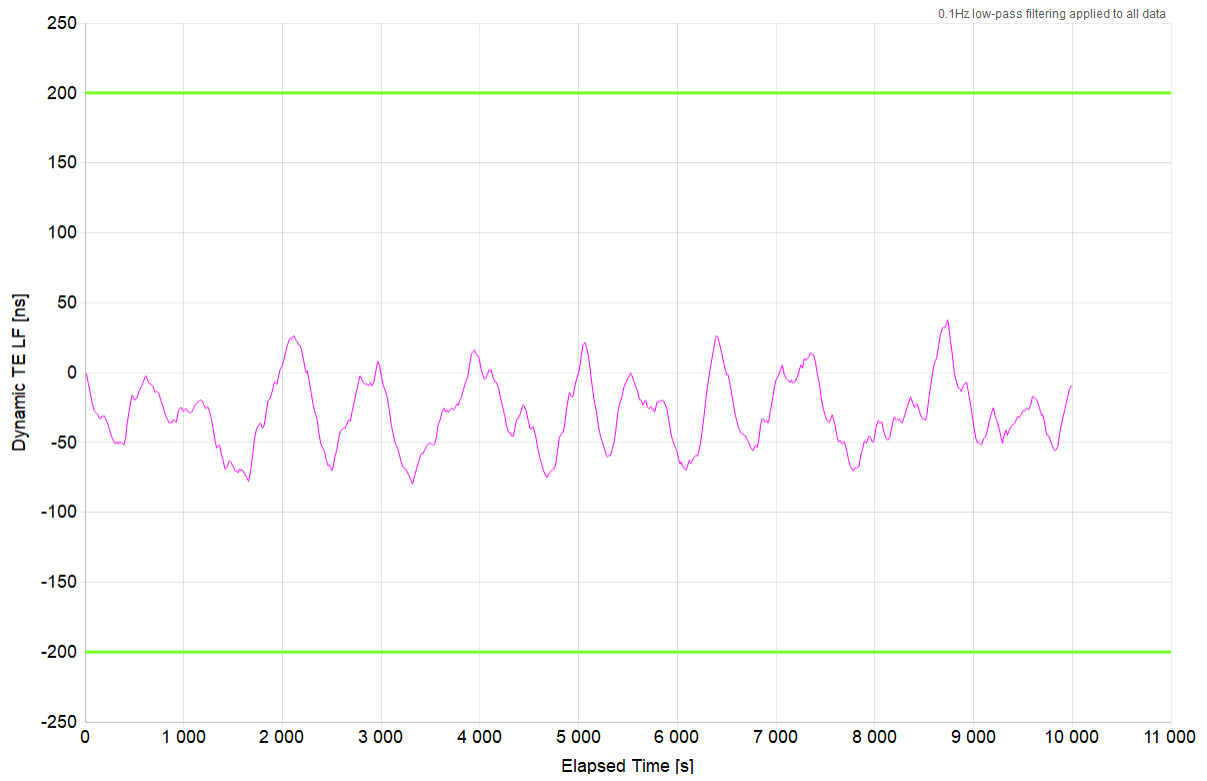

Mean [ns]	-28.797
Min [ns]	-79.843
Max [ns]	37.595
Max-Min [ns]	117.438

3.4 DTEHF Analysis

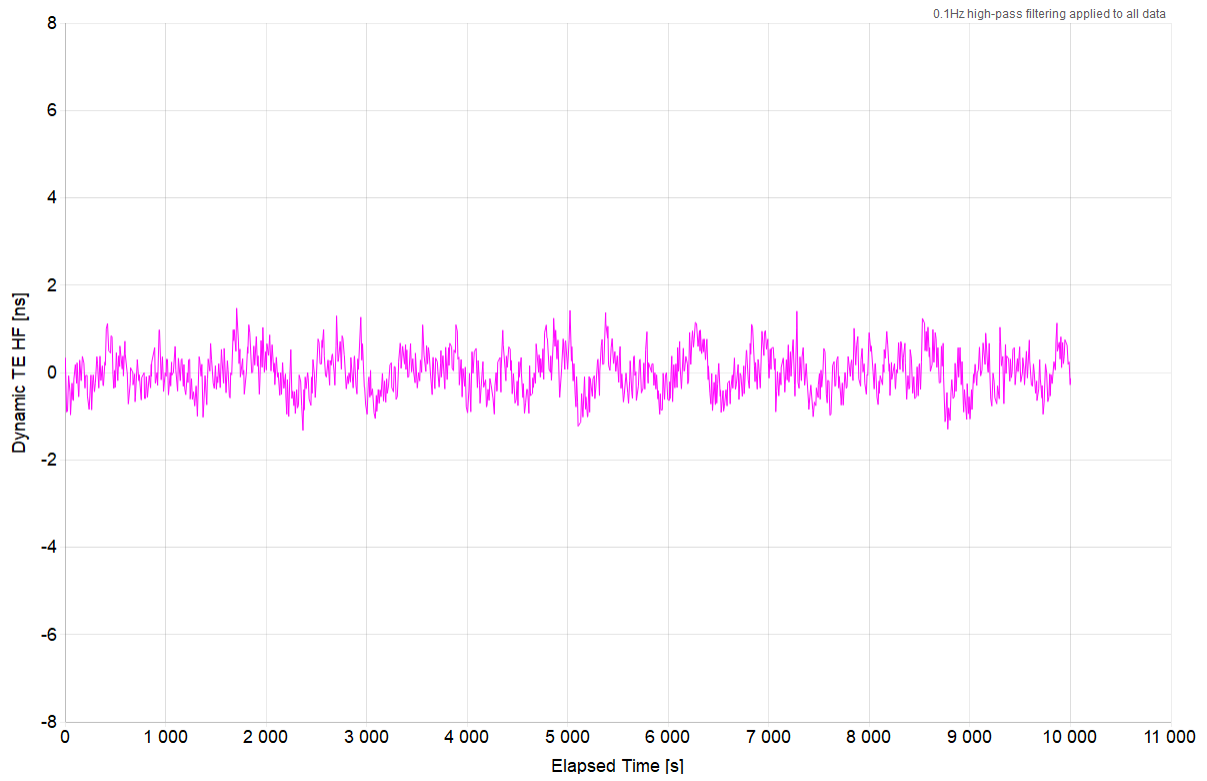

Mean [ns]	-0.002
Min [ns]	-1.328
Max [ns]	1.472
Max-Min [ns]	2.8

4. G.8273.4 PTS: Holdover

Test Description	Holdover
Report Date	22-10-18_08-30-41
Packet Rate (pkt/s)	16
Test Duration	00:16:37
Test Configuration	1
Time to Phase Lock (s)	63

All Mask Results	Pass
Mask TIE	G.8273.4 PTS Holdover (Oscillator) Const. Temp.
Mask TIE Result	Pass

1. This test is a continuation of the previous Noise Generation test. This allows for an appropriate amount of settling time before collecting holdover data (10 000s). The results are split because holdover requires a different mask than noise generation.

4.1 TIE Analysis

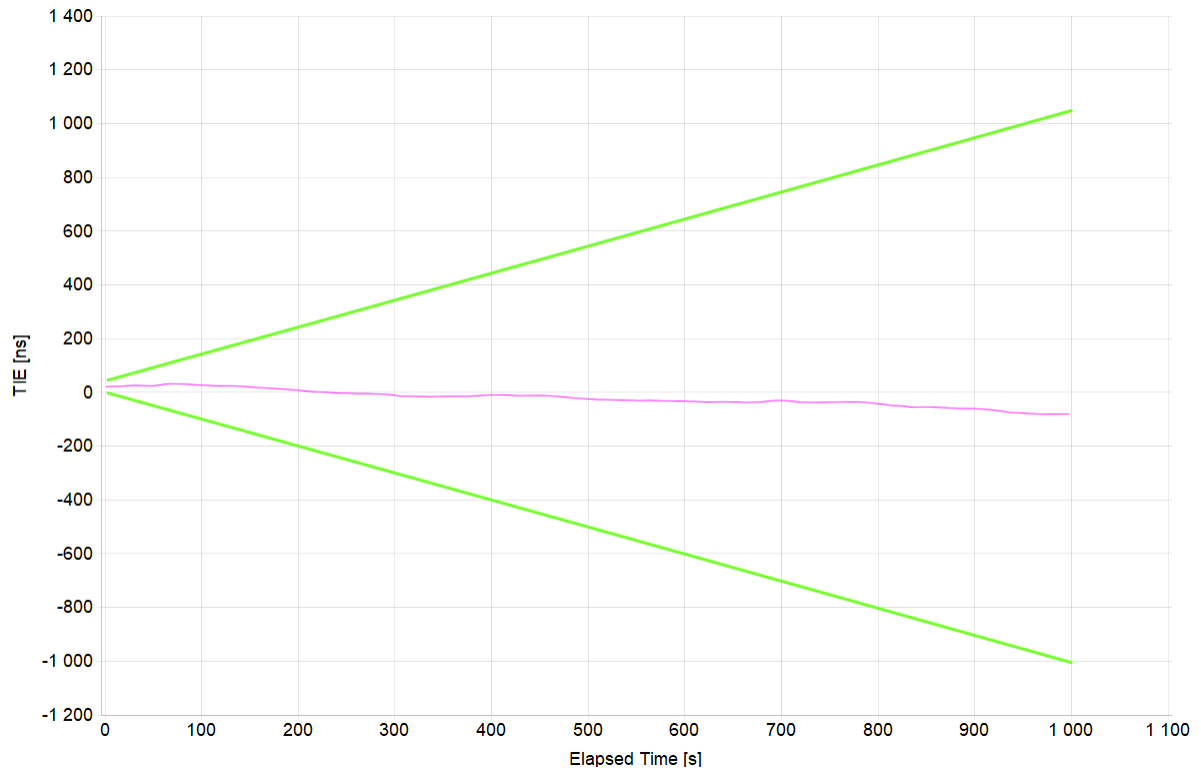

Mean [ns]	-21.438
Min [ns]	-81.303
Max [ns]	31.947
Max-Min [ns]	113.25

5. G.8273.4 PTS: Noise Generation – SyncE Assistance

Test Description	Noise Generation
Report Date	22-10-18_08-30-41
Packet Rate (pkt/s)	16
Test Duration	02:46:40
Test Configuration	2
Time to Phase Lock (s)	57

All Mask Results	Pass
Mask ONEPPS	1.35µs
Mask ONEPPS Result	Pass
Mask CTE	0.02µs
Mask CTE Result	Pass
Mask DTE	0.2µs
Mask DTE Result	Pass
Mask DTEHF	-
Mask DTEHF Result	No Mask

5.1 ONEPPS Analysis

Offset Removal Applied	Off
Zero Offset	3.553ns

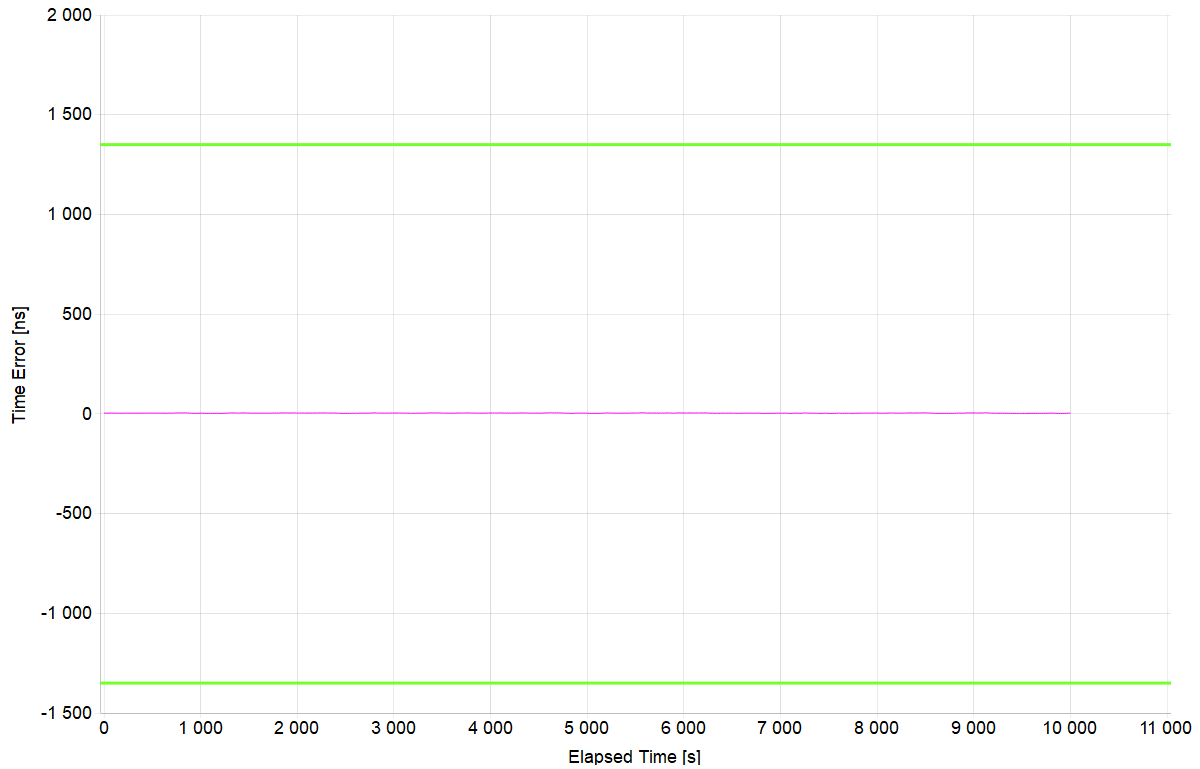

Mean [ns]	3.591
Min [ns]	1.553
Max [ns]	5.553
Max-Min [ns]	4

5.2 CTE Analysis

Averaging Time (s)	1000
---------------------------	------

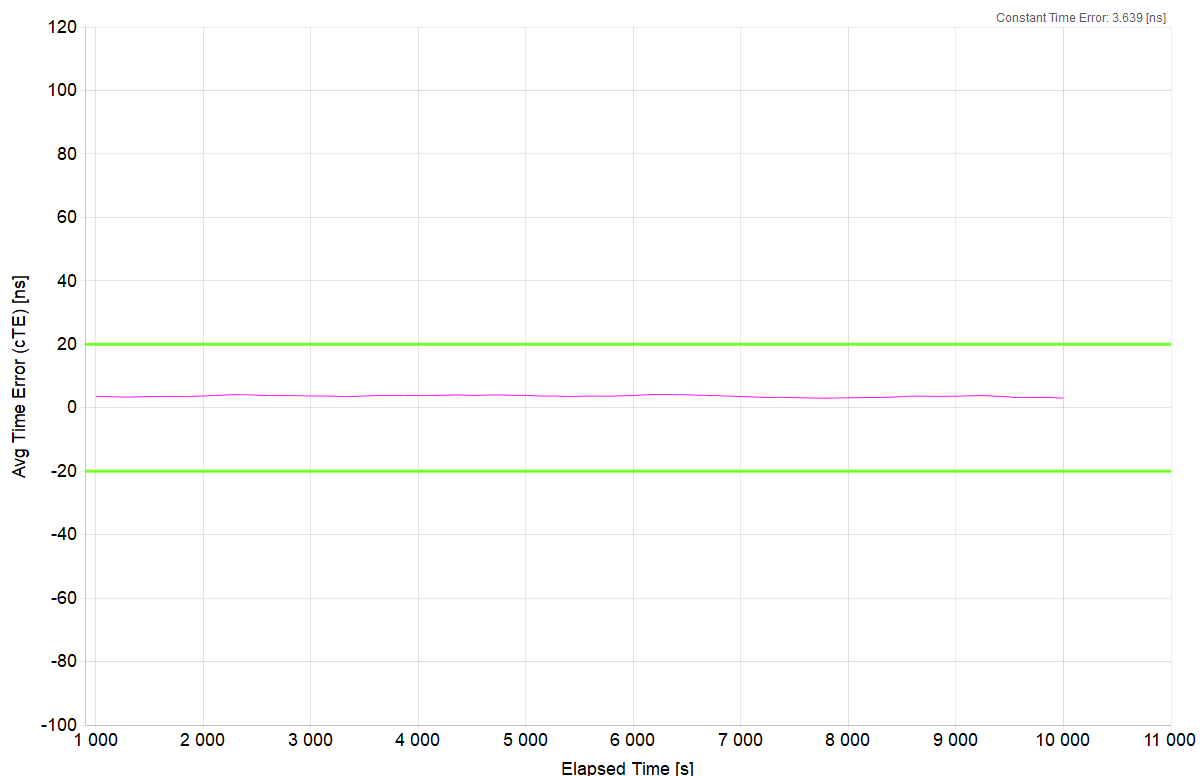

Constant Time Error [ns]	3.639
Min [ns]	2.975
Max [ns]	4.173
Max-Min [ns]	1.198

5.3 DTE Analysis

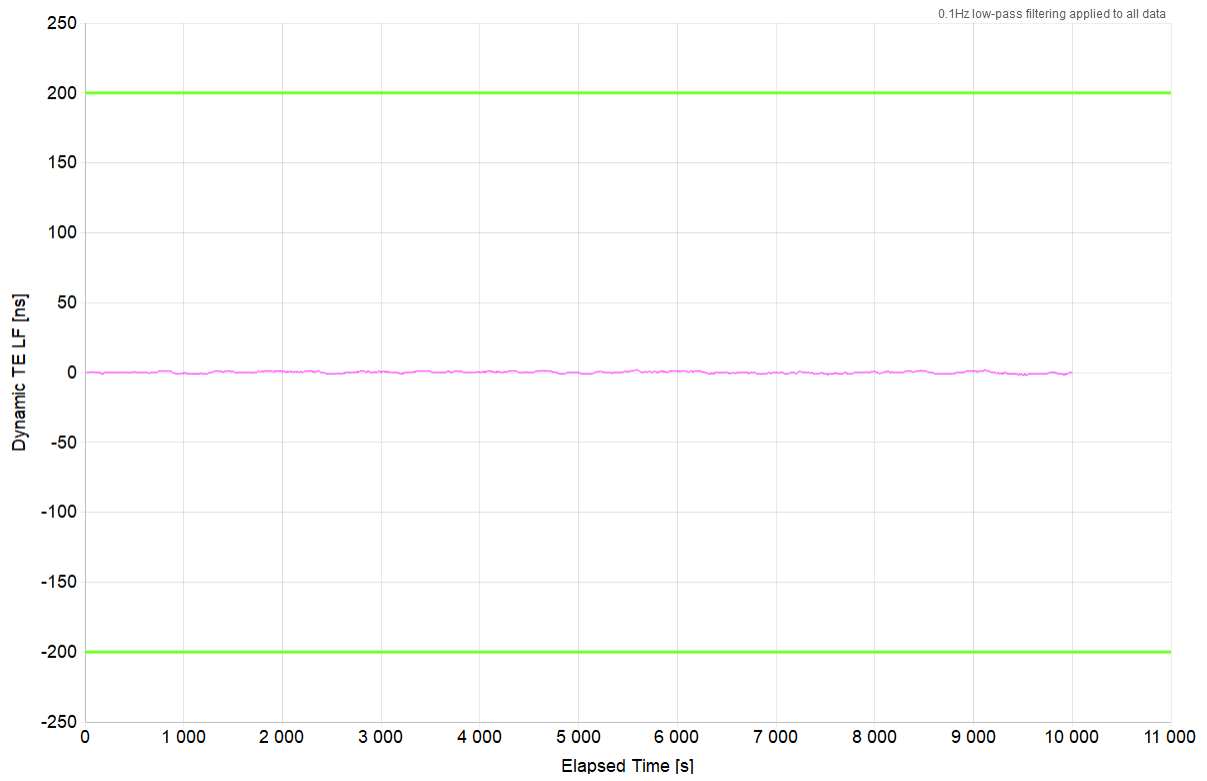

Mean [ns]	0.038
Min [ns]	-2
Max [ns]	2
Max-Min [ns]	4

5.4 DTEHF Analysis

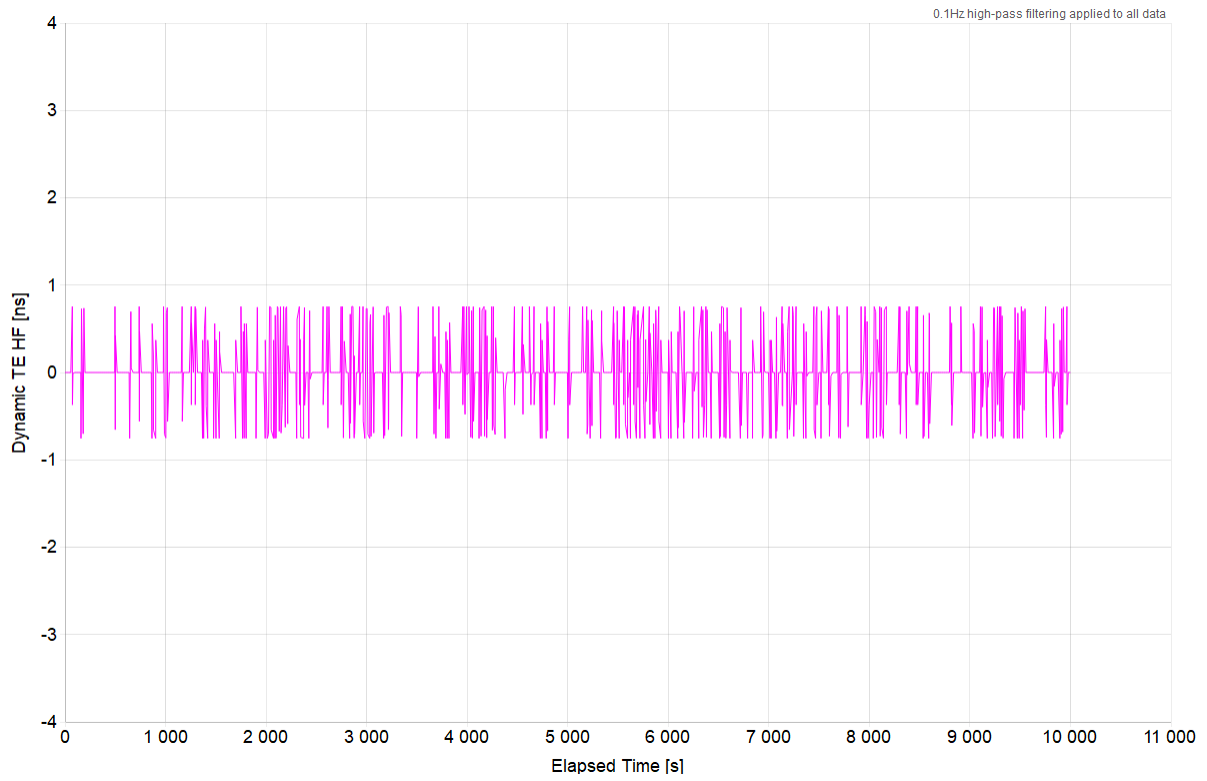

Mean [ns]	0
Min [ns]	-0.755
Max [ns]	0.755
Max-Min [ns]	1.51

6. G.8273.4 PTS: Holdover – SyncE Assistance

Test Description	Holdover
Report Date	22-10-18_08-30-41
Packet Rate (pkt/s)	16
Test Duration	00:16:40
Test Configuration	2
Time to Phase Lock (s)	N/A

All Mask Results	Pass
Mask TIE	G.8273.4 PTS Holdover (Oscillator) Const. Temp.
Mask TIE Result	Pass

1. This test is a continuation of the previous Noise Generation test. This allows for an appropriate amount of settling time before collecting holdover data (10 000s). The results are split because holdover requires a different mask than noise generation.

6.1 TIE Analysis

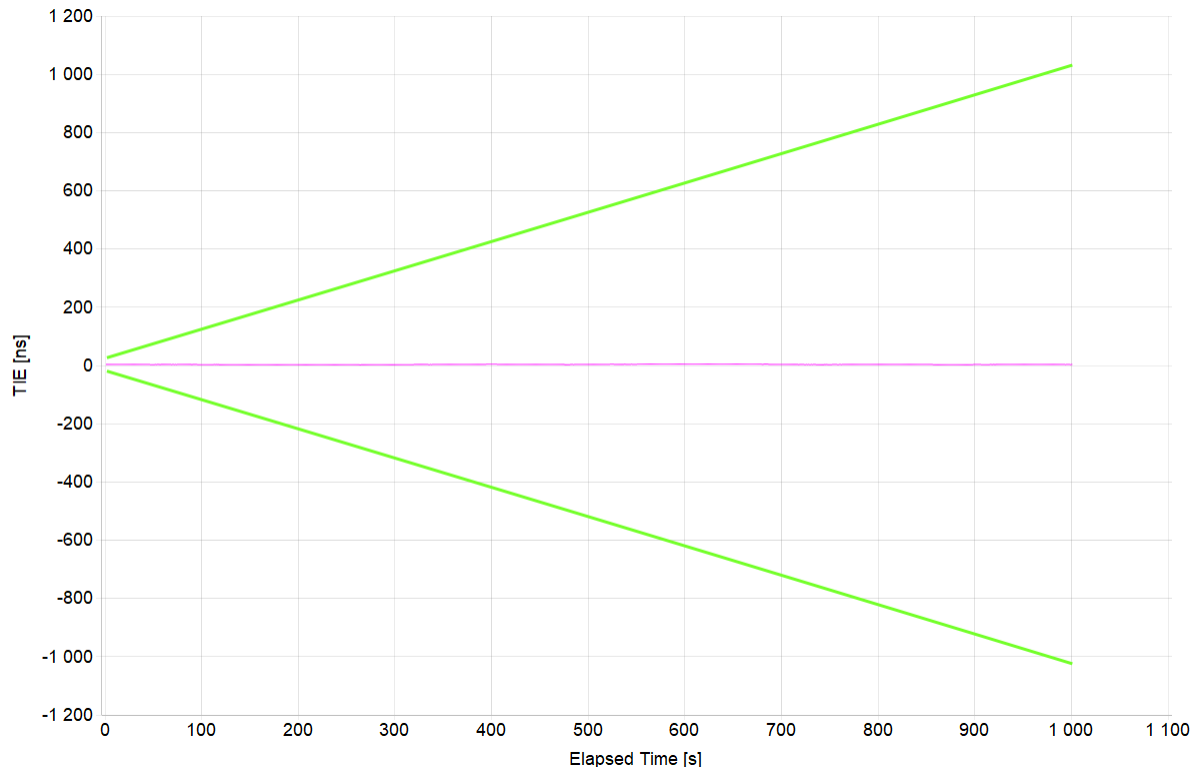

Mean [ns]	3.381
Min [ns]	1.553
Max [ns]	4.553
Max-Min [ns]	3

7. G.8273.4 PTS: Noise Generation – Single Path

Test Description	Noise Generation
Report Date	22-04-26_10-11-31
Packet Rate (pkt/s)	16
Test Duration	02:46:40
Test Configuration	1
Time to Phase Lock (s)	64
Floor Delay Estimate (ns)	8800

All Mask Results	Pass
Mask ONEPPS	1.35μs
Mask ONEPPS Result	Pass
Mask CTE	0.02μs
Mask CTE Result	Pass
Mask DTE	0.2μs
Mask DTE Result	Pass
Mask DTEHF	-
Mask DTEHF Result	No Mask

7.1 ONEPPS Analysis

Offset Removal Applied	Off
Zero Offset	15.047ns

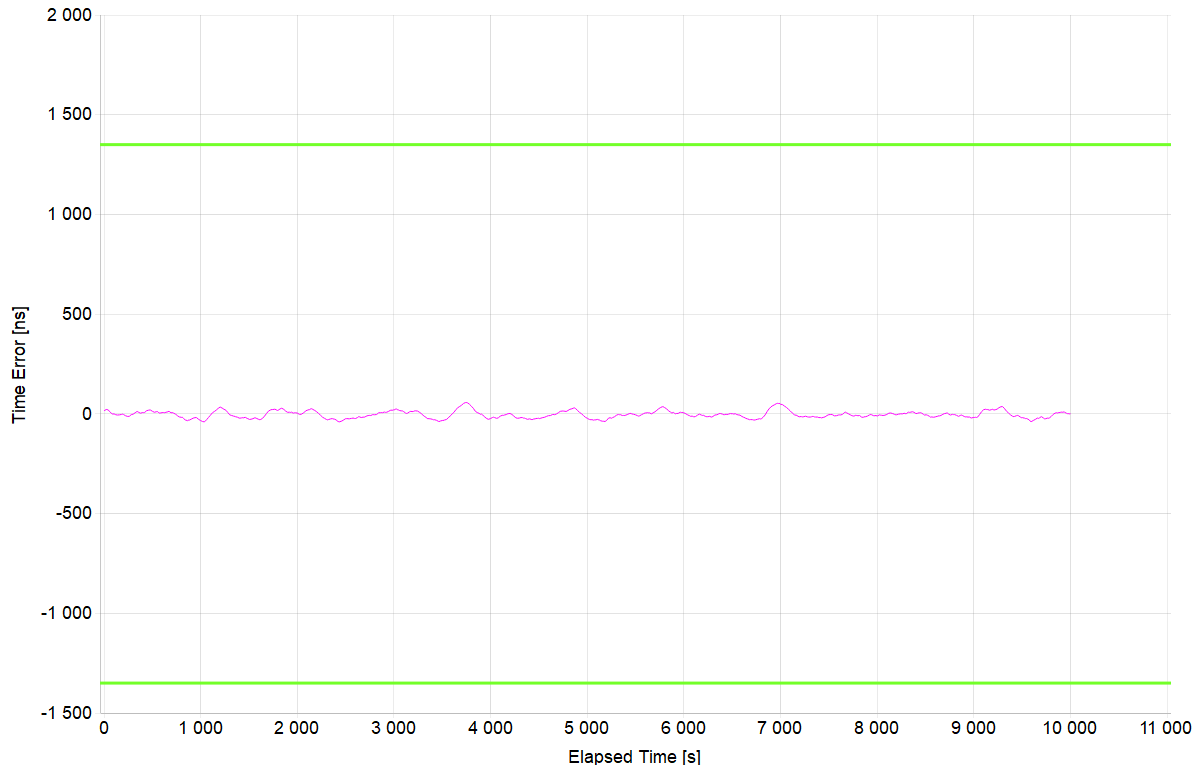

Mean [ns]	-3.598
Min [ns]	-40.453
Max [ns]	57.047
Max-Min [ns]	97.5

7.2 CTE Analysis

Averaging Time (s)	1000
---------------------------	------

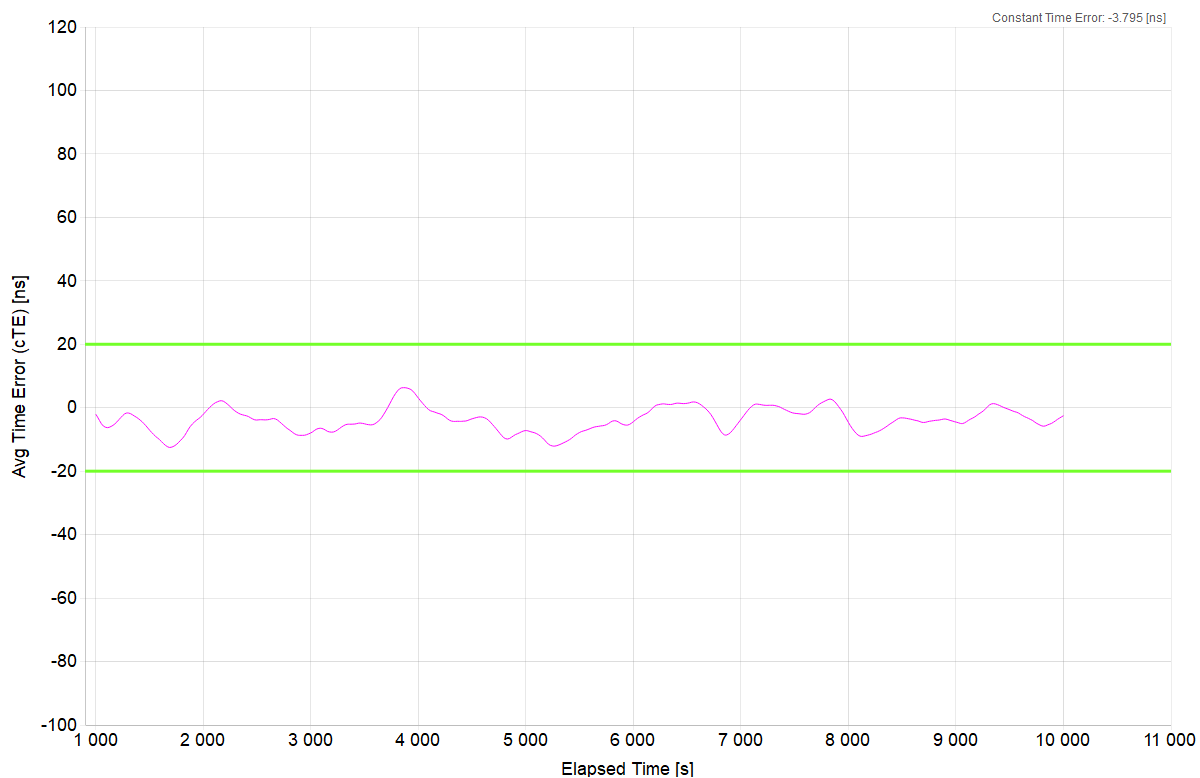

Constant Time Error [ns]	-3.795
Min [ns]	-12.524
Max [ns]	6.319
Max-Min [ns]	18.843

7.3 DTE Analysis

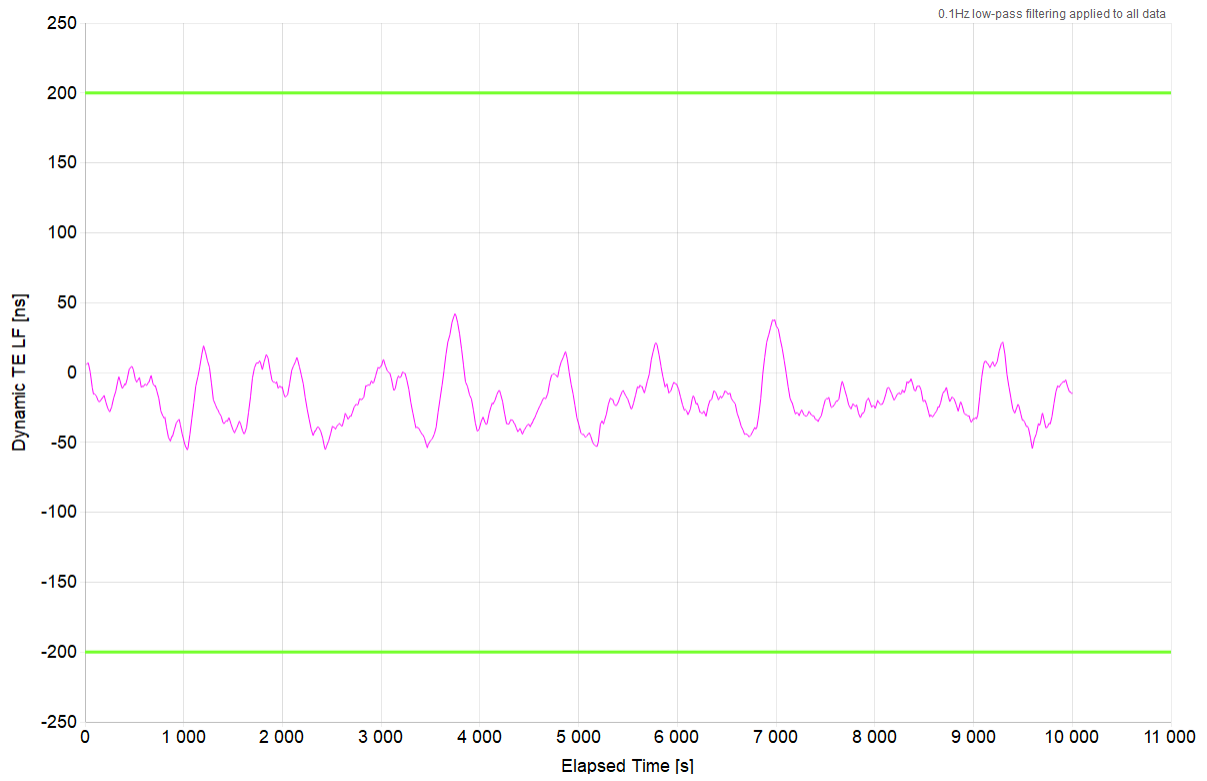

Mean [ns]	-18.675
Min [ns]	-55.349
Max [ns]	41.973
Max-Min [ns]	97.322

7.4 DTEHF Analysis

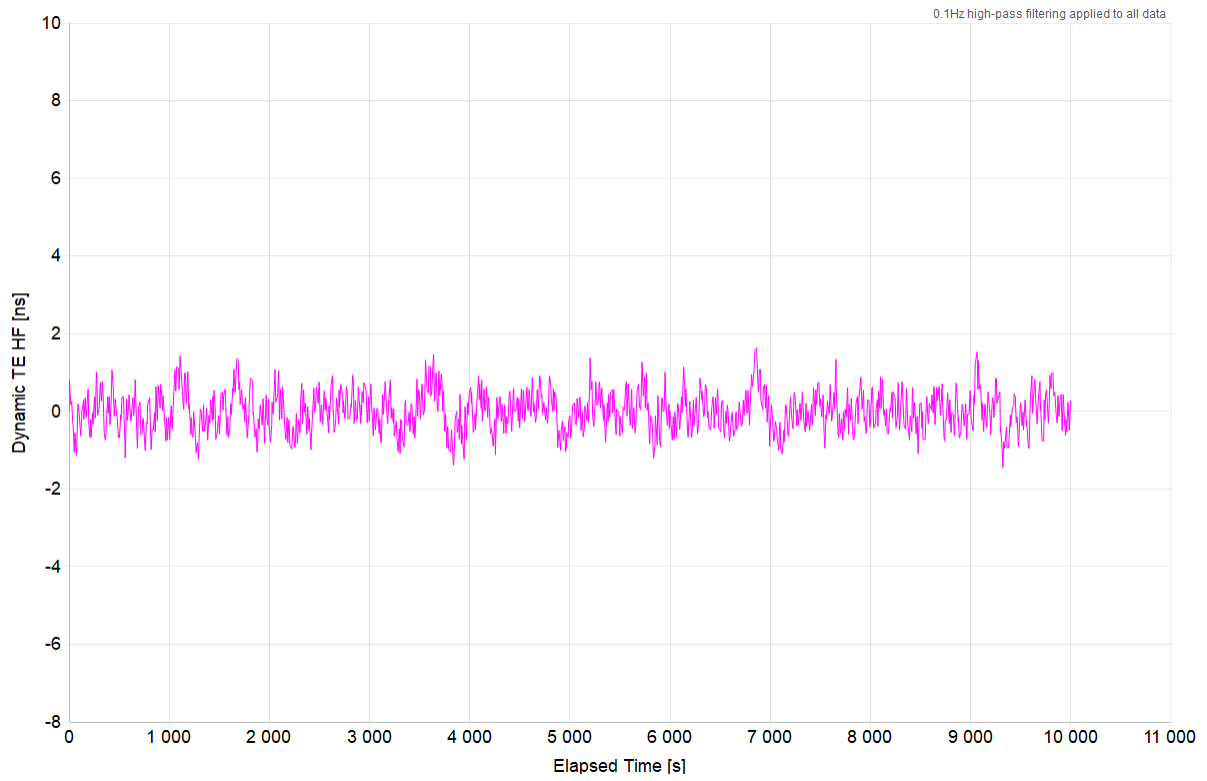

Mean [ns]	-0.002
Min [ns]	-1.443
Max [ns]	1.628
Max-Min [ns]	3.071

8. G.8273.4 PTS: Holdover – Single Path

Test Description	Holdover
Report Date	22-04-26_10-11-31
Packet Rate (pkt/s)	16
Test Duration	00:16:40
Test Configuration	1
Time to Phase Lock (s)	N/A
Floor Delay Estimate (ns)	8800

All Mask Results	Pass
Mask TIE	G.8273.4 PTS Holdover (Oscillator) Const. Temp.
Mask TIE Result	Pass

1. This test is a continuation of the previous Noise Generation test. This allows for an appropriate amount of settling time before collecting holdover data (10 000s). The results are split because holdover requires a different mask than noise generation.

8.1 TIE Analysis

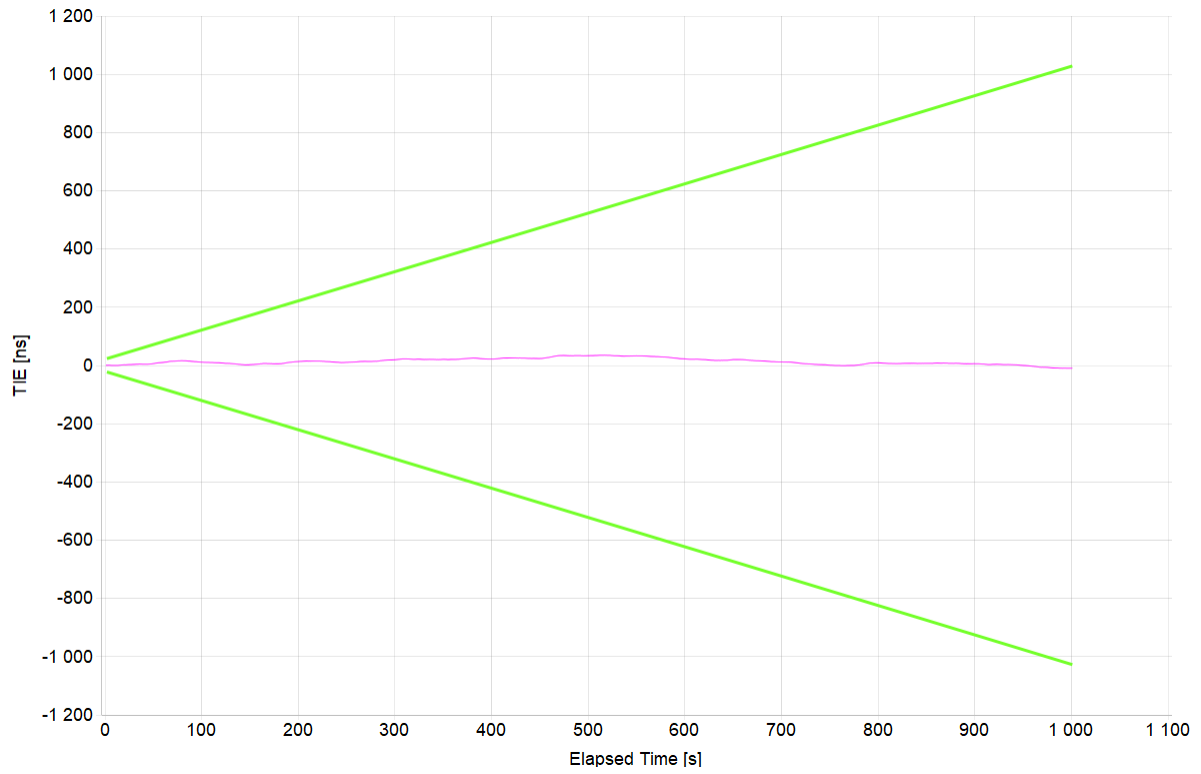

Mean [ns]	13.818
Min [ns]	-9.453
Max [ns]	35.297
Max-Min [ns]	44.75

9. G.8273.4 PTS: Noise Tolerance – ITU-T G.8271.2 PDV Pattern

Test Description	Noise Tolerance– ITU-T G.8271.2 PDV Pattern
Report Date	22-10-18_08-30-41
Packet Rate (pkt/s)	16
Test Duration	08:03:18
Test Configuration	1
Time to Phase Lock (s)	1261

All Mask Results	Pass
Mask ONEPPS	1.35μs
Mask ONEPPS Result	Pass

9.1 ONEPPS Analysis

Offset Removal Applied	Off
Zero Offset	70.447ns

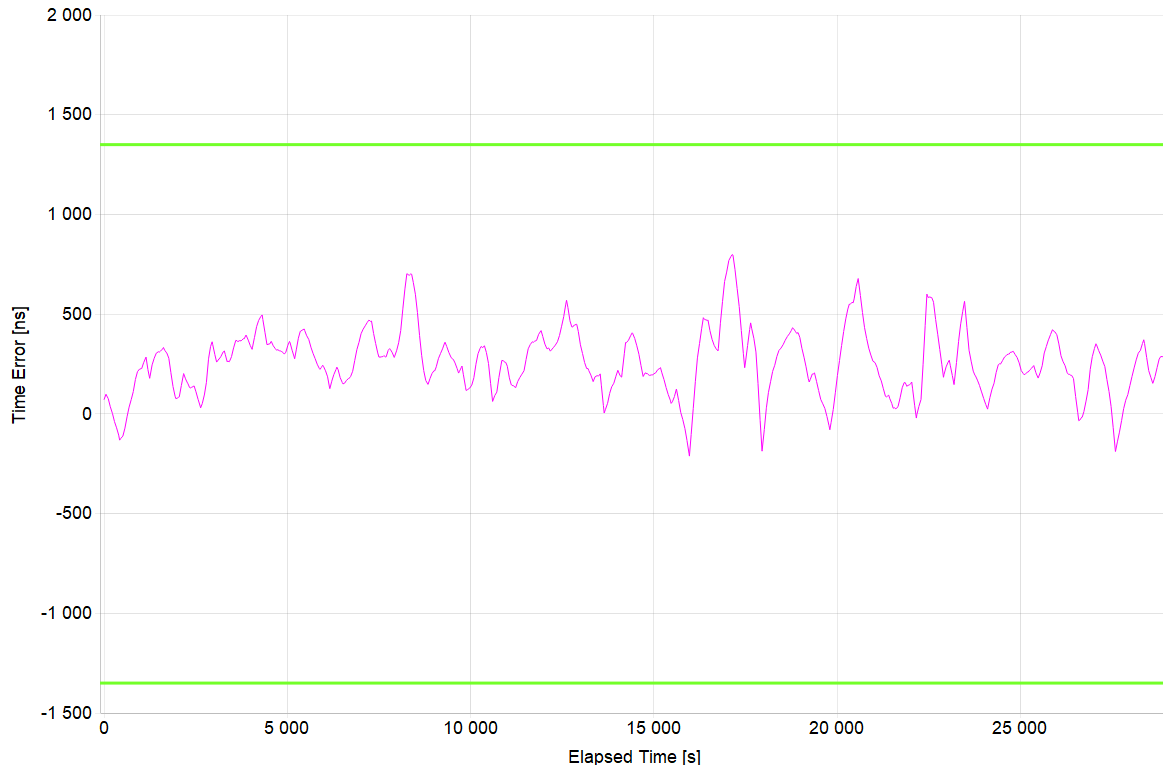

Mean [ns]	257.979
Min [ns]	-211.803
Max [ns]	798.947
Max-Min [ns]	1010.75

10. G.8273.4 PTS: Noise Tolerance– ITU-T G.8271.2 PDV Pattern – SyncE Assistance

Test Description	Noise Tolerance– ITU-T G.8271.2 PDV Pattern – SyncE Assistance
Report Date	22-10-18_08-30-41
Packet Rate (pkt/s)	16
Test Duration	08:03:18
Test Configuration	2
Time to Phase Lock (s)	312

All Mask Results	Pass
Mask ONEPPS	1.35µs
Mask ONEPPS Result	Pass

10.1 ONEPPS Analysis

Offset Removal Applied	Off
Zero Offset	313ns

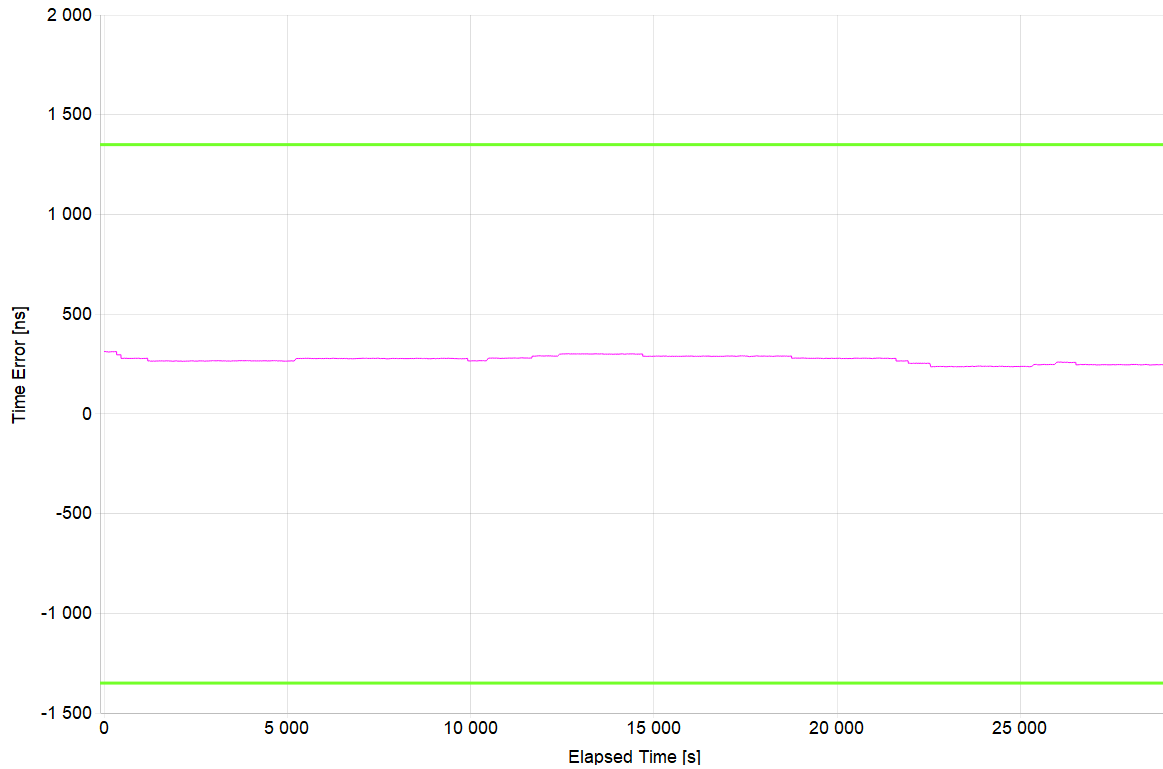

Mean [ns]	271.854
Min [ns]	236
Max [ns]	313
Max-Min [ns]	77

11. G.8273.4 PTS: Noise Tolerance – ITU-T G.8271.2 PDV Pattern – Single Path

Test Description	Noise Tolerance – ITU-T G.8271.2 PDV Pattern
Report Date	22-04-26_09-52-35
Packet Rate (pkt/s)	16
Test Duration	07:10:00
Test Configuration	1
Time to Phase Lock (s)	1739
Floor Delay Estimate (ns)	108800

All Mask Results	Pass
Mask ONEPPS	1.35µs
Mask ONEPPS Result	Pass

11.1 ONEPPS Analysis

Offset Removal Applied	Off
Zero Offset	193.047ns

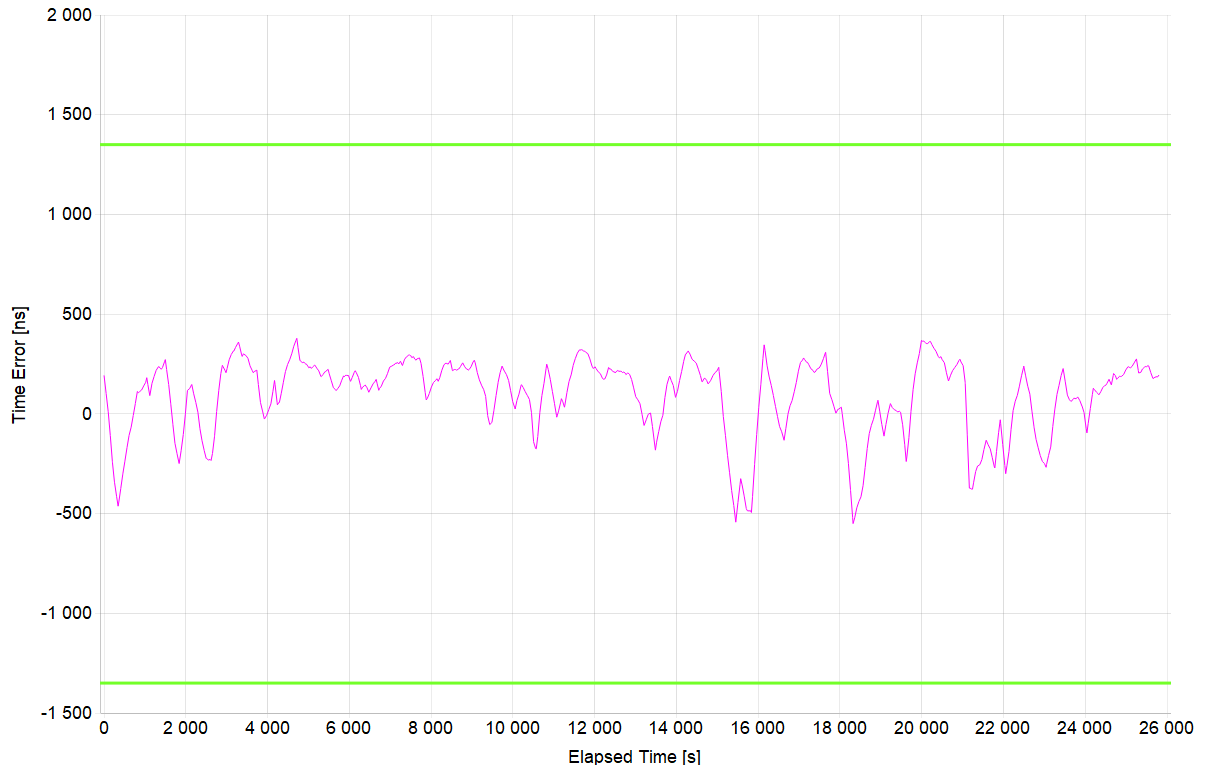

Mean [ns]	87.101
Min [ns]	-550.203
Max [ns]	378.797
Max-Min [ns]	929

12. G.8273.4 PTS: Noise Tolerance – No BC’s High Stability PDV

Test Description	Noise Tolerance – No BC’s High Stability PDV
Report Date	22-04-25_13-37-32
Packet Rate (pkt/s)	64
Test Duration	07:13:16
Time to Phase Lock (s)	63.0

All Mask Results	Pass
Mask ONEPPS	1.35µs
Mask ONEPPS Result	Pass

1. Data presented in the images below was collected using the following procedure:
 - Start PTP
 - Stabilize for 600s
 - Start PDV
 - Start Data Capture
2. This results in a short time to phase lock (see above table).Lock time under PDV conditions was measured to be 371s. The following procedure was used for locking under PDV conditions:
 - Start PDV
 - Start PTP
 - Start Data Capture

12.1 ONEPPS Analysis

Offset Removal Applied	Off
Zero Offset	1.677ns

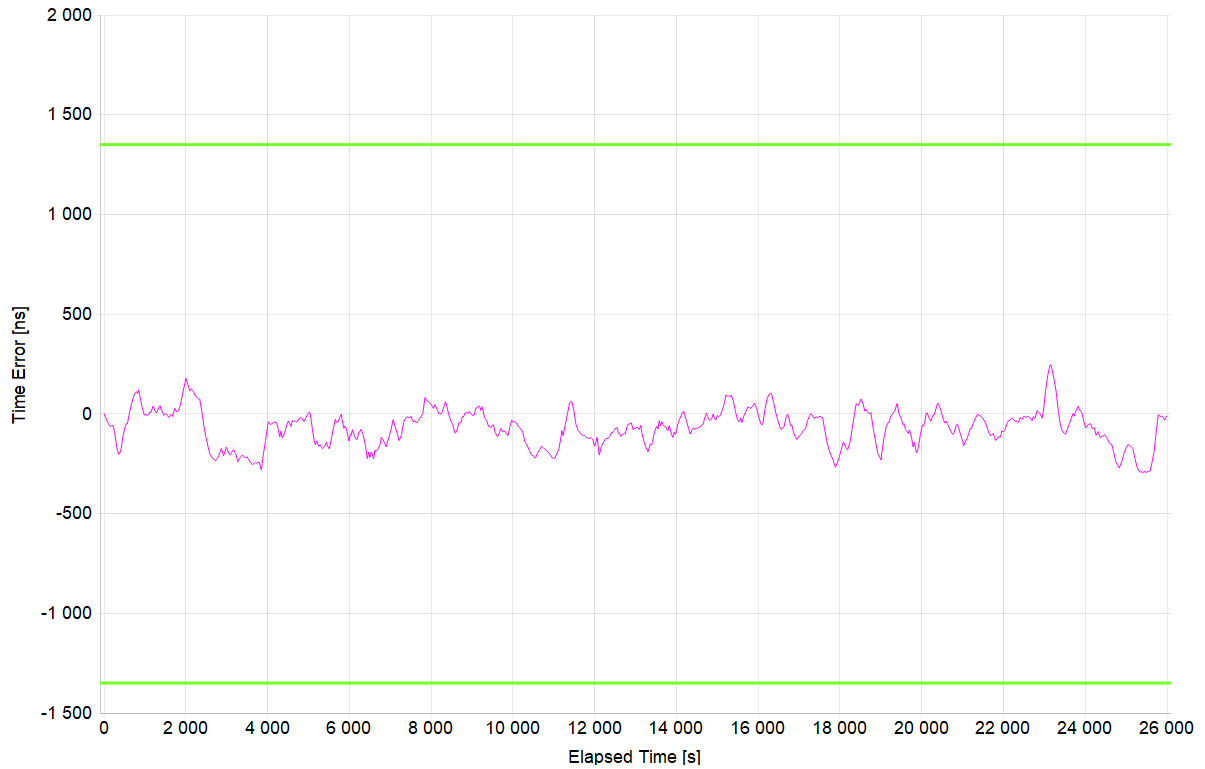

Mean [ns]	-69.767
Min [ns]	-296.323
Max [ns]	246.677
Max-Min [ns]	543

13. G.8273.4 PTS: Noise Tolerance – No BC’s Normal Stability PDV

Test Description	Noise Tolerance – No BC’s Normal Stability PDV
Report Date	22-04-25_13-37-32
Packet Rate (pkt/s)	64
Test Duration	08:03:17
Time to Phase Lock (s)	64.0

All Mask Results	Pass
Mask ONEPPS	1.35µs
Mask ONEPPS Result	Pass

3. Data presented in the images below was collected using the following procedure:
 - Start PTP
 - Stabilize for 600s
 - Start PDV
 - Start Data Capture
4. This results in a short time to phase lock (see above table).Lock time under PDV conditions was measured to be 412s. The following procedure was used for locking under PDV conditions:
 - Start PDV
 - Start PTP
 - Start Data Capture

13.1 ONEPPS Analysis

Offset Removal Applied	Off
Zero Offset	-24.073ns

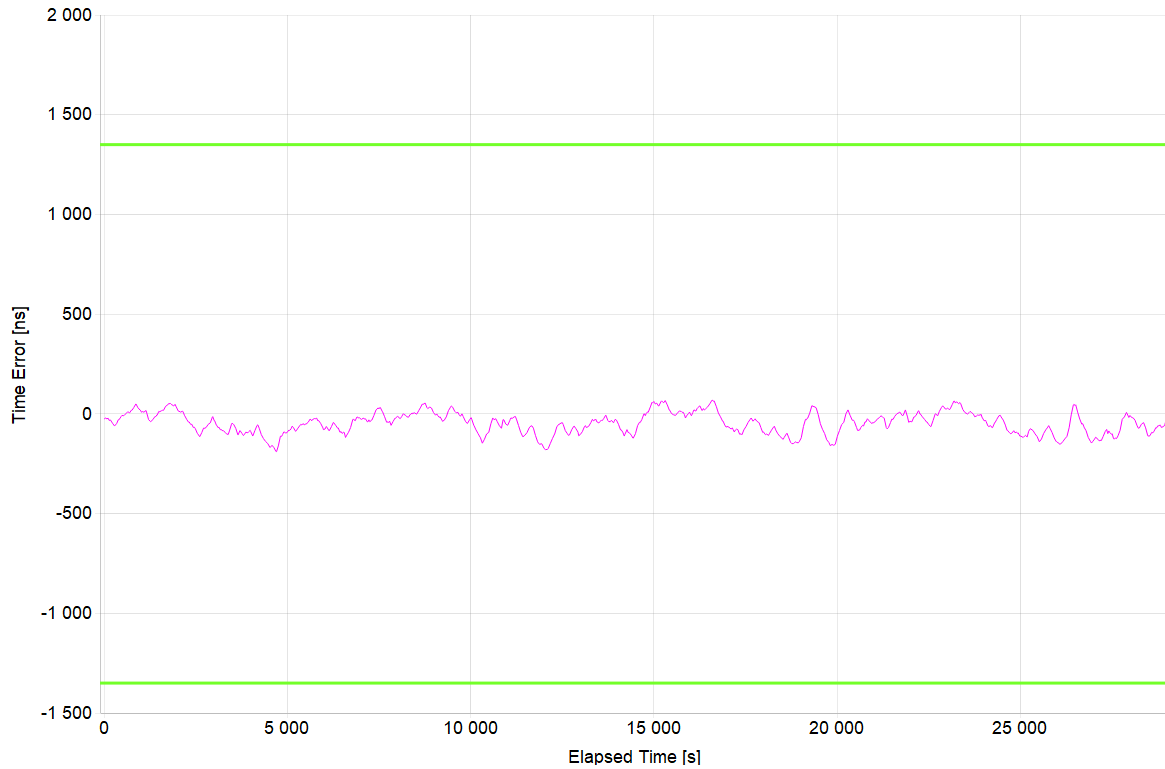

Mean [ns]	-47.392
Min [ns]	-189.323
Max [ns]	69.177
Max-Min [ns]	258.5

14. G.8273.4 PTS: Noise Tolerance – With BC’s High Stability PDV

Test Description	Noise Tolerance – With BC’s High Stability PDV
Report Date	22-04-25_13-37-32
Packet Rate (pkt/s)	64
Test Duration	06:06:38
Time to Phase Lock (s)	63.0

All Mask Results	Pass
Mask ONEPPS	1.35µs
Mask ONEPPS Result	Pass

1. Data presented in the images below was collected using the following procedure:
 - Start PTP
 - Stabilize for 600s
 - Start PDV
 - Start Data Capture
2. This results in a short time to phase lock (see above table).Lock time under PDV conditions was measured to be 372s. The following procedure was used for locking under PDV conditions:
 - Start PDV
 - Start PTP
 - Start Data Capture

14.1 ONEPPS Analysis

Offset Removal Applied	Off
Zero Offset	12.427ns

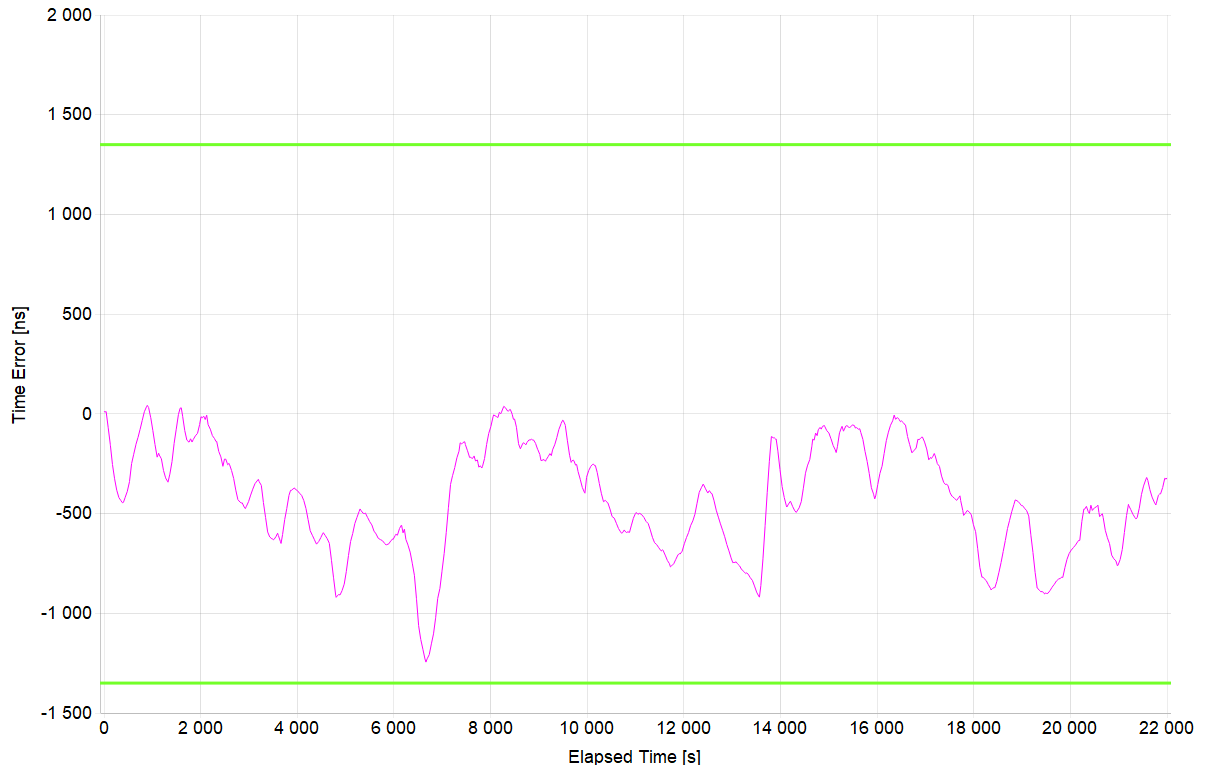

Mean [ns]	-427.269
Min [ns]	-1244.823
Max [ns]	42.677
Max-Min [ns]	1287.5

15. G.8273.4 PTS: Noise Tolerance – With BC’s Normal Stability PDV

Test Description	Noise Tolerance – With BC’s Normal Stability PDV
Report Date	22-04-25_13-37-32
Packet Rate (pkt/s)	64
Test Duration	06:06:37
Time to Phase Lock (s)	64.0

All Mask Results	Pass
Mask ONEPPS	1.35µs
Mask ONEPPS Result	Pass

1. Data presented in the images below was collected using the following procedure:
 - Start PTP
 - Stabilize for 600s
 - Start PDV
 - Start Data Capture
2. This results in a short time to phase lock (see above table).Lock time under PDV conditions was measured to be 422s. The following procedure was used for locking under PDV conditions:
 - Start PDV
 - Start PTP
 - Start Data Capture

15.1 ONEPPS Analysis

Offset Removal Applied	Off
Zero Offset	-14.573ns

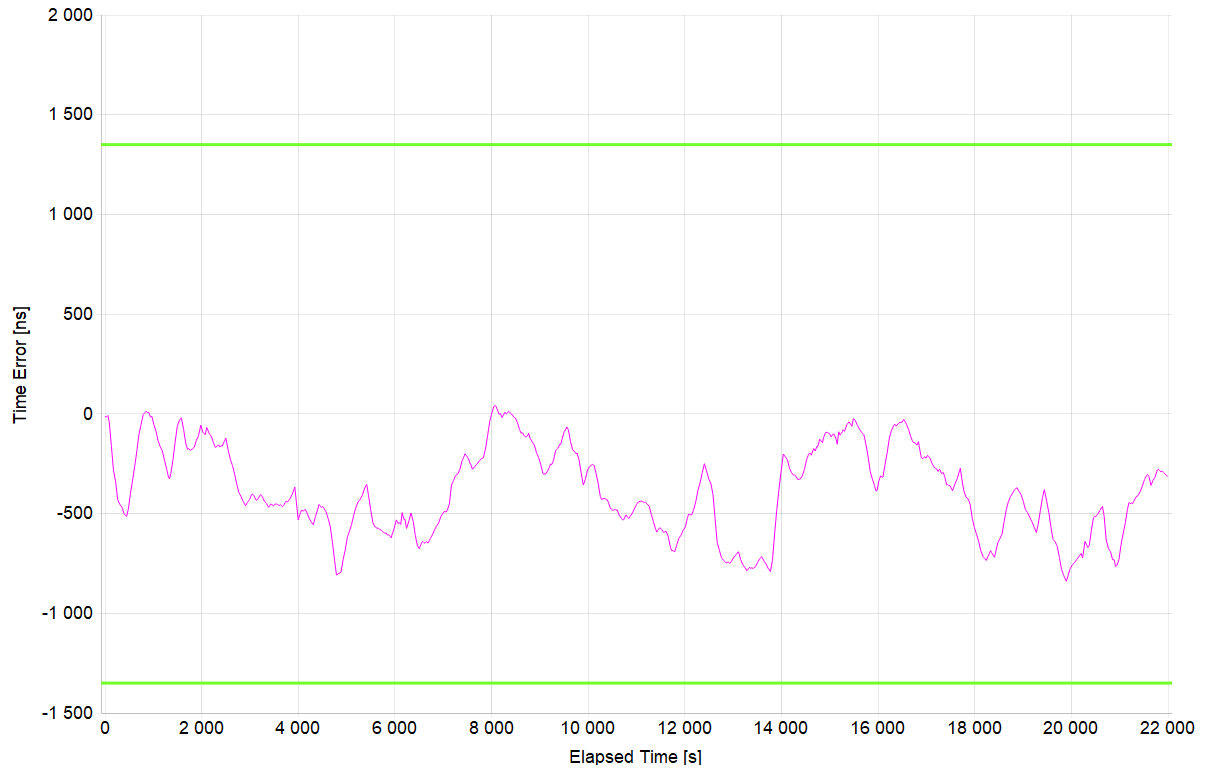

Mean [ns]	-387.691
Min [ns]	-839.823
Max [ns]	41.177
Max-Min [ns]	881

16. G.8273.4 PTS: Noise Tolerance – No BC’s High Stability PDV – SyncE Assistance

Test Description	Noise Tolerance – No BC’s High Stability PDV
Report Date	22-04-26_12-06-24
Packet Rate (pkt/s)	64
Test Duration	07:13:19
Test Configuration	2
Time to Phase Lock (s)	594

All Mask Results	Pass
Mask ONEPPS	1.35µs
Mask ONEPPS Result	Pass

16.1 ONEPPS Analysis

Offset Removal Applied	Off
Zero Offset	-46ns

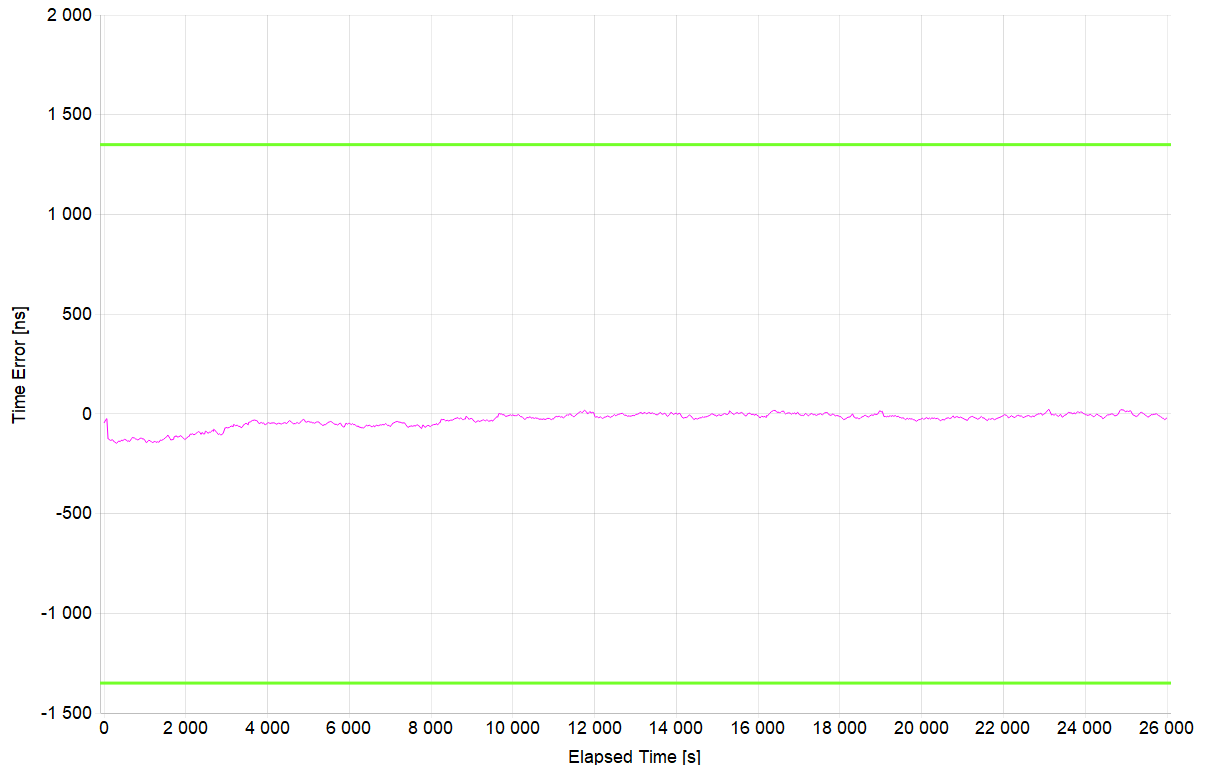

Mean [ns]	-30.952
Min [ns]	-148
Max [ns]	23
Max-Min [ns]	171

17. G.8273.4 PTS: Noise Tolerance – No BC’s Normal Stability PDV – SyncE Assistance

Test Description	Noise Tolerance – No BC’s Normal Stability PDV
Report Date	22-04-26_12-06-24
Packet Rate (pkt/s)	64
Test Duration	08:03:19
Test Configuration	2
Time to Phase Lock (s)	381

All Mask Results	Pass
Mask ONEPPS	1.35µs
Mask ONEPPS Result	Pass

17.1 ONEPPS Analysis

Offset Removal Applied	Off
Zero Offset	-6ns

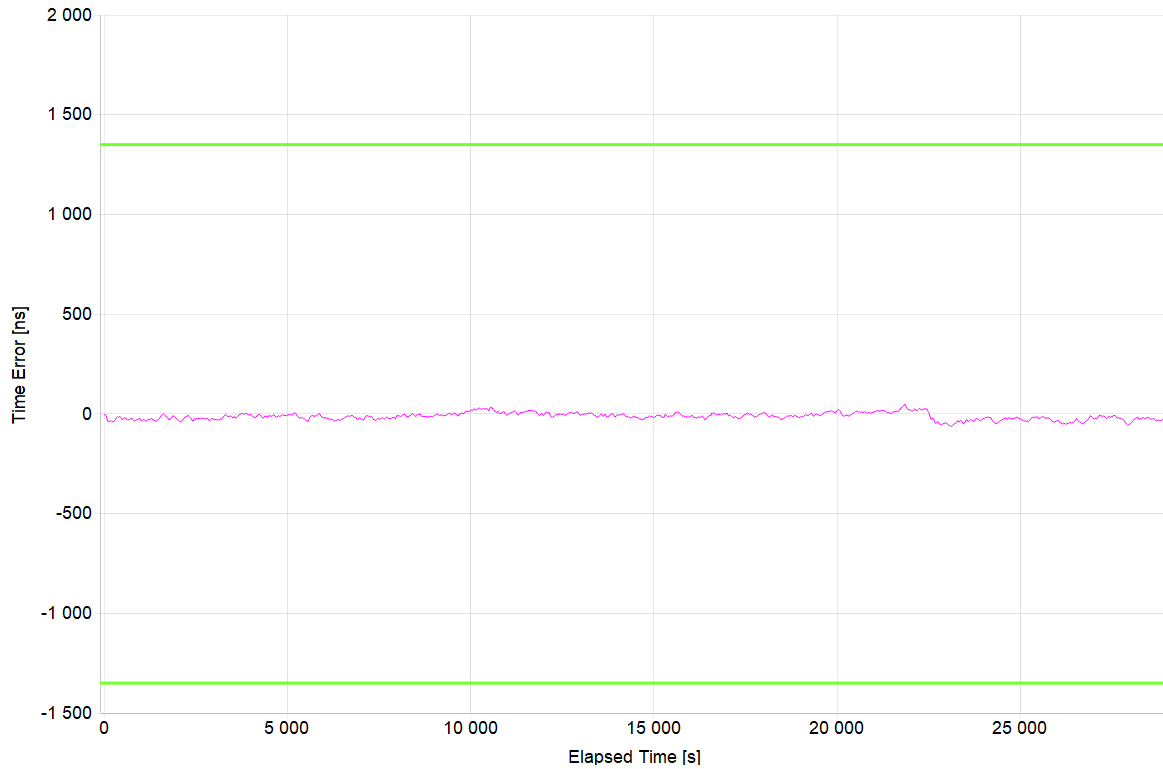

Mean [ns]	-12.877
Min [ns]	-63
Max [ns]	49
Max-Min [ns]	112

18. G.8273.4 PTS: Noise Tolerance – With BC’s High Stability PDV – SyncE Assistance

Test Description	Noise Tolerance – With BC’s High Stability PDV
Report Date	22-04-26_12-06-24
Packet Rate (pkt/s)	64
Test Duration	06:06:39
Test Configuration	2
Time to Phase Lock (s)	417

All Mask Results	Pass
Mask ONEPPS	1.35µs
Mask ONEPPS Result	Pass

18.1 ONEPPS Analysis

Offset Removal Applied	Off
Zero Offset	-61ns

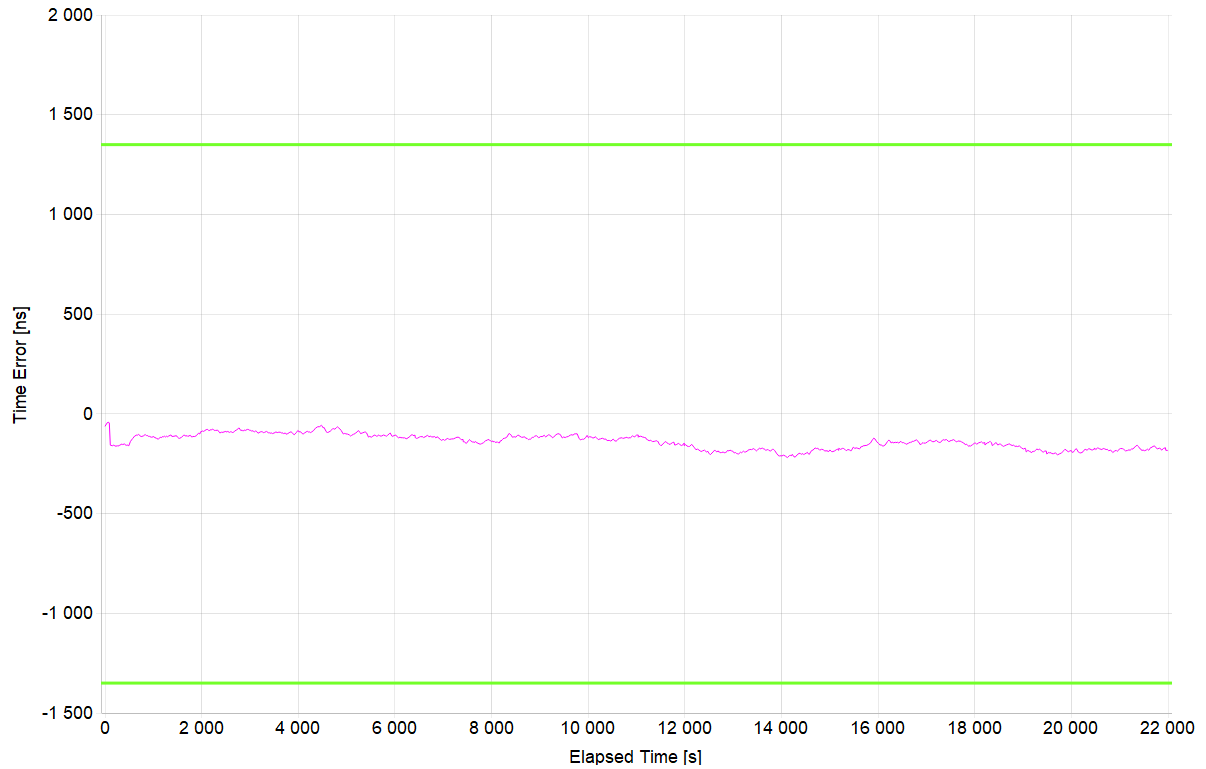

Mean [ns]	-139.432
Min [ns]	-219
Max [ns]	-42
Max-Min [ns]	177

19. G.8273.4 PTS: Noise Tolerance – With BC’s Normal Stability PDV – SyncE Assistance

Test Description	Noise Tolerance – With BC’s Normal Stability PDV
Report Date	22-04-26_12-06-24
Packet Rate (pkt/s)	16
Test Duration	06:06:39
Test Configuration	2
Time to Phase Lock (s)	418

All Mask Results	Pass
Mask ONEPPS	1.35µs
Mask ONEPPS Result	Pass

19.1 ONEPPS Analysis

Offset Removal Applied	Off
Zero Offset	-23ns

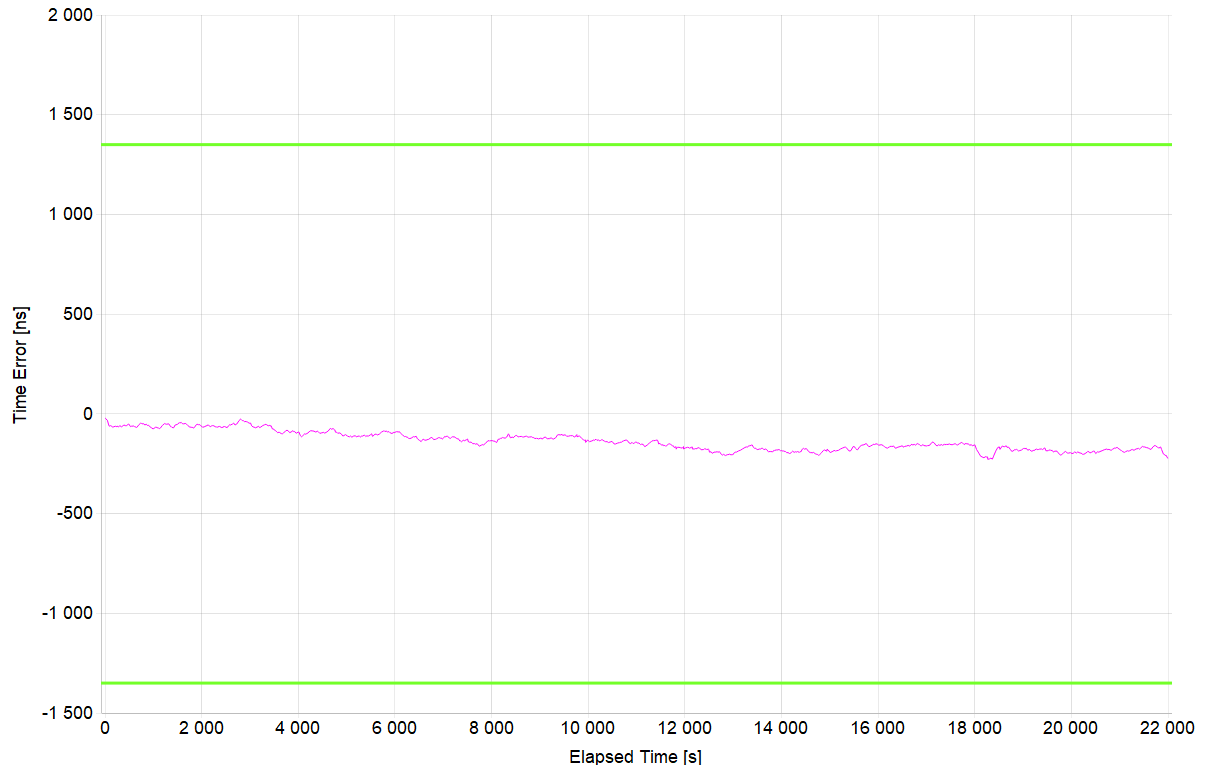

Mean [ns]	-136.881
Min [ns]	-228
Max [ns]	-22
Max-Min [ns]	206

20. G.8273.4 PTS: Noise Tolerance – No BC’s High Stability PDV – Single Path

Test Description	Noise Tolerance – No BC’s High Stability PDV
Report Date	22-04-26_09-52-35
Packet Rate (pkt/s)	64
Test Duration	06:39:59
Test Configuration	2
Time to Phase Lock (s)	982
Floor Delay Estimate (ns)	109730

All Mask Results	Pass
Mask ONEPPS	1.35µs
Mask ONEPPS Result	Pass

20.1 ONEPPS Analysis

Offset Removal Applied	Off
Zero Offset	138ns

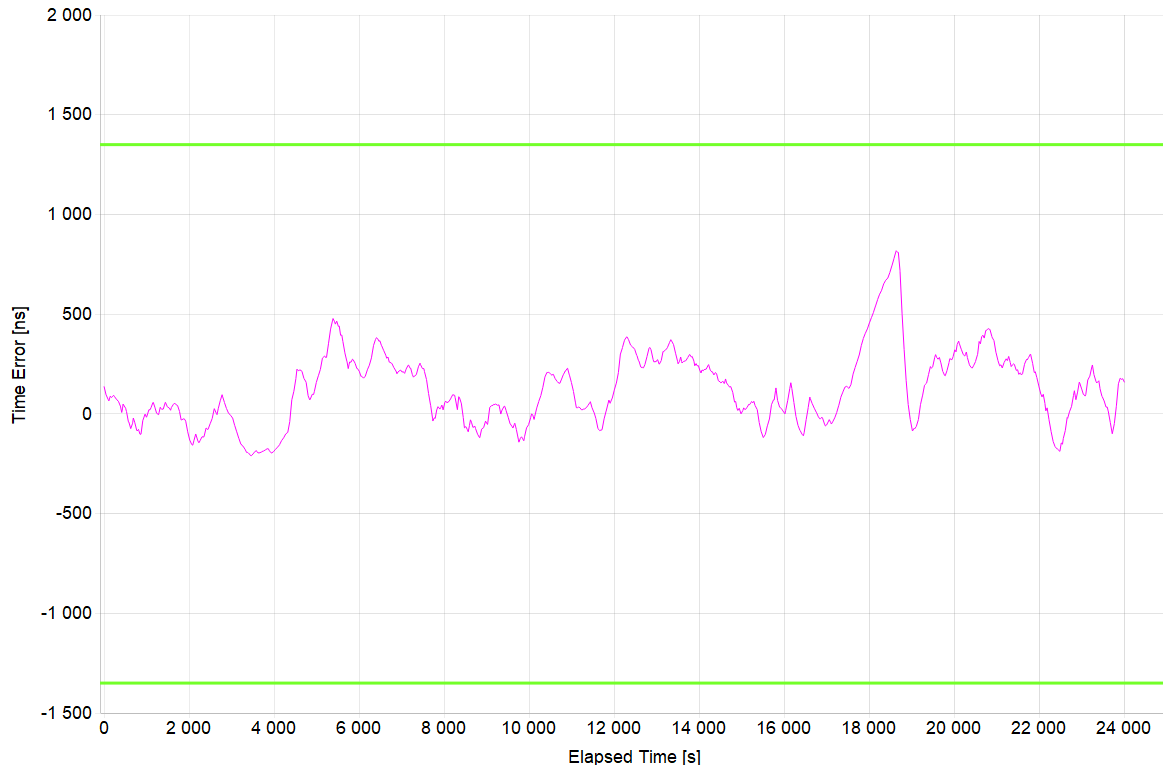

Mean [ns]	123.785
Min [ns]	-210
Max [ns]	818
Max-Min [ns]	1028

21. G.8273.4 PTS: Noise Tolerance – No BC’s Normal Stability PDV – Single Path

Test Description	Noise Tolerance – No BC’s Normal Stability PDV
Report Date	22-04-26_09-52-35
Packet Rate (pkt/s)	64
Test Duration	07:29:58
Test Configuration	2
Time to Phase Lock (s)	455
Floor Delay Estimate (ns)	51230

All Mask Results	Pass
Mask ONEPPS	1.35µs
Mask ONEPPS Result	Pass

21.1 ONEPPS Analysis

Offset Removal Applied	Off
Zero Offset	66ns

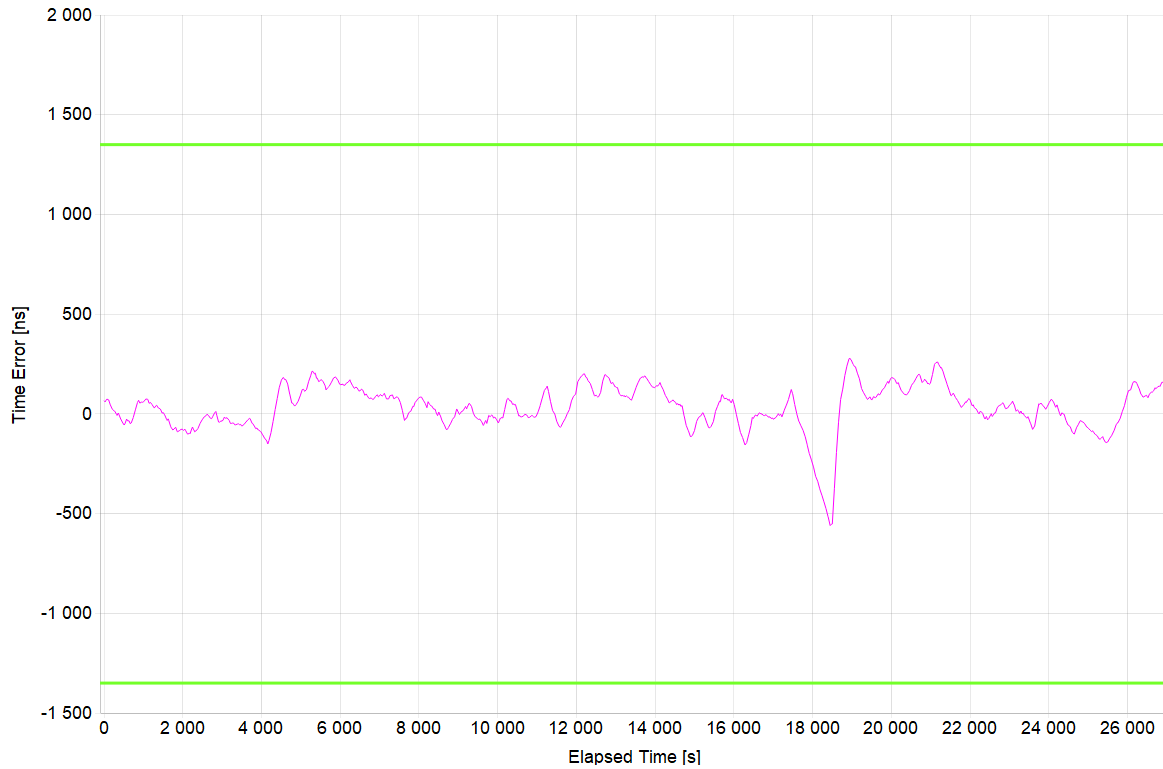

Mean [ns]	31.626
Min [ns]	-560
Max [ns]	280
Max-Min [ns]	840

22. Revision History

Revision	Date	Description
1.01	Jul 16, 2024	Replaced Xilinx with AMD throughout document.
1.00	May 3, 2023	Initial release.

IMPORTANT NOTICE AND DISCLAIMER

RENESAS ELECTRONICS CORPORATION AND ITS SUBSIDIARIES (“RENESAS”) PROVIDES TECHNICAL SPECIFICATIONS AND RELIABILITY DATA (INCLUDING DATASHEETS), DESIGN RESOURCES (INCLUDING REFERENCE DESIGNS), APPLICATION OR OTHER DESIGN ADVICE, WEB TOOLS, SAFETY INFORMATION, AND OTHER RESOURCES “AS IS” AND WITH ALL FAULTS, AND DISCLAIMS ALL WARRANTIES, EXPRESS OR IMPLIED, INCLUDING, WITHOUT LIMITATION, ANY IMPLIED WARRANTIES OF MERCHANTABILITY, FITNESS FOR A PARTICULAR PURPOSE, OR NON-INFRINGEMENT OF THIRD-PARTY INTELLECTUAL PROPERTY RIGHTS.

These resources are intended for developers who are designing with Renesas products. You are solely responsible for (1) selecting the appropriate products for your application, (2) designing, validating, and testing your application, and (3) ensuring your application meets applicable standards, and any other safety, security, or other requirements. These resources are subject to change without notice. Renesas grants you permission to use these resources only to develop an application that uses Renesas products. Other reproduction or use of these resources is strictly prohibited. No license is granted to any other Renesas intellectual property or to any third-party intellectual property. Renesas disclaims responsibility for, and you will fully indemnify Renesas and its representatives against, any claims, damages, costs, losses, or liabilities arising from your use of these resources. Renesas' products are provided only subject to Renesas' Terms and Conditions of Sale or other applicable terms agreed to in writing. No use of any Renesas resources expands or otherwise alters any applicable warranties or warranty disclaimers for these products.

(Disclaimer Rev.1.01)

Corporate Headquarters

TOYOSU FORESIA, 3-2-24 Toyosu,
Koto-ku, Tokyo 135-0061, Japan
www.renesas.com

Trademarks

Renesas and the Renesas logo are trademarks of Renesas Electronics Corporation. All trademarks and registered trademarks are the property of their respective owners.

Contact Information

For further information on a product, technology, the most up-to-date version of a document, or your nearest sales office, please visit www.renesas.com/contact-us/.