

Introduction

This report summarizes results of 1MeV equivalent neutron testing of the [ISL70002SEH](#) integrated FET point-of-load regulator. The test was conducted in order to determine the sensitivity of the part to Displacement Damage (DD) caused by neutron or proton environments. Neutron fluences ranged from $2 \times 10^{12} \text{ n/cm}^2$ to $1 \times 10^{14} \text{ n/cm}^2$. This project was carried out in collaboration with VPT, Inc. (Blacksburg, VA) and their support is gratefully acknowledged.

Related Literature

- For a full list of related documents, visit our website
 - [ISL70002SEH](#) product page
- MIL-STD-883 test method 1019

Part Description

The ISL70002SEH is a total dose and single-event effects hardened high-efficiency monolithic synchronous buck regulator with integrated (on-chip) switching MOSFETs. This single chip power solution operates across an input voltage range of 3V to 5.5V and provides a tightly regulated output voltage that is externally adjustable from 0.8V to ~85% of the input voltage. Output load current capacity is 12A for $T_J \leq +150^\circ \text{C}$. Two ISL70002SEH devices configured to current share can provide 19A total output current in what is effectively a two-phase converter. The ISL70002SEH uses peak current-mode control with integrated error amp compensation and pin selectable slope compensation. The switching frequency is pin selectable to either 500kHz or 1MHz.

The part features a comparator type enable input that can be used for simple digital on/off control or, alternately, can provide undervoltage lockout capability by sensing the magnitude of an external supply voltage using an external voltage divider. A power-good signal indicates when the output voltage is within $\pm 11\%$ (typical) of the nominal output voltage. The regulator start-up is controlled by an analog soft-start circuit externally adjustable from 2ms to 200ms. The ISL70002SEH fault protection features include input undervoltage, output undervoltage, and output overcurrent.

The ISL70002SEH has the option to operate two parts configured as a single two-phase regulator. This results in nearly twice the load current capacity and provides a complete power solution for large scale digital ICs, such as Field Programmable Gate Arrays (FPGAs), most of which require separate core and I/O voltages. In this mode, a redundant current sharing bus balances the load current between the two devices and communicates any fault conditions. In two-phase operation one part is designated the master circuit and the other the slave circuit and operation is controlled by the ISHSL pin, which is connected to DGND for master operation and to DVDD for slave operation. Refer also to the [ISL70002SEH](#)

datasheet for further diagrams and applications information. In two-phase operation, the two ISL70002SEH ICs run 180° out-of-phase to minimize the input ripple current, effectively operating as a single IC at twice the switching frequency. The master error amplifier and compensation network control the overall two phase regulator. From a single-event effects testing viewpoint, master and slave operation are functionally different, requiring separate SET and SEFI testing for each of the two conditions.

The ISL70002SEH is hardened to achieve a Total Dose (TID) rating of 100krads(Si) at both high (50-300rad(Si)/s) and low ($< 0.01 \text{ rad(Si)/s}$) dose rates as specified in MIL-STD-883 test method 1019. The part is acceptance tested on a wafer-by-wafer basis at low dose rate to 50krad(Si) and at high dose rate to 100krad(Si).

The ISL70002SEH is also Single Event Effects (SEE) tolerant to a Linear Energy Transfer (LET) value of $86.4 \text{ MeV} \cdot \text{cm}^2/\text{mg}$. Single-Event Transients (SET) have evolved into a major issue in power management parts driving voltage-sensitive loads. Additional SET hardening is achieved by specifying or restricting the values of certain external components.

The ISL70002SEH is implemented in a submicron BiCMOS process optimized for power management applications. The process is in volume production under MIL-PRF-38535 certification and is used for a wide range of commercial power management devices.

Specifications for radiation hardened QML devices are controlled by the Defense Logistics Agency (DLA) in Columbus, OH. The SMD is the controlling document and must be cited when ordering.

Block Diagram

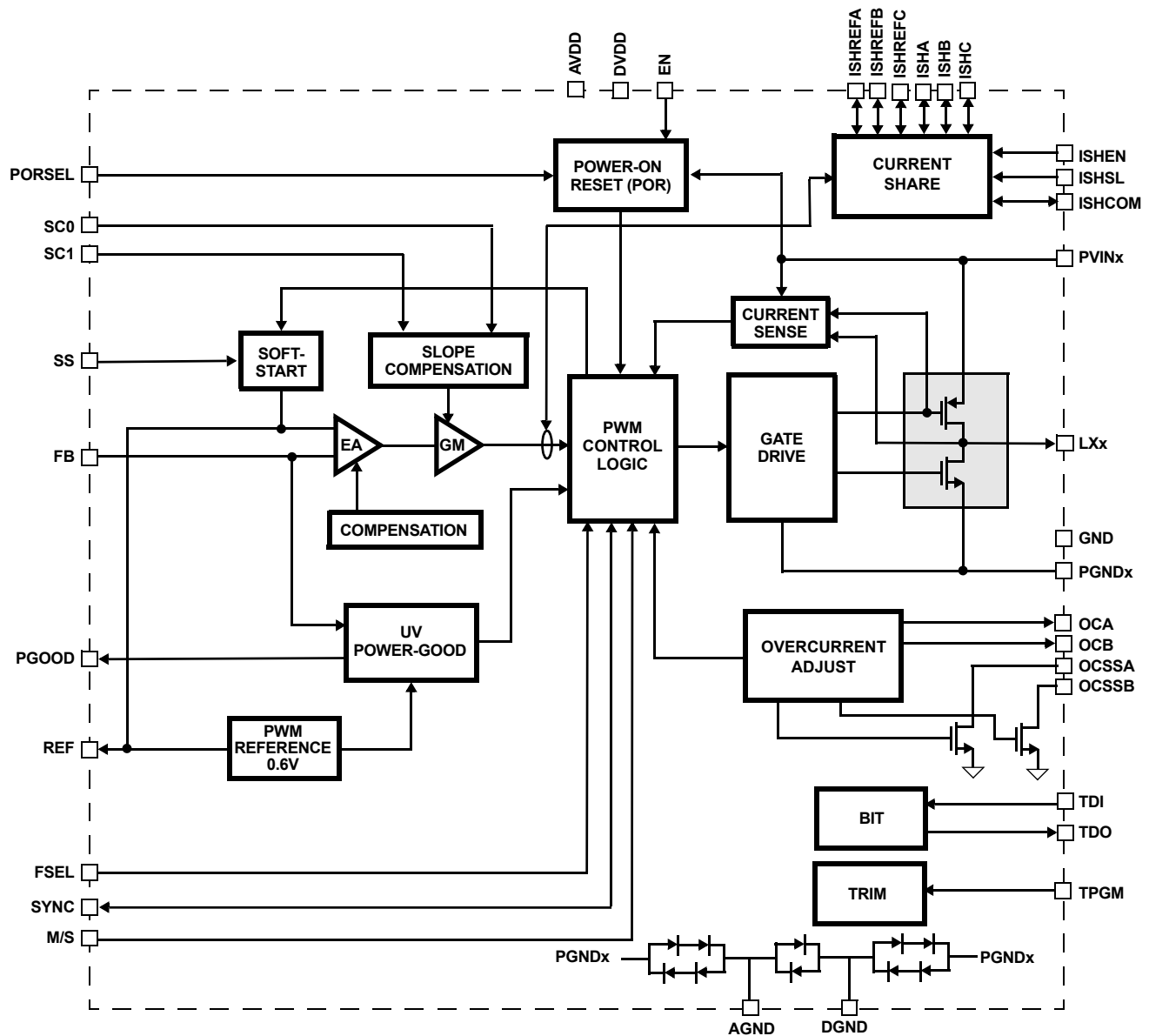

FIGURE 1. ISL70002SEH BLOCK DIAGRAM

Test Description

Irradiation Facilities

Neutron irradiation was performed by the VPT team at the University of Massachusetts Lowell Fast Neutron Irradiation (FNI) facility, which provides a controlled 1MeV equivalent neutron flux. Parts were tested in an unbiased configuration with all leads shorted together in accordance with TM 1017 of MIL-STD-883. As neutron irradiation activates many of the heavier elements found in a packaged integrated circuit, the samples exposed at the higher neutron levels required (as expected) 'cooldown' time before shipment back to Intersil (Palm Bay, FL) for electrical testing.

Test Fixturing

No formal irradiation test fixturing was involved, as these DD tests are 'bag tests', meaning that the parts are irradiated in an electrically inactive state with all leads shorted together.

Characterization Equipment and Procedures

Electrical testing was performed before and after irradiation using the Intersil production Automated Test Equipment (ATE). All electrical testing was performed at room temperature.

Experimental Matrix

Testing proceeded in general accordance with the guidelines of MIL-STD-883 Test Method 1017. The experimental matrix consisted of five samples irradiated at $2 \times 10^{12} \text{ n/cm}^2$, five samples irradiated at $1 \times 10^{13} \text{ n/cm}^2$, five samples irradiated at $3 \times 10^{13} \text{ n/cm}^2$, and five samples irradiated at $1 \times 10^{14} \text{ n/cm}^2$. Two control units (serial numbers 68 and 70) were used.

The ISL70002SEHF/PROTO samples were drawn from Lot WTTA0AA. Samples were packaged in the standard hermetic 64 Ld pin Ceramic Quad Flatpack (CQFP) production package, code R64.A. Samples were screened to the SMD limits over-temperature before the start of neutron testing.

Results

Neutron testing of the ISL70002SEH is complete and the results are reported in the balance of this report. It should be carefully realized when interpreting the data that each neutron irradiation was performed on a different five-unit sample; this is *not* total dose testing, where the damage is cumulative over a number of downpoints.

Attributes Data

TABLE 1. ATTRIBUTES DATA

PART	FLUENCE, n/cm^2	SAMPLE SIZE	PASS (Note 1)	FAIL
ISL70002SEH	2×10^{12}	5	5	0
ISL70002SEH	1×10^{13}	5	0	5
ISL70002SEH	3×10^{13}	5	0	5
ISL70002SEH	1×10^{14}	5	0	5

NOTE:

1. "Pass" indicates a sample that passes all SMD limits.

Variables Data

The plots in Figures 2 through 44 show data plots for key parameters before and after irradiation to each level. The plots show the median of each parameter as a function of neutron irradiation. We chose to plot the median because of the small sample sizes (five per cell) involved. We also show the applicable electrical limits taken from the SMD; it should be carefully noted that these limits are provided for *guidance only* because the ISL70002SEH is not specified or guaranteed for the neutron environment. Intersil does not design, qualify, or guarantee its parts for the DD environment; however, it has performed some limited neutron testing for customer guidance.

Variables Data Plots

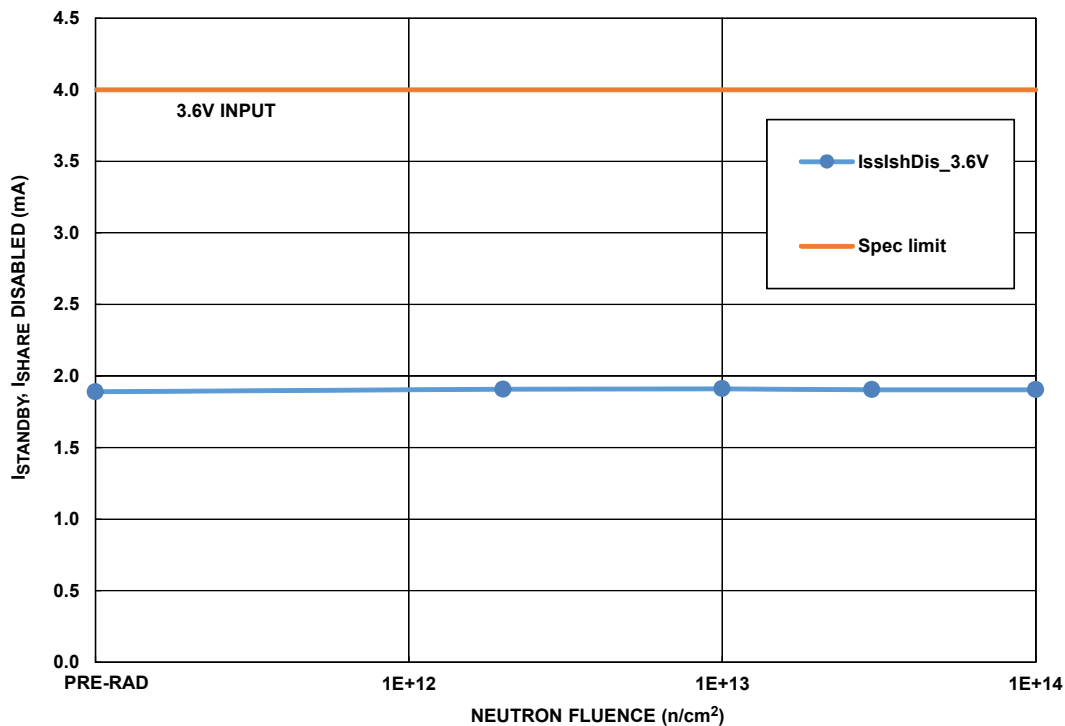

FIGURE 2. ISL70002SEH standby supply current, current share disabled, input voltage of 3.6V, as a function of 1MeV equivalent neutron irradiation at $2 \times 10^{12} \text{ n/cm}^2$, $1 \times 10^{13} \text{ n/cm}^2$, $3 \times 10^{13} \text{ n/cm}^2$, and $1 \times 10^{14} \text{ n/cm}^2$. Sample size for each cell was five. The post total dose irradiation SMD limit is 4.0mA maximum.

Variables Data Plots (Continued)

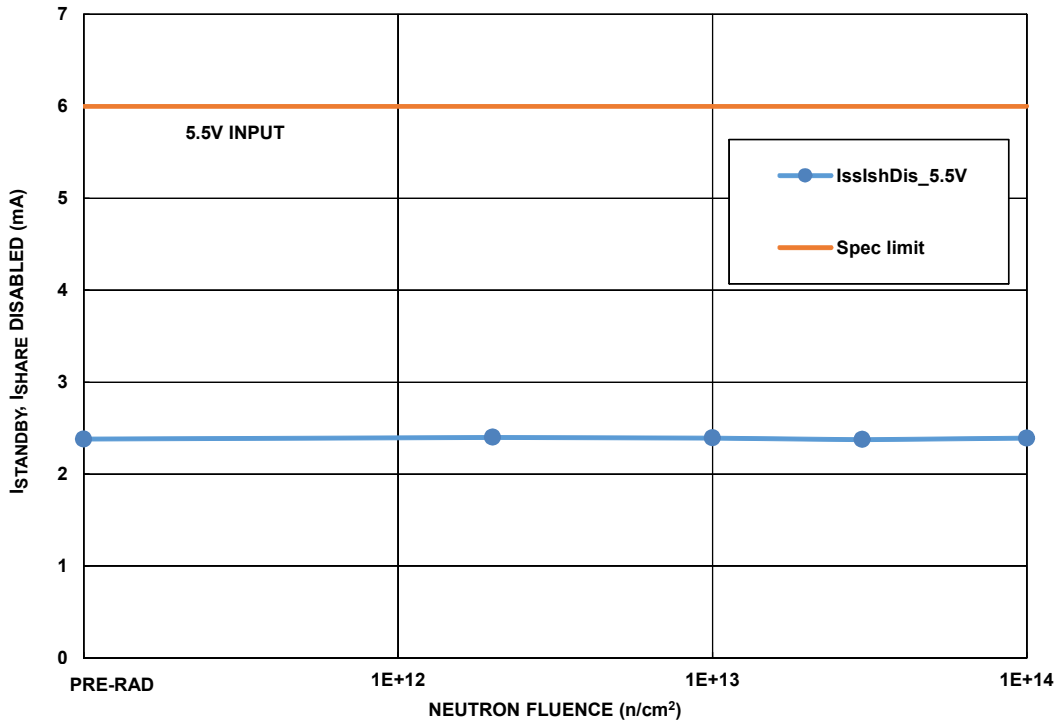

FIGURE 3. ISL70002SEH standby supply current, current share disabled, input voltage of 5.5V, as a function of 1MeV equivalent neutron irradiation at $2 \times 10^{12} \text{ n/cm}^2$, $1 \times 10^{13} \text{ n/cm}^2$, $3 \times 10^{13} \text{ n/cm}^2$ and $1 \times 10^{14} \text{ n/cm}^2$. Sample size for each cell was five. The post total dose irradiation SMD limit is 6.0mA maximum.

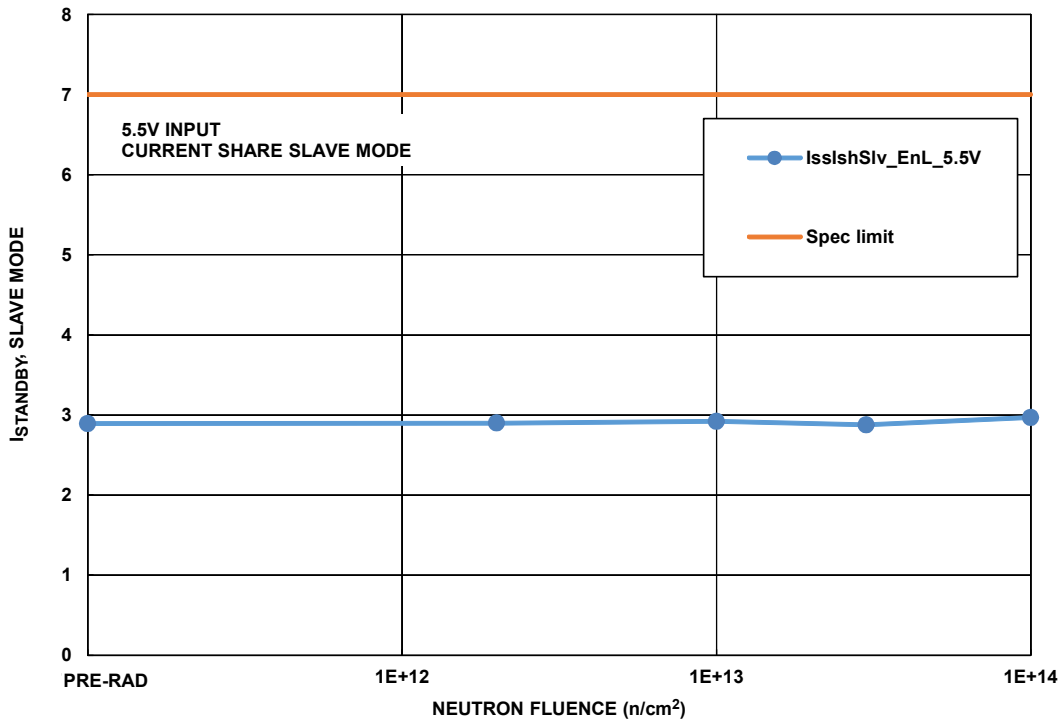

FIGURE 4. ISL70002SEH standby supply current, current share enabled in SLAVE mode, EN = M/S = GND, input voltage of 5.5V, as a function of 1MeV equivalent neutron irradiation at $2 \times 10^{12} \text{ n/cm}^2$, $1 \times 10^{13} \text{ n/cm}^2$, $3 \times 10^{13} \text{ n/cm}^2$, and $1 \times 10^{14} \text{ n/cm}^2$. Sample size for each cell was five. The post total dose irradiation SMD limit is 7.0mA maximum.

Variables Data Plots (Continued)

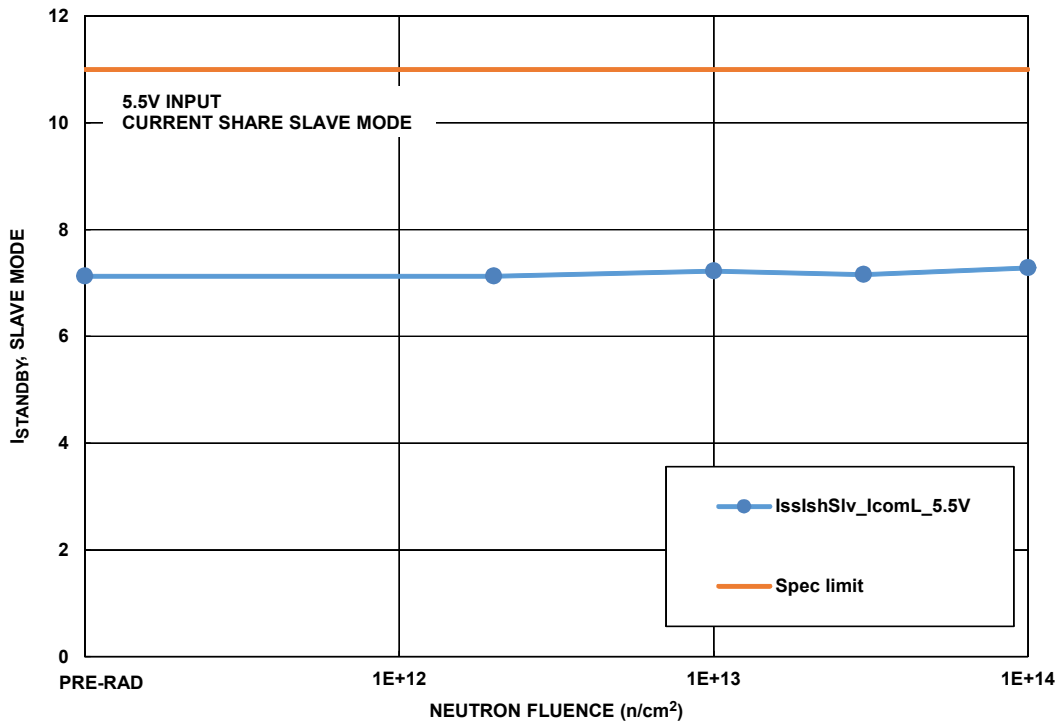

FIGURE 5. ISL70002SEH standby supply current, current share enabled in SLAVE mode, M/S = GND, ISHCOM = GND, input voltage of 5.5V, as a function of 1MeV equivalent neutron irradiation at $2 \times 10^{12} \text{ n/cm}^2$, $1 \times 10^{13} \text{ n/cm}^2$, $3 \times 10^{13} \text{ n/cm}^2$, and $1 \times 10^{14} \text{ n/cm}^2$. Sample size for each cell was five. The post total dose irradiation SMD limit is 11.0mA maximum.

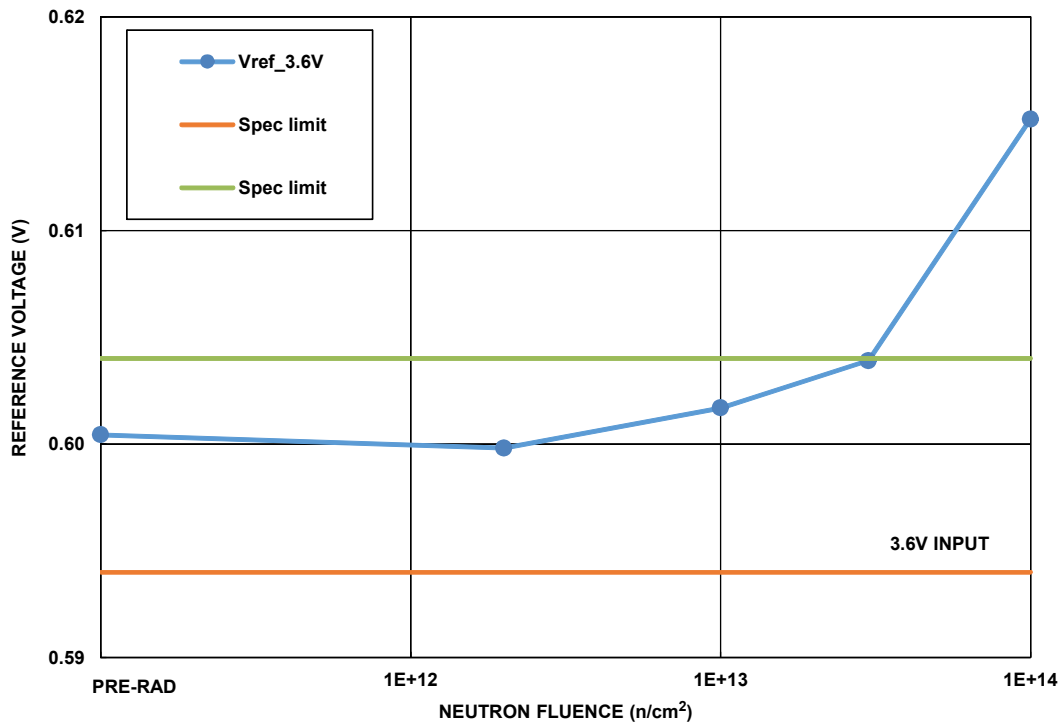

FIGURE 6. ISL70002SEH reference voltage at an input voltage of 3.6V as a function of 1MeV equivalent neutron irradiation at $2 \times 10^{12} \text{ n/cm}^2$, $1 \times 10^{13} \text{ n/cm}^2$, $3 \times 10^{13} \text{ n/cm}^2$, and $1 \times 10^{14} \text{ n/cm}^2$. Sample size for each cell was five. The post total dose irradiation SMD limits are 0.594V to 0.604V.

Variables Data Plots (Continued)

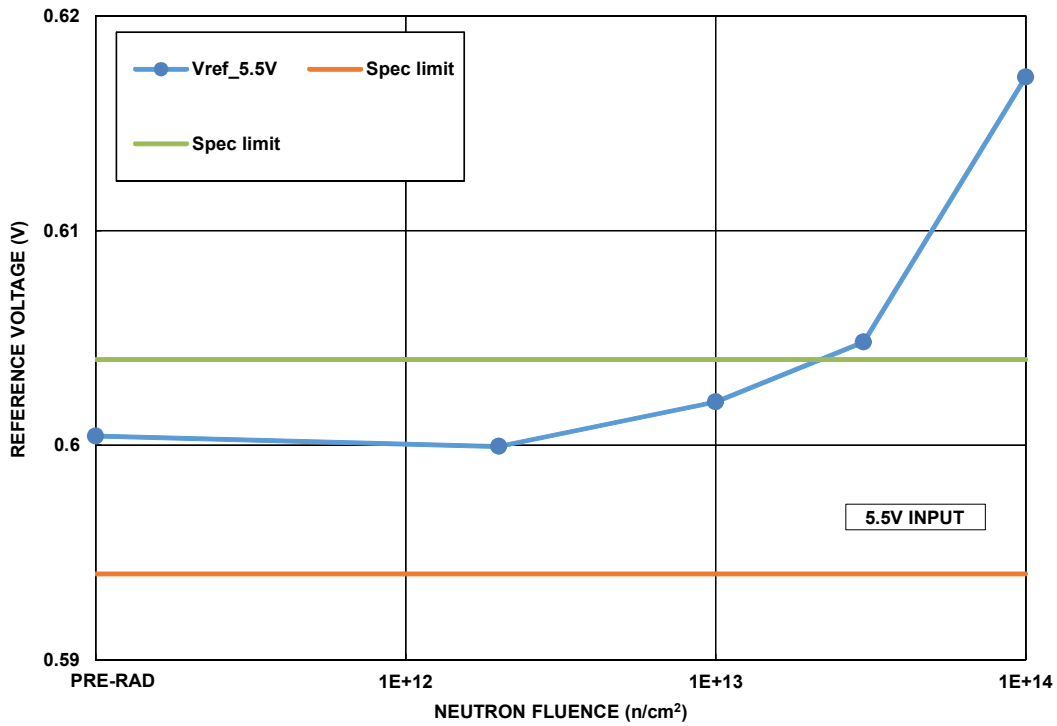

FIGURE 7. ISL70002SEH reference voltage at an input voltage of 5.5V as a function of 1MeV equivalent neutron irradiation at $2 \times 10^{12} \text{ n/cm}^2$, $1 \times 10^{13} \text{ n/cm}^2$, $3 \times 10^{13} \text{ n/cm}^2$, and $1 \times 10^{14} \text{ n/cm}^2$. Sample size for each cell was five. The post total dose irradiation SMD limits are 0.594V to 0.604V.

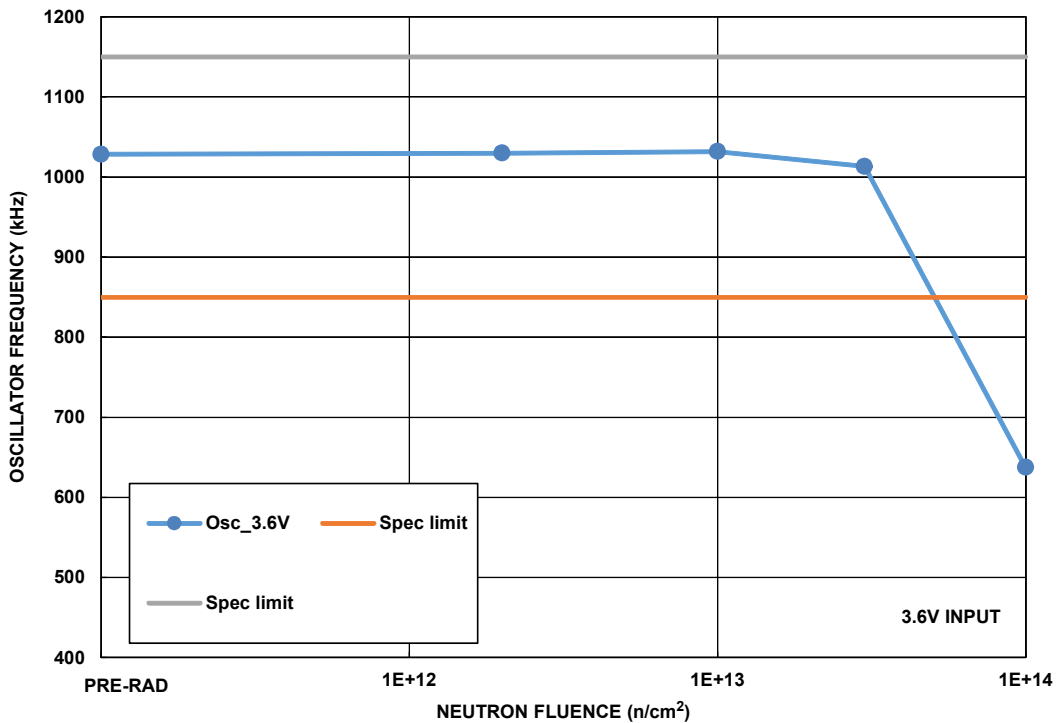

FIGURE 8. ISL70002SEH internal oscillator frequency at an input voltage of 3.6V as a function of 1MeV equivalent neutron irradiation at $2 \times 10^{12} \text{ n/cm}^2$, $1 \times 10^{13} \text{ n/cm}^2$, $3 \times 10^{13} \text{ n/cm}^2$, and $1 \times 10^{14} \text{ n/cm}^2$. Sample size for each cell was five. The post total dose irradiation SMD limits are 850kHz to 1150kHz.

Variables Data Plots (Continued)

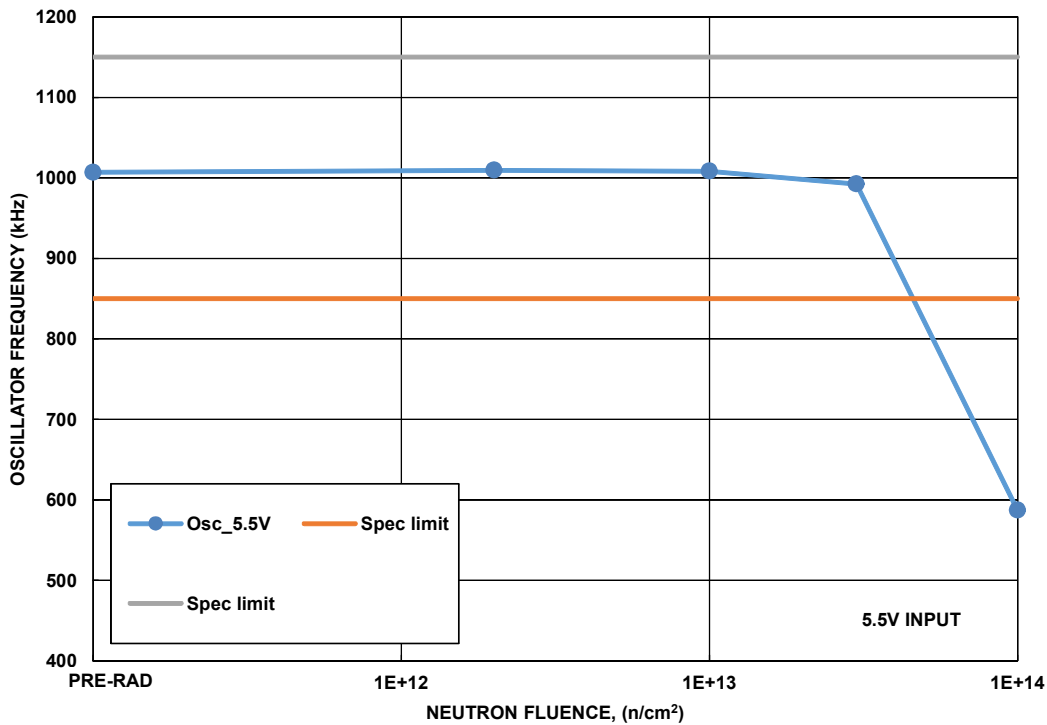

FIGURE 9. ISL70002SEH internal oscillator frequency at an input voltage of 5.5V as a function of 1MeV equivalent neutron irradiation at $2 \times 10^{12} \text{ n/cm}^2$, $1 \times 10^{13} \text{ n/cm}^2$, $3 \times 10^{13} \text{ n/cm}^2$, and $1 \times 10^{14} \text{ n/cm}^2$. Sample size for each cell was five. The post total dose irradiation SMD limits are 850kHz to 1150kHz.

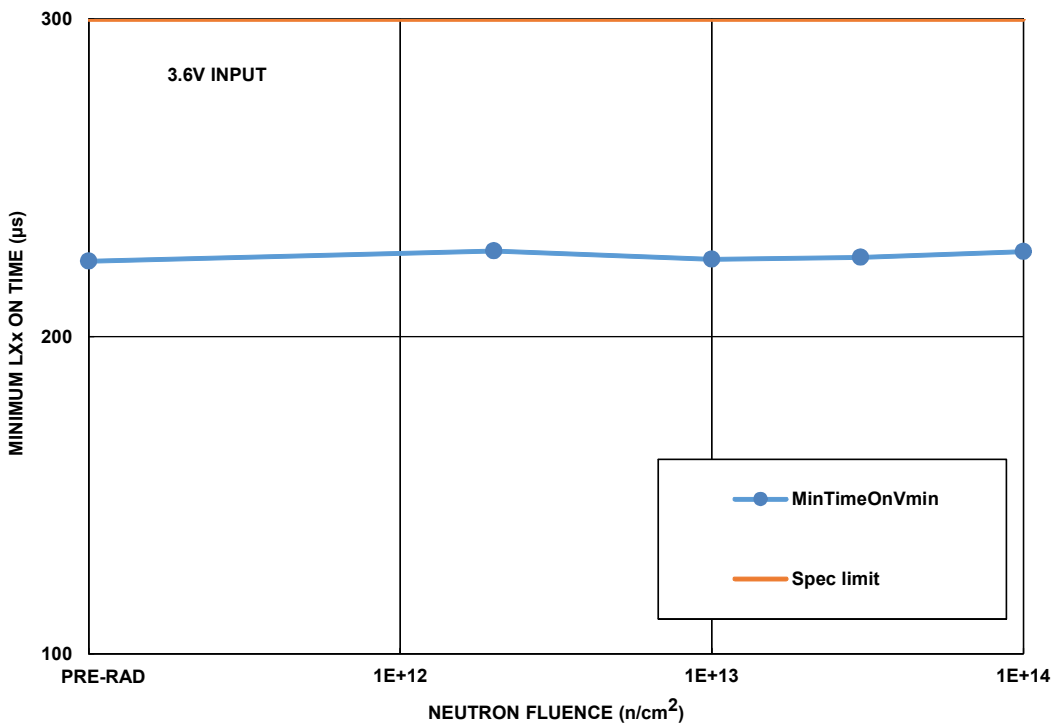

FIGURE 10. ISL70002SEH minimum LXx ON time at an input voltage of 3.6V as a function of 1MeV equivalent neutron irradiation at $2 \times 10^{12} \text{ n/cm}^2$, $1 \times 10^{13} \text{ n/cm}^2$, $3 \times 10^{13} \text{ n/cm}^2$, and $1 \times 10^{14} \text{ n/cm}^2$. Sample size for each cell was five. The post total dose irradiation SMD limit is 300.0ns maximum.

Variables Data Plots (Continued)

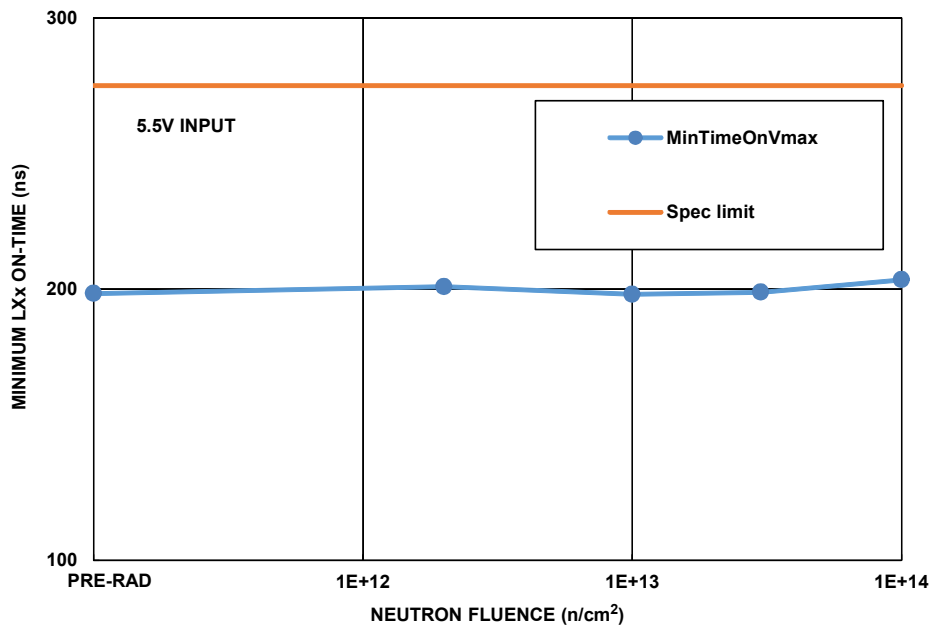

FIGURE 11. ISL70002SEH minimum LXx ON-time at an input voltage of 5.5V as a function of 1MeV equivalent neutron irradiation at $2 \times 10^{12} \text{ n/cm}^2$, $1 \times 10^{13} \text{ n/cm}^2$, $3 \times 10^{13} \text{ n/cm}^2$, and $1 \times 10^{14} \text{ n/cm}^2$. Sample size for each cell was five. The post total dose irradiation SMD limit is 275.0ns maximum.

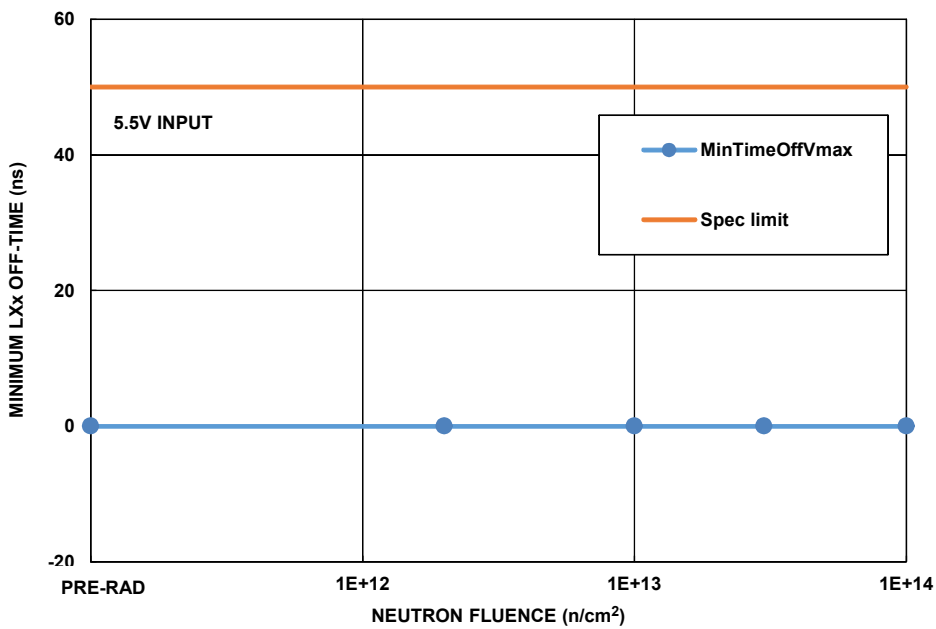

FIGURE 12. ISL70002SEH minimum LXx OFF-time at an input voltage of 5.5V as a function of 1MeV equivalent neutron irradiation at $2 \times 10^{12} \text{ n/cm}^2$, $1 \times 10^{13} \text{ n/cm}^2$, $3 \times 10^{13} \text{ n/cm}^2$, and $1 \times 10^{14} \text{ n/cm}^2$. Sample size for each cell was five. The post total dose irradiation SMD limit is 50.0ns maximum.

Variables Data Plots (Continued)

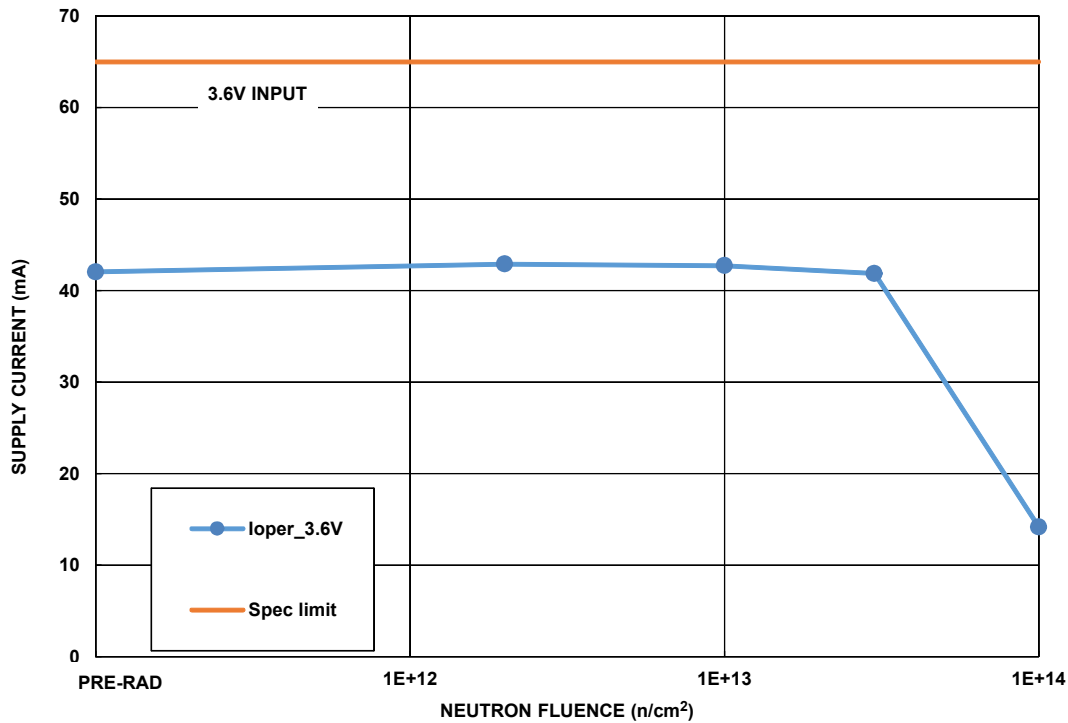

FIGURE 13. ISL70002SEH operating supply current at an input voltage of 3.6V as a function of 1MeV equivalent neutron irradiation at $2 \times 10^{12} \text{ n/cm}^2$, $1 \times 10^{13} \text{ n/cm}^2$, $3 \times 10^{13} \text{ n/cm}^2$, and $1 \times 10^{14} \text{ n/cm}^2$. Sample size for each cell was five. The post total dose irradiation SMD limit is 65.0mA maximum.

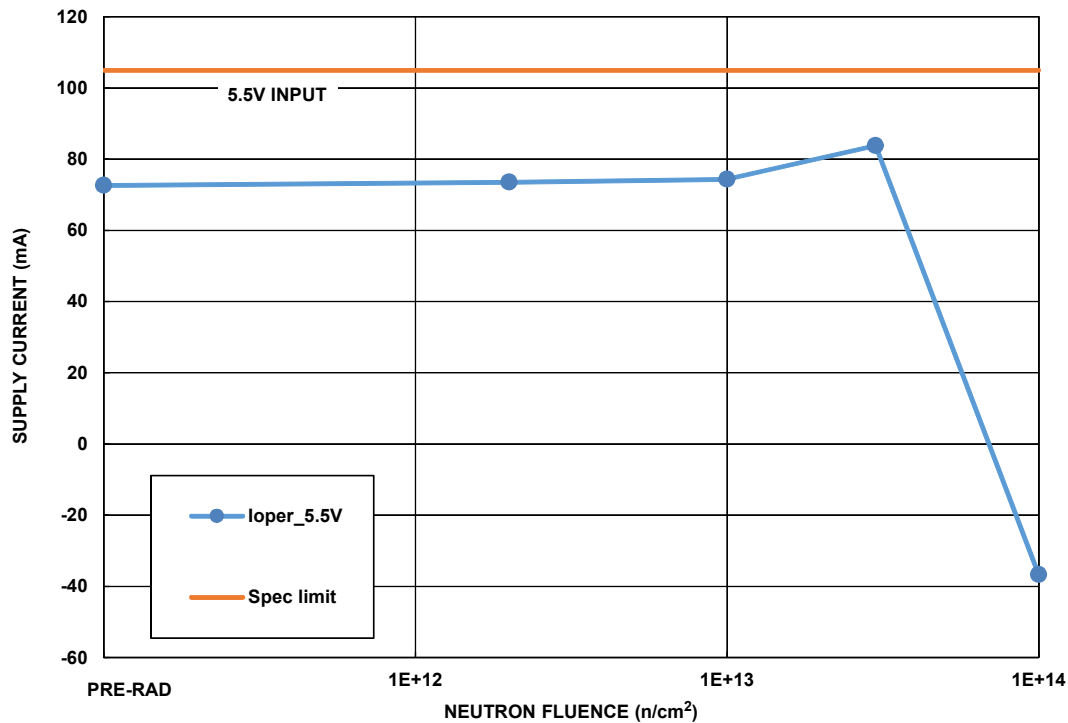

FIGURE 14. ISL70002SEH operating supply current at an input voltage of 5.5V as a function of 1MeV equivalent neutron irradiation at $2 \times 10^{12} \text{ n/cm}^2$, $1 \times 10^{13} \text{ n/cm}^2$, $3 \times 10^{13} \text{ n/cm}^2$, and $1 \times 10^{14} \text{ n/cm}^2$. Sample size for each cell was five. The post total dose irradiation SMD limit is 105.0mA maximum.

Variables Data Plots (Continued)

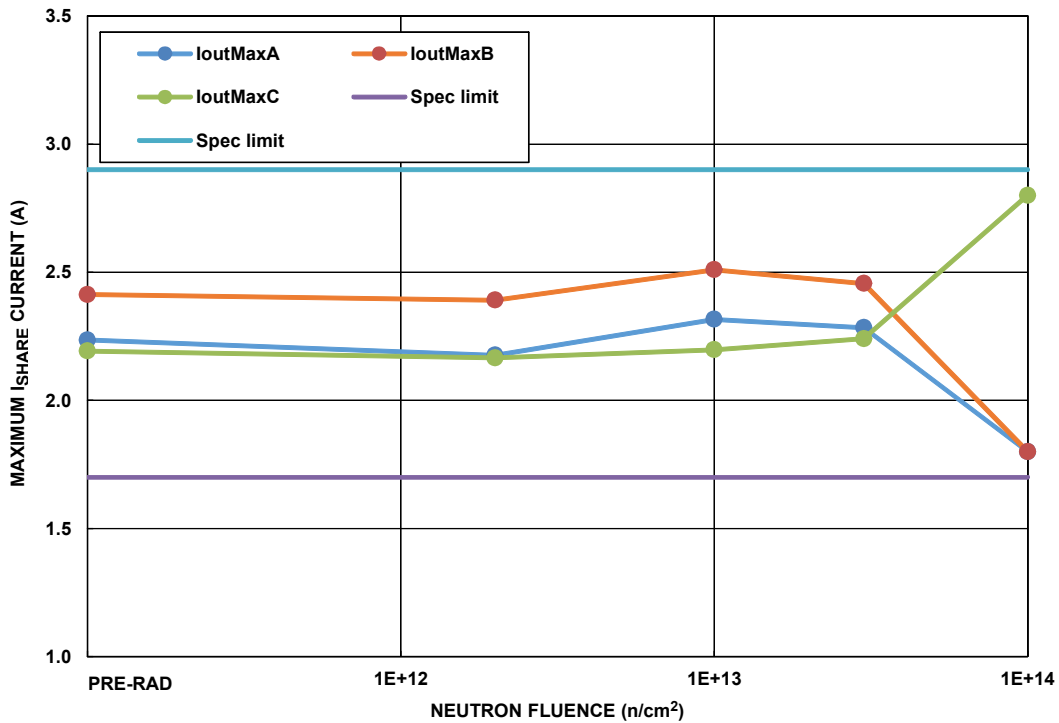

FIGURE 15. ISL70002SEH maximum current share (A, B, and C) output current as a function of 1MeV equivalent neutron irradiation at $2 \times 10^{12} \text{ n/cm}^2$, $1 \times 10^{13} \text{ n/cm}^2$, $3 \times 10^{13} \text{ n/cm}^2$, and $1 \times 10^{14} \text{ n/cm}^2$. Sample size for each cell was five. This is an informational parameter and is not specified in the SMD.

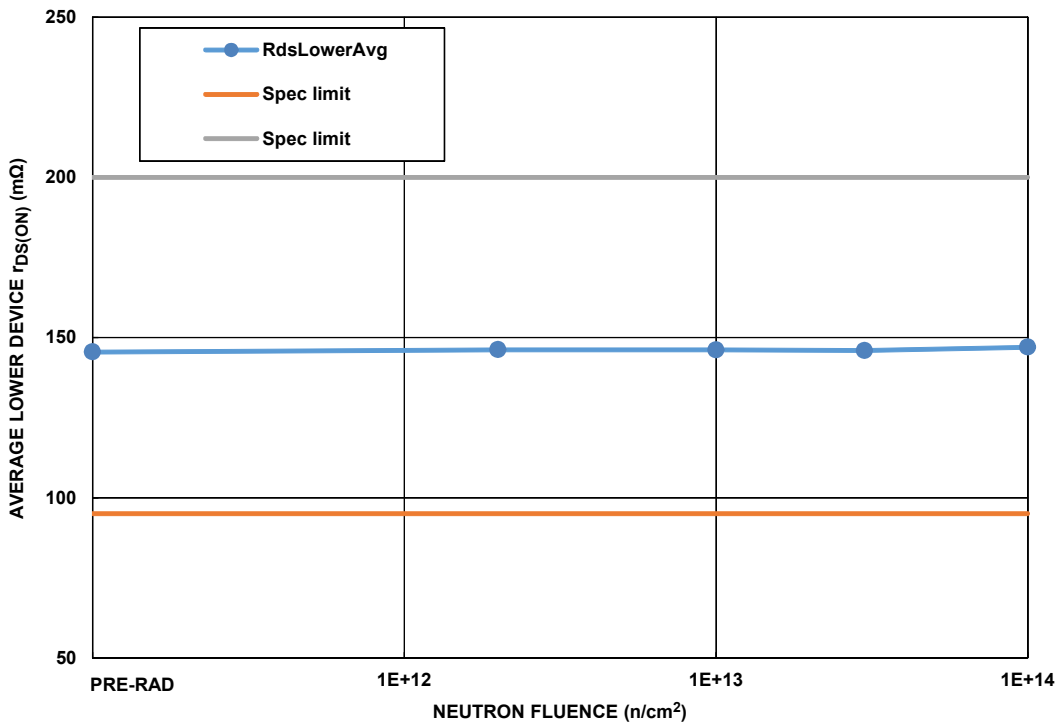

FIGURE 16. ISL70002SEH average lower power transistor drain-to-source ON-resistance as a function of 1MeV equivalent neutron irradiation at $2 \times 10^{12} \text{ n/cm}^2$, $1 \times 10^{13} \text{ n/cm}^2$, $3 \times 10^{13} \text{ n/cm}^2$, and $1 \times 10^{14} \text{ n/cm}^2$. Sample size for each cell was five. This is an informational parameter and is not specified in the SMD.

Variables Data Plots (Continued)

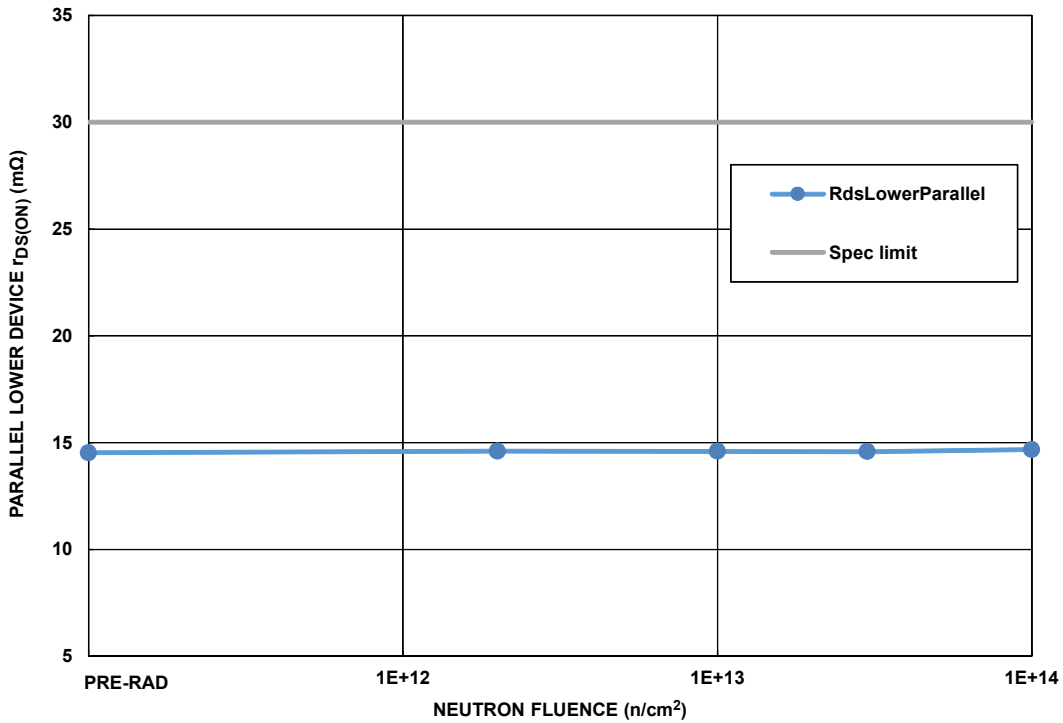

FIGURE 17. ISL70002SEH lower power transistor drain-to-source ON-resistance, all ten blocks in parallel, as a function of 1MeV equivalent neutron irradiation at $2 \times 10^{12} n/cm^2$, $1 \times 10^{13} n/cm^2$, $3 \times 10^{13} n/cm^2$, and $1 \times 10^{14} n/cm^2$. Sample size for each cell was five. The post total dose irradiation SMD limit is 30.0m Ω maximum.

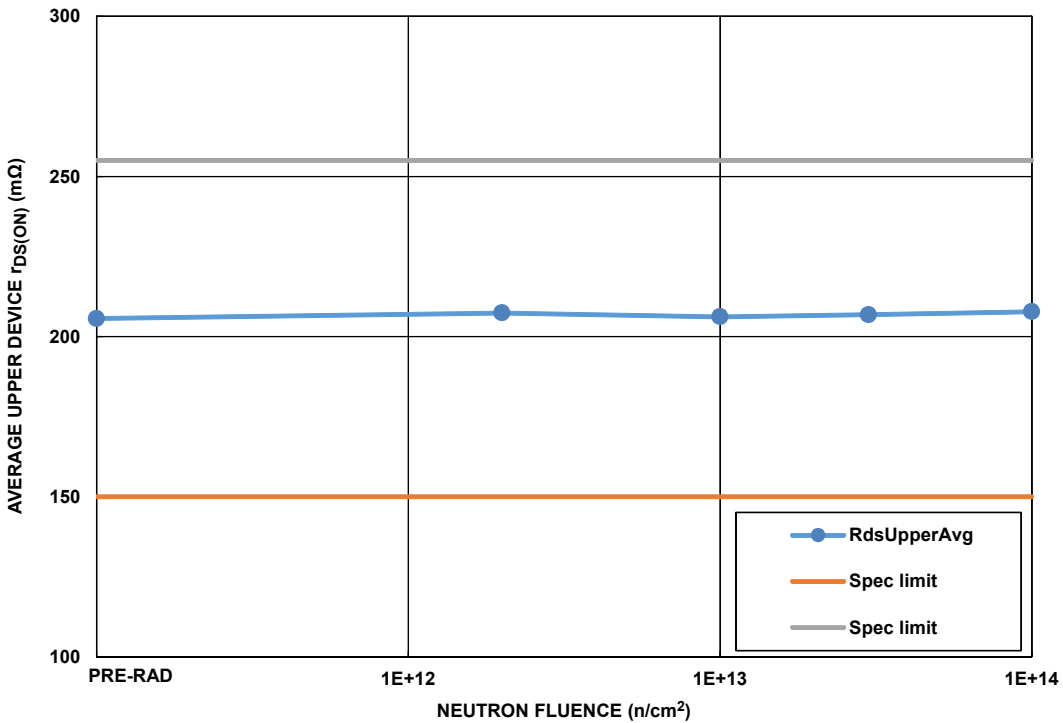

FIGURE 18. ISL70002SEH average upper power transistor drain-to-source ON-resistance as a function of 1MeV equivalent neutron irradiation at $2 \times 10^{12} n/cm^2$, $1 \times 10^{13} n/cm^2$, $3 \times 10^{13} n/cm^2$, and $1 \times 10^{14} n/cm^2$. Sample size for each cell was five. This is an informational parameter and is not specified in the SMD.

Variables Data Plots (Continued)

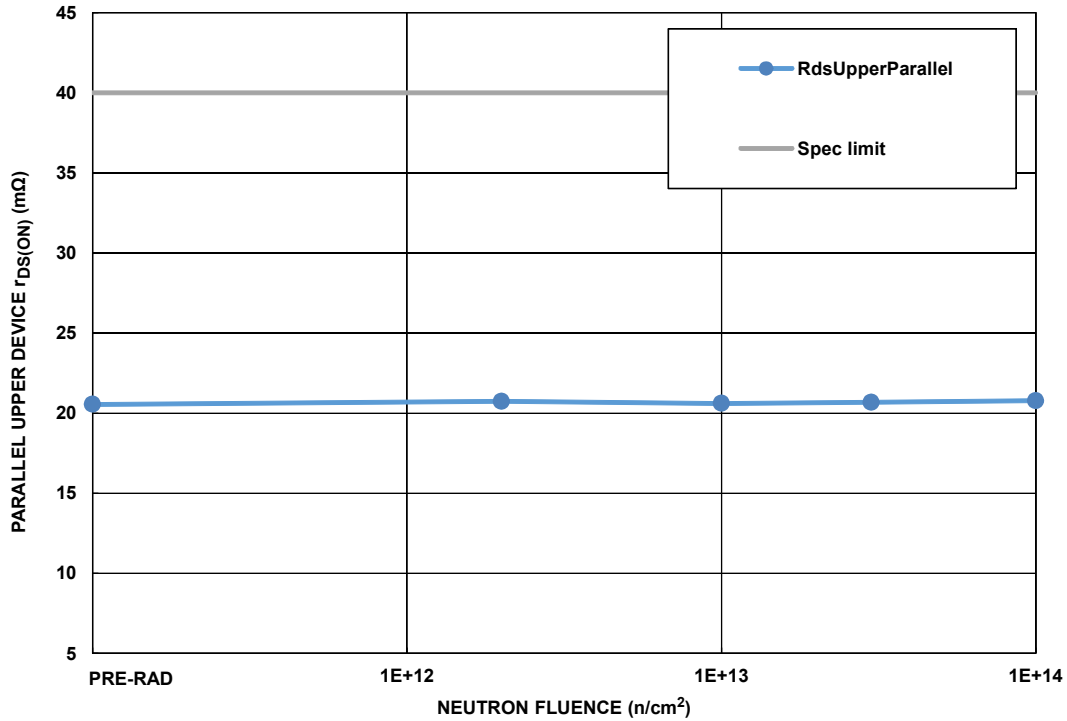

FIGURE 19. ISL70002SEH upper power transistor drain-to-source ON-resistance, all ten blocks in parallel, as a function of 1MeV equivalent neutron irradiation at $2 \times 10^{12} \text{ n/cm}^2$, $1 \times 10^{13} \text{ n/cm}^2$, $3 \times 10^{13} \text{ n/cm}^2$, and $1 \times 10^{14} \text{ n/cm}^2$. Sample size for each cell was five. The post total dose irradiation SMD limit is 40mΩ maximum.

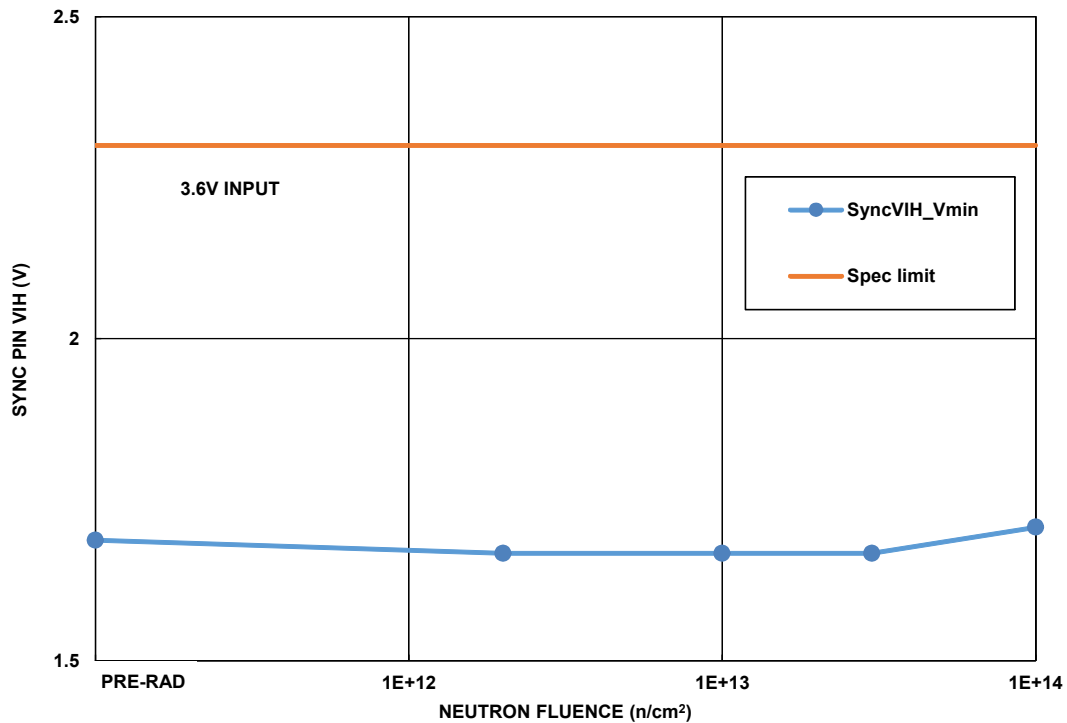

FIGURE 20. ISL70002SEH SYNC pin HIGH threshold, input voltage of 3.6V, as a function of 1MeV equivalent neutron irradiation at $2 \times 10^{12} \text{ n/cm}^2$, $1 \times 10^{13} \text{ n/cm}^2$, $3 \times 10^{13} \text{ n/cm}^2$, and $1 \times 10^{14} \text{ n/cm}^2$. Sample size for each cell was five. The post total dose irradiation SMD limit is 2.3V minimum to be applied for the input to be considered high.

Variables Data Plots (Continued)

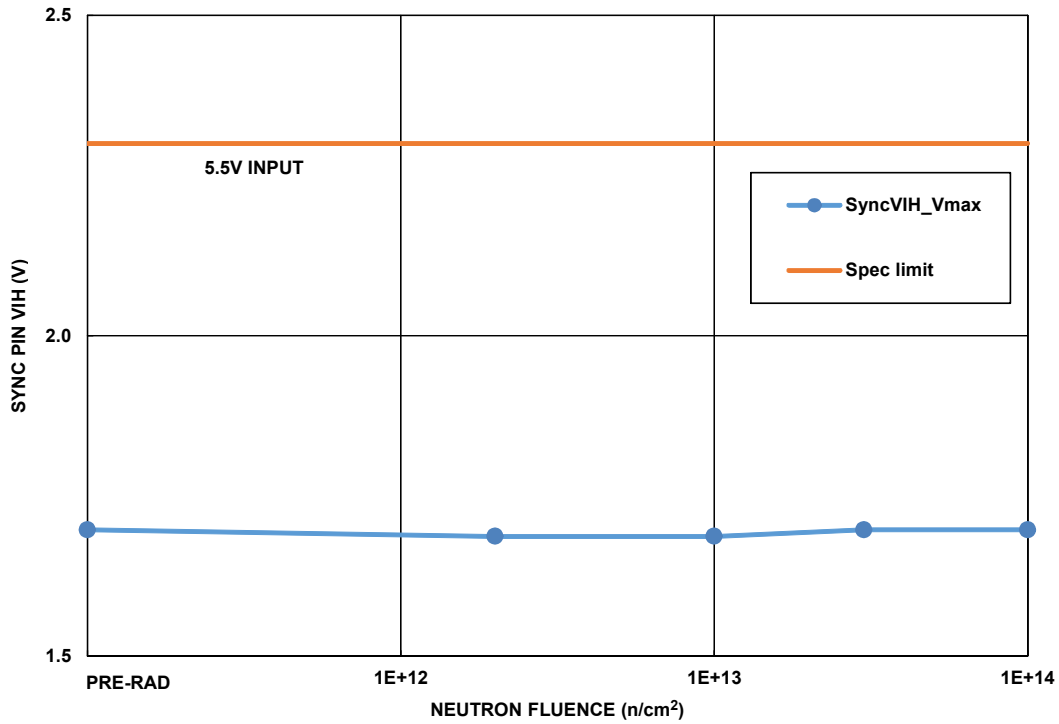

FIGURE 21. ISL70002SEH SYNC pin HIGH threshold, input voltage of 5.5V, as a function of 1MeV equivalent neutron irradiation at $2 \times 10^{12} \text{ n/cm}^2$, $1 \times 10^{13} \text{ n/cm}^2$, $3 \times 10^{13} \text{ n/cm}^2$, and $1 \times 10^{14} \text{ n/cm}^2$. Sample size for each cell was five. The post total dose irradiation SMD limit is 2.3V minimum to be applied for the input to be considered high.

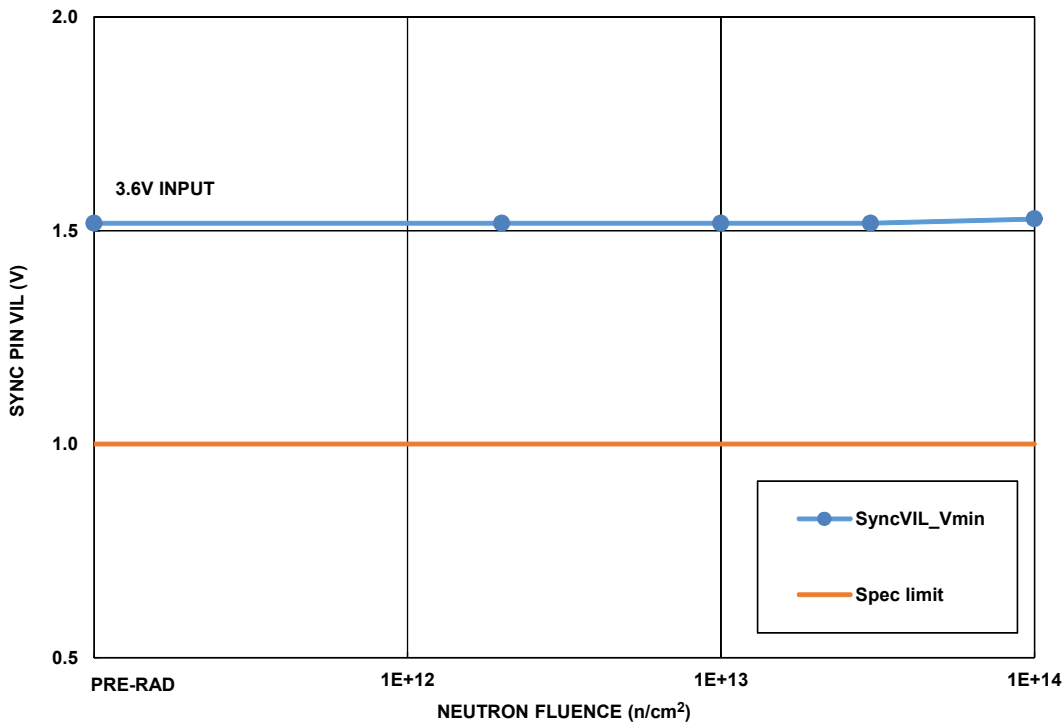

FIGURE 22. ISL70002SEH SYNC pin LOW threshold, input voltage of 3.6V, as a function of 1MeV equivalent neutron irradiation at $2 \times 10^{12} \text{ n/cm}^2$, $1 \times 10^{13} \text{ n/cm}^2$, $3 \times 10^{13} \text{ n/cm}^2$, and $1 \times 10^{14} \text{ n/cm}^2$. Sample size for each cell was five. The post total dose irradiation SMD limit is 1.0V maximum to be applied for the input to be considered low.

Variables Data Plots (Continued)

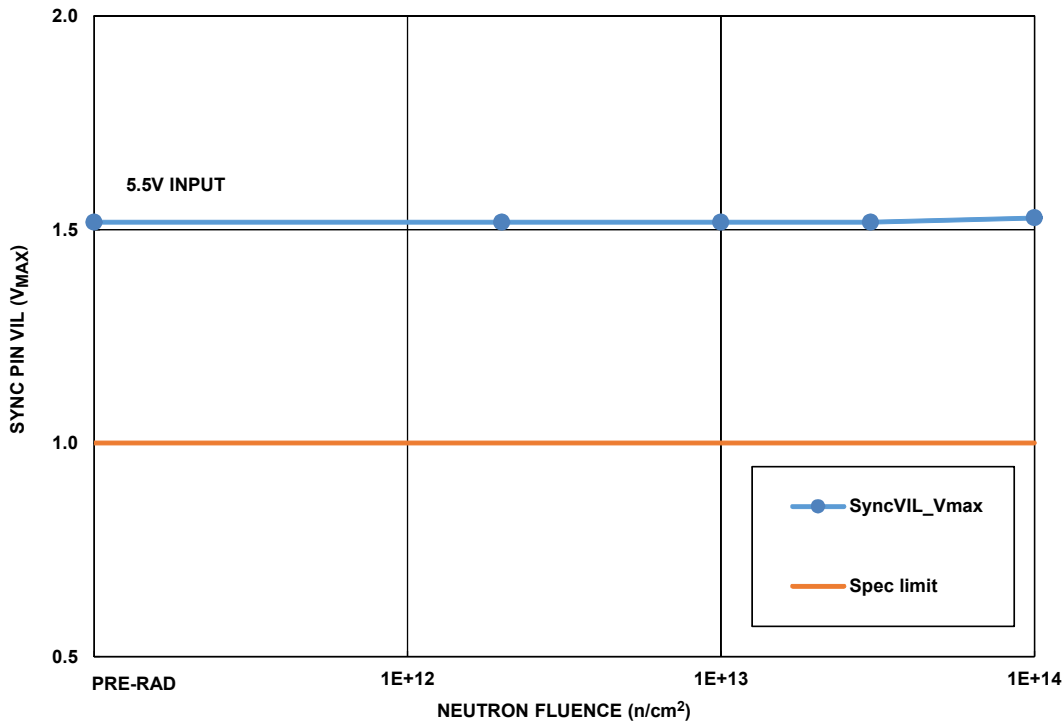

FIGURE 23. ISL70002SEH SYNC pin LOW threshold, input voltage of 5.5V, as a function of 1MeV equivalent neutron irradiation at $2 \times 10^{12} \text{ n/cm}^2$, $1 \times 10^{13} \text{ n/cm}^2$, $3 \times 10^{13} \text{ n/cm}^2$, and $1 \times 10^{14} \text{ n/cm}^2$. Sample size for each cell was five. The post total dose irradiation SMD limit is 1.0V maximum to be applied for the input to be considered low.

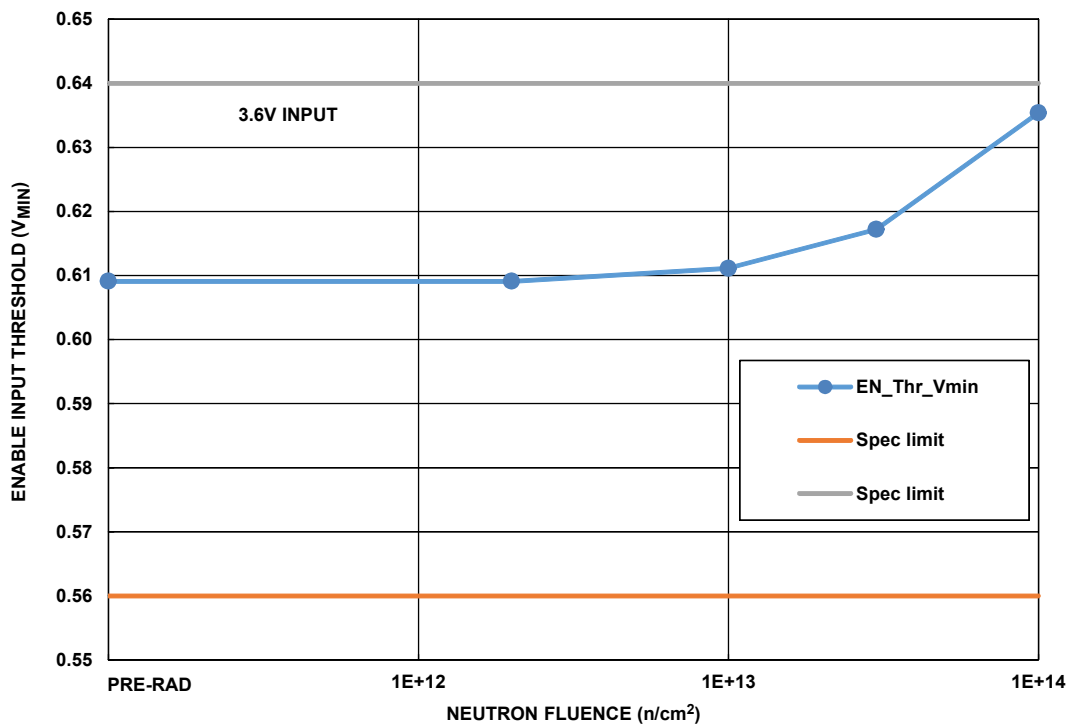

FIGURE 24. ISL70002SEH Enable input threshold voltage, input voltage of 3.6V, as a function of 1MeV equivalent neutron irradiation at $2 \times 10^{12} \text{ n/cm}^2$, $1 \times 10^{13} \text{ n/cm}^2$, $3 \times 10^{13} \text{ n/cm}^2$, and $1 \times 10^{14} \text{ n/cm}^2$. Sample size for each cell was five. The post total dose irradiation SMD limits are 0.560V to 0.640V.

Variables Data Plots (Continued)

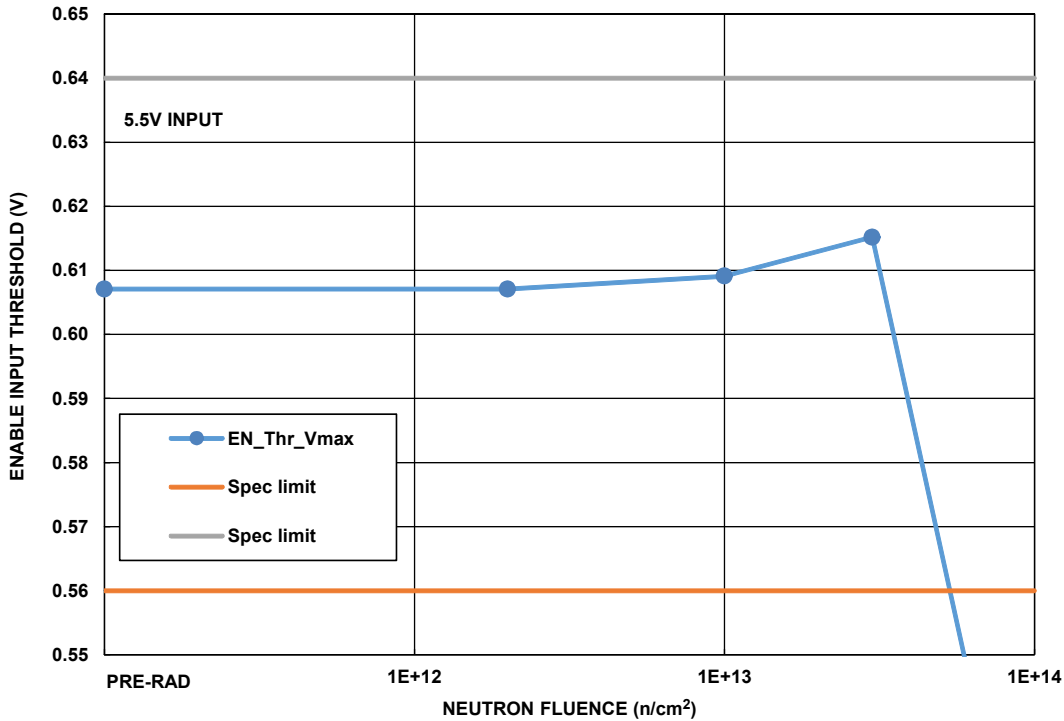

FIGURE 25. ISL70002SEH Enable input threshold voltage, input voltage of 5.5V, as a function of 1MeV equivalent neutron irradiation at $2 \times 10^{12} \text{ n/cm}^2$, $1 \times 10^{13} \text{ n/cm}^2$, $3 \times 10^{13} \text{ n/cm}^2$, and $1 \times 10^{14} \text{ n/cm}^2$. Sample size for each cell was five. The post total dose irradiation SMD limits are 0.560V to 0.640V.

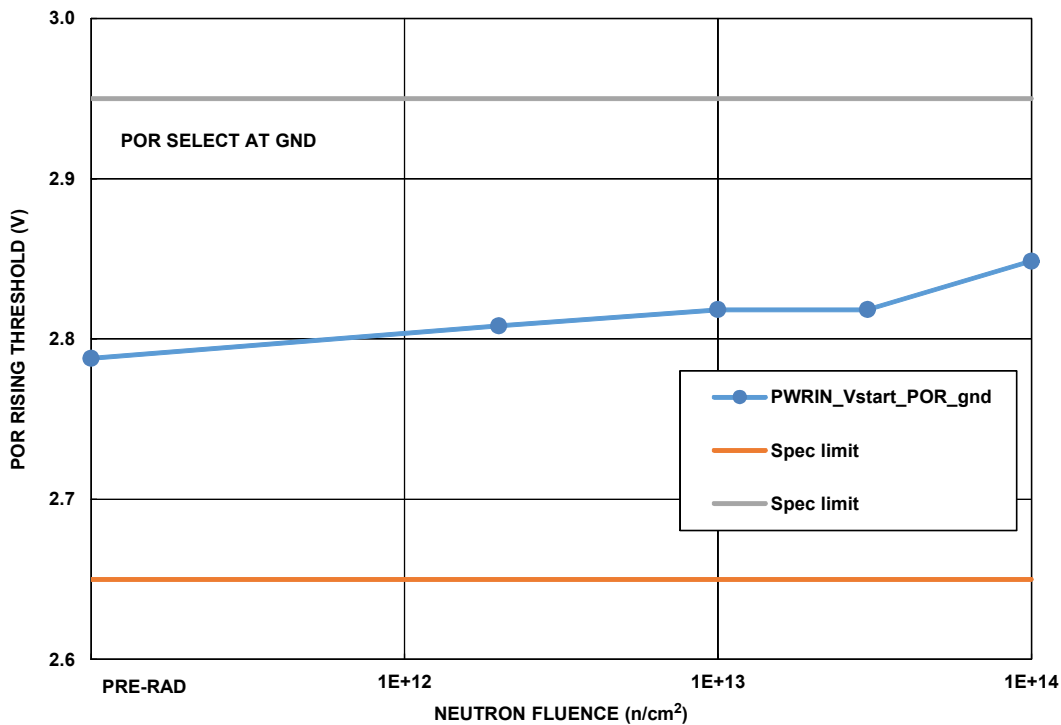

FIGURE 26. ISL70002SEH POR rising threshold, PORSEL at ground, as a function of 1MeV equivalent neutron irradiation at $2 \times 10^{12} \text{ n/cm}^2$, $1 \times 10^{13} \text{ n/cm}^2$, $3 \times 10^{13} \text{ n/cm}^2$, and $1 \times 10^{14} \text{ n/cm}^2$. Sample size for each cell was five. The post total dose irradiation SMD limits are 2.65V to 2.95V.

Variables Data Plots (Continued)

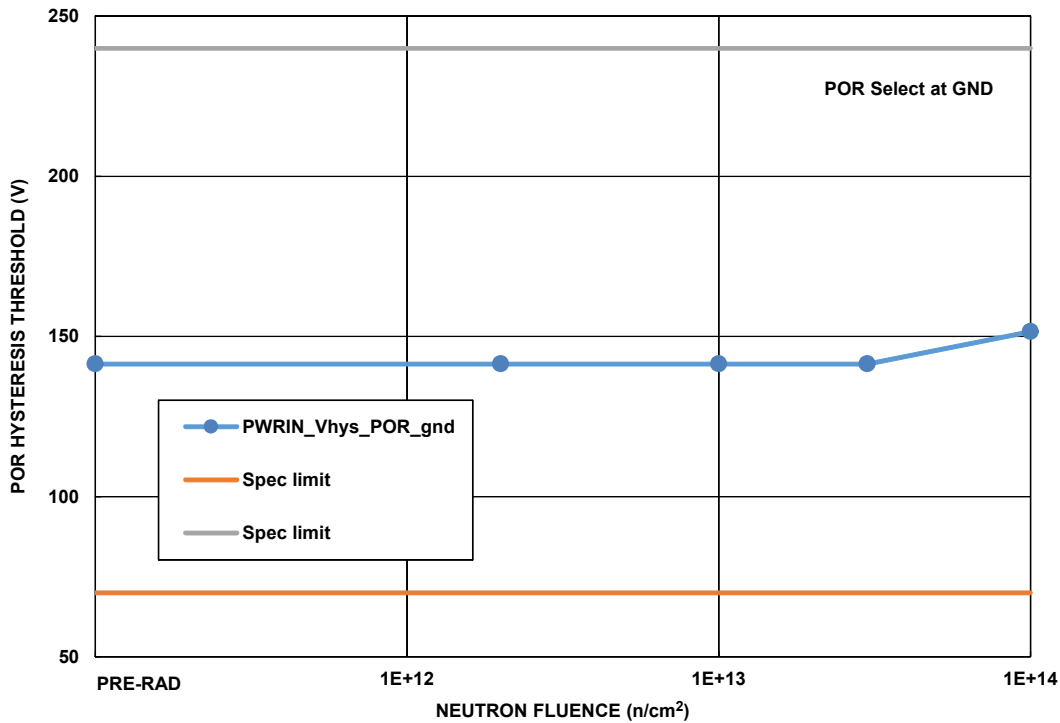

FIGURE 27. ISL70002SEH POR hysteresis, PORSEL at ground, as a function of 1MeV equivalent neutron irradiation at $2 \times 10^{12} \text{ n/cm}^2$, $1 \times 10^{13} \text{ n/cm}^2$, $3 \times 10^{13} \text{ n/cm}^2$, and $1 \times 10^{14} \text{ n/cm}^2$. Sample size for each cell was five. The post total dose irradiation SMD limits are 70.0mV to 240.0mV.

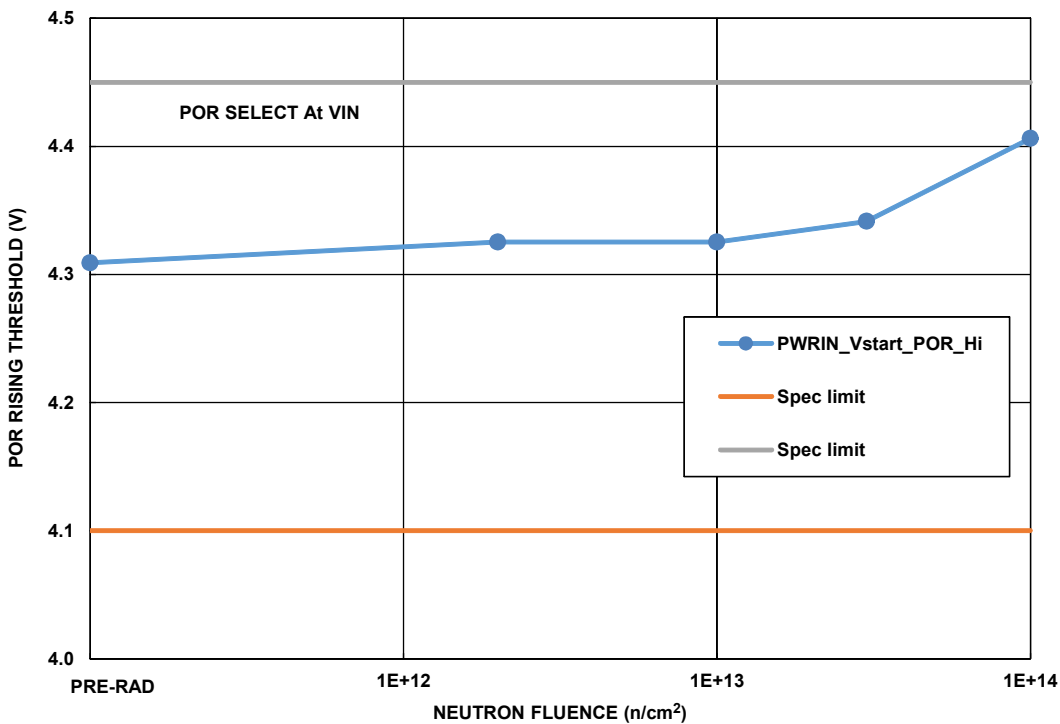

FIGURE 28. ISL70002SEH POR rising threshold, PORSEL at V_{IN} , as a function of 1MeV equivalent neutron irradiation at $2 \times 10^{12} \text{ n/cm}^2$, $1 \times 10^{13} \text{ n/cm}^2$, $3 \times 10^{13} \text{ n/cm}^2$, and $1 \times 10^{14} \text{ n/cm}^2$. Sample size for each cell was five. The post total dose irradiation SMD limits are 4.10V to 4.45V.

Variables Data Plots (Continued)

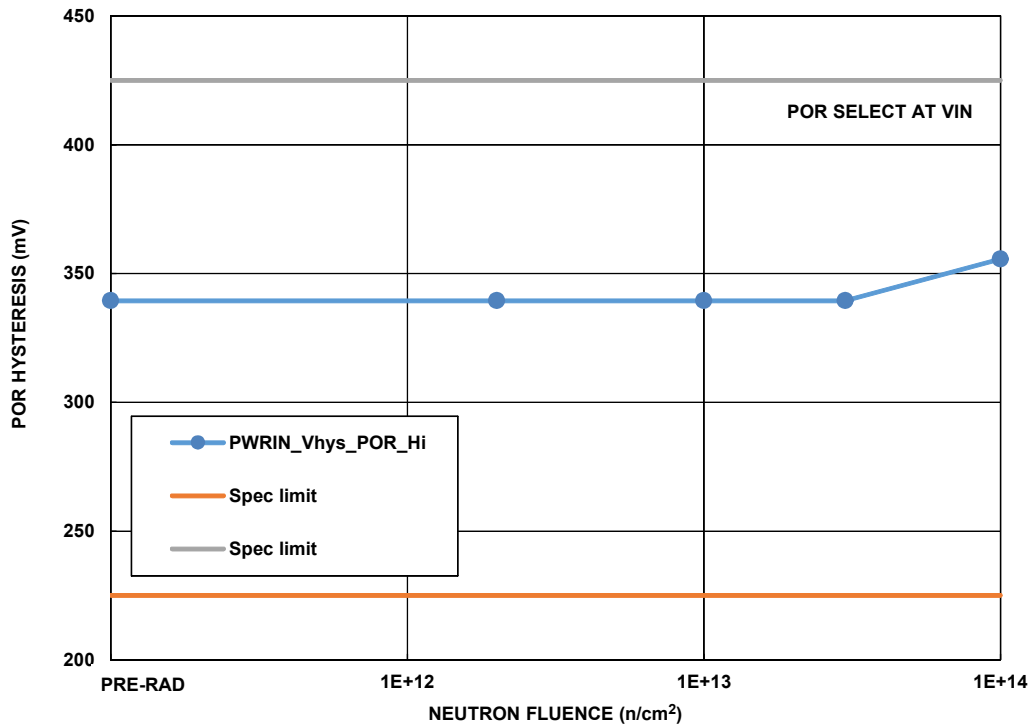

FIGURE 29. ISL70002SEH POR hysteresis, PORSEL at V_{IN}, as a function of 1MeV equivalent neutron irradiation at 2x10¹²n/cm², 1x10¹³n/cm², 3x10¹³n/cm², and 1x10¹⁴n/cm². Sample size for each cell was five. The post total dose irradiation SMD limits are 225.0mV to 425.0mV.

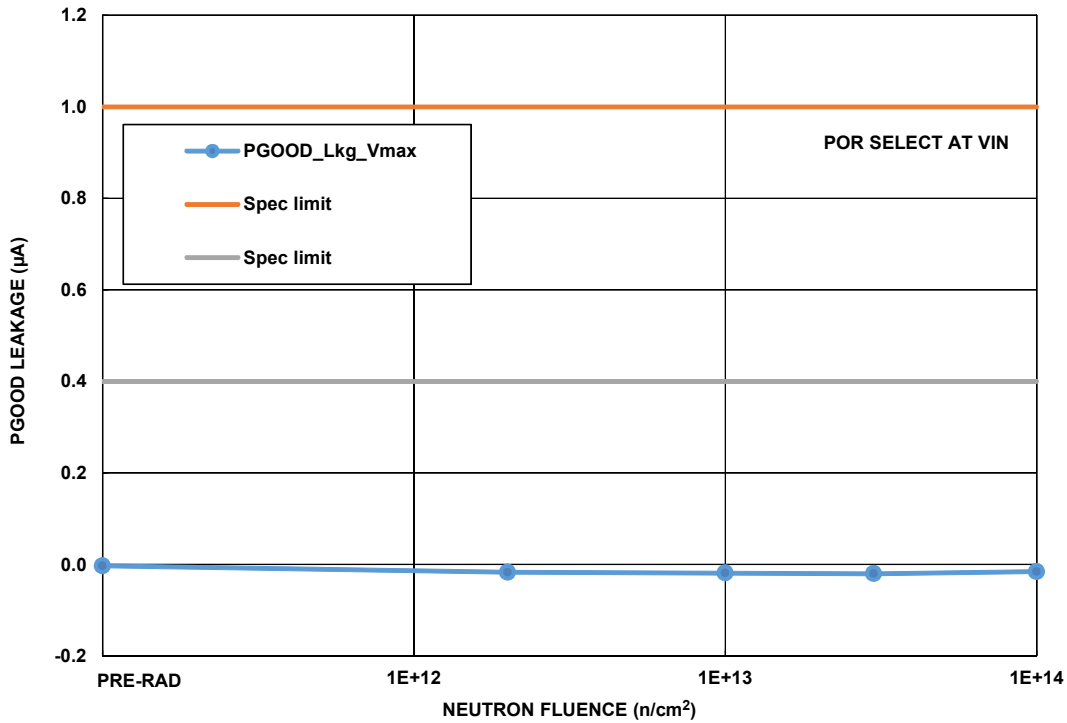

FIGURE 30. ISL70002SEH PGOOD input leakage as a function of 1MeV equivalent neutron irradiation at 2x10¹²n/cm², 1x10¹³n/cm², 3x10¹³n/cm², and 1x10¹⁴n/cm². Sample size for each cell was five. The post total dose irradiation SMD limit is 1.0µA maximum.

Variables Data Plots (Continued)

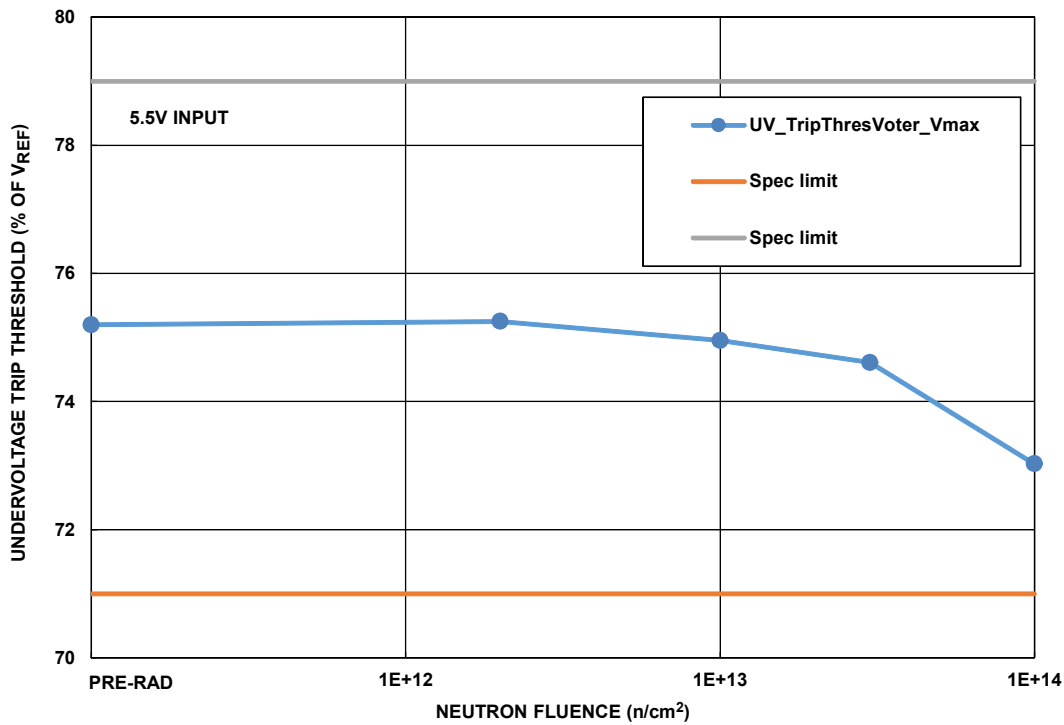

FIGURE 31. ISL70002SEH undervoltage trip threshold as a function of 1MeV equivalent neutron irradiation at $2 \times 10^{12} \text{ n/cm}^2$, $1 \times 10^{13} \text{ n/cm}^2$, $3 \times 10^{13} \text{ n/cm}^2$, and $1 \times 10^{14} \text{ n/cm}^2$. Sample size for each cell was five. The post total dose irradiation SMD limits are 71.0% to 79.0%.

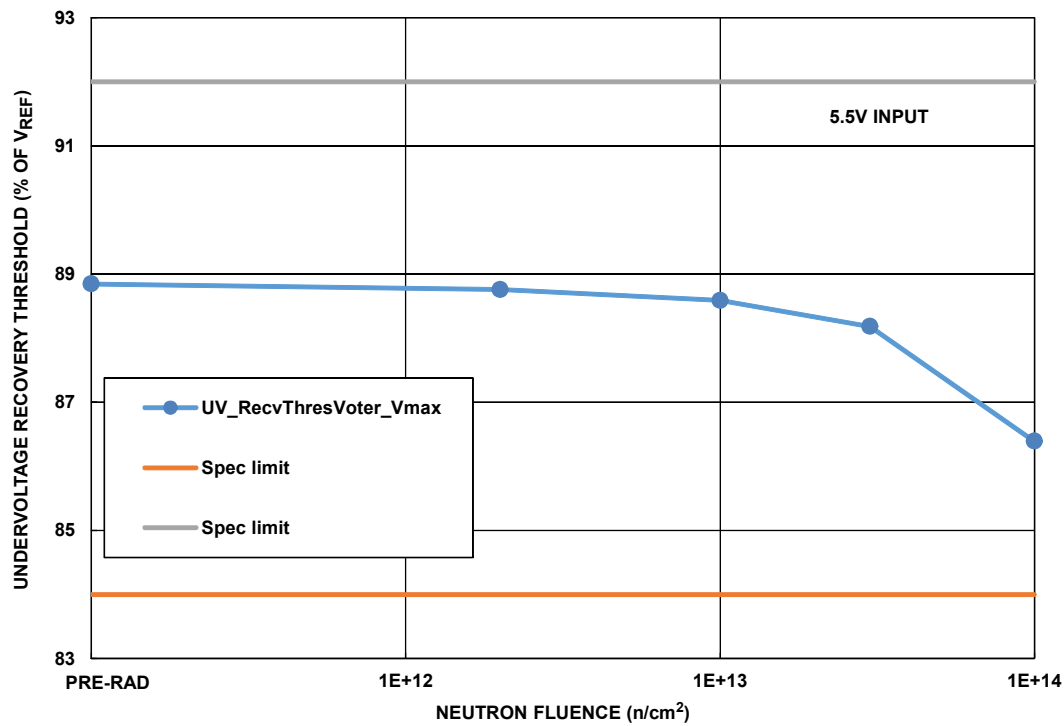

FIGURE 32. ISL70002SEH undervoltage recovery threshold as a function of 1MeV equivalent neutron irradiation at $2 \times 10^{12} \text{ n/cm}^2$, $1 \times 10^{13} \text{ n/cm}^2$, $3 \times 10^{13} \text{ n/cm}^2$, and $1 \times 10^{14} \text{ n/cm}^2$. Sample size for each cell was five. The post total dose irradiation SMD limits are 84.0% to 92.0%.

Variables Data Plots (Continued)

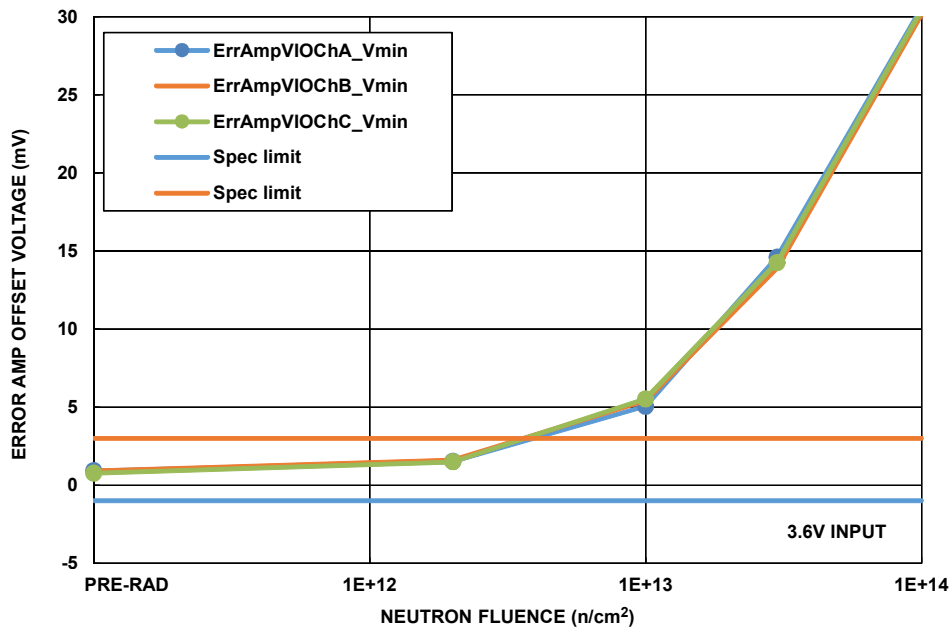

FIGURE 33. ISL70002SEH error amplifier input offset voltage, channels A, B, and C, at an input voltage of 3.6V, as a function of 1MeV equivalent neutron irradiation at $2 \times 10^{12} \text{ n/cm}^2$, $1 \times 10^{13} \text{ n/cm}^2$, $3 \times 10^{13} \text{ n/cm}^2$, and $1 \times 10^{14} \text{ n/cm}^2$. Sample size for each cell was five. The post total dose irradiation SMD limits are -1.0mV to 3.0mV.

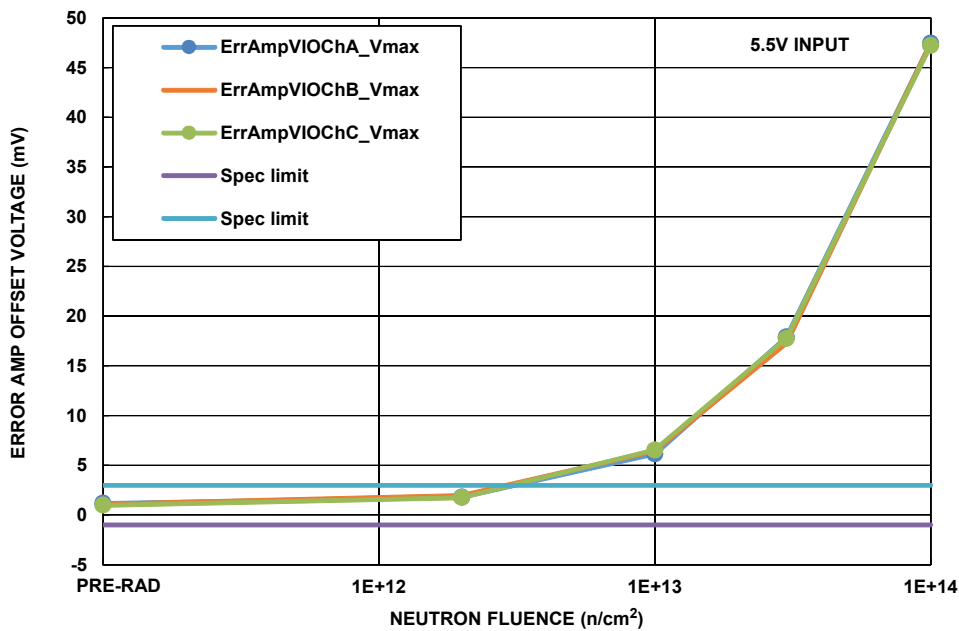

FIGURE 34. ISL70002SEH error amplifier input offset voltage, channels A, B, and C, at an input voltage of 5.5V as a function of 1MeV equivalent neutron irradiation at $2 \times 10^{12} \text{ n/cm}^2$, $1 \times 10^{13} \text{ n/cm}^2$, $3 \times 10^{13} \text{ n/cm}^2$, and $1 \times 10^{14} \text{ n/cm}^2$. Sample size for each cell was five. The post total dose irradiation SMD limits are -1.0mV to 3.0mV.

Variables Data Plots (Continued)

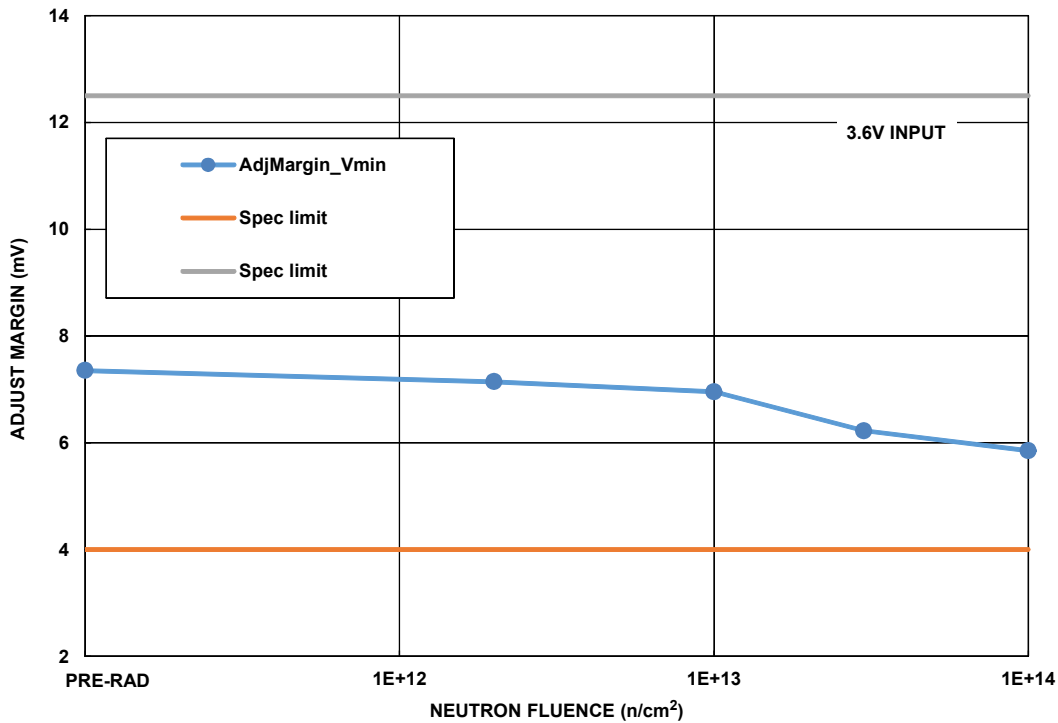

FIGURE 35. ISL70002SEH adjust margin as a function of 1MeV equivalent neutron irradiation at $2 \times 10^{12} \text{ n/cm}^2$, $1 \times 10^{13} \text{ n/cm}^2$, $3 \times 10^{13} \text{ n/cm}^2$, and $1 \times 10^{14} \text{ n/cm}^2$. Sample size for each cell was five. This is an informational parameter and is not specified in the SMD; the internal limits are 4mV to 12.5mV.

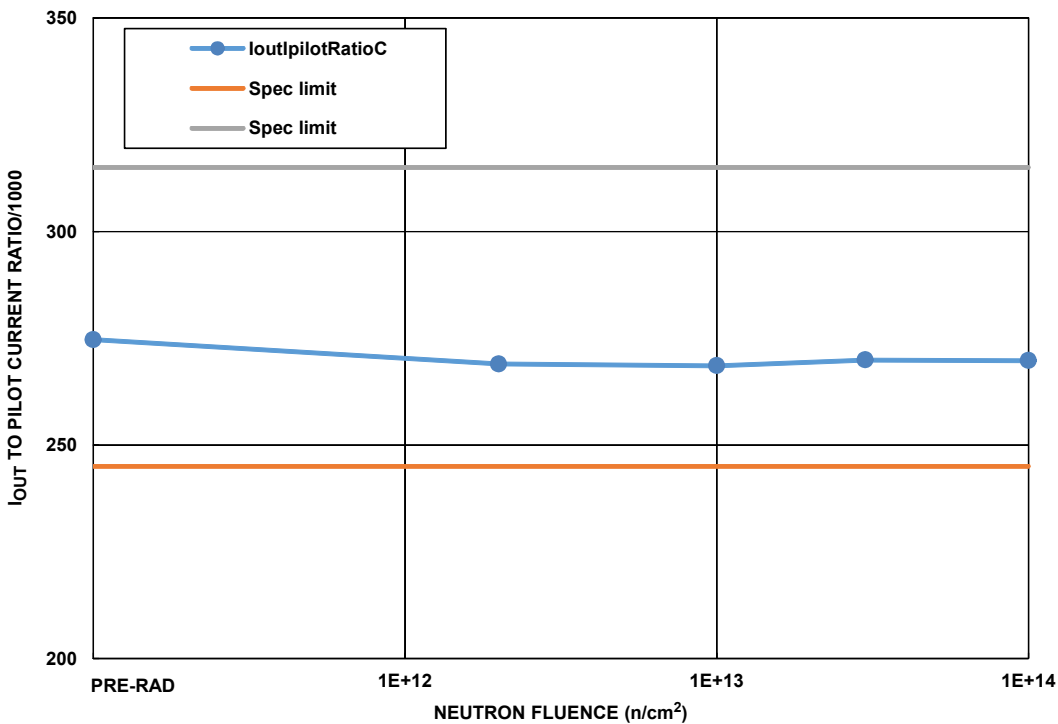

FIGURE 36. ISL70002SEH output current to pilot device current ratio (1000x scale factor) as a function of 1MeV equivalent neutron irradiation at $2 \times 10^{12} \text{ n/cm}^2$, $1 \times 10^{13} \text{ n/cm}^2$, $3 \times 10^{13} \text{ n/cm}^2$, and $1 \times 10^{14} \text{ n/cm}^2$. Sample size for each cell was five. This is an informational parameter and is not specified in the SMD; the internal limits are 245 to 315.

Variables Data Plots (Continued)

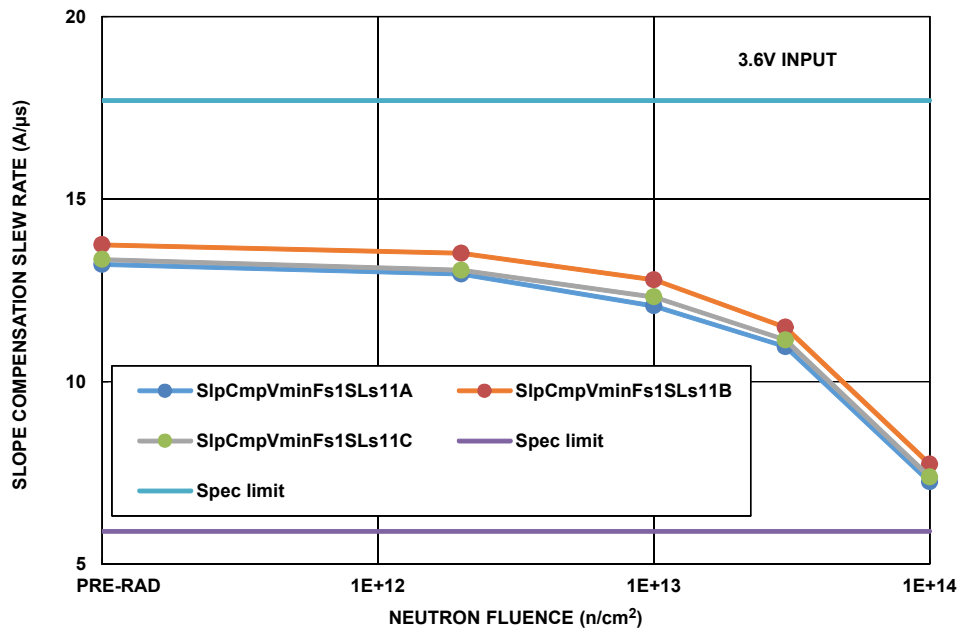

FIGURE 37. ISL70002SEH slope compensation current slew rate, input voltage of 3.6V, channels A, B, and C, as a function of 1MeV equivalent neutron irradiation at $2 \times 10^{12} \text{ n/cm}^2$, $1 \times 10^{13} \text{ n/cm}^2$, $3 \times 10^{13} \text{ n/cm}^2$, and $1 \times 10^{14} \text{ n/cm}^2$. Sample size for each cell was five. The post total dose irradiation SMD limits are 5.9A/μs to 17.7A/μs.

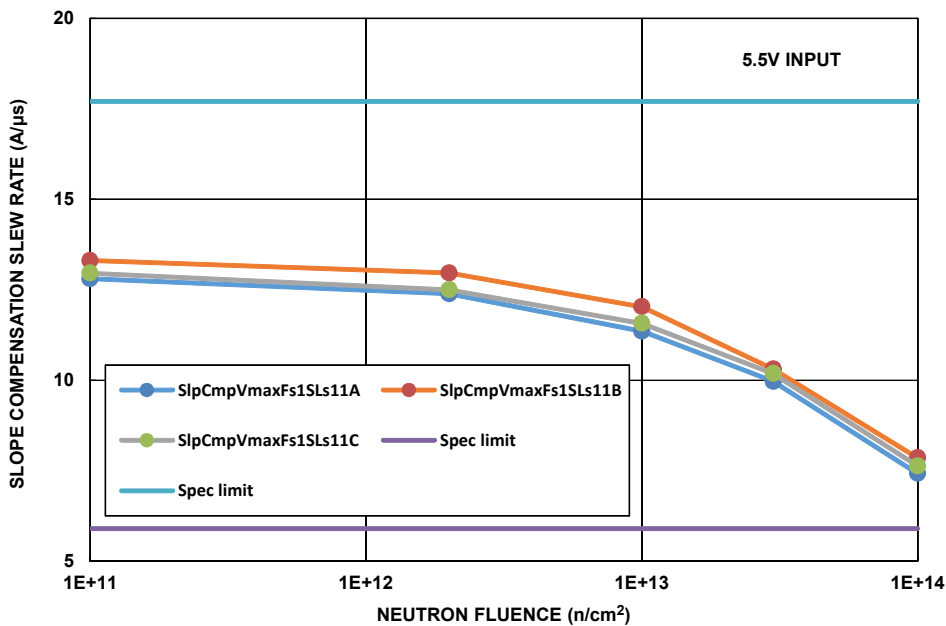

FIGURE 38. ISL70002SEH slope compensation current slew rate, input voltage of 5.5V, channels A, B, and C, as a function of 1MeV equivalent neutron irradiation at $2 \times 10^{12} \text{ n/cm}^2$, $1 \times 10^{13} \text{ n/cm}^2$, $3 \times 10^{13} \text{ n/cm}^2$, and $1 \times 10^{14} \text{ n/cm}^2$. Sample size for each cell was five. The post total dose irradiation SMD limits are 5.9A/μs to 17.7A/μs.

Variables Data Plots (Continued)

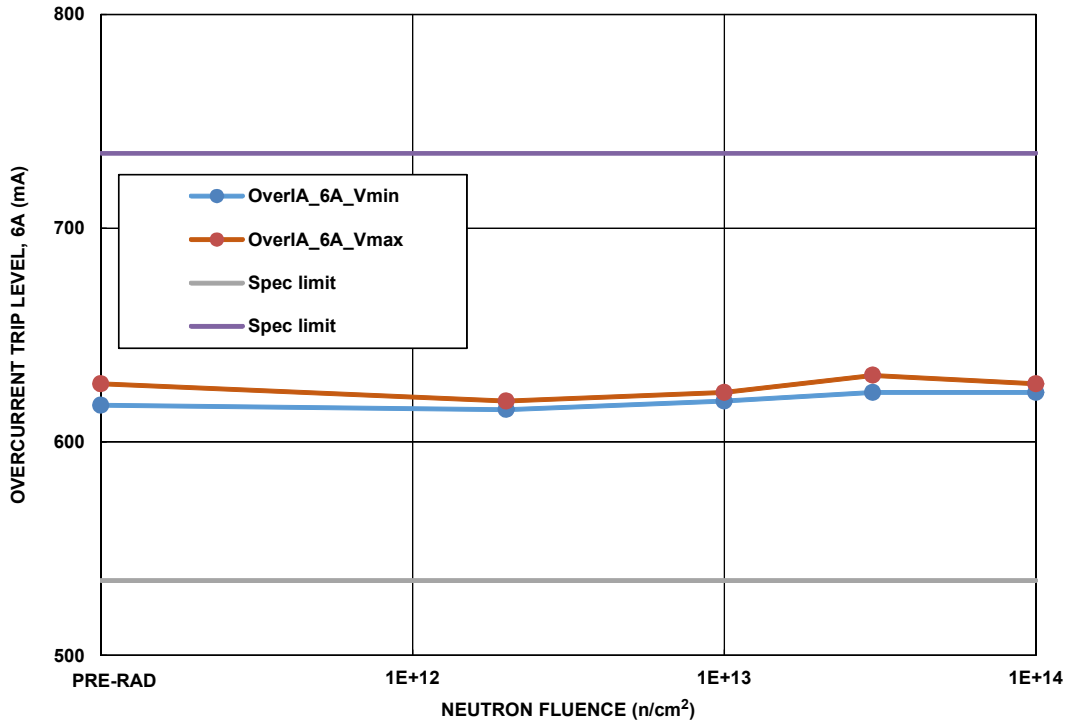

FIGURE 39. ISL70002SEH overcurrent trip level, 6A, input voltage of 3.6V (blue) and 5.5V (red), as a function of 1MeV equivalent neutron irradiation at $2 \times 10^{12} \text{ n/cm}^2$, $1 \times 10^{13} \text{ n/cm}^2$, $3 \times 10^{13} \text{ n/cm}^2$, and $1 \times 10^{14} \text{ n/cm}^2$. Sample size for each cell was five. The post total dose irradiation SMD limits are 535.0mA to 735.0mA.

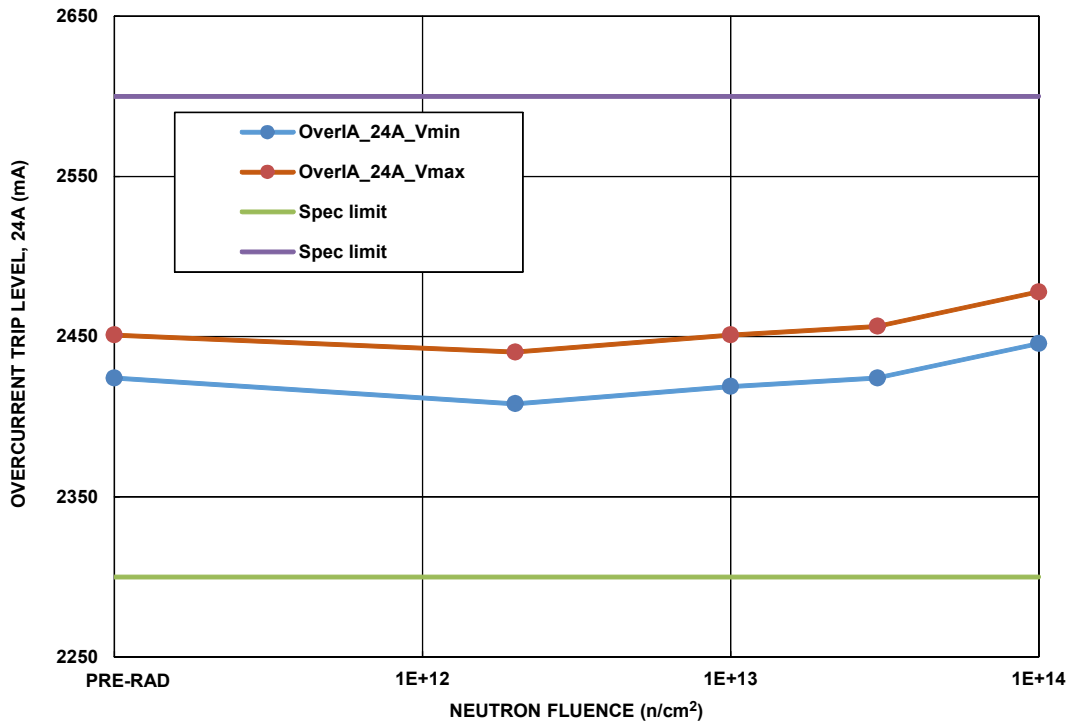

FIGURE 40. ISL70002SEH overcurrent trip level, 24A, input voltages of 3.6V (blue) and 5.5V (red), as a function of 1MeV equivalent neutron irradiation at $2 \times 10^{12} \text{ n/cm}^2$, $1 \times 10^{13} \text{ n/cm}^2$, $3 \times 10^{13} \text{ n/cm}^2$, and $1 \times 10^{14} \text{ n/cm}^2$. Sample size for each cell was five. The post total dose irradiation SMD limits are 2300mA to 2600mA.

Variables Data Plots (Continued)

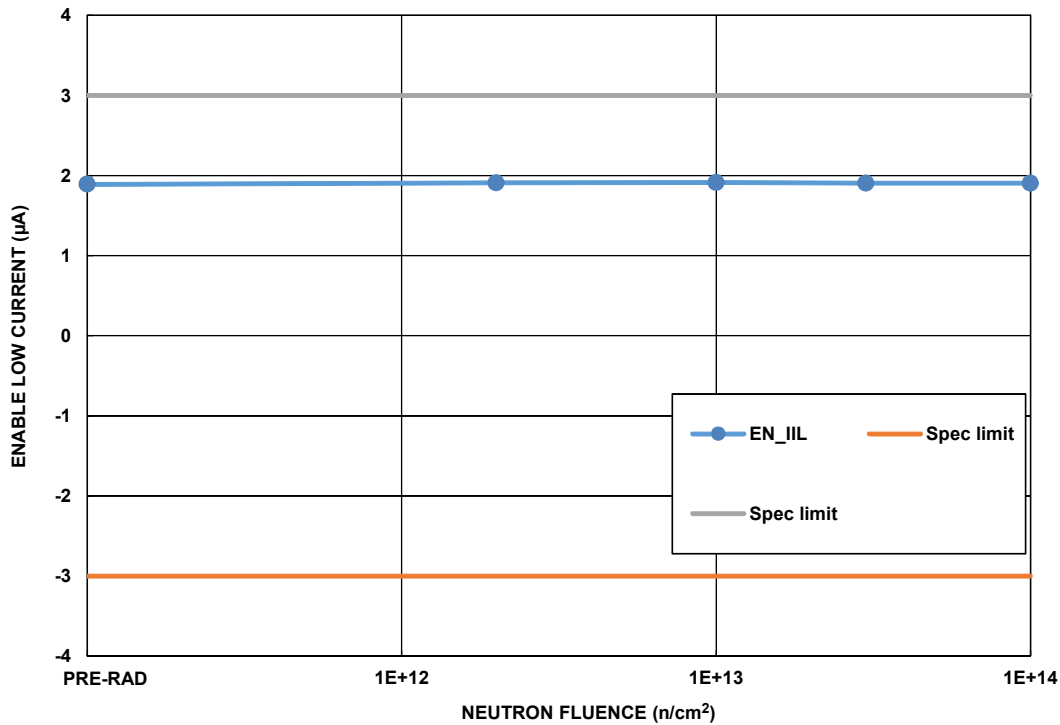

FIGURE 41. ISL70002SEH enable LOW current as a function of 1MeV equivalent neutron irradiation at $2 \times 10^{12} \text{ n/cm}^2$, $1 \times 10^{13} \text{ n/cm}^2$, $3 \times 10^{13} \text{ n/cm}^2$, and $1 \times 10^{14} \text{ n/cm}^2$. Sample size for each cell was five. The post total dose irradiation SMD limits are $-3.0 \mu\text{A}$ to $3.0 \mu\text{A}$.

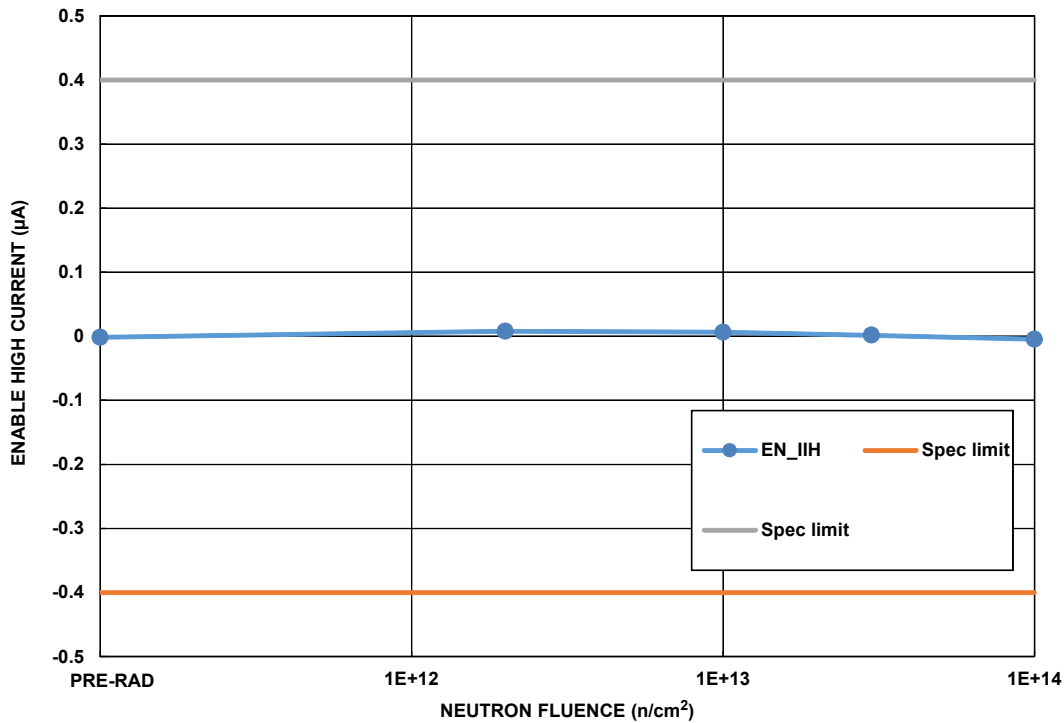

FIGURE 42. ISL70002SEH enable HIGH current as a function of 1MeV equivalent neutron irradiation at $2 \times 10^{12} \text{ n/cm}^2$, $1 \times 10^{13} \text{ n/cm}^2$, $3 \times 10^{13} \text{ n/cm}^2$, and $1 \times 10^{14} \text{ n/cm}^2$. Sample size for each cell was five. This is an informational parameter and is not specified in the SMD; the internal limits are $-0.4 \mu\text{A}$ to $0.4 \mu\text{A}$.

Variables Data Plots (Continued)

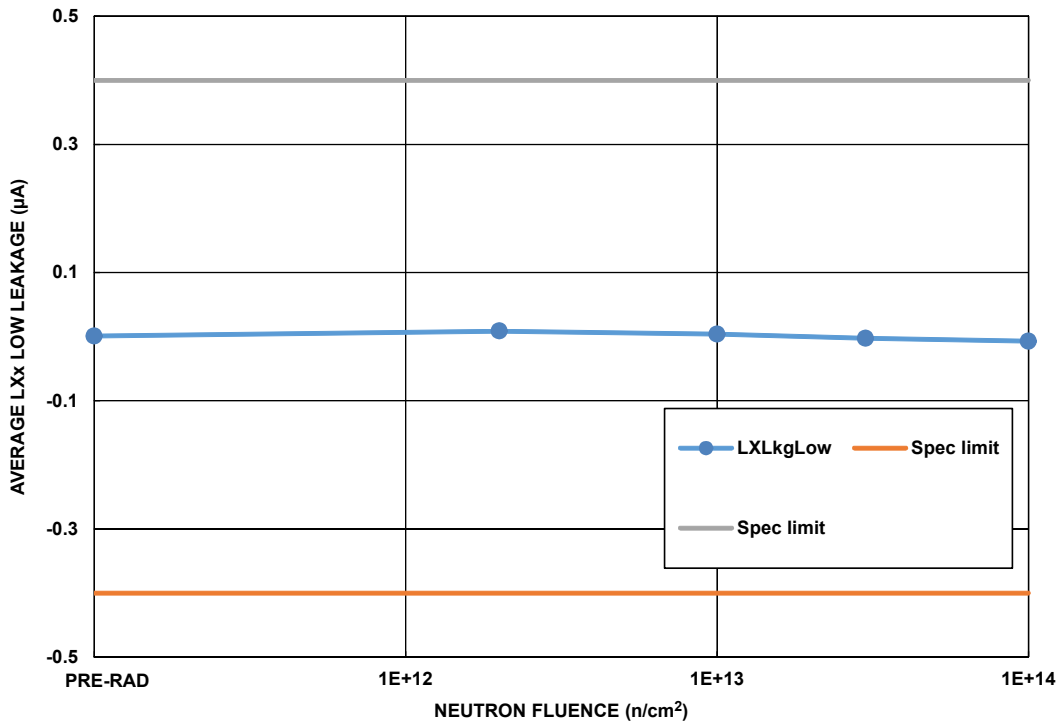

FIGURE 43. ISL70002SEH average LXx LOW leakage as a function of 1MeV equivalent neutron irradiation at $2 \times 10^{12} \text{ n/cm}^2$, $1 \times 10^{13} \text{ n/cm}^2$, $3 \times 10^{13} \text{ n/cm}^2$, and $1 \times 10^{14} \text{ n/cm}^2$. Sample size for each cell was five. The average LXx LOW leakage is an informational parameter and is not specified in the SMD; the internal limits are $-0.4 \mu\text{A}$ to $0.4 \mu\text{A}$.

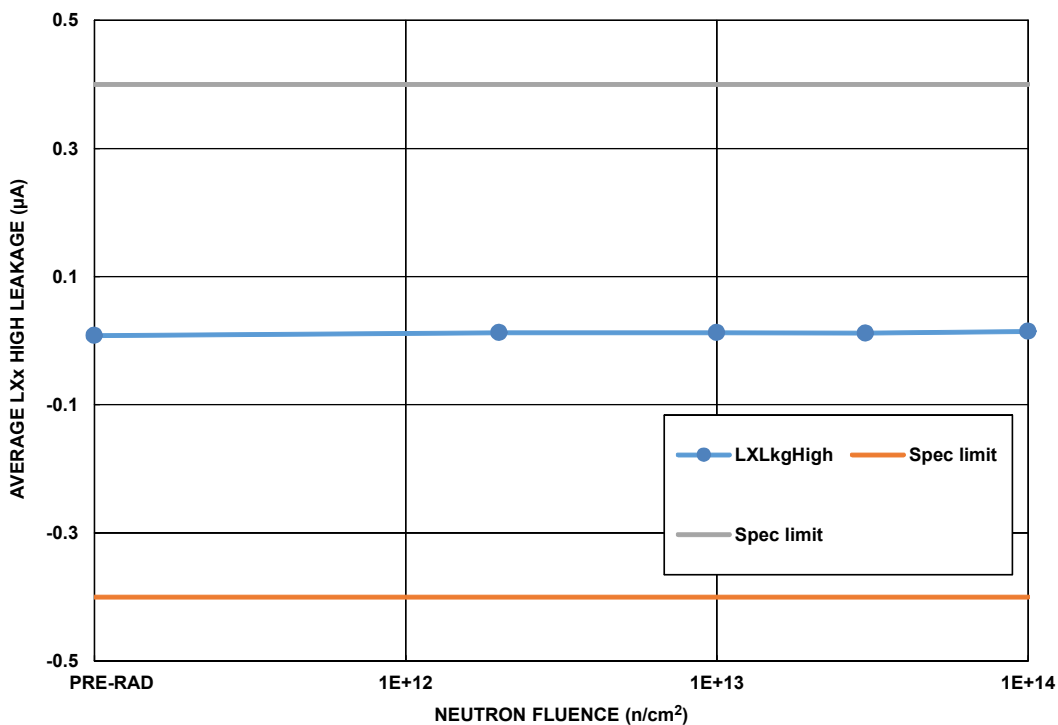

FIGURE 44. ISL70002SEH average LXx HIGH leakage as a function of 1MeV equivalent neutron irradiation at $2 \times 10^{12} \text{ n/cm}^2$, $1 \times 10^{13} \text{ n/cm}^2$, $3 \times 10^{13} \text{ n/cm}^2$, and $1 \times 10^{14} \text{ n/cm}^2$. Sample size for each cell was five. The average LXx HIGH leakage is an informational parameter and is not specified in the SMD; the internal limits are $-0.4 \mu\text{A}$ to $0.4 \mu\text{A}$.

Conclusion

This report summarizes results of 1MeV equivalent neutron testing of the ISL70002SEH integrated FET point of load regulator. The test was conducted in order to determine the sensitivity of the part to Displacement Damage (DD) caused by neutron or proton environments. Neutron fluences ranged from $2 \times 10^{12} \text{ n/cm}^2$ to $1 \times 10^{14} \text{ n/cm}^2$. This project was carried out in collaboration with VPT, Inc. (Blacksburg, VA), and their support is gratefully acknowledged.

ATE characterization testing at all downpoints showed rejects to the datasheet limits after $1 \times 10^{13} \text{ n/cm}^2$, $3 \times 10^{13} \text{ n/cm}^2$, and $1 \times 10^{14} \text{ n/cm}^2$. Variables data for selected parameters is presented in [Figures 2](#) through [44](#). The part met all specifications ('Bin 1') after $2 \times 10^{11} \text{ n/cm}^2$ and was functional

after $1 \times 10^{13} \text{ n/cm}^2$ and $3 \times 10^{13} \text{ n/cm}^2$; it may be usable at these levels with some derating.

The part was effectively nonfunctional after $1 \times 10^{14} \text{ n/cm}^2$, for example, see [Figures 6](#) and [7](#), which show reference voltage degradation, [Figures 8](#) and [9](#) showing oscillator frequency, [Figures 13](#) and [14](#) showing supply current, [Figures 33](#) and [34](#) showing error amplifier input offset voltage, and [Figures 37](#) and [38](#) showing the slope compensation current slew rate.

Appendices

[Table 2](#) shows the reported parameters. The limits are from the SMD and are provided for guidance only because the part is not designed or guaranteed for the neutron environment.

TABLE 2. REPORTED PARAMETERS

FIGURE	PARAMETER	LIMIT, LOW	LIMIT, HIGH	UNITS	NOTES
2	Standby Supply Current	-	4.0	mA	I _{SHARE} disabled, 3.6V _{IN}
3	Standby Supply Current	-	6.0	mA	I _{SHARE} disabled, 5.5V _{IN}
4	Standby Supply Current	-	7.0	mA	I _{SHARE} enabled, 5.5V _{IN}
5	Standby Supply Current	-	11.0	mA	I _{SHARE} enabled, 5.5V _{IN}
6	Reference Voltage	0.594	0.604	V	3.6V _{IN}
7	Reference Voltage	0.594	0.604	V	5.5V _{IN}
8	Oscillator Frequency	850	1150	kHz	3.6V _{IN}
9	Oscillator Frequency	850	1150	kHz	5.5V _{IN}
10	Minimum LX On-Time	-	300.0	ns	3.6V _{IN}
11	Minimum LX On-Time	-	275.0	ns	5.5V _{IN}
12	Minimum LX Off-Time	-	50.0	ns	5.5V _{IN}
13	Operating Supply Current	-	65.0	mA	3.6V _{IN}
14	Operating Supply Current	-	105.0	mA	5.5V _{IN}
15	Maximum I _{SHARE} Output	1.7	2.9	A	Informational parameter
16	Average r _{DS(ON)} , Lower Device	95	200	mΩ	Informational parameter
17	Parallel r _{DS(ON)} , Lower Device	7	30	mΩ	
18	Average r _{DS(ON)} , Upper Device	150	225	mΩ	Informational parameter
19	Parallel r _{DS(ON)} , Upper Device	7	40	mΩ	
20	SYNC Pin High Threshold	-	2.3	V	3.6V _{IN}
21	SYNC Pin High Threshold	-	2.3	V	5.5V _{IN}
22	SYNC Pin Low Threshold	1.0	-	V	3.6V _{IN}
23	SYNC Pin Low Threshold	1.0	-	V	5.5V _{IN}
24	Enable Input Threshold Voltage	0.560	0.640	V	3.6V _{IN}
25	Enable Input Threshold Voltage	0.560	0.640	V	5.5V _{IN}
26	POR Rising Threshold Voltage	2.65	2.95	V	PORSEL at ground
27	POR Hysteresis Voltage	70.0	240.0	mV	PORSEL at ground
28	POR Rising Threshold Voltage	4.10	4.45	V	PORSEL at V _{IN}
29	POR Hysteresis Voltage	225.0	425.0	mV	PORSEL at V _{IN}

TABLE 2. REPORTED PARAMETERS

FIGURE	PARAMETER	LIMIT, LOW	LIMIT, HIGH	UNITS	NOTES
30	PGOOD Input Leakage	-	1.0	μA	
31	Undervoltage Trip Threshold	71.0	79.0	%	$5.5V_{\text{IN}}$
32	Undervoltage Recovery Threshold	84.0	92.0	%	$5.5V_{\text{IN}}$
33	Error Amplifier Input Offset Voltage	-1.0	3.0	mV	Channels A, B, and C, $3.6V_{\text{IN}}$
34	Error Amplifier Input Offset Voltage	-1.0	3.0	mV	Channels A, B, and C, $5.5V_{\text{IN}}$
35	Adjust Margin	-1.0	3.0	mV	Informational parameter
36	Output Current to Pilot Ratio	245	315	-	Informational parameter
37	Slope Compensation Slew Rate	5.9	17.7	$\text{A}/\mu\text{s}$	$3.6V_{\text{IN}}$
38	Slope Compensation Slew Rate	5.9	17.7	$\text{A}/\mu\text{s}$	$5.5V_{\text{IN}}$
39	Overcurrent Trip Level	535.0	735.0	mA	6A, $3.6V_{\text{IN}}$
40	Overcurrent Trip Level	2300.0	2600.0	mA	24A, $3.6V_{\text{IN}}$
41	$\text{EN}_{(\text{IIL})}$	-3.0	3.0	μA	
42	$\text{EN}_{(\text{IIH})}$	-0.4	0.4	μA	Informational parameter
43	LXx Leakage LOW	-0.4	0.4	μA	Informational parameter
44	LXx Leakage HIGH	-0.4	0.4	μA	Informational parameter

© Copyright Intersil Americas LLC 2016-2017. All Rights Reserved.
All trademarks and registered trademarks are the property of their respective owners.

Intersil Corporation reserves the right to make changes in circuit design, software and/or specifications at any time without notice. Accordingly, the reader is cautioned to verify that the document is current before proceeding.

For information regarding Intersil Corporation and its products, see www.intersil.com