

ISL70003ASEH

Single Event Effects (SEE) Testing

TR009
Rev 0.00
August 6, 2015

Introduction

The intense proton and heavy ion environment encountered in space applications can cause a variety of Single-event Effects (SEE) in electronic circuitry, including Single Event Upset (SEU), Single Event Transient (SET), Single Event Functional Interrupt (SEFI), Single Event Gate Rupture (SEGR) and Single Event Burnout (SEB). SEE can lead to system-level performance issues including disruption, degradation and destruction. For predictable and reliable space system operation, individual electronic components must be characterized to determine their SEE response. This report discusses the results of SEE testing performed on the ISL70003ASEH buck regulator.

Product Description

The ISL70003ASEH is a metal mask variant of the radiation tolerant ISL70003SEH part previously released by Intersil. The changes to the ISL70003ASEH were confined to improving the load regulation of the part at higher current levels. The basic operation of the part is unaffected by the changes and the description of the ISL70003SEH, serves as an excellent reference for the ISL70003ASEH version. The ISL70003ASEH part can support input voltages up to 14.7V and output currents to up 9A.

Product Documentation

For more information about the ISL70003SEH and ISL70003ASEH Buck Regulators, refer to the documentation shown below.

- [ISL70003SEH](#), "Radiation Hardened and SEE Hardened 3V to 13.2V, 6A Buck Regulator"
- [ISL70003ASEH](#), "Radiation and SEE Tolerant 3V to 13.2V, 9A Buck Regulator"
- [AN1913](#), "Single Event Effects Testing of the ISL70003SEH, a 3V to 13.2V, 6A Synchronous Buck Regulator"
- [AN1897](#), "Radiation Hardened and SEE Hardened 3V to 12V, 6A Synchronous Buck Regulator Evaluation Board User's Guide"
- Standard Microcircuit Drawing (SMD): [5962-14203](#)

SEE Test Objectives

Since the ISL70003ASEH, is only a metal mask variant of the ISL70003SEH the single event testing was concentrated on validating the single event performance as comparable to the parent ISL70003SEH. This consisted of duplicating the original testing results of the ISL70003SEH.

SEE Test Facility

Testing was performed at the Texas A&M University (TAMU) Radiation Effects Facility of the Cyclotron Institute heavy ion facility. This facility is coupled to a k500 superconducting cyclotron, which is capable of generating a wide range of particle beams with the various energy, flux and fluence levels needed for advanced radiation testing. The Devices Under Test (DUTs) were located in air at 40mm from the aramica window for the ion beam. Ion LET values are quoted at the DUT surface. Signals were communicated to and from the DUT test fixture through 20 foot cables connecting to the control room. Testing was done May 28th 2015.

SEE Test Setup

The test setup consisted of an ISL70003SEH engineering evaluation board with ISL70003ASEH mounted on it. The schematic for the engineering board is shown in [Figures 1](#) and [2](#). A cable connector was added to the board to allow cabling of signals from the irradiation cave to the monitor room.

The board was modified depending upon the test being run. For all tests only 150 μ F of output capacitance (C01) was used. For SET testing at PVIN = 13.2V, a 6.8 μ H inductor was used, while for all other tests the 3.3 μ H inductor of the schematic was used. During SEB testing at sourcing 11A the Schottky diode D1 was in place, however for the other tests the Schottky diode was removed. For the low voltage tests (V_{IN} = 3V and 5.5V) the PORR2 resistor was 64.7 Ω , whereas for the V_{IN} = 13.2V and higher tests the PORR2 resistor was 7.1 Ω . For the SEB testing the ROC (A&B) resistors were 2.37 Ω while for the SET testing at 3A the ROC (A&B) resistors were 8.45 Ω .

ISL70003ASEH Board Schematic

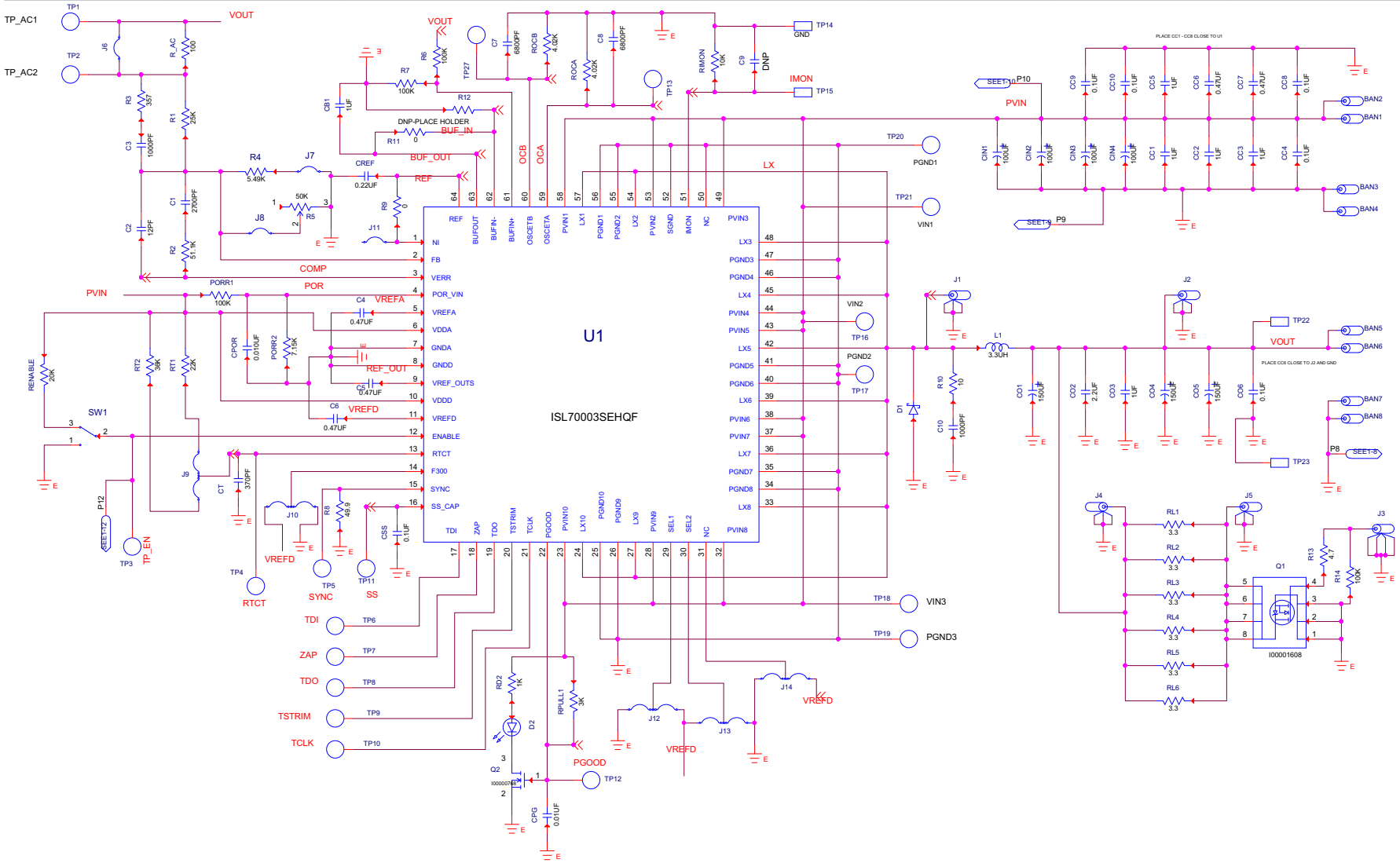

FIGURE 1. ISL70003ASEH ENGINEERING BOARD SCHEMATIC

ISL70003ASEH Board Schematic (Continued)

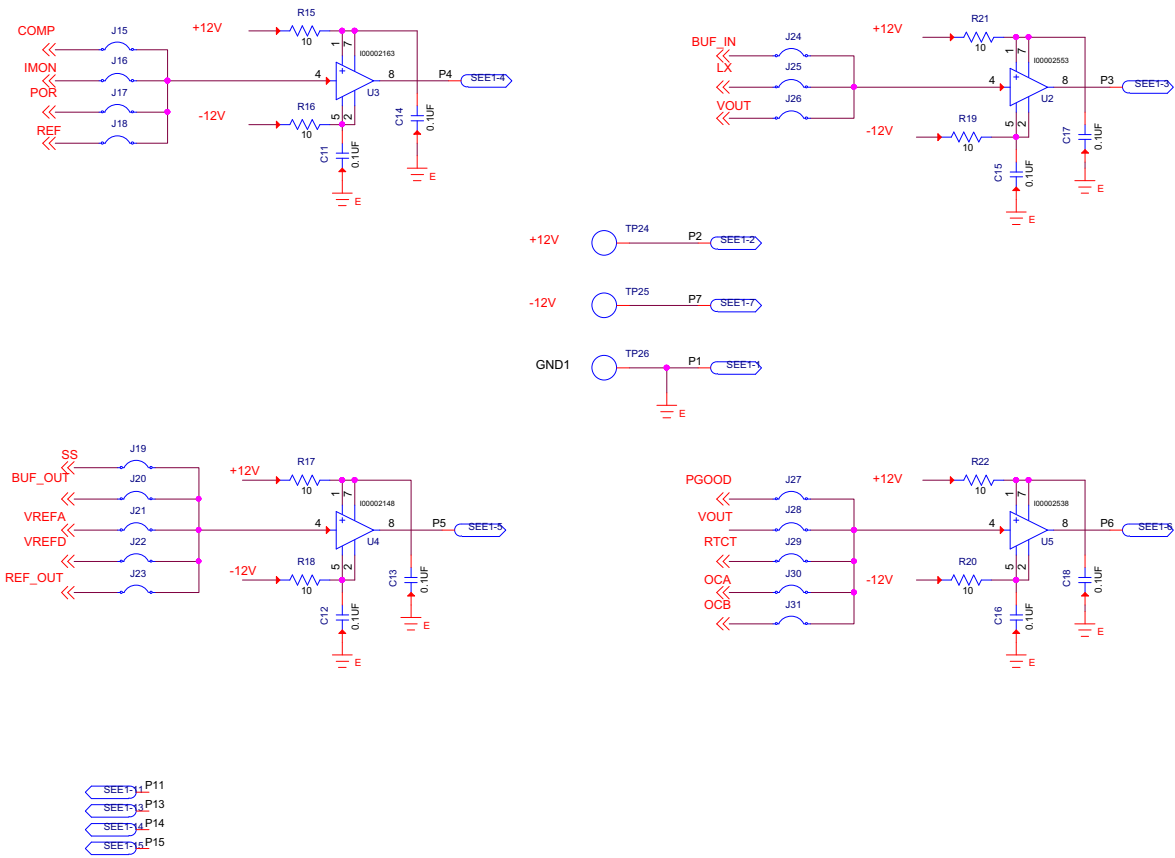

FIGURE 2. ISL70003ASEH ENGINEERING BOARD SCHEMATIC

SEB Testing of the ISL70003ASEH

Four units were first run to duplicate the SEB qualification testing originally done on the ISL70003SEH. The first three tests strictly duplicated the ISL70003SEH qualification testing. Two extra runs were also run on the ISL70003ASEH, both sourcing 11A at $V_{OUT} = 3.3V$ and $V_{IN} = 14.7V$ and $15.5V$.

Each test was done with irradiation by gold at $LET = 86.4MeV \cdot cm^2/mg$ to a fluence of 5×10^6 ion/cm² with the parts heated to a case temperature of $\pm 125^\circ C \pm 10^\circ C$. Twelve

parameters were monitored both before and after each irradiation to see if any change. The twelve parameters and the associated percentage changes are listed in [Table 2](#).

TABLE 1. SEB TESTS DONE WITH $86MeV \cdot cm^2/mg$, $T_{CASE} = \pm 125^\circ C \pm 10^\circ C$, AND 500kHz SWITCHING FREQUENCY. EACH TEST ON EACH UNIT WAS TO A FLUENCE OF 5×10^6 ions/cm².

	PVIN (V)	V _{out} (V)	I _{out} (V)
Test86 1	14.7	Disabled	0
Test86 2	14.7	3.3	+7
Test86 3	13.7	3.3	-4
Test86 4	14.7	3.3	+11
Test86 5	15.5	3.3	+11

TABLE 2. MONITOR PARAMETER DELTAS FOR THE DESTRUCTIVE SEE TESTING AT $86MeV \cdot cm^2/mg$.

DUT	TEST	ENABLE THRES (V)	DISABLE THRES (V)	I _{IN} AT LOAD (A)	I _{MON} AT LOAD (V)	V _{OUT} AT LOAD (V)	VERR (V)	V _{BUFOUT} ENABLE (V)	OCP DC THRESHOLD (A)	I _{IN} AT I _{OUT} = 0 (mA)	I _{MON} ZERO LOAD (mV)	V _{BUFOUT} DISABLE (mV)	I _{SHUTDOWN} (mA)
DUT1	Test86 1	0%	0%			0%	0%	0%	0%	1%	1%	0%	0%
	Test86 2	0%	0%	0%	0%	0%	0%	0%	0%	-1%	-2%	0%	0%
	Test86 3	0%	0%			0%	0%	0%	0%	1%	-2%	0%	0%
	Test86 4	0%	0%	0%	-2%	0%	0%	0%	0%	-1%	-6%	0%	0%
	Test86 5	0%	0%	0%	0%	0%	0%	0%	0%	-1%	-1%	0%	0%
DUT2	Test86 1	0%	0%			0%	0%	0%	0%	0%	2%	0%	0%
	Test86 2	0%	0%	0%	0%	0%	0%	0%	0%	0%	-1%	0%	0%
	Test86 3	0%	0%			0%	1%	0%	1%	0%	2%	0%	0%
	Test86 4	0%	0%	0%	1%	0%	0%	0%	0%	0%	-1%	0%	1%
	Test86 5	0%	0%	0%	-1%	0%	0%	0%	1%	-1%	-2%	0%	0%
DUT3	Test86 1	0%	0%			0%	0%	0%	0%	1%	11%	0%	0%
	Test86 2	0%	0%	0%	0%	0%	0%	0%	1%	0%	2%	0%	0%
	Test86 3	0%	0%			0%	0%	0%	0%	0%	-1%	0%	0%
	Test86 4	0%	0%	0%	-2%	0%	0%	0%	0%	0%	4%	0%	1%
	Test86 5	0%	0%	0%	-1%	0%	0%	0%	-1%	-1%	-3%	0%	1%
DUT4	Test86 1	0%	0%			0%	0%	0%	1%	0%	3%	0%	0%
	Test86 2	1%	0%	0%	0%	0%	0%	0%	-1%	0%	-3%	0%	1%
	Test86 3	0%	0%			0%	0%	0%	0%	0%	-3%	0%	2%
	Test86 4	0%	0%	0%	-2%	0%	0%	0%	0%	-1%	-3%	-4%	3%
	Test86 5	0%	0%	0%	-1%	0%	0%	0%	1%	1%	4%	0%	-2%

With few exceptions the deltas are all within a few percent and those that are not, they are still small enough to be attributed to measurement repeatability. The conclusion is that the parts did not display any indication of destructive single event effects. The last two tests are especially interesting in that they went beyond the limits of the original ISL70003SEH SEE qualification testing.

An attempt was made to push PVIN to 16.5V with IOUT at 11A, but the first part tested there showed clear changes in the zero load operating current (114.0mA to 120.5mA) and the shutdown current (7.51mA to 32.4mA) so that it was clear some permanent damage had resulted. The other three parts were not run to this level as a failure was already in hand.

Destructive SEE testing was also carried out at an LET of 43MeV • cm²/mg (silver and zero degree incidence). The testing done was slightly different from that done at the higher LET in that the PVIN was pushed increased and the 7A IOUT was skipped. The tests carried out are listed in [Table 3](#).

TABLE 3. TESTS DONE WITH 43MeV • cm²/mg, T_{CASE} = 125°C ±10°C AND 500kHz SWITCHING FREQUENCY. EACH TEST FOR EACH UNIT WAS TO A FLUENCE of 5x10⁶ Ion/cm².

TEST	PVIN (V)	Vout (V)	IOUT (A)
Test43 1	15.5	Disabled	0
Test43 2	15.5	3.3	+11
Test43 3	14.5	3.3	-4
Test43 4	16.5	Disabled	0
Test43 5	16.5	3.3	+11
Test43 6	15.5	3.3	-4

The percentage change in the monitored parameters is presented in [Table 4](#).

TABLE 4. MONITOR PARAMETER DELTAS FOR THE DESTRUCTIVE SEE TESTING AT 43MeV • cm²/mg

DUT	TEST	ENABLE THRES (V)	DISABLE THRES (V)	I_IN AT LOAD (mV)	I_MON AT LOAD (mV)	V_OUT AT LOAD (V)	VERR (V)	V_BUFOUT ENABLE (V)	OCP DC THRESHOLD (A)	I_IN AT I_OUT = 0 (mA)	I_MON ZERO LOAD (mV)	V_BUFOUT DISABLE (mV)	I_SHUTDOWN (mA)
DUT5	Test43 1	0%	0%			0%	0%	0%	0%	-1%	2%	0%	0%
	Test43 2	0%	0%	0%	-1%	0%	0%	-1%	0%	-1%	-6%	0%	3%
	Test43 3	0%	0%			0%	0%	0%	-1%	0%	1%	0%	-1%
	Test43 4	0%	1%			0%	0%	0%	1%	0%	0%	0%	-1%
	Test43 5	0%	0%	0%	-1%	0%	0%	0%	0%	0%	-1%	0%	1%
	Test43 6	0%	0%			0%	0%	0%	0%	0%	0%	0%	-1%
DUT6	Test43 1	0%	0%			0%	-1%	0%	0%	1%	3%	0%	0%
	Test43 2	0%	0%	0%	-1%	0%	0%	0%	0%	0%	-2%	0%	-1%
	Test43 3	0%	0%			0%	0%	0%	0%	0%	2%	0%	1%
	Test43 4	0%	0%			0%	0%	0%	0%	1%	5%	0%	0%
	Test43 5	0%	0%	0%	-1%	0%	0%	0%	0%	1%	-2%	0%	0%
	Test43 6	0%	0%			0%	0%	0%	0%	1%	1%	0%	0%
DUT7	Test43 1	0%	0%			0%	0%	0%	0%	0%	3%	0%	0%
	Test43 2	0%	0%	0%	-1%	0%	0%	0%	0%	-1%	-3%	0%	4%
	Test43 3	3%	0%			0%	0%	0%	0%	0%	3%	0%	-1%
	Test43 4	0%	0%			0%	0%	0%	0%	0%	3%	0%	-1%
	Test43 5	0%	0%	0%	-1%	0%	0%	0%	0%	2%	-12%	0%	0%
	Test43 6	0%	0%			0%	0%	0%	0%	1%	-5%	0%	0%
DUT8	Test43 1	0%	0%			0%	0%	0%	0%	2%	-1%	0%	-2%
	Test43 2	0%	0%	0%	0%	0%	0%	0%	0%	1%	2%	0%	2%
	Test43 3	0%	0%			0%	0%	0%	0%	0%	8%	0%	1%
	Test43 4	0%	0%			0%	0%	0%	0%	-1%	-4%	0%	1%
	Test43 5	0%	0%	0%	0%	0%	0%	0%	0%	-1%	-3%	0%	1%
	Test43 6	0%	0%			0%	1%	0%	0%	1%	9%	0%	0%

It is worth noting that the ISL70003ASEH survived at operating conditions to PVIN = 16.5V and IOUT = 11A with an LET of 43MeV • cm²/mg.

SEFI Testing of the ISL70003ASEH

One of the noted SEE for the ISL70003SEH was the shutdown and spontaneous restart Single Event Functional Interrupt (SEFI) noted at low supply voltage and high LET (Refer to [AN1913](#)). These events are highlighted by a dropout and recovery of the PGOOD signal. [Table 5](#) presents the SET count statistics for the PGOOD cycling that identify these SEFI for the ISL70003ASEH.

As with the ISL70003SEH, the self-recovering SEFI only occurred at low PVIN of 3V and high LET (86MeV • cm²/mg, Au at zero degrees incidence). At a PVIN of 5.5V and above or at PVIN = 3V

and LET = 58MeV • cm²/mg (PR at zero degrees incidence) there were no SEFI registered to a total of 4x10⁷ion/cm² across the four units tested. Even so, the cross section of these SEFI events calculates to only 6.1x10⁷/cm² at an LET of 86MeV • cm²/mg. At an LET of 58MeV • cm²/mg the nominal SEFI cross section is below 2.5x10⁻⁸/cm². Thus there is the same narrow application space where the ISL70003SEH and ISL70003ASEH are both subject to these low probability self-recovering SEFI.

TABLE 5. ISL70003ASEH SEFI COUNTS BY PGOOD CYCLES FOR VARIOUS OPERATING CONDITIONS. FLUENCE OF 1x10⁷ion/cm² WAS RUN FOR EACH UNIT AT EACH TEST.

LET MeV • cm ² /mg	PVIN (V)	FREQUENCY (kHz)	SEFI COUNTS BY PGOOD CYCLES			
			DUT14	DUT15	DUT16	DUT17
86	3.0	300 internal	6	10	4	4
86	3.0	500 external	6	3	5	11
86	5.5	500 external	0	0	0	0
58	3.0	300 internal	0	0	0	0
			DUT10	DUT11	DUT12	DUT13
86	13.2	300 internal	0	0	0	0
86	13.2	500 external	0	0	0	0

V_{OUT} SET Testing of the ISL70003ASEH

During the same irradiations as used to monitor SEFI, the V_{OUT} was also monitored for SET. Initially a trigger of ±100mV was attempted (DUT10) but that failed to produce any captures so the trigger was reduced to ±50mV. At the ±50mV trigger level the SET counts were quite variable as the trigger straddled the relative maximum of the SET. The SET capture statistics are presented in [Table 6](#). It should be noted that for the low voltage

SET tests (the top four rows of [Table 6](#)) the output inductor was 3.3μH, while for the PVIN = 13.2V tests (the bottom two rows of the table) the inductor was 6.8μH.

TABLE 6. ±50mV TRIGGERED SET COUNTS FOR VARIOUS OPERATING CONDITIONS. FLUENCE OF 1x10⁷ion/cm² WAS RUN FOR EACH UNIT AT EACH TEST.

LET MeV • cm ² /mg	PVIN (V)	V _{OUT} (V)	FREQUENCY (kHz)	±50mV TRIGGER V _{OUT} SET			
				DUT14	DUT15	DUT16	DUT17
86	3.0	1.8	300 internal	128	82	169	192
86	3.0	1.8	500 external	54	2	77	82
86	5.5	1.8	500 external	0	0	0	11
58	3.0	1.8	300 internal	58	2	103	123
				DUT10	DUT11	DUT12	DUT13
86	13.2	3.3	300 internal	0*	501	95	384
86	13.2	3.3	500 external	0*	83	0	128

NOTE: * Indicates a trigger of ±100mV was used. In all cases I_{OUT} = 3A.

The captured transients were post processed with some digital filtering to minimize the switching transient noise and then analyzed to find the largest V_{OUT} SET occurring in each irradiation run. [Figure 3](#) depicts the worst case SET for each of the units tested on the first line of [Table 6](#) $PV_{IN} = 3.0V$, $V_{OUT} = 1.8V$, 300kHz, 86MeV • cm²/mg). In each plot the deviation in percentage of V_{OUT} is accompanied by plots of the switching node, LX, the error amplifier output voltage, VERR and the reference voltage, VREF. Since all the larger SET resulted from missing LX pulses, all the larger SET were negative going transients. All of the SET seem to start with a disruption on VERR. The worst V_{OUT} SET recorded (in 4×10^7 ions/cm² at 86MeV • cm²/mg) was -81mV or about -4.5% of the 1.8V V_{OUT} .

The worst SET captured for each unit tested in the second row of [Table 6](#) (500kHz switching frequency) were marginally smaller than

those of the first row SET with a worst occurrence of -4% or -72mV. In other regards they look as VERR being the initiating SET followed by missing LX pulses and a drop in V_{OUT} just as shown in [Figure 3](#). Since there is no fundamental difference in the SET plots for the second row are not presented.

For the third row of [Table 6](#) ($PV_{IN} = 5.5V$, $V_{OUT} = 1.8V$, 500kHz) only eleven events, all on DUT4, were captured. The largest of these eleven events was -2% deviation or about -36mV. Again a disturbance of VERR preceded a missing LX pulse and resulted in a drop of V_{OUT} . The combination of the higher switching frequency and the larger step-down ratio from $V_{IN} = 5.5V$ to $V_{OUT} = 1.8V$ seems to have resulted in less of a V_{OUT} disturbance for same form of missing pulses as seen in [Figure 3](#).

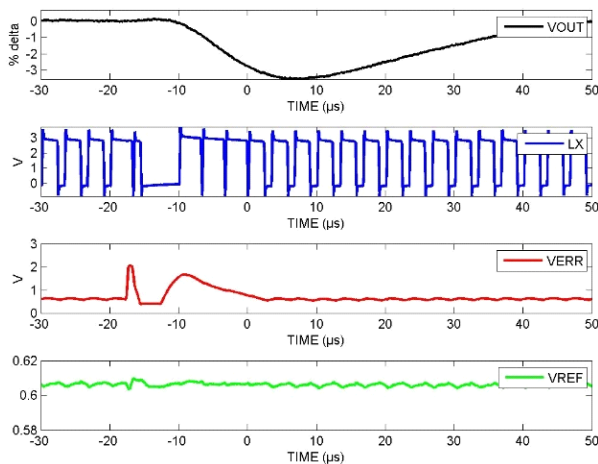

FIGURE 3A.

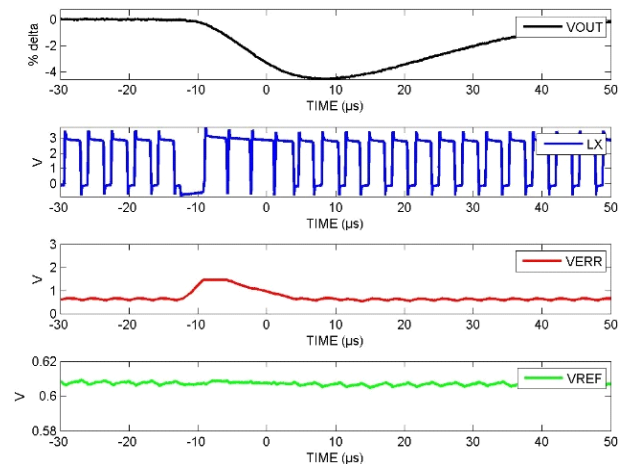

FIGURE 3B.

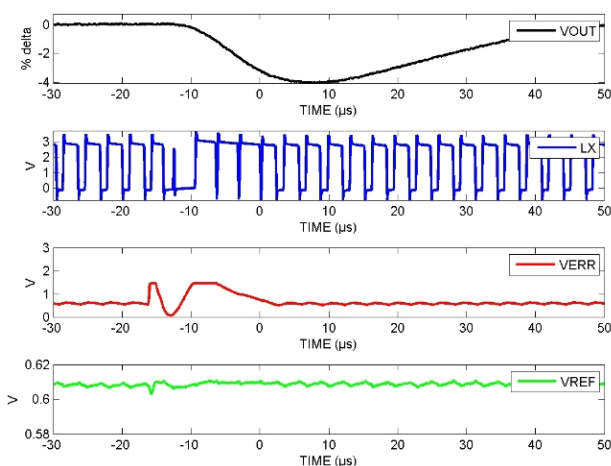

FIGURE 3C.

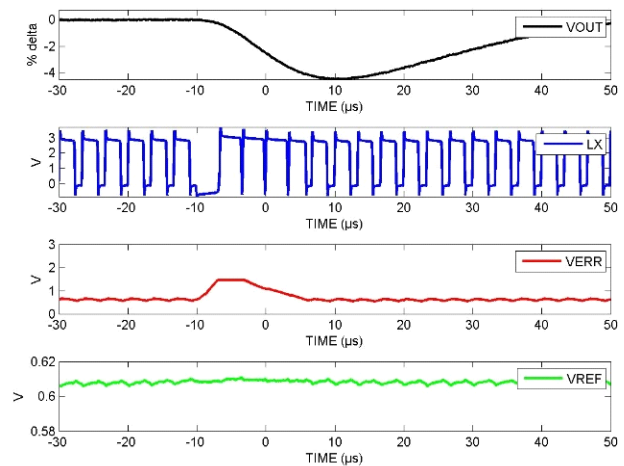

FIGURE 3D.

FIGURE 3. Worst case SET captured for each of the four units tested at $PV_{IN} = 3V$, $V_{OUT} = 1.8V$, $I_{OUT} = 3A$, frequency = 300kHz internal and LET = 86MeV • cm²/mg. Worst case SET was -4.5% or 81mV.

The fourth row of [Table 6](#) (LET = 58MeV • cm²/mg) again generated SET very similar in form to those presented in [Figure 3 on page 7](#). The worst case recorded was -4.1% or -72mV from the nominal V_{OUT} of 1.8V. Again missing LX pulses following a disturbance to VERR were the forms taken.

The fifth row of [Table 6](#) represents SET with V_{IN} = 13.2V and V_{OUT} = 3.3V. For the three units for which SET were recorded, the

largest SET for each unit is presented in [Figure 4](#). The -40mV worst case SET represents only about -1.2% of the larger V_{OUT} = 3.3V than represented in [Figure 3](#). It should also be recalled that the output inductor in this case was 6.8μH, whereas for the earlier cases the inductor was 3.3μH. The combination of the smaller duty cycle and larger inductor led to smaller V_{OUT} disturbance for the same missing LX pulses as seen previously.

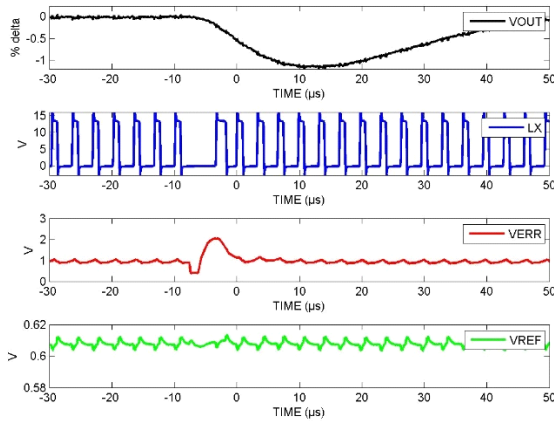

FIGURE 4A.

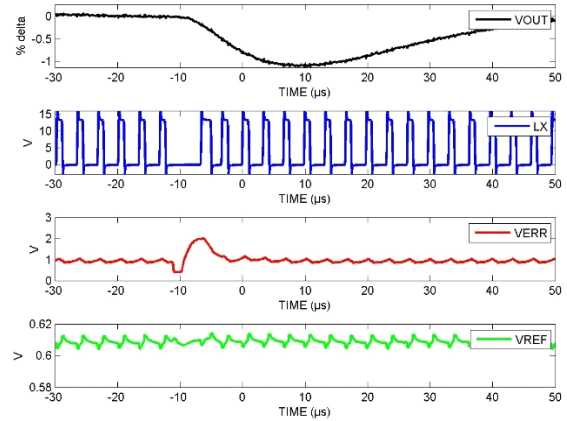

FIGURE 4B.

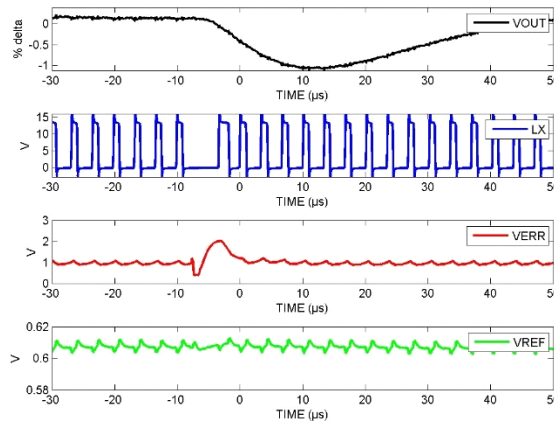

FIGURE 4. Worst case SET captured for each of the three units tested at P_{VIN} = 13.2V, V_{OUT} = 3.3V, I_{OUT} = 3A, frequency = 300kHz internal and LET = 86MeV • cm²/mg. Worst case SET was -1.2% or 40mV.

Interestingly, the sixth row of [Table 6](#) only had SET recorded for two of the three units tested with $\pm 50\text{mV}$ triggering, and the worst case SET for those recorded was -0.6% or about -20mV . The two worst cases are shown in [Figure 5](#) and do not exhibit any missing LX pulses, which leads to the reduced size of the SET. The events still started with a disruption on VERR, but did not result in missing LX pulses. A single shortened pulse seems to be

the hallmark of these events. The higher frequency (500kHz versus 300kHz) may have contributed to somewhat smaller SET than those in [Figure 4](#), but it does not seem to explain why the missing LX pulse events vanished.

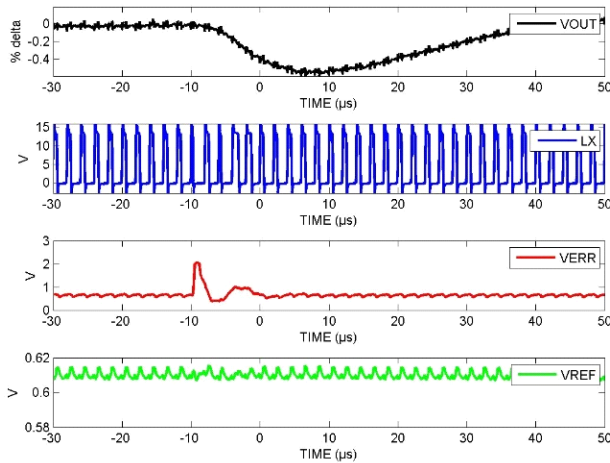

FIGURE 5A.

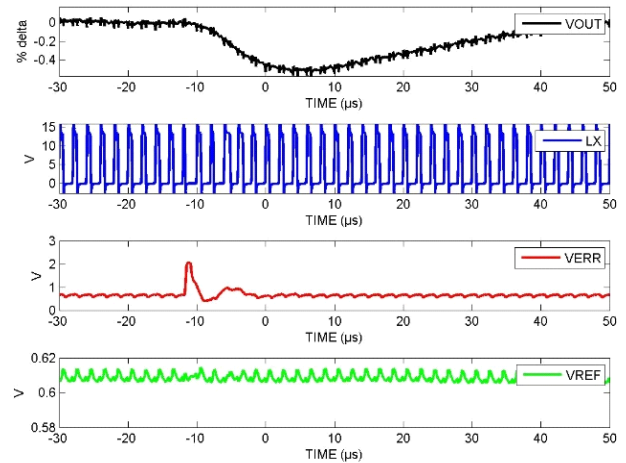

FIGURE 5B.

FIGURE 5. Worst case SET captured for each of the two units tested at $PV_{IN} = 13.2\text{V}$, $V_{OUT} = 3.3\text{V}$, $I_{OUT} = 3\text{A}$, frequency = 500kHz external and $LET = 86\text{MeV}\cdot\text{cm}^2/\text{mg}$. Worst case SET was -0.6% or 20mV .

TABLE 7. SET STATISTICS FOR BUFFER OUTPUT (BUFOUT)

LET MeV·cm ² /mg	PVIN (V)	V _{OUT} (V)	FREQUENCY (kHz)	±40mV TRIGGER BUFOUT SET			
				DUT14	DUT15	DUT16	DUT17
86	3.0	1.8	300 internal	0	0	0	0
86	3.0	1.8	500 external	0	1	0	0
86	5.5	1.8	500 external	52	41	50	19
58	3.0	1.8	300 internal	0	1	0	2
				DUT10	DUT11	DUT12	DUT13
86	13.2	3.3	300 internal	725	616	909	624
86	13.2	3.3	500 external	2008	1464	1873	461

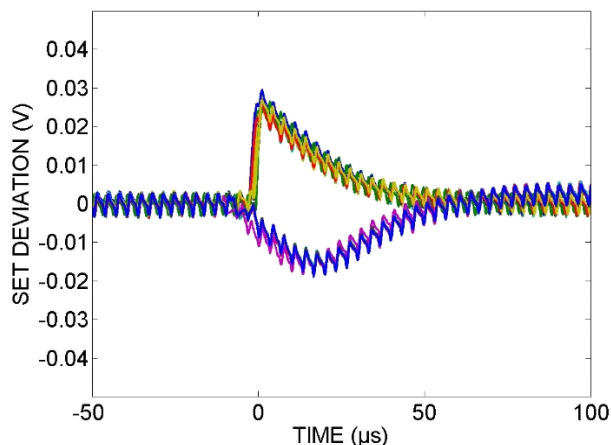

FIGURE 6A.

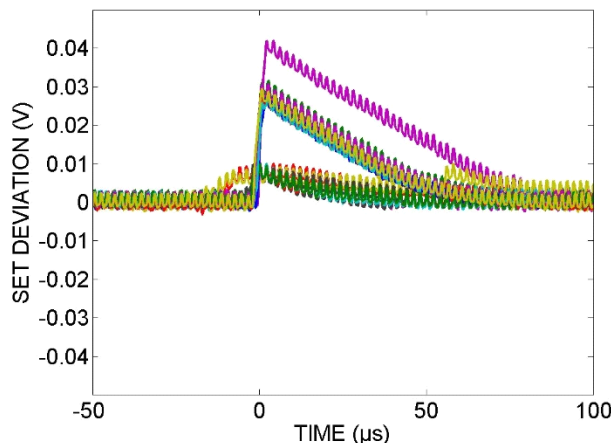

FIGURE 6B.

FIGURE 6. Examples of worst case BUFOUT SET. Plots are composites of the 10 longest and largest for each polarity in the irradiation run. Irradiation was with Au (86MeV • cm²/mg) to 1x10⁷ ion/cm². Left plot is DUT12 AT PVIN = 13.2V and f_{SW} = 300kHz. Right PLOT is DUT13 at PVIN = 13.2V and f_{SW} = 500kHz.

Buffer Output SET of the ISL70003ASEH

While running the V_{OUT} SET tests the Buffer Output (BUFOUT) was also monitored and triggered on SET excursions of more than ±40mV from its DC value. The capture statistics for BUFOUT SET are presented in Table 7. Only the PVIN = 13.2V cases yielded appreciable SET counts, with a few showing up for PVIN = 5.5V. Examples of worst case SET for the PVIN = 13.2V cases are shown in Figure 6.

Of the SET captured, most were positive going SET bounded by +50mV. The lack of SET for PVIN = 3.0V is likely a result of the SET being smaller than the trigger setting and not an indication that SET were not occurring. The higher PVIN levels provided SET

large enough to trigger captures. The SET seem to have decayed in about 80μs from onset. The switching noise on BUFOUT as captured was several millivolts.

IMON SET of the ISL70003ASEH

During the V_{OUT} SET testing the IMON output was also monitored and triggered captures on ±80mV events. Statistics on the IMON SET captures are presented in Table 8 and show a dependence on the LET of the incident ion. LET 58MeV • cm²/mg yielded somewhat lower counts than runs at 86MeV • cm²/mg.

TABLE 8. SET STATISTICS FOR IMON

LET MeV • cm ² /mg	PVIN (V)	V _{OUT} (V)	FREQUENCY (kHz)	±80mV TRIGGER BUFOUT SET			
				DUT14	DUT15	DUT16	DUT17
86	3.0	1.8	300 internal	1009	1350	1159	1070
86	3.0	1.8	500 external	1222	1038	1261	1198
86	5.5	1.8	500 external	1521	1203	1502	1648
58	3.0	1.8	300 internal	389	373	867	768
				DUT10	DUT11	DUT12	DUT13
86	13.2	3.3	300 internal	1898	615*	1441	1672
86	13.2	3.3	500 external	2343	800*	1887	1896

NOTE: * Indicates a trigger of 120mV setting.

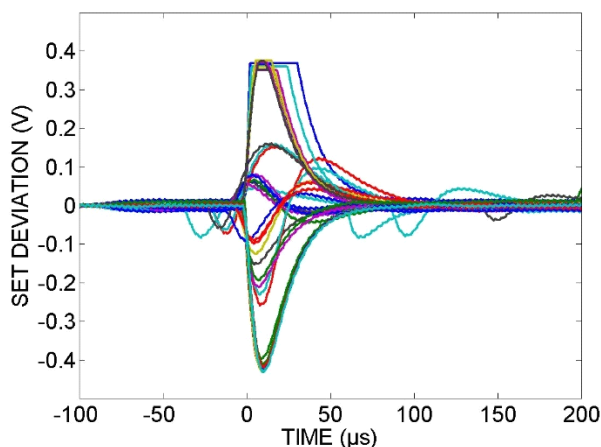

FIGURE 7A.

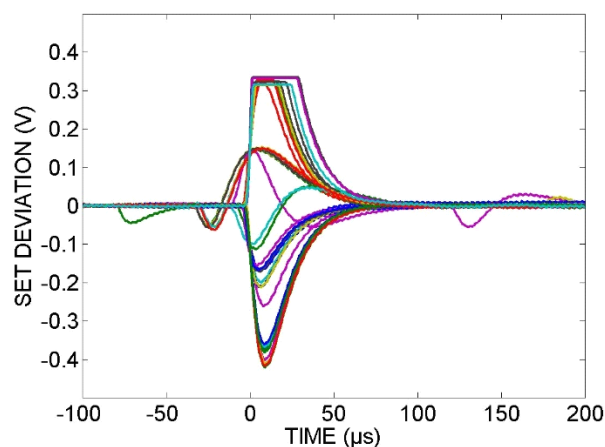

FIGURE 7B.

FIGURE 7. Examples of worst case IMON SET. Plots are composites of the 10 longest and largest for each polarity in the irradiation run. Irradiation was with Au ($86\text{MeV} \cdot \text{cm}^2/\text{mg}$) to 1×10^7 ion/ cm^2 . The plots are for DUT10 and DUY11 at $\text{PVIN} = 13.2\text{V}$ and $f_{\text{SW}} = 300\text{kHz}$. The oscilloscope setting LED to the clipping of the positive going SET.

Examples of the IMON SET are presented in [Figure 7](#) and show both positive and negative excursions on the IMON voltage.

The negative going IMON SET were limited to about 400mV, but the positive going SET seem to extrapolate to something more like 1V. Significant disturbance seems to have about a 100 μs duration.

Conclusion

Non Damaging SEE

Four ISL70003ASEH parts survived the same SEE qualification testing as was done on the ISL70003SEH. This testing consisted of irradiation with gold at normal incidence for an LET of $86\text{MeV} \cdot \text{cm}^2/\text{mg}$ to a fluence 5×10^6 ions/ cm^2 on each run. Runs were done with conditions: disabled with $\text{PVIN} = 14.7\text{V}$, sourcing 7A at 3.3V with $\text{PVIN} = 14.7\text{V}$ and sinking 4A at 3.3V with $\text{PVIN} = 13.7\text{V}$. All of this was done at a case temperature of $+125^\circ\text{C} \pm 10^\circ\text{C}$.

In addition to the above testing, the parts survived irradiation while sourcing 11A at 3.3V with $\text{PVIN} = 14.7\text{V}$. For operation at this higher current level, the Schottky diode from GND to LX was installed on the boards. The parts also survived operation under beam with $\text{PVIN} = 15.5\text{V}$ and $I_{\text{OUT}} = 11\text{A}$, but this goes beyond the performance previously seen on the ISL70003SEH.

In a separate set of tests four parts were irradiated with silver for an LET of $43\text{MeV} \cdot \text{cm}^2/\text{mg}$ to 1×10^7 ions/ cm^2 . During the irradiations the parts were operated at $V_{\text{OUT}} = 3.3\text{V}$ with $\text{PVIN} = 16.5\text{V}$, $I_{\text{OUT}} = 11\text{A}$ and with $\text{PVIN} = 15.5\text{V}$, $I_{\text{OUT}} = -4\text{A}$.

Single Event Transients

The ISL70003ASEH was subjected to the SET conditions used to characterize the ISL70003SEH. Since the changes between the parts were not anticipated to modify SET behavior, the objective was to demonstrate comparable behavior.

Comparable performance was observed for the spontaneous recovery SEFI at low PVIN (3V) and high LET ($86\text{MeV} \cdot \text{cm}^2/\text{mg}$). The SEFI exhibited a cross section of $6.1 \times 10^{-7}/\text{cm}^2$ at those conditions and disappeared completely for either $\text{PVIN} = 5.5\text{V}$ or LET of $60\text{MeV} \cdot \text{cm}^2/\text{mg}$.

With an output LC of 3.3 μH and 150 μF operating from $\text{PVIN} = 3.0\text{V}$ at 300kHz, the worst case SET was a drop of 4.5% (81mV) on the 1.8V output. This was in response to gold at zero incidence for an LET of $86\text{MeV} \cdot \text{cm}^2/\text{mg}$.

For operation from $\text{PVIN} = 13.2\text{V}$ with an inductor of 6.8 μH and output of 3.3V at 500kHz, the worst case V_{OUT} SET observed was -1.2% drop.

This is all consistent with the behavior observed for the ISL70003SEH ([AN1913](#)).

Notice

1. Descriptions of circuits, software and other related information in this document are provided only to illustrate the operation of semiconductor products and application examples. You are fully responsible for the incorporation or any other use of the circuits, software, and information in the design of your product or system. Renesas Electronics disclaims any and all liability for any losses and damages incurred by you or third parties arising from the use of these circuits, software, or information.
2. Renesas Electronics hereby expressly disclaims any warranties against and liability for infringement or any other claims involving patents, copyrights, or other intellectual property rights of third parties, by or arising from the use of Renesas Electronics products or technical information described in this document, including but not limited to, the product data, drawings, charts, programs, algorithms, and application examples.
3. No license, express, implied or otherwise, is granted hereby under any patents, copyrights or other intellectual property rights of Renesas Electronics or others.
4. You shall not alter, modify, copy, or reverse engineer any Renesas Electronics product, whether in whole or in part. Renesas Electronics disclaims any and all liability for any losses or damages incurred by you or third parties arising from such alteration, modification, copying or reverse engineering.
5. Renesas Electronics products are classified according to the following two quality grades: "Standard" and "High Quality". The intended applications for each Renesas Electronics product depends on the product's quality grade, as indicated below.
"Standard": Computers; office equipment; communications equipment; test and measurement equipment; audio and visual equipment; home electronic appliances; machine tools; personal electronic equipment; industrial robots; etc.
"High Quality": Transportation equipment (automobiles, trains, ships, etc.); traffic control (traffic lights); large-scale communication equipment; key financial terminal systems; safety control equipment; etc.
Unless expressly designated as a high reliability product or a product for harsh environments in a Renesas Electronics data sheet or other Renesas Electronics document, Renesas Electronics products are not intended or authorized for use in products or systems that may pose a direct threat to human life or bodily injury (artificial life support devices or systems; surgical implantations; etc.), or may cause serious property damage (space system; undersea repeaters; nuclear power control systems; aircraft control systems; key plant systems; military equipment; etc.). Renesas Electronics disclaims any and all liability for any damages or losses incurred by you or any third parties arising from the use of any Renesas Electronics product that is inconsistent with any Renesas Electronics data sheet, user's manual or other Renesas Electronics document.
6. When using Renesas Electronics products, refer to the latest product information (data sheets, user's manuals, application notes, "General Notes for Handling and Using Semiconductor Devices" in the reliability handbook, etc.), and ensure that usage conditions are within the ranges specified by Renesas Electronics with respect to maximum ratings, operating power supply voltage range, heat dissipation characteristics, installation, etc. Renesas Electronics disclaims any and all liability for any malfunctions, failure or accident arising out of the use of Renesas Electronics products outside of such specified ranges.
7. Although Renesas Electronics endeavors to improve the quality and reliability of Renesas Electronics products, semiconductor products have specific characteristics, such as the occurrence of failure at a certain rate and malfunctions under certain use conditions. Unless designated as a high reliability product or a product for harsh environments in a Renesas Electronics data sheet or other Renesas Electronics document, Renesas Electronics products are not subject to radiation resistance design. You are responsible for implementing safety measures to guard against the possibility of bodily injury, injury or damage caused by fire, and/or danger to the public in the event of a failure or malfunction of Renesas Electronics products, such as safety design for hardware and software, including but not limited to redundancy, fire control and malfunction prevention, appropriate treatment for aging degradation or any other appropriate measures. Because the evaluation of microcomputer software alone is very difficult and impractical, you are responsible for evaluating the safety of the final products or systems manufactured by you.
8. Please contact a Renesas Electronics sales office for details as to environmental matters such as the environmental compatibility of each Renesas Electronics product. You are responsible for carefully and sufficiently investigating applicable laws and regulations that regulate the inclusion or use of controlled substances, including without limitation, the EU RoHS Directive, and using Renesas Electronics products in compliance with all these applicable laws and regulations. Renesas Electronics disclaims any and all liability for damages or losses occurring as a result of your noncompliance with applicable laws and regulations.
9. Renesas Electronics products and technologies shall not be used for or incorporated into any products or systems whose manufacture, use, or sale is prohibited under any applicable domestic or foreign laws or regulations. You shall comply with any applicable export control laws and regulations promulgated and administered by the governments of any countries asserting jurisdiction over the parties or transactions.
10. It is the responsibility of the buyer or distributor of Renesas Electronics products, or any other party who distributes, disposes of, or otherwise sells or transfers the product to a third party, to notify such third party in advance of the contents and conditions set forth in this document.
11. This document shall not be reprinted, reproduced or duplicated in any form, in whole or in part, without prior written consent of Renesas Electronics.
12. Please contact a Renesas Electronics sales office if you have any questions regarding the information contained in this document or Renesas Electronics products.
(Note 1) "Renesas Electronics" as used in this document means Renesas Electronics Corporation and also includes its directly or indirectly controlled subsidiaries.
(Note 2) "Renesas Electronics product(s)" means any product developed or manufactured by or for Renesas Electronics.

(Rev.4.0-1 November 2017)



SALES OFFICES

Renesas Electronics Corporation

<http://www.renesas.com>

Refer to "<http://www.renesas.com/>" for the latest and detailed information.

Renesas Electronics America Inc.
1001 Murphy Ranch Road, Milpitas, CA 95035, U.S.A.
Tel: +1-408-432-8888, Fax: +1-408-434-5351

Renesas Electronics Canada Limited
9251 Yonge Street, Suite 8309 Richmond Hill, Ontario Canada L4C 9T3
Tel: +1-905-237-2004

Renesas Electronics Europe Limited
Dukes Meadow, Millboard Road, Bourne End, Buckinghamshire, SL8 5FH, U.K
Tel: +44-1628-651-700, Fax: +44-1628-651-804

Renesas Electronics Europe GmbH
Arcadiastrasse 10, 40472 Düsseldorf, Germany
Tel: +49-211-6503-0, Fax: +49-211-6503-1327

Renesas Electronics (China) Co., Ltd.
Room 1709 Quantum Plaza, No.27 ZhichunLu, Haidian District, Beijing, 100191 P. R. China
Tel: +86-10-8235-1155, Fax: +86-10-8235-7679

Renesas Electronics (Shanghai) Co., Ltd.
Unit 301, Tower A, Central Towers, 555 Langao Road, Putuo District, Shanghai, 200333 P. R. China
Tel: +86-21-2226-0888, Fax: +86-21-2226-0999

Renesas Electronics Hong Kong Limited
Unit 1601-1611, 16/F., Tower 2, Grand Century Place, 193 Prince Edward Road West, Mongkok, Kowloon, Hong Kong
Tel: +852-2265-6688, Fax: +852-2886-9022

Renesas Electronics Taiwan Co., Ltd.
13F, No. 363, Fu Shing North Road, Taipei 10543, Taiwan
Tel: +886-2-8175-9600, Fax: +886-2-8175-9670

Renesas Electronics Singapore Pte. Ltd.
80 Bendemeer Road, Unit #06-02 Hyflux Innovation Centre, Singapore 339949
Tel: +65-6213-0200, Fax: +65-6213-0300

Renesas Electronics Malaysia Sdn.Bhd.
Unit 1207, Block B, Menara Amcorp, Amcorp Trade Centre, No. 18, Jln Persiaran Barat, 46050 Petaling Jaya, Selangor Darul Ehsan, Malaysia
Tel: +60-3-7955-9390, Fax: +60-3-7955-9510

Renesas Electronics India Pvt. Ltd.
No.777C, 100 Feet Road, HAL 2nd Stage, Indiranagar, Bangalore 560 038, India
Tel: +91-80-67208700, Fax: +91-80-67208777

Renesas Electronics Korea Co., Ltd.
17F, KAMCO Yangjae Tower, 262, Gangnam-daero, Gangnam-gu, Seoul, 06265 Korea
Tel: +82-2-558-3737, Fax: +82-2-558-5338