ISL70227SEH, ISL70227SRH

Single Event Effects Testing of the ISL70227SxH, Dual 36V Rad Hard Precision Operation Amplifiers

Introduction

The intense heavy ion environment encountered in space applications can cause a variety of transient and destructive effects in analog circuits, including single-event latch-up (SEL), single-event transients (SET), and single-event burnout (SEB). These effects can lead to system-level failures including disruption and permanent damage. For predictable and reliable system operation, these components have to be formally designed and fabricated for SEE hardness, followed by a detailed SEE testing to validate the design. This report discusses the results of SEE testing for the ISL70227SxH (ISL70227SEH, ISL70227SRH).

Product Description

The ISL70227SxH is a low noise 10MHz BW high precision, dual operational amplifier featuring very low input bias current and low offset voltage with low temperature drift. A super-beta NPN input stage with input bias current cancellation provides low input bias current and low input offset voltage while a complimentary bipolar output stage enables high capacitive load drive without external compensation. These features plus its radiation tolerance make the ISL70227SxH the ideal choice for applications requiring both high DC accuracy and AC performance.

The ISL70227SxH is implemented in an advanced bonded wafer SOI process using deep trench isolation, resulting in a fully isolated structure. This choice of process technology also results in latch-up free performance, whether electrically or single event induced (SEL).

This amplifier is designed to operate over a wide supply range of 4.5V to 36V. Applications for these amplifiers include precision active filters, low noise front ends, loop filters, data acquisition, and charge amplifiers.

The part is packaged in a 10 lead hermetic ceramic flat pack and operates over the extended temperature range of -55°C to +125°C. A summary of key full temperature range specifications follows:

- Input Offset Voltage: 100μV, max.
- Offset Voltage Drift: 1μV/°C, max.
- Input Offset Current: 12nA, max.
- Input Bias Current: 12nA, max.
- Supply Current/Amplifier: 3.7mA, max.
- Gain Bandwidth Product: 10MHz, typical

Contents

1. SEE Testing	3
1.1 Objective	3
2. Facility	3
3. Procedure	3
3.1 SEE Test Setup Diagrams	3
3.2 Cross-Section Calculation	4
4. Single Event Latch-Up and Burnout Results	4
5. Single Event Transient Testing	4
5.1 Test Method	4
5.2 Cross Section Results	5
5.3 Single Event Transient Response	7
5.3.1 Typical SET Captures	7
6. Summary	13
6.1 Single Event Burnout/Latch-up	13
6.2 Single Event Transient	13
7. Revision History	15

1. SEE Testing

1.1 Objective

The objectives of SEE testing on the ISL70227SxH were to evaluate its susceptibility to single event latch-up and single event burnout and determine its SET behavior.

2. Facility

Testing was performed at the Texas A&M University (TAMU) Cyclotron Institute heavy ion facility. This facility is coupled to a K500 super-conducting cyclotron, which is capable of generating a wide range of test particles with the various energy, flux and fluence levels needed for advanced radiation testing.

3. Procedure

The part was tested for single event latch-up and burnout, using Au ions ($LET = 86.4 \text{ MeV} \cdot \text{cm}^2/\text{mg}$) with a case temperature of 125°C and single event transient characterized using Ne, Ar, and Kr ions with a case temperature of 25°C .

The device under test (DUT) was mounted in the beam line and irradiated with heavy ions of the appropriate species. The parts were assembled in 10 lead dual in-line packages with the metal lid removed for beam exposure. The beam was directed onto the exposed die and the beam flux, beam fluence and errors in the device outputs were measured.

The tests were controlled remotely from the control room. All input power was supplied from portable power supplies connected via cable to the DUT. The supply currents were monitored along with the device outputs. All currents were measured with digital ammeters, while all the output waveforms were monitored on a digital oscilloscope for ease of identifying the different types of SEE, which the part displayed. Events were captured by triggering on changes in the output.

3.1 SEE Test Setup Diagrams

A schematic of the evaluation board is shown in [Figure 1](#).

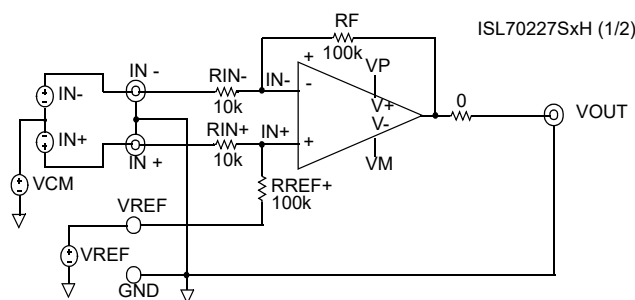

Figure 1. ISL70227SxH SEE Test Schematic

Each operational amplifier was set up in a non-inverting operation with $G = 10\text{V/V}$. The IN- inputs were grounded and the input signal was applied to the IN+ pin.

3.2 Cross-Section Calculation

Cross sections (CS) are calculated as shown by [Equation 1](#):

$$(EQ. 1) \quad CS(LET) = N/F$$

where:

- CS is the SET cross section (cm^2), expressed as a function of the heavy ion LET.
- LET is the linear energy transfer in $\text{MeV}\cdot\text{cm}^2/\text{mg}$, corrected according to the incident angle, if any.
- N is the total number of SET events.
- F is fluence in particles/ cm^2 , corrected according to the incident angle, if any.

A value of 1/F is the assumed cross section when no event is observed.

4. Single Event Latch-Up and Burnout Results

The first testing sequence looked at destructive effects due to burnout or latch-up. A burnout condition is indicated by a permanent change in the device supply current after application of the beam. If the increased current is reset by cycling power, it is termed a latch-up. No burnout or latch-up was observed using Au ions ($\text{LET} = 86.4\text{MeV}\cdot\text{cm}^2/\text{mg}$) at 0° incidence from the perpendicular. Testing was performed on four parts at $+125^\circ\text{C}$ (case temperature) and up to the maximum voltage, $V_S = \pm 18.2\text{V}$. The first three parts (part ID 1, 2 & 3) commenced testing with $V_S = \pm 15\text{V}$ and on subsequent tests V_S voltage was increased to $\pm 17.5\text{V}$ and then $\pm 18.2\text{V}$. The last parts were tested with a V_S of $\pm 17.5\text{V}$ and $\pm 18.2\text{V}$. All test runs were run to a fluence of $2 \times 10^6/\text{cm}^2$. A power supply applied a DC voltage of 200mV to the non-inverting inputs of the amplifiers during the test. Functionality of all outputs was verified after exposure. I_{DD} and I_{EE} were recorded pre and post exposure, with 5% resolution.

Results are shown in [Table 1](#) for the 36.4V total supply voltage.

Table 1. ISL70227SxH Details of SEB/L Tests for $V_S = \pm 18.2\text{V}$ and $\text{LET} = 86.4\text{MeV}\cdot\text{cm}^2/\text{mg}$

Temp (°C)	LET (MeV·cm ² /mg)	Supply Current Pre-Exposure (mA)	Supply Current Post-Exposure (mA)	Latch Events	Cumulative Fluence (Particles/cm ²)	Cumulative Cross Section (cm ²)	Device ID	SEB/L
+125	86	10.6	10.6	0	2.0×10^6	5.0×10^{-7}	1	PASS
+125	86	10.8	10.8	0	2.0×10^6	5.0×10^{-7}	2	PASS
+125	86	11.0	11.0	0	2.0×10^6	5.0×10^{-7}	3	PASS
+125	86	10.7	10.7	0	2.0×10^6	5.0×10^{-7}	4	PASS
Total Events				0				
Overall Fluence					8.0×10^6			
Overall CS						1.25×10^{-7}		
Total Units							4	

5. Single Event Transient Testing

5.1 Test Method

Biasing used for SET test runs was $V_S = \pm 4.5\text{V}$ and $\pm 18\text{V}$. Similar to SEL/B testing, a DC voltage of 200mV was applied to the non-inverting inputs of the amplifiers. Signals from the switch board in the control room were connected to two LECROY oscilloscopes: one set to capture transients due to the output of Channel A and the other to capture transients on the output of Channel B.

SET events are recorded when movement on output during beam exposure exceeds the set window trigger of $\pm 100\text{mV}$. Summary of the scope settings are:

- Scope 1 is set to trigger on Channel 1 to a OUTA window of $\pm 100\text{mV}$. Measurements on Scope 1 are:
 - CH1 = OUTA 200mV/div, CH2 = OUTB 500mV/div
 - CH3 = OUT 200mV/div, CH4 = OUT5 500mV/div
- Scope 2 is set to trigger on Channel 3 to a OUTB window of $\pm 80\text{mV}$. Measurements on Scope 1 are:
 - CH1 = OUTA 200mV/div, CH2 = OUTA 500mV/div
 - CH3 = OUTB 200mV/div, CH4 = OUT5 500mV/div.

The switch board at the end of the 20-ft cabling was found to require terminations of 10nF to keep the noise on the waveforms to a minimum.

5.2 Cross Section Results

Compared to other Renesas radiation tolerant circuits, the ISL70227SxH was not designed for single event transient mitigation. The best approach to characterize the single event transient response is to represent the data on a LET threshold plot.

Figure 2 shows the cross section of the IC versus the LET level, at $V_S = \pm 4.5\text{V}$ and $\pm 18\text{V}$. It can be seen that for an $\text{LET} < 5.4\text{MeV}\cdot\text{cm}^2/\text{mg}$, the cross section is nearly the same independent of supply voltage. As the linear energy transfer increases, there is noticeable increase in cross section area with a lower supply voltage. Data from Figure 2 is represented in Table 2.

Figure 3 to Figure 6 show the cross section of each channel independently at $V_S = \pm 4.5\text{V}$ and $\pm 18\text{V}$ with confidence interval bars for a 90% confidence level.

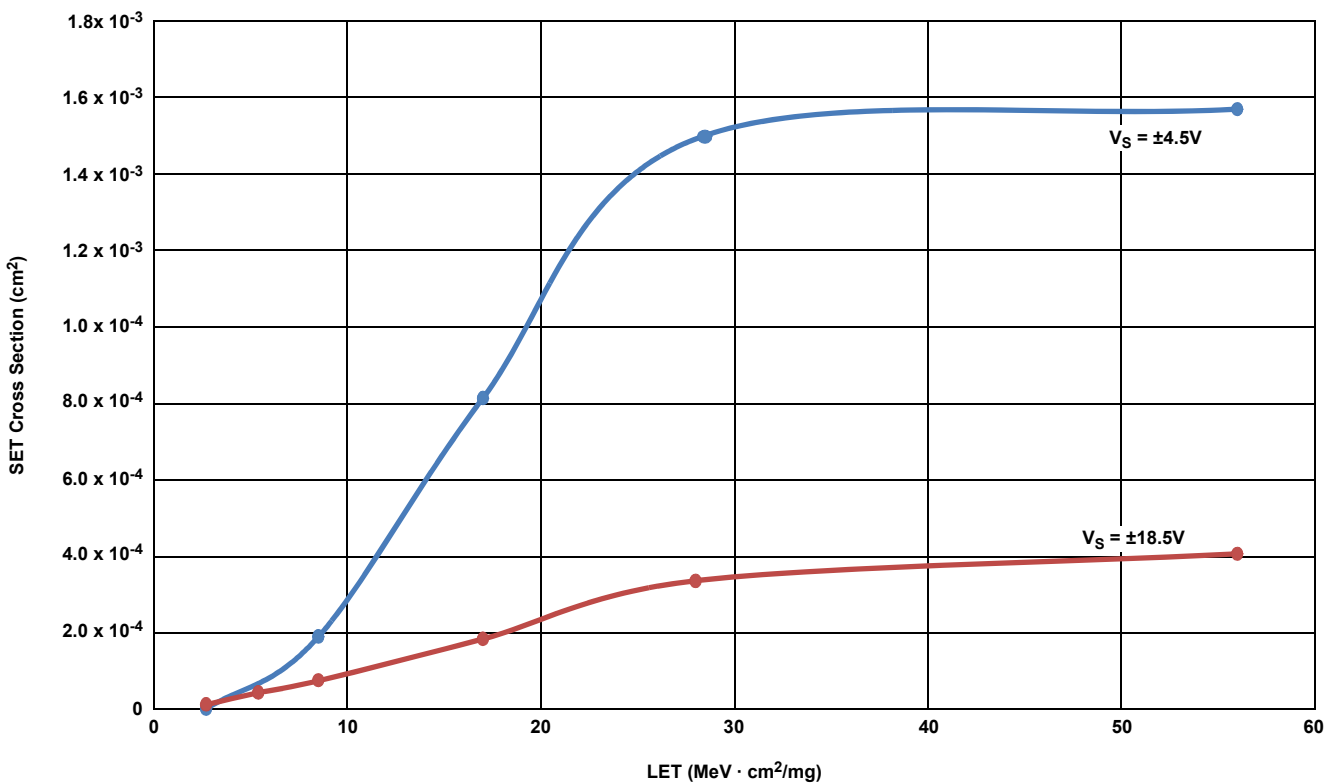

Figure 2. SET Cross Section vs Linear Energy Transfer vs Supply Voltage

Table 2. Details of the Set Cross Section of the ISL70227SxH vs LET vs Supply Voltage

Supply Voltage (V)	ION	Angle (°)	EFF LET (MeV·cm ² /mg)	Fluence per Run (Particles/cm ²)	Number of Runs	Total Set	Event CS cm ²
±4.5V	Ne	0	2.7	2.0 x 10 ⁶	4	18	2.25 x 10 ⁻⁶
	Ar	0	8	2.0 x 10 ⁶	3	1146	1.91 x 10 ⁻⁴
	Ar	60	17	2.0 x 10 ⁶	4	6514	8.14 x 10 ⁻⁴
	Kr	0	28	1.0 x 10 ⁶	4	5968	1.49 x 10 ⁻³
	Kr	60	56	1.0 x 10 ⁶	4	6276	1.57 x 10 ⁻³
±18V	Ne	0	2.7	2.0 x 10 ⁶	4	111	1.39 x 10 ⁻⁶
	Ne	60	5.4	2.0 x 10 ⁶	4	362	4.53 x 10 ⁻⁶
	Ar	0	8	2.0 x 10 ⁶	4	614	7.68 x 10 ⁻⁶
	Ar	60	17	2.0 x 10 ⁶	4	1478	1.85 x 10 ⁻⁵
	Kr	0	28	2.0 x 10 ⁶	4	2695	3.37 x 10 ⁻⁴
	Kr	60	56	2.0 x 10 ⁶	4	3260	4.08 x 10 ⁻⁴

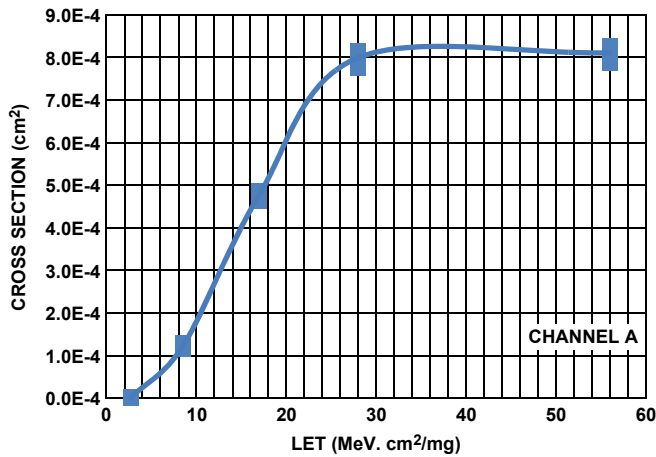

Figure 3. Channel A SET Cross Section vs LET for V_S = ±4.5V with 90% Confidence Level Interval Bars

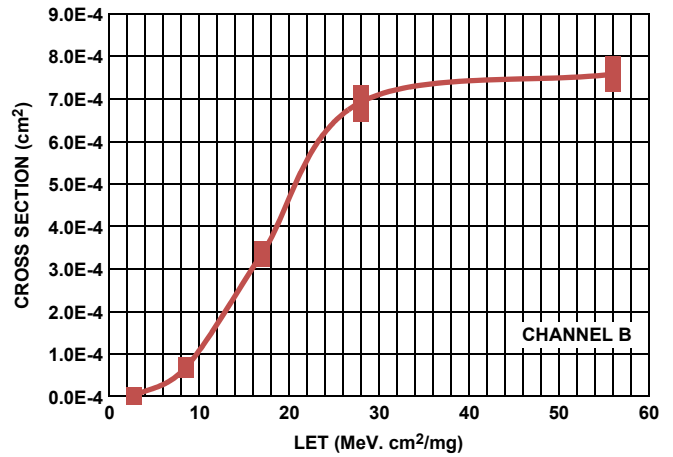

Figure 4. Channel B SET Cross Section vs LET for V_S = ±4.5V with 90% Confidence Level Interval Bars

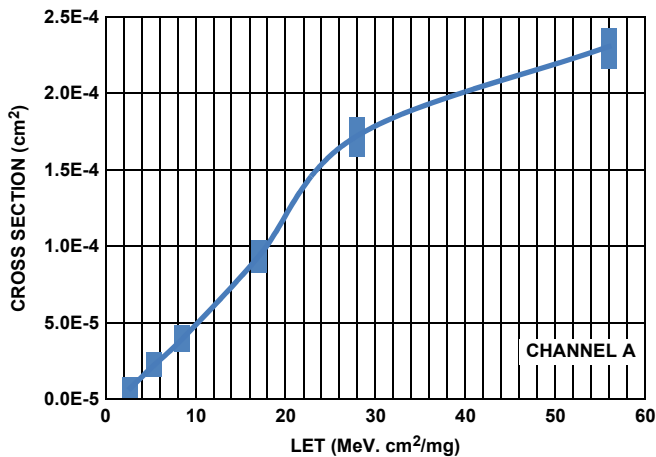

Figure 5. Channel A SET Cross Section vs LET for $V_S = \pm 18V$ with 90% Confidence Level Interval Bars

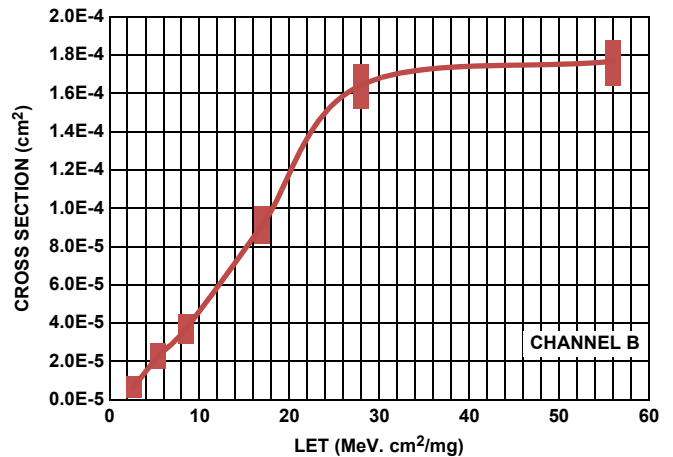

Figure 6. Channel B SET Cross Section vs LET for $V_S = \pm 18V$ with 90% Confidence Level Interval Bars

5.3 Single Event Transient Response

The ISL70227SxH exhibited large single event transients compared to the ISL70218SRH^[1]. Surprisingly, the duration of all the transients were less than 100 μ s, with the majority of the transients lasting less than 50 μ s. Figure 7 to Figure 28 represent output waveforms of each channel of the amplifier under test at various bias conditions and LET values. The plots are composites of the first 50 transients captured on the scope. This information is useful in quantifying the excursion of the output as a result of SEE induced transients.

5.3.1 Typical SET Captures

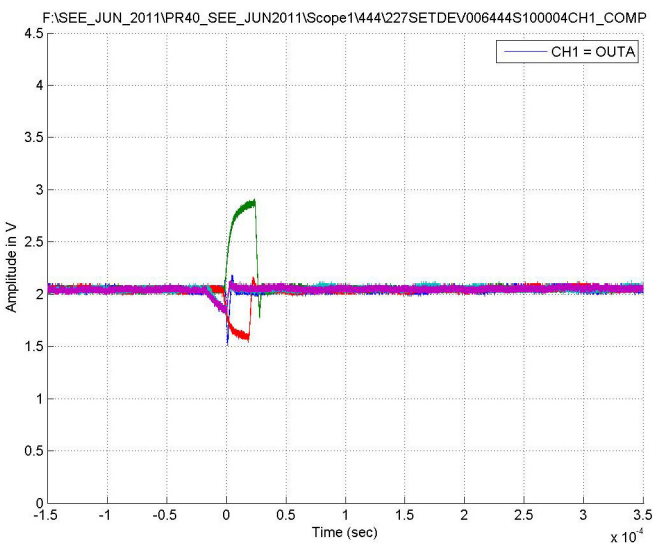

Figure 7. Typical Capture at $V_S = \pm 4.5V$, Channel A, $LET = 2.7MeV \cdot cm^2/mg$, Run 445

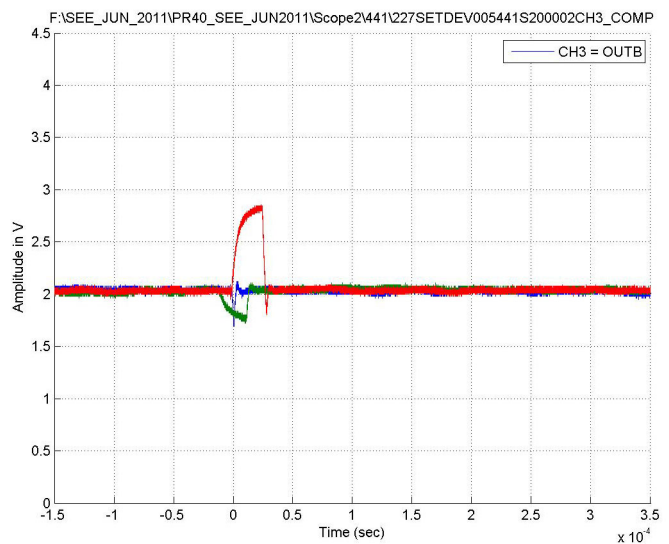

Figure 8. Typical Capture at $V_S = \pm 4.5V$, Channel B, $LET = 2.7MeV \cdot cm^2/mg$, Run 441

1. Oscar Mansilla, Richard Hood, Lawrence Pearce, Eric Thomson and Nick Vanvonno, *Single Event Effects Testing of the ISL70218SRH, Dual 36V Rad Hard Low Power Operation Amplifiers*.

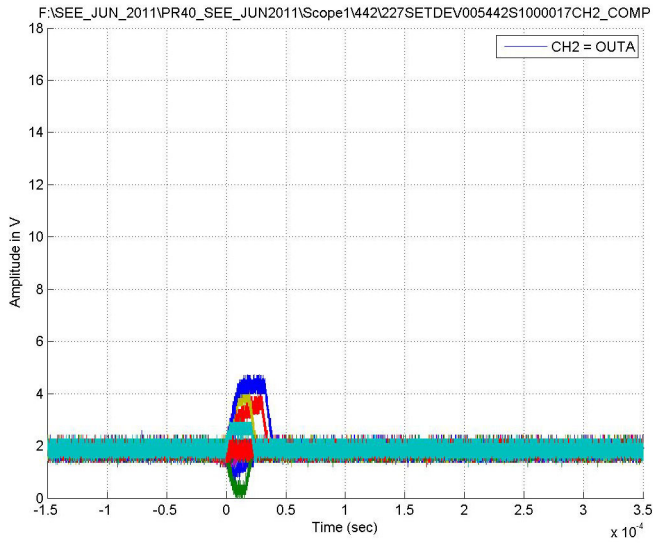

Figure 9. Typical Capture at $V_S = \pm 18V$, Channel A, LET = 2.7MeV·cm²/mg, Run 442

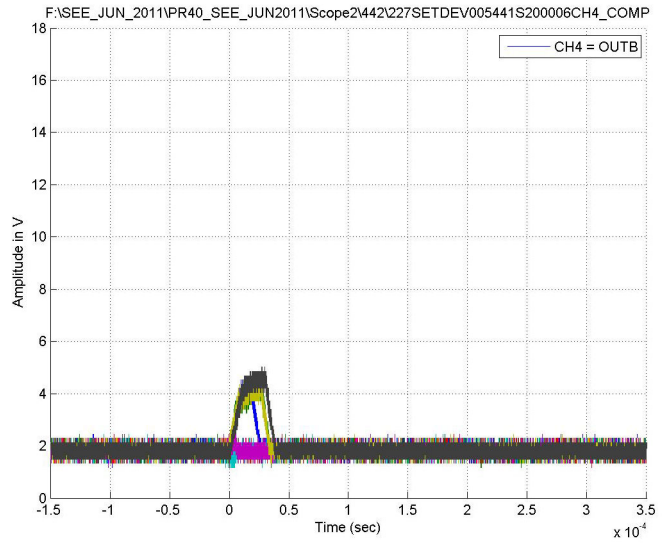

Figure 10. Typical Capture at $V_S = \pm 18V$, Channel B, LET = 2.7MeV·cm²/mg, Run 433

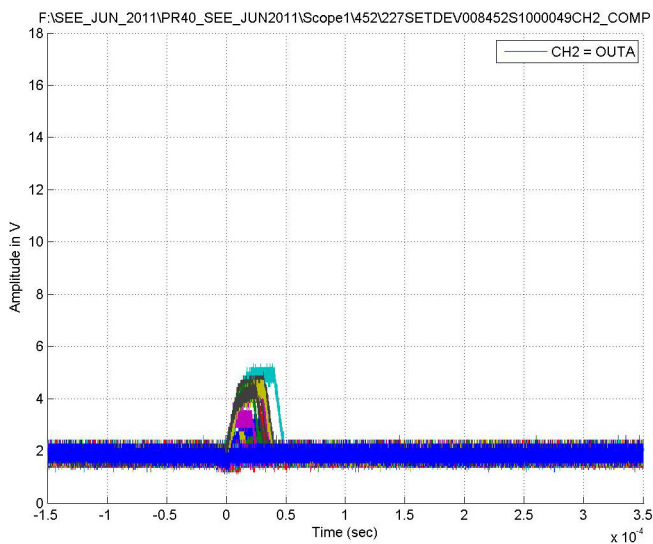

Figure 11. Typical Capture at $V_S = \pm 18V$, Channel A, LET = 5.4MeV·cm²/mg, Run 452

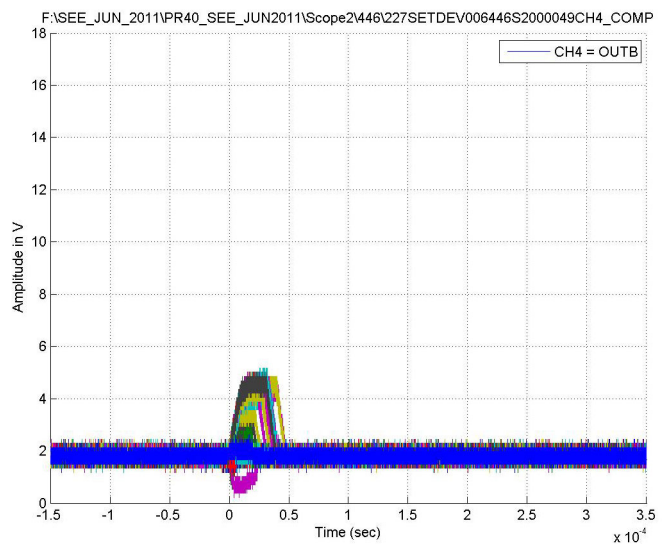

Figure 12. Typical Capture at $V_S = \pm 18V$, Channel B, LET = 5.4MeV·cm²/mg, Run 446

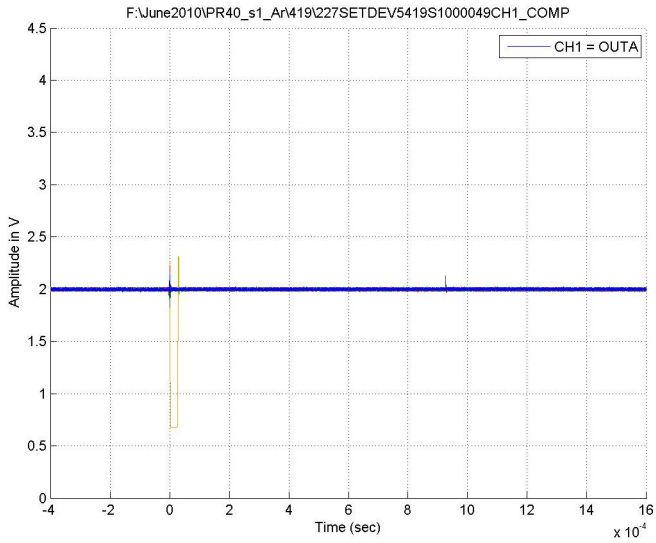

Figure 13. Typical Capture at $V_S = \pm 4.5V$, Channel A, $LET = 8.5MeV \cdot cm^2/mg$, Run 419

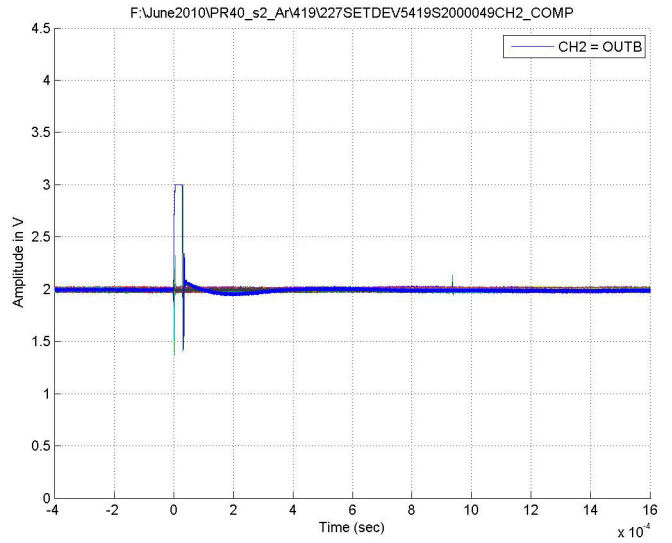

Figure 14. Typical Capture at $V_S = \pm 4.5V$, Channel B, $LET = 8.5MeV \cdot cm^2/mg$, Run 419

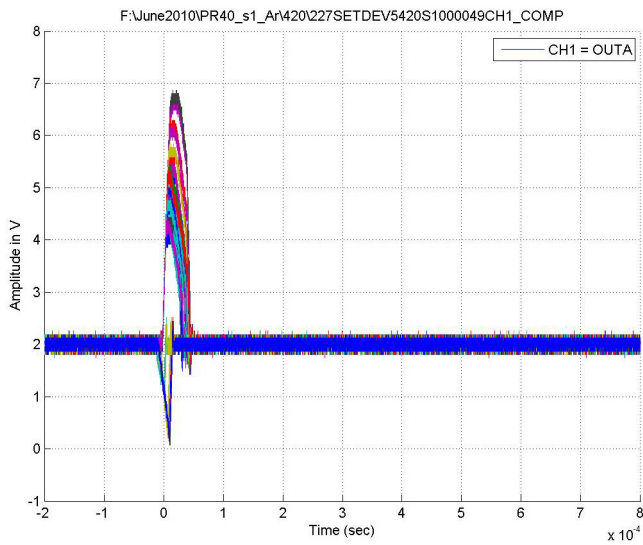

Figure 15. Typical Capture at $V_S = \pm 18V$, Channel A, $LET = 8.5MeV \cdot cm^2/mg^2$, Run 420

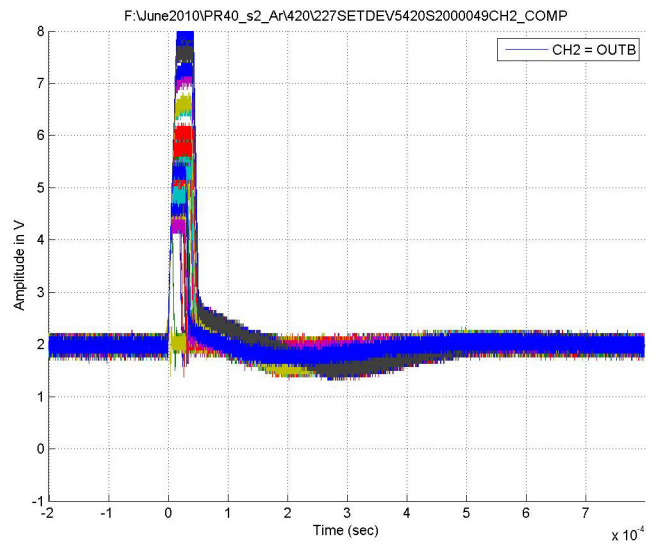

Figure 16. Typical Capture at $V_S = \pm 18V$, Channel B, $LET = 8.5MeV \cdot cm^2/mg$, Run 420

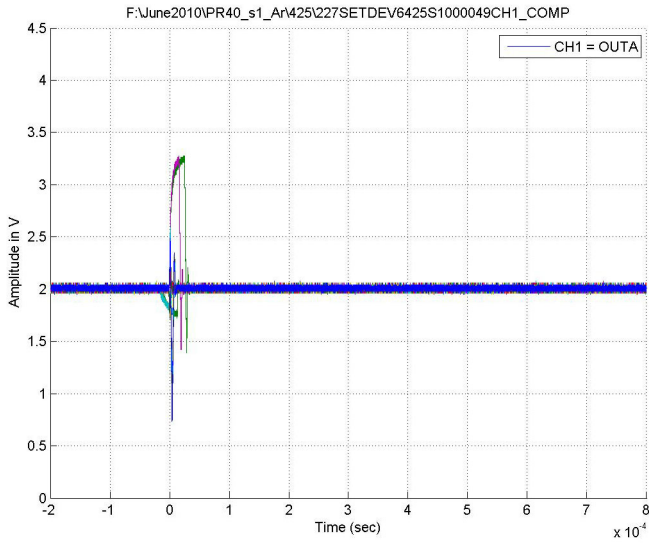

Figure 17. Typical Capture at $V_S = \pm 4.5V$, Channel A, LET = $17MeV \cdot cm^2/mg$, Run 425

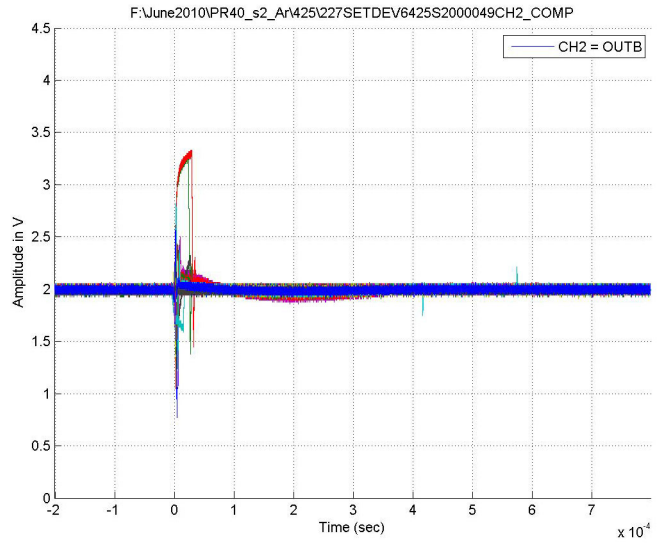

Figure 18. Typical Capture at $V_S = \pm 4.5V$, Channel B, LET = $17MeV \cdot cm^2/mg$, Run 425

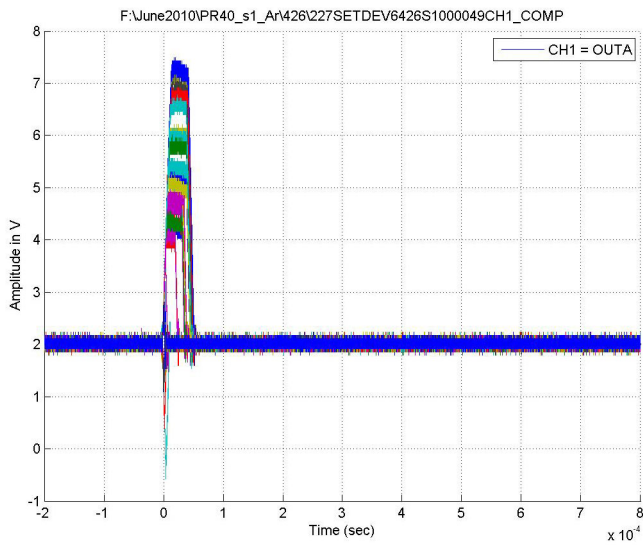

Figure 19. Typical Capture at $V_S = \pm 18V$, Channel A, LET = $17MeV \cdot cm^2/mg$, Run 426

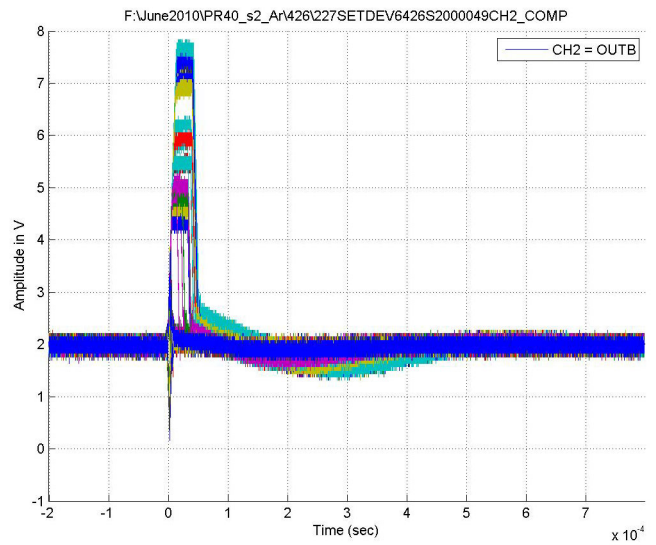

Figure 20. Typical Capture at $V_S = \pm 18V$, Channel B, LET = $17MeV \cdot cm^2/mg$, Run 404

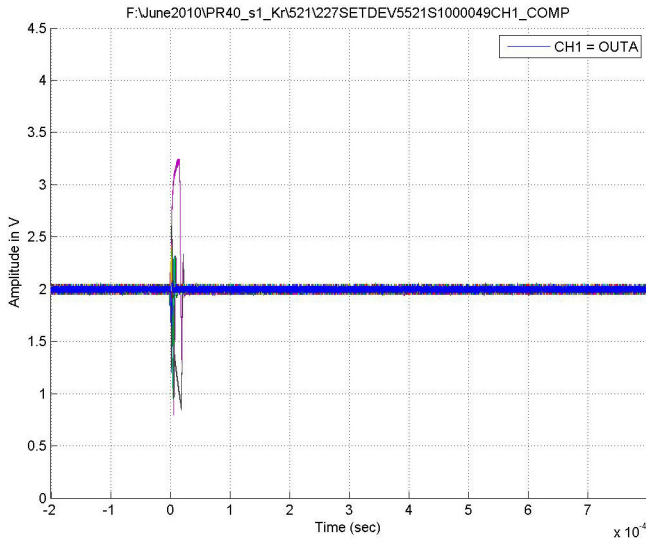

Figure 21. Typical Capture at $V_S = \pm 4.5V$, Channel A, LET = 28MeV·cm²/mg, Run 521

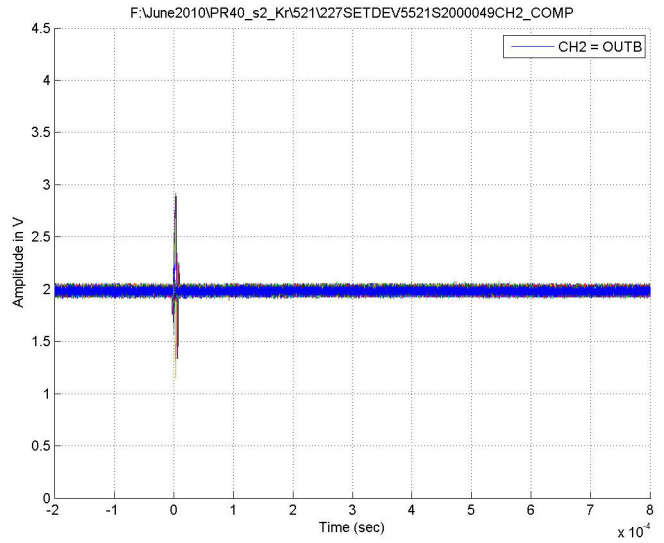

Figure 22. Typical Capture at $V_S = \pm 4.5V$, Channel B, LET = 28MeV·cm²/mg, Run 521

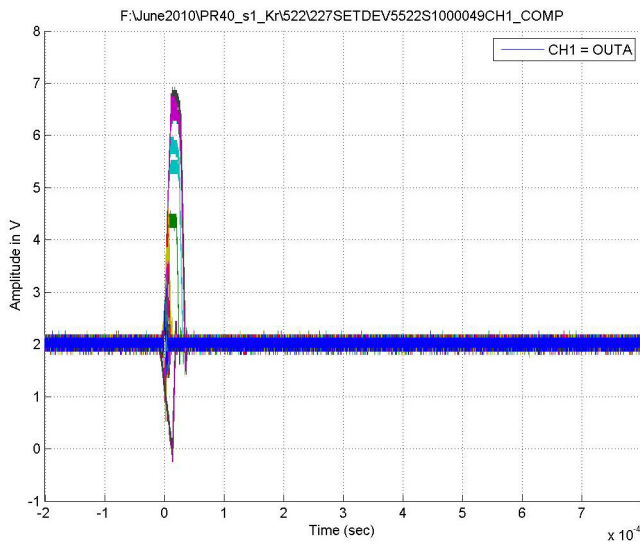

Figure 23. Typical Capture at $V_S = \pm 18V$, Channel A, LET = 28MeV·cm²/mg, Run 522

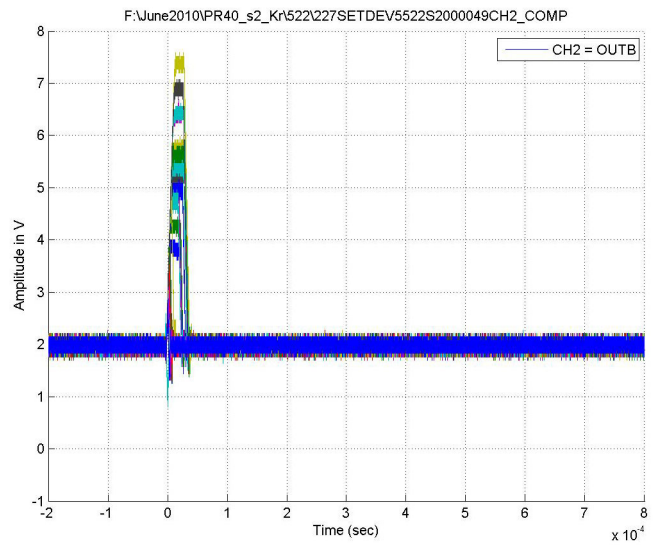

Figure 24. Typical Capture at $V_S = \pm 18V$, Channel B, LET = 28MeV·cm²/mg, Run 512

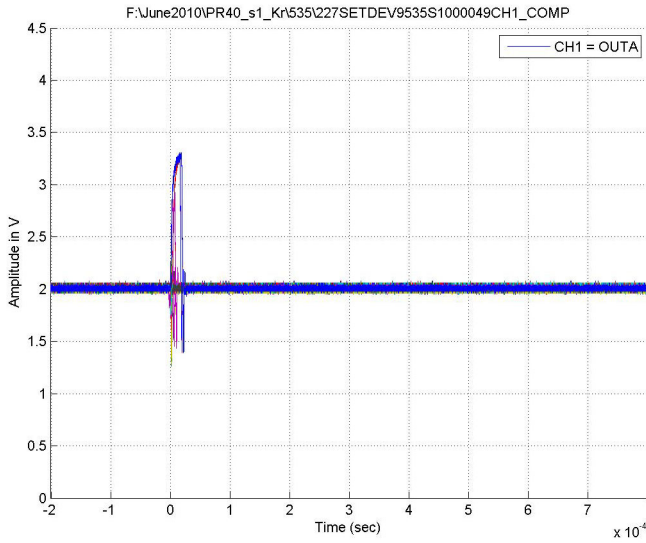

Figure 25. Typical Capture at $V_S = \pm 4.5V$, Channel A, $LET = 56MeV \cdot cm^2/mg$, Run 535

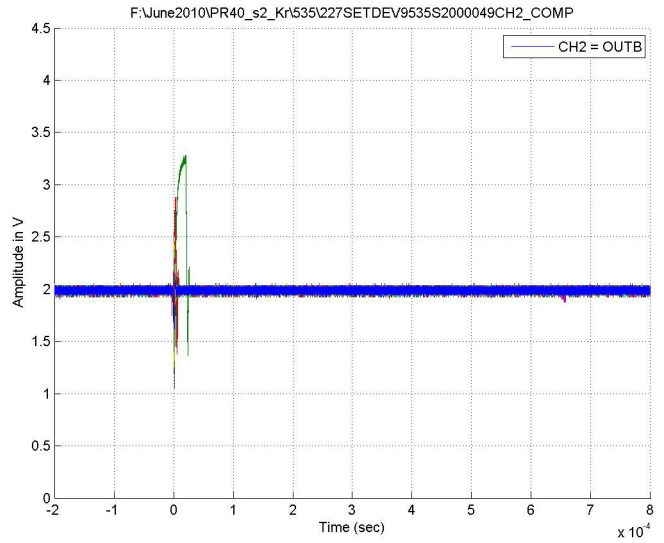

Figure 26. Typical Capture at $V_S = \pm 4.5V$, Channel B, $LET = 56MeV \cdot cm^2/mg$, Run 535

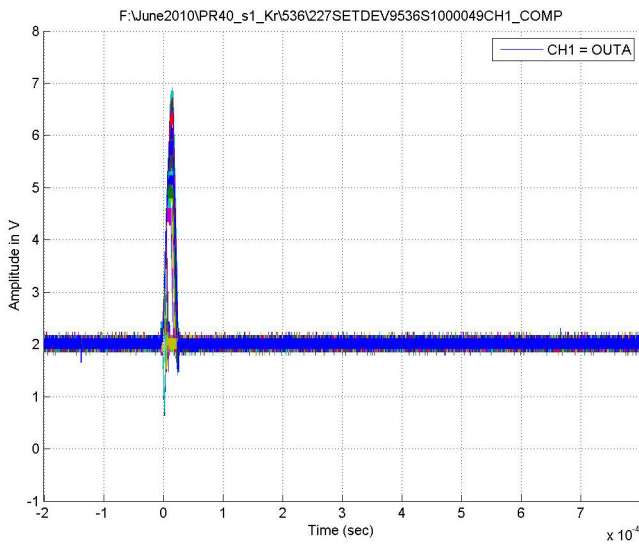

Figure 27. Typical Capture at $V_S = \pm 18V$, Channel A, $LET = 56MeV \cdot cm^2/mg$, Run 536

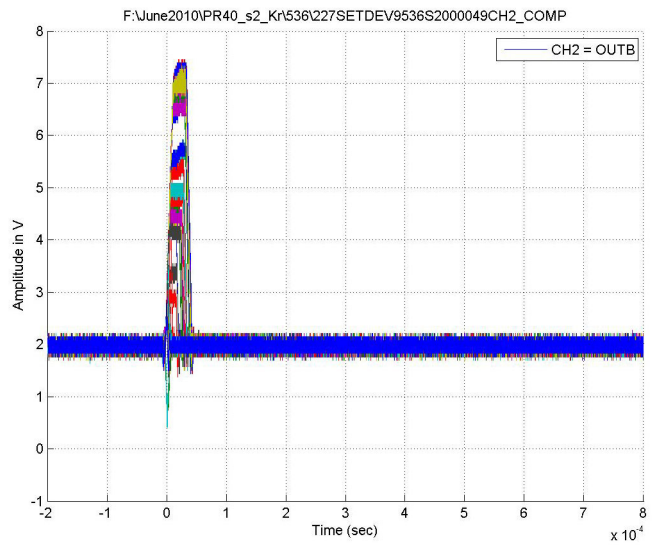

Figure 28. Typical Capture at $V_S = \pm 18V$, Channel B, $LET = 56MeV \cdot cm^2/mg$, Run 536

6. Summary

6.1 Single Event Burnout/Latch-up

No single event burnout (SEB) was observed for the device up to an LET of 86.4MeV•cm²/mg (+125°C) and voltage supply of $V_S = \pm 18.2V$. No single event latch-up (SEL) was observed for the device up to an LET of 86.4MeV•cm²/mg (+125°C) and voltage supply of $V_S = \pm 18.2V$. SEL and SEB were tested and passed at a supply voltage greater than that absolute maximum supply voltage of $\pm 18V$.

6.2 Single Event Transient

Based on the results presented, the ISL70227SxH op amp offers advantages over competitor's parts with respect to the duration of the SET output voltage excursion and a lower SET cross section at a gain of 10 [2][3]. For devices with $V_S = \pm 4.5V$ the worst case output voltage transient expected was 1V. This was not a surprise since the output voltage headroom is 1.5V maximum; with $V_S = \pm 4.5V$ the maximum output voltage expected is 3V. [Figure 14](#) shows the output driven to 3V and into saturation; the recovery time is less than 100 μ s. [Figure 13](#) shows the same phenomenon in a negative direction. For amplifiers supplied with a $V_S = \pm 18V$, the transient excursions were much larger, however they did not extend to the expected VOH or VOL levels of $\pm 16.5V$. All the transients observed were 6V deviations or less and recovery time of the transients were less than 100 μ s. Compared to the ISL70218SRH, this part does not experience the long recovery time during a single event transient. This may be explained by the higher drive capability of the ISL70227SxH and its ability to drive highly capacitive loads compared to the ISL70218SRH.

-
2. S. Larsson and S. Mattsson, [Heavy Ion Transients in Operational Amplifier of Type LM124, RH1014 and OP27](#)
 3. Ray Ladbury and Stephen Buchner, [SEE Testing of the RH1013 Dual Precision Operational Amplifier](#)

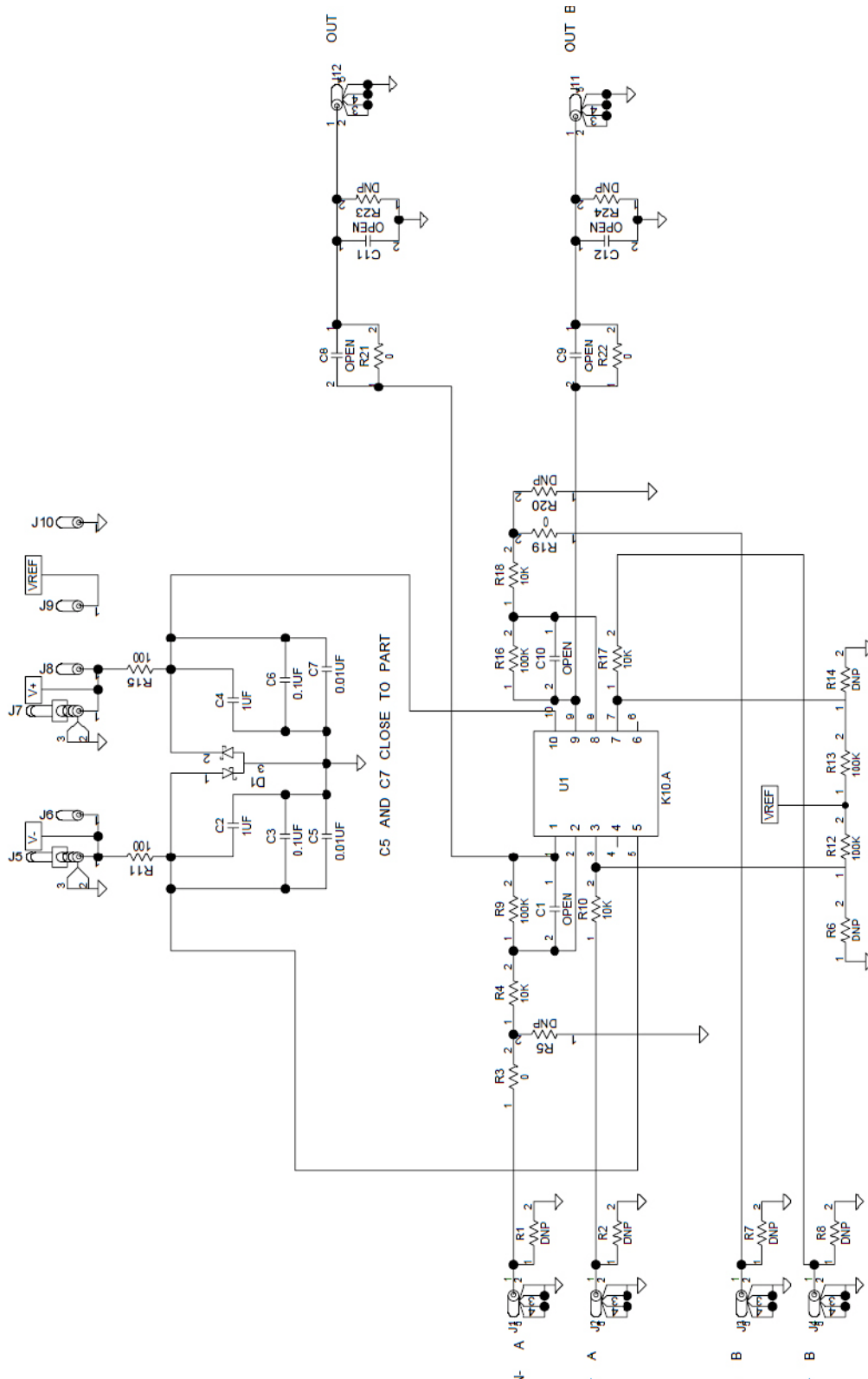

Figure 29. ISL70227SxH SEE Test Board Schematic

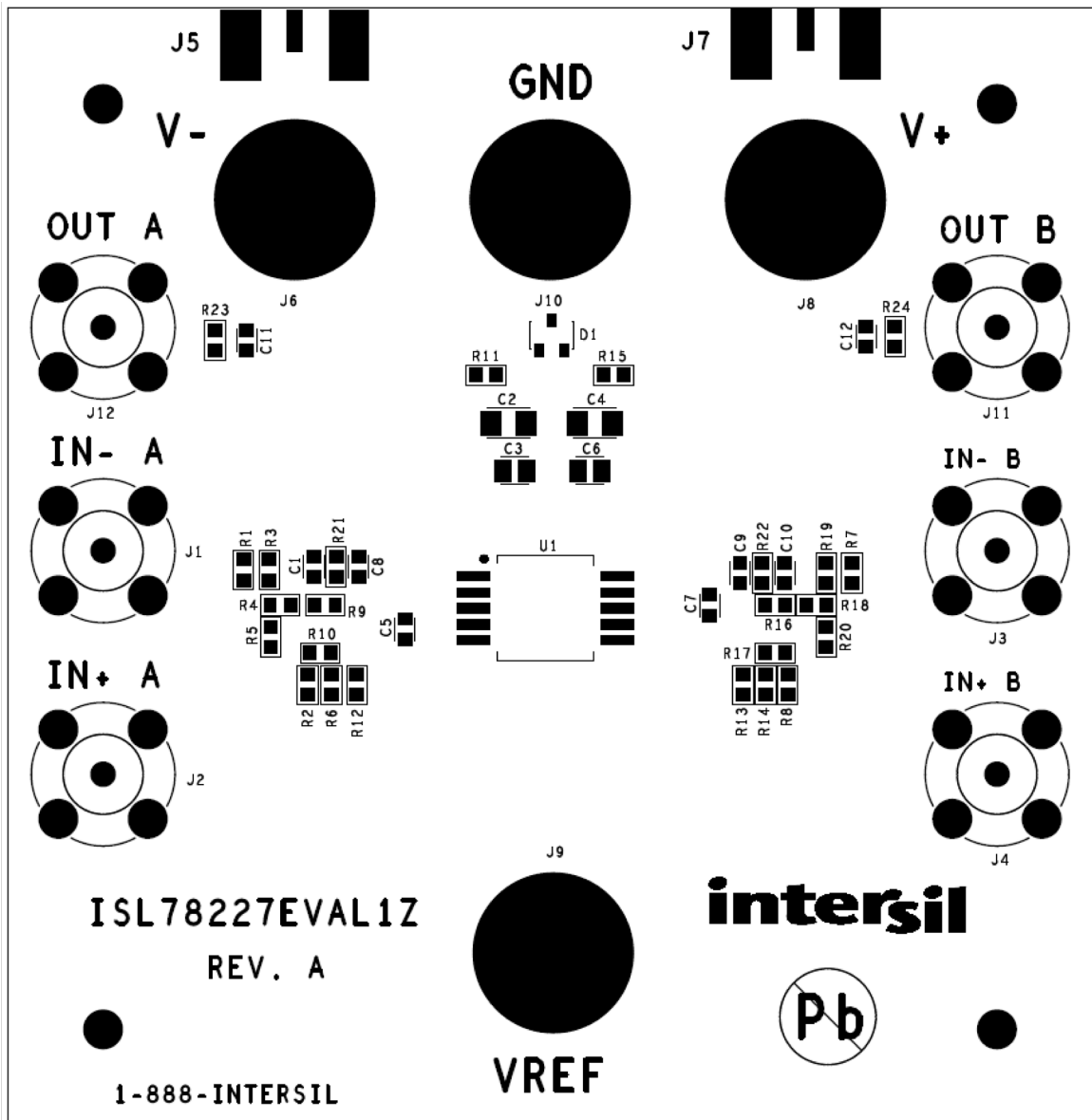

Figure 30. ISL70227SxH SEE Test Board Top View

7. Revision History

Revision	Date	Description
1.00	Jul 2, 2024	Applied latest template. Updated Table 2. Added ISL70227SEH reference.
0.00	May 21, 2012	Initial release.

IMPORTANT NOTICE AND DISCLAIMER

RENESAS ELECTRONICS CORPORATION AND ITS SUBSIDIARIES (“RENESAS”) PROVIDES TECHNICAL SPECIFICATIONS AND RELIABILITY DATA (INCLUDING DATASHEETS), DESIGN RESOURCES (INCLUDING REFERENCE DESIGNS), APPLICATION OR OTHER DESIGN ADVICE, WEB TOOLS, SAFETY INFORMATION, AND OTHER RESOURCES “AS IS” AND WITH ALL FAULTS, AND DISCLAIMS ALL WARRANTIES, EXPRESS OR IMPLIED, INCLUDING, WITHOUT LIMITATION, ANY IMPLIED WARRANTIES OF MERCHANTABILITY, FITNESS FOR A PARTICULAR PURPOSE, OR NON-INFRINGEMENT OF THIRD-PARTY INTELLECTUAL PROPERTY RIGHTS.

These resources are intended for developers who are designing with Renesas products. You are solely responsible for (1) selecting the appropriate products for your application, (2) designing, validating, and testing your application, and (3) ensuring your application meets applicable standards, and any other safety, security, or other requirements. These resources are subject to change without notice. Renesas grants you permission to use these resources only to develop an application that uses Renesas products. Other reproduction or use of these resources is strictly prohibited. No license is granted to any other Renesas intellectual property or to any third-party intellectual property. Renesas disclaims responsibility for, and you will fully indemnify Renesas and its representatives against, any claims, damages, costs, losses, or liabilities arising from your use of these resources. Renesas' products are provided only subject to Renesas' Terms and Conditions of Sale or other applicable terms agreed to in writing. No use of any Renesas resources expands or otherwise alters any applicable warranties or warranty disclaimers for these products.

(Disclaimer Rev.1.01 Jan 2024)

Corporate Headquarters

TOYOSU FORESIA, 3-2-24 Toyosu,
Koto-ku, Tokyo 135-0061, Japan
www.renesas.com

Trademarks

Renesas and the Renesas logo are trademarks of Renesas Electronics Corporation. All trademarks and registered trademarks are the property of their respective owners.

Contact Information

For further information on a product, technology, the most up-to-date version of a document, or your nearest sales office, please visit www.renesas.com/contact-us/.