

Introduction

This document reports the results of low and high dose rate total dose testing of the ISL70417SEH quad operational amplifier. The tests were conducted to provide an assessment of the total dose hardness of the part. Parts were irradiated under bias and with all pins grounded at low and high dose rate. The ISL70417SEH is acceptance tested on a wafer by wafer basis to 300krad(Si) at high dose rate (50 - 300rad(Si)/s) and to 50krad(Si) at low dose rate (0.01rad(Si)/s).

Reference Documents

- MIL-STD-883 test method 1019
- ISL70417SEH data sheet ([FN7962](#))

Part Description

The ISL70417SEH is a precision quad operational amplifier featuring low noise vs power consumption characteristics, low offset voltage, low input bias current and low temperature drift, making this device the ideal choice for hardened applications requiring high DC accuracy and moderate AC performance. The ISL70417SEH is offered in a 14 lead hermetic package. Constructed with Intersil's dielectrically isolated PR40 process, this device is immune to single event latchup. The ISL70417SEH offers guaranteed performance over the full -55°C to +125°C military temperature range. Key pre- and post-radiation specifications follow.

Key Specifications

- Input offset voltage ±75µV pre, ±110µV post
- Input offset voltage TC 1.0µV/°C post maximum
- Input bias current ±1.0nA pre, ±5.0nA post
- Input bias current TC ±5pA/°C post, maximum
- Supply current, each amplifier 530µA pre, 680µA post, maximum
- Voltage noise 8nV/√Hz post, maximum
- Supply voltage range 4.5V-40V in beam (LET = 73MeV.cm²/mg)
- Operating temperature range -55°C to +125°C

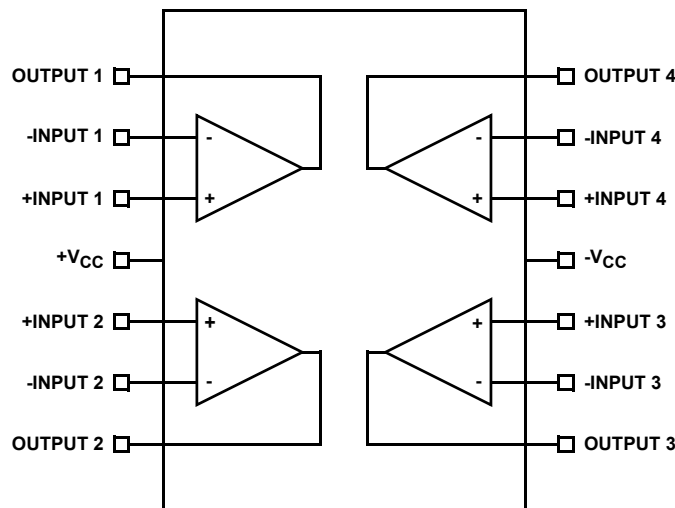

FIGURE 1. ISL70417SEH BLOCK DIAGRAM

Test Description

Irradiation Facilities

High dose rate testing was performed at 50rad(Si)/s using a Gammacell 220 ⁶⁰Co irradiator located in the Palm Bay, Florida Intersil facility. Low dose rate testing was performed at 0.01rad(Si)/s using the Intersil Palm Bay panoramic ⁶⁰Co irradiator.

Test Fixturing

Figure 2 shows the configuration used for biased irradiation.

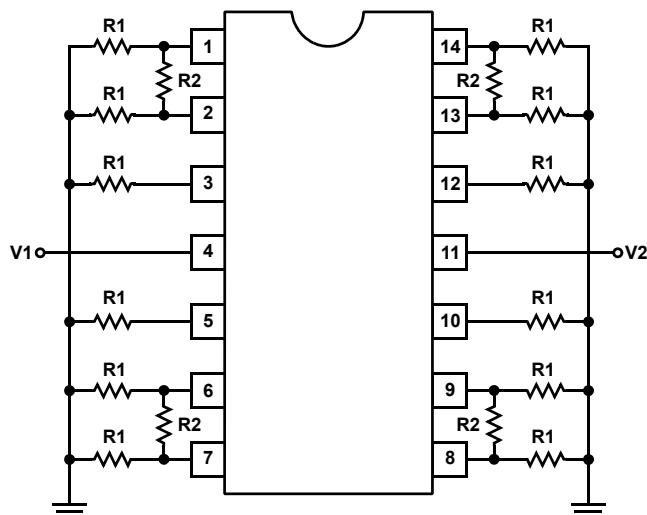

FIGURE 2. IRRADIATION BIAS CONFIGURATION FOR THE ISL70417SEH

Characterization Equipment and Procedures

All electrical testing was performed outside the irradiator using the production automated test equipment (ATE) with datalogging at each downpoint. Downpoint electrical testing was performed at room temperature.

Experimental Matrix

Total dose irradiation proceeded in accordance with the guidelines of MIL-STD-883 Test Method 1019.7. The experimental matrix consisted of six samples irradiated at low dose rate under bias, six samples irradiated at low dose rate with all pins grounded, five samples irradiated at high dose rate under bias and five samples irradiated at high dose rate with all pins grounded.

Samples of the ISL70417SEH were drawn from preproduction inventory and were packaged in the hermetic 14 Ld solder-sealed flatpack (CDFP4-F14) package. Samples were processed through the standard burnin cycle before irradiation, as required by MIL-STD-883, and were screened to the ATE limits at room temperature prior to the test.

Downpoints

Downpoints for the low dose rate tests were zero, 50 and 100krad(Si). Downpoints for the high dose rate tests were 0, 50, 100, 150, 200 and 300krad(Si).

Results

Test Results

Testing at low and high dose rate of the ISL70417SEH is complete.

The input offset voltage was extremely stable over both tests. The positive and negative input bias currents were stable over high dose rate irradiation, but showed an increase over low dose rate. The parameters remained within the post-irradiation specification limits but the part is considered low dose rate sensitive based on the 'delta parameter' diagnostic algorithm outlined in MIL-STD-888 test method 1019. The input offset current showed some variation at low dose rate but remained well within the Group A limits. The positive and negative open-loop gain remained stable but showed considerable variation, which is considered indicative of testing issues for this parameter and not of any effects of ⁶⁰Co irradiation. The positive and negative power supply rejection ratio and common mode rejection ratio were stable over both tests, as were the positive and negative supply currents. The positive and negative slew rates were stable.

No differences in total dose response were noted between biased and grounded irradiation for any parameters. Additionally, no channel to channel differences were noted, either in the pre-irradiation data or in the total dose response of the parts.

Variables Data

The plots in Figures 3 through 16 show data at all downpoints. The plots show the median of key parameters as a function of low and high dose rate total dose for each of the two irradiation conditions. We chose to plot the median for these parameters due to the relatively small sample size of five or six per experimental cell.

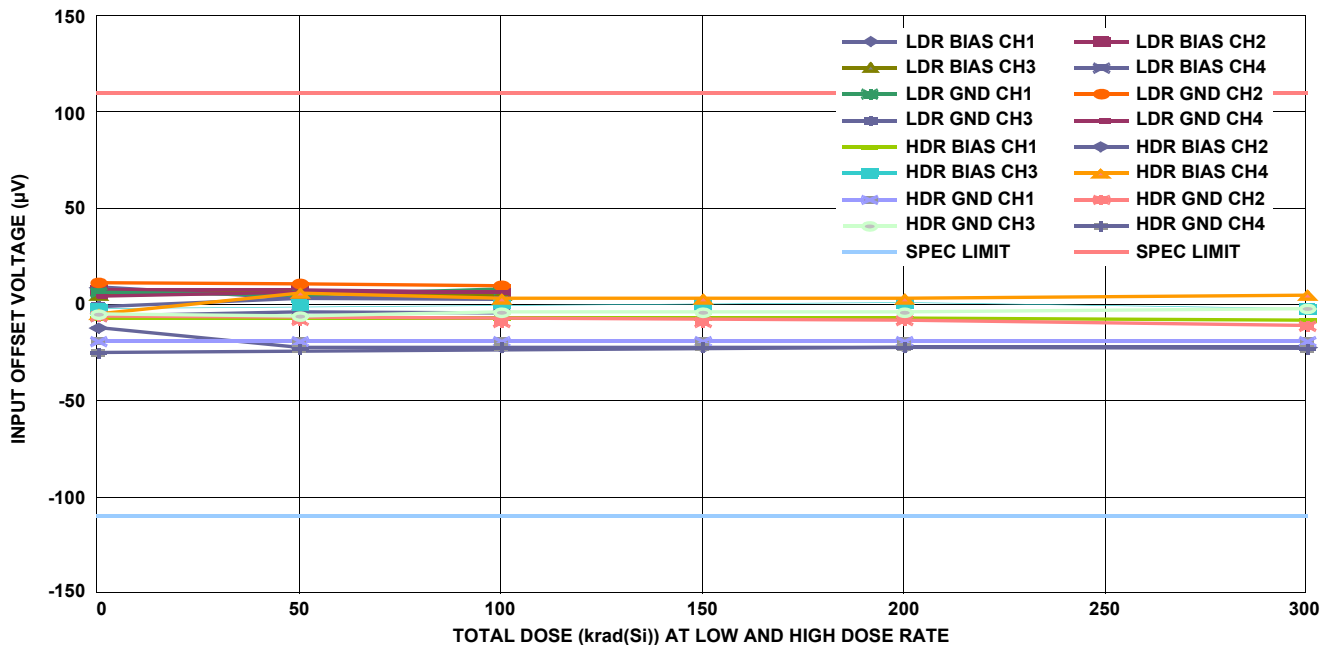

FIGURE 3. ISL70417SEH input offset voltage, channels 1 through 4, as a function of total dose irradiation at low and high dose rate for the biased (per Figure 2) and unbiased (all pins grounded) cases. The dose rate was 0.01rad(Si)/s for low dose rate irradiation and 50rad(Si)/s for high dose rate irradiation. Sample size for the low dose rate cells was 6, while the sample size for the high dose rate cells was 5. The pre-irradiation limits are -75µV to +75µV, while the post-irradiation limits are -110µV to +110µV.

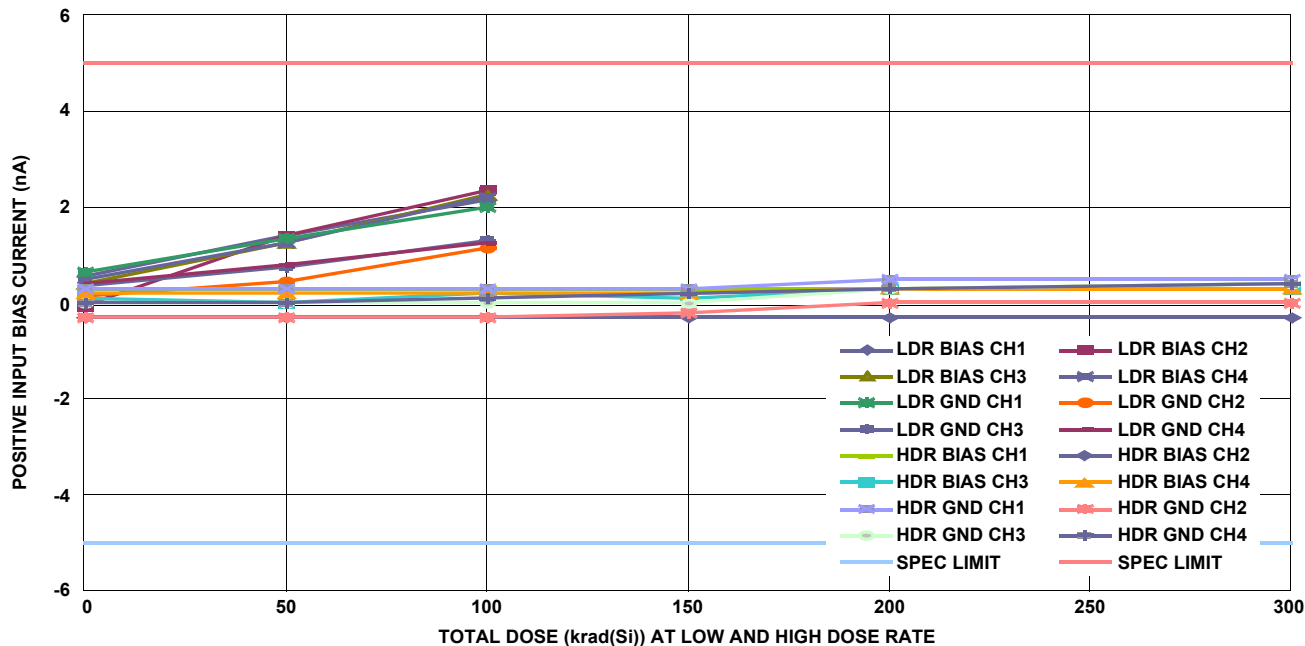

FIGURE 4. ISL70417SEH positive input bias current, channels 1 through 4, as a function of total dose irradiation at low and high dose rate for the biased (per Figure 2) and unbiased (all pins grounded) cases. The dose rate was 0.01rad(Si)/s for low dose rate irradiation and 50rad(Si)/s for high dose rate irradiation. Sample size for the low dose rate cells was 6, while the sample size for the high dose rate cells was 5. The pre-irradiation limits are -1.0nA to +1.0nA, while the post-irradiation limits are -5.0nA to +5.0nA.

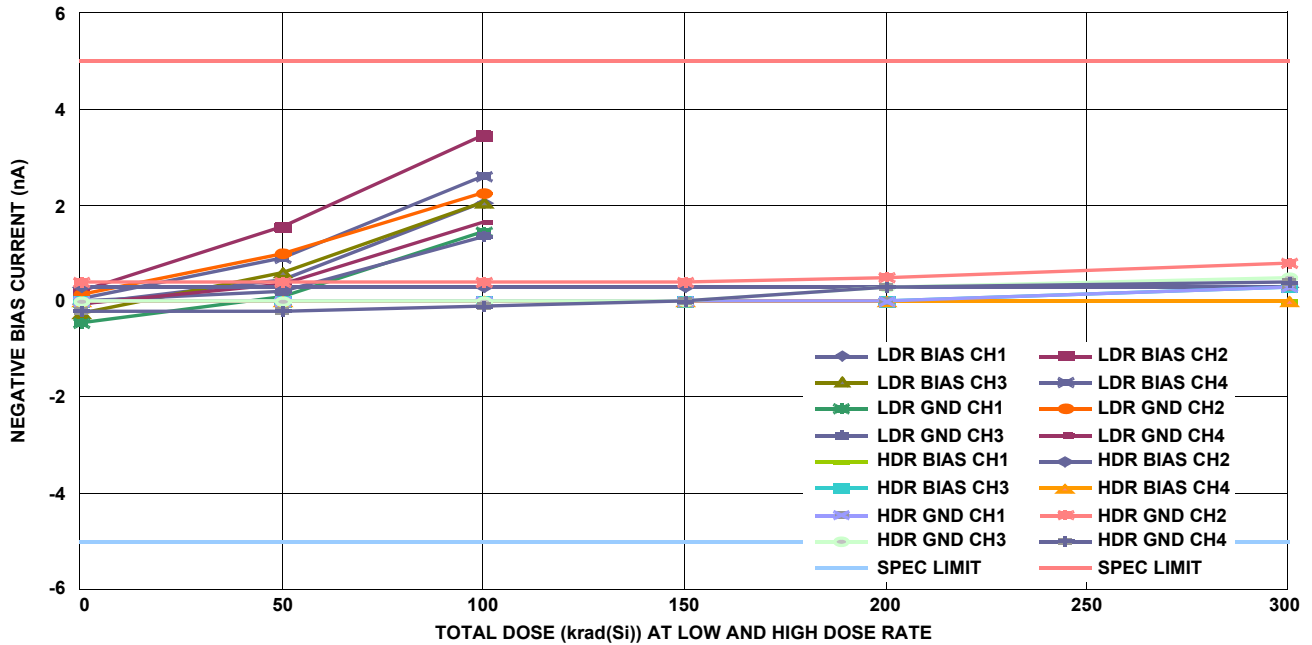

FIGURE 5. ISL70417SEH negative input bias current, channels 1 through 4, as a function of total dose irradiation at low and high dose rate for the biased (per Figure 2) and unbiased (all pins grounded) cases. The dose rate was 0.01rad(Si)/s for low dose rate irradiation and 50rad(Si)/s for high dose rate irradiation. Sample size for the low dose rate cells was 6, while the sample size for the high dose rate cells was 5. The pre-irradiation limits are -1.0nA to +1.0nA, while the post-irradiation limits are -5.0nA to +5.0nA.

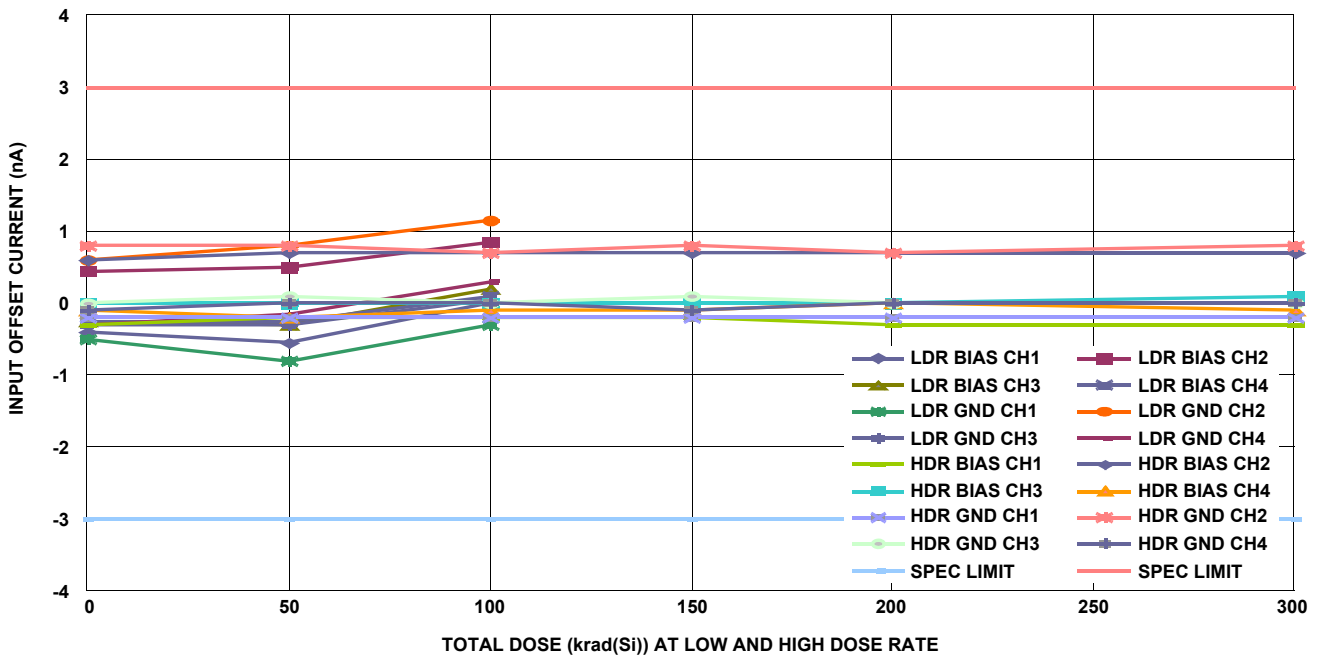

FIGURE 6. ISL70417SEH input offset current, channels 1 through 4, as a function of total dose irradiation at low and high dose rate for the biased (per Figure 2) and unbiased (all pins grounded) cases. The dose rate was 0.01rad(Si)/s for low dose rate irradiation and 50rad(Si)/s for high dose rate irradiation. Sample size for the low dose rate cells was 6, while the sample size for the high dose rate cells was 5. The pre-irradiation limits are -1.5nA to +1.5nA, while the post-irradiation limits are -3.0nA to +3.0nA.

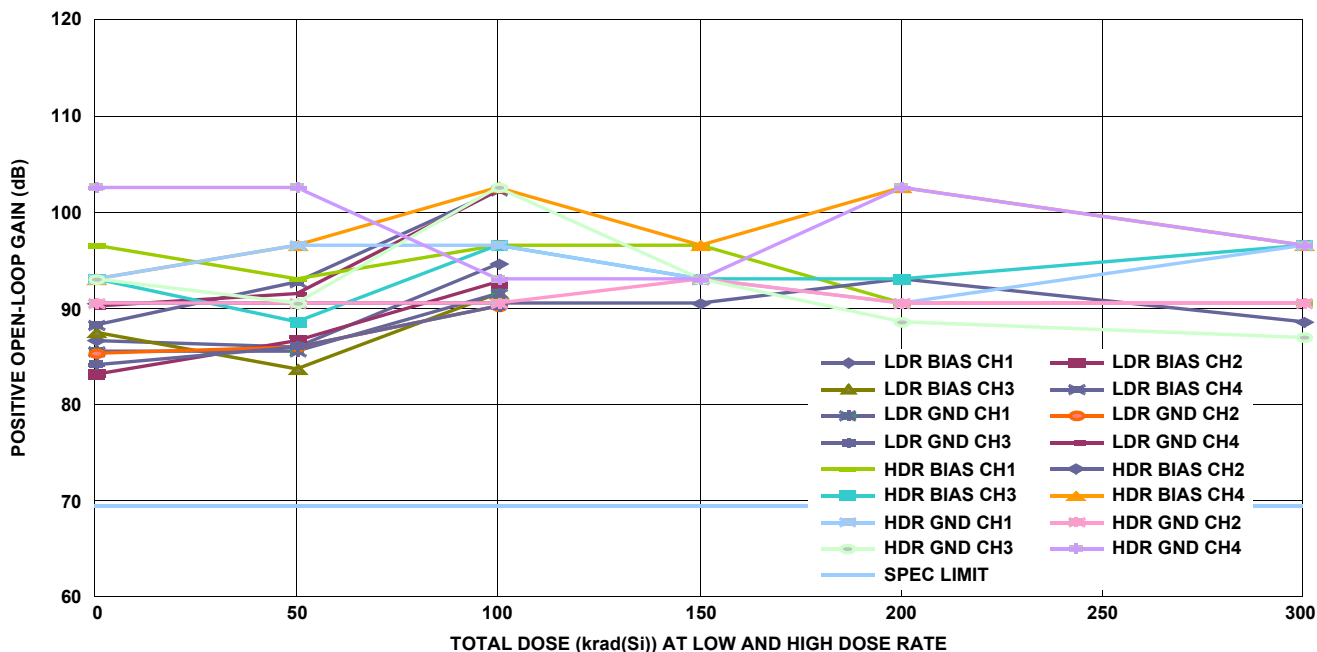

FIGURE 7. ISL70417SEH positive open-loop voltage gain, channels 1 through 4, as a function of total dose irradiation at low and high dose rate for the biased (per Figure 2) and unbiased (all pins grounded) cases. The dose rate was 0.01rad(Si)/s for low dose rate irradiation and 50rad(Si)/s for high dose rate irradiation. Sample size for the low dose rate cells was 6, while the sample size for the high dose rate cells was 5. The pre- and post-irradiation limits are 69.5dB minimum.

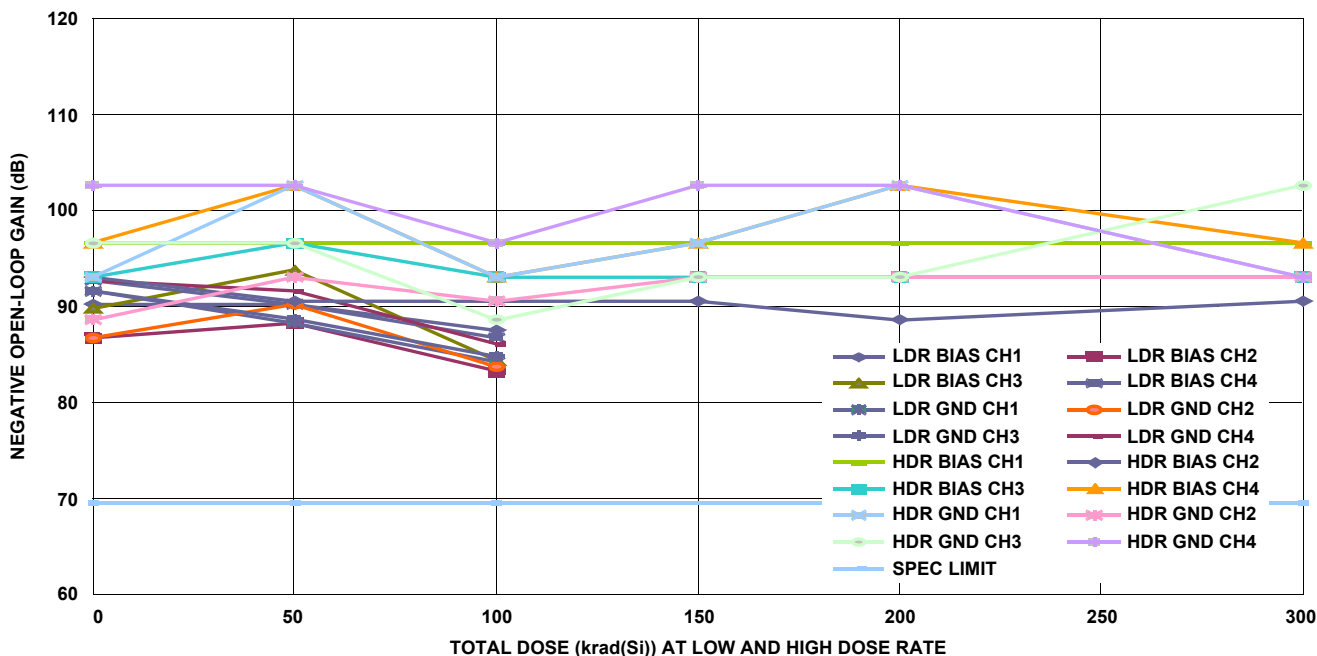

FIGURE 8. ISL70417SEH negative open-loop voltage gain, channels 1 through 4, as a function of total dose irradiation at low and high dose rate for the biased (per Figure 2) and unbiased (all pins grounded) cases. The dose rate was 0.01rad(Si)/s for low dose rate irradiation and 50rad(Si)/s for high dose rate irradiation. Sample size for the low dose rate cells was 6, while the sample size for the high dose rate cells was 5. The pre- and post-irradiation limits are 69.5dB minimum.

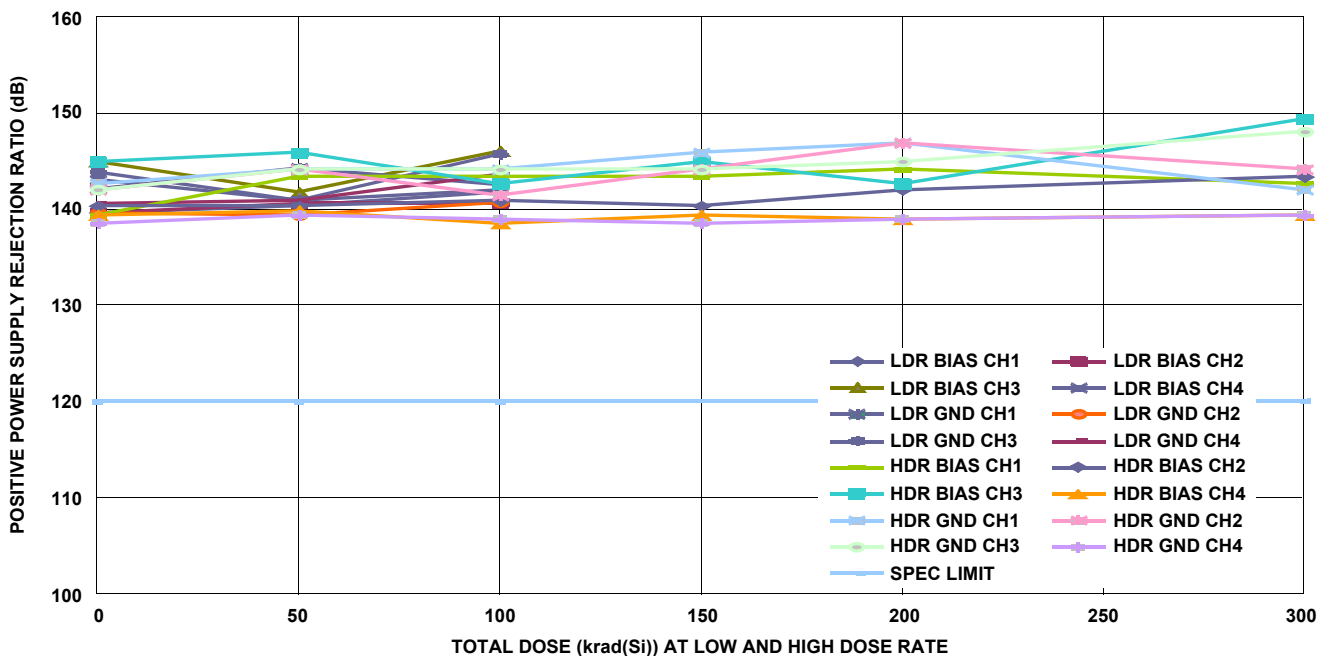

FIGURE 9. ISL70417SEH positive power supply rejection ratio, channels 1 through 4, as a function of total dose irradiation at low and high dose rate for the biased (per Figure 2) and unbiased (all pins grounded) cases. The dose rate was 0.01rad(Si)/s for low dose rate irradiation and 50rad(Si)/s for high dose rate irradiation. Sample size for the low dose rate cells was 6, while the sample size for the high dose rate cells was 5. The pre- and post-irradiation limits are 120.0dB minimum.

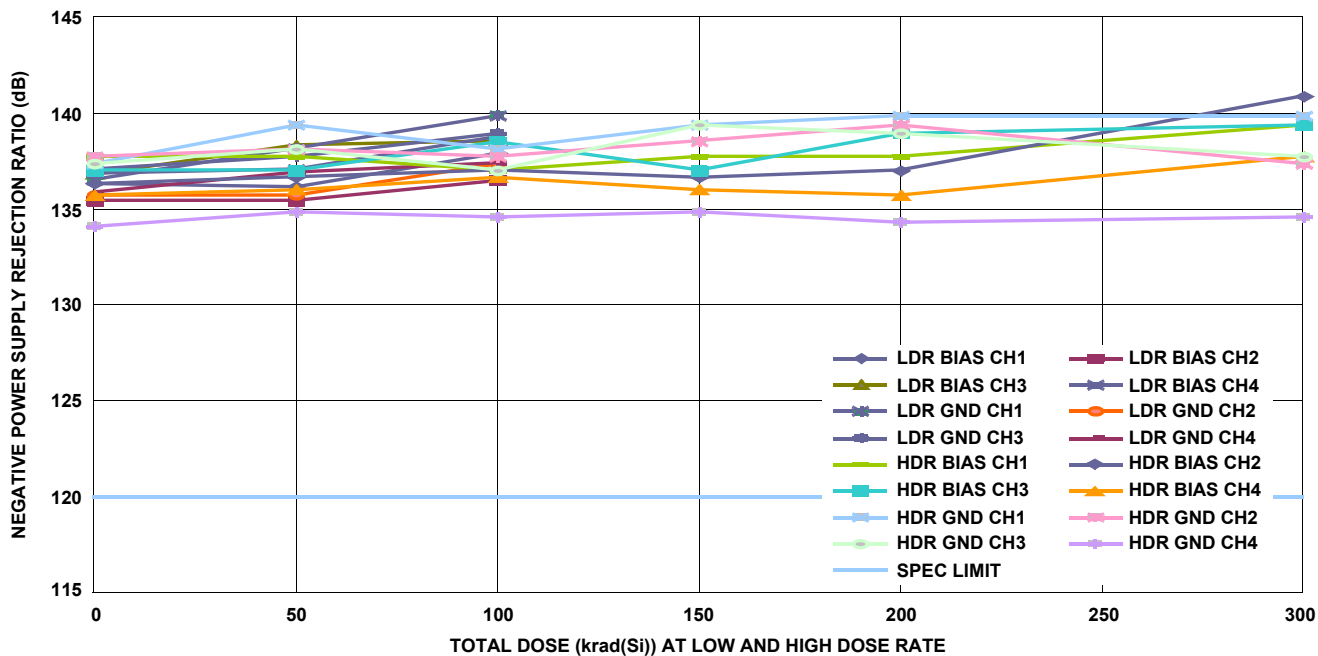

FIGURE 10. ISL70417SEH negative power supply rejection ratio, channels 1 through 4, as a function of total dose irradiation at low and high dose rate for the biased (per Figure 2) and unbiased (all pins grounded) cases. The dose rate was 0.01rad(Si)/s for low dose rate irradiation and 50rad(Si)/s for high dose rate irradiation. Sample size for the low dose rate cells was 6, while the sample size for the high dose rate cells was 5. The pre- and post-irradiation limits are 120.0dB minimum.

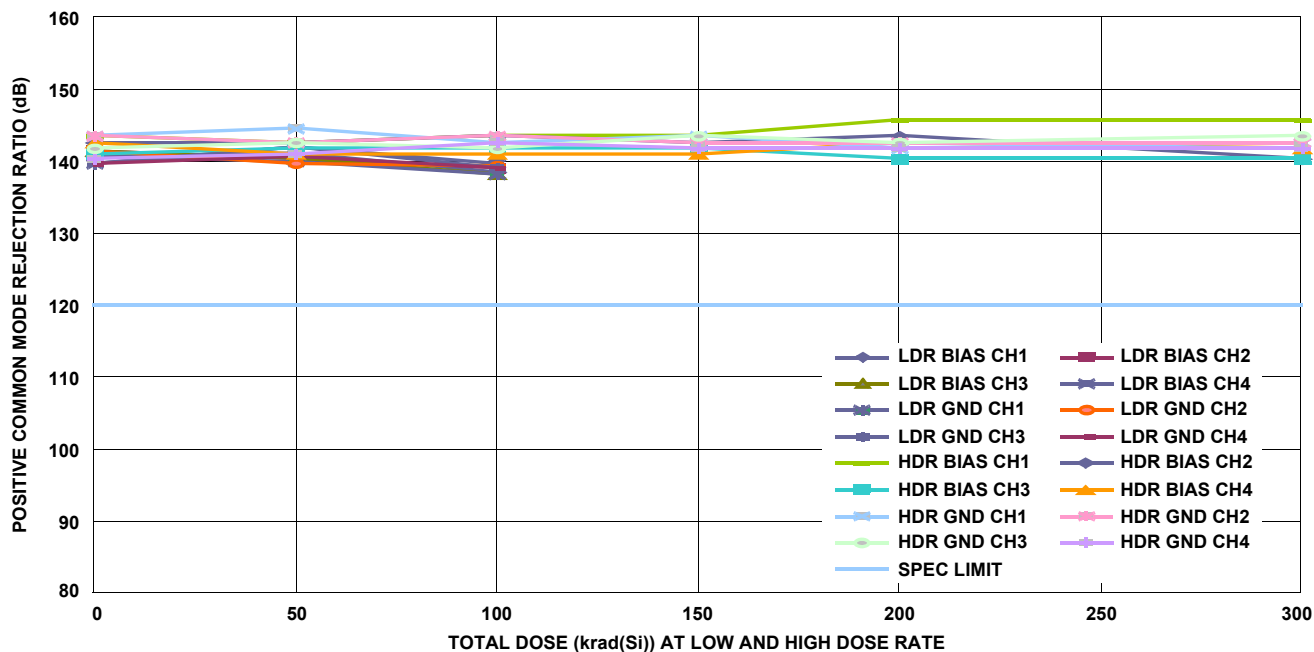

FIGURE 11. ISL70417SEH positive common mode rejection ratio, channels 1 through 4, as a function of total dose irradiation at low and high dose rate for the biased (per Figure 2) and unbiased (all pins grounded) cases. The dose rate was 0.01rad(Si)/s for low dose rate irradiation and 50rad(Si)/s for high dose rate irradiation. Sample size for the low dose rate cells was 6, while the sample size for the high dose rate cells was 5. The pre- and post-irradiation limits are 120.0dB minimum.

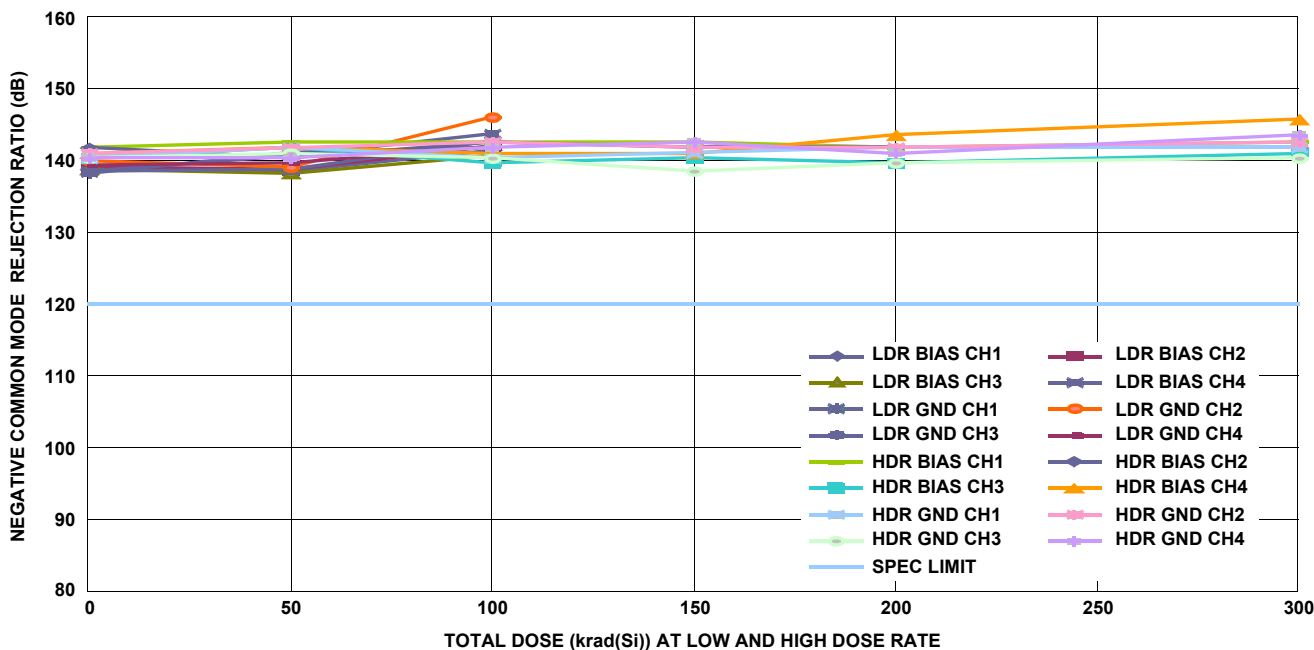

FIGURE 12. ISL70417SEH negative common mode rejection ratio, channels 1 through 4, as a function of total dose irradiation at low and high dose rate for the biased (per Figure 2) and unbiased (all pins grounded) cases. The dose rate was 0.01rad(Si)/s for low dose rate irradiation and 50rad(Si)/s for high dose rate irradiation. Sample size for the low dose rate cells was 6, while the sample size for the high dose rate cells was 5. The pre- and post-irradiation limits are 120.0dB minimum.

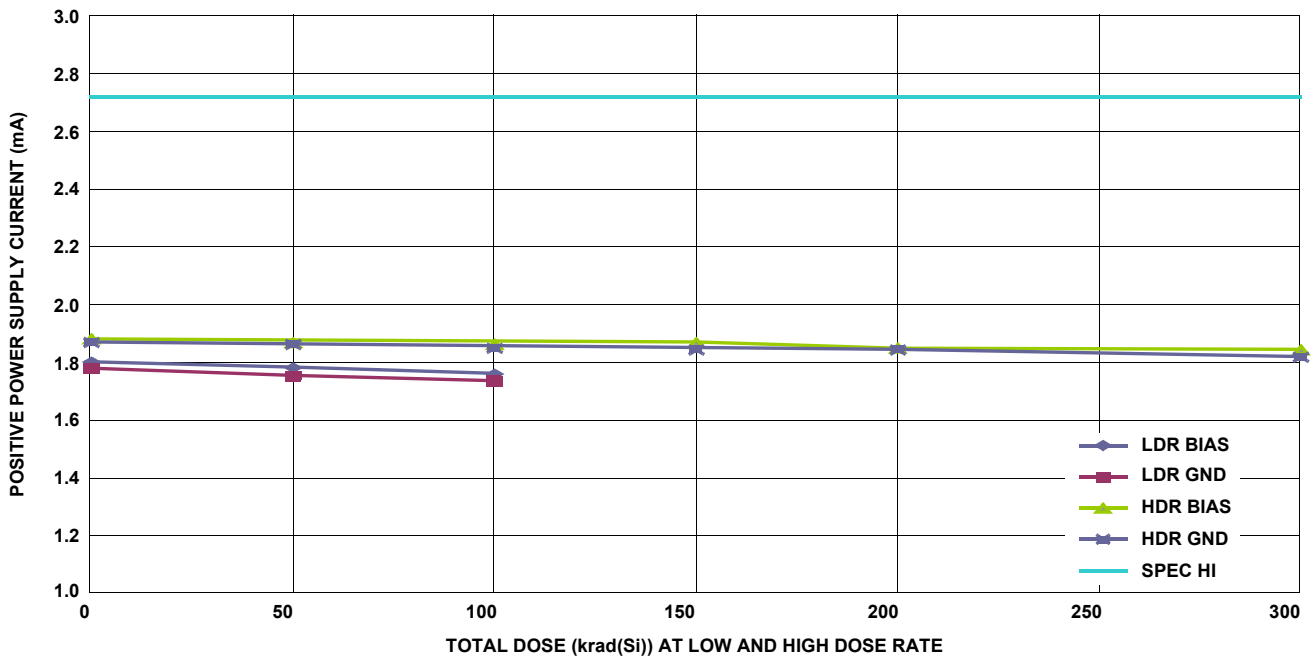

FIGURE 13. ISL70417SEH positive power supply current, sum of all four channels (1 through 4), as a function of total dose irradiation at low and high dose rate for the biased (per Figure 2) and unbiased (all pins grounded) cases. The dose rate was 0.01rad(Si)/s for low dose rate irradiation and 50rad(Si)/s for high dose rate irradiation. Sample size for the low dose rate cells was 6, while the sample size for the high dose rate cells was 5. The pre-irradiation limit is -2.12mA maximum and the post-irradiation limit is -2.72mA maximum.

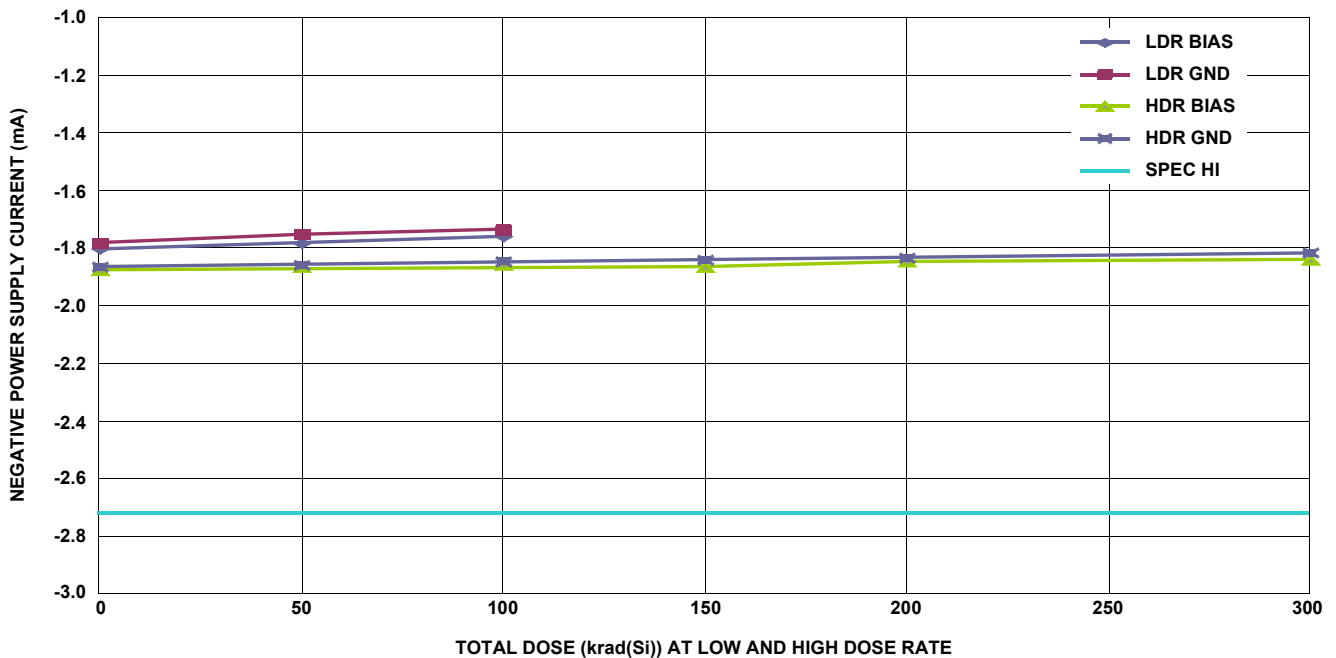

FIGURE 14. ISL70417SEH negative power supply current, sum of all four channels (1 through 4), as a function of total dose irradiation at low and high dose rate for the biased (per Figure 2) and unbiased (all pins grounded) cases. The dose rate was 0.01rad(Si)/s for low dose rate irradiation and 50rad(Si)/s for high dose rate irradiation. Sample size for the low dose rate cells was 6, while the sample size for the high dose rate cells was 5. The pre-irradiation limit is -2.12mA maximum and the post-irradiation limit is -2.72mA maximum.

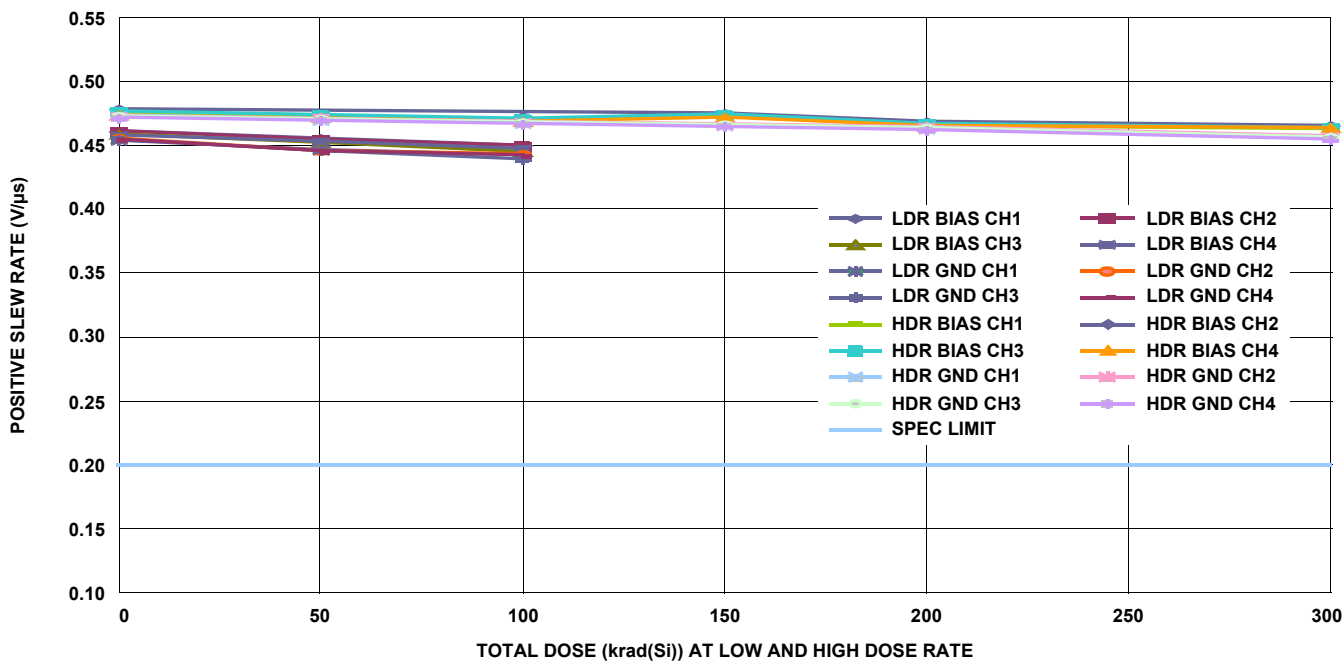

FIGURE 15. ISL70417SEH positive slew rate, channels 1 through 4, as a function of total dose irradiation at low and high dose rate for the biased (per Figure 2) and unbiased (all pins grounded) cases. The dose rate was 0.01rad(Si)/s for low dose rate irradiation and 50rad(Si)/s for high dose rate irradiation. Sample size for the low dose rate cells was 6, while the sample size for the high dose rate cells was 5. The pre-irradiation limit is 0.30V/μs minimum and the post-irradiation limit is 0.20V/μs minimum.

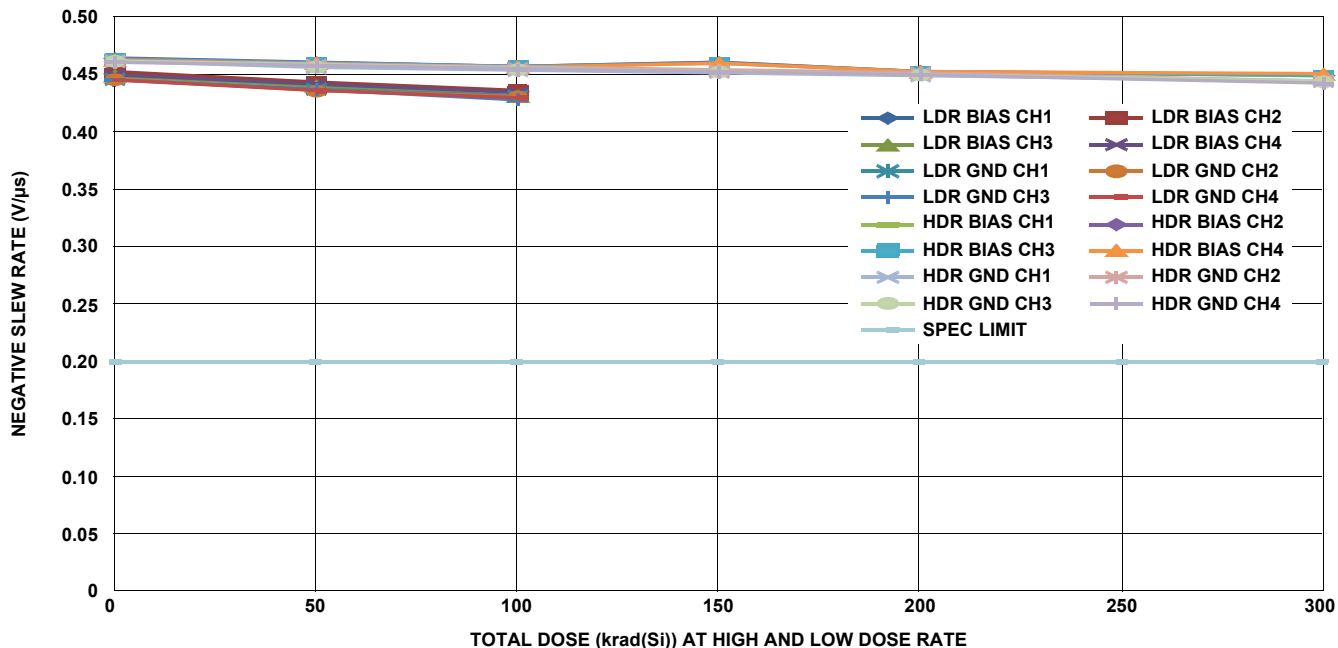

FIGURE 16. ISL70417SEH negative slew rate, channels 1 through 4, as a function of total dose irradiation at low and high dose rate for the biased (per Figure 2) and unbiased (all pins grounded) cases. The dose rate was 0.01rad(Si)/s for low dose rate irradiation and 50rad(Si)/s for high dose rate irradiation. Sample size for the low dose rate cells was 6, while the sample size for the high dose rate cells was 5. The pre-irradiation limit is 0.30V/μs minimum and the post-irradiation limit is 0.20V/μs minimum.

Conclusion

This document reports results of low and high dose rate testing of the ISL70417SEH quad operational amplifier. Parts were tested at low and high dose rate under biased and unbiased conditions per MIL-STD-883 Test Method 1019.7, at 0.01rad(Si)/s and 50rad(Si)/s respectively. The low dose rate test was run to 150krad(Si) and the high dose rate was run to 300krad(Si). All parameters remained within the post-irradiation limits to the maximum total dose for each test.

The positive and negative input bias currents were stable over high dose rate irradiation but showed an increase over low dose

rate. The parameter remained within the post-irradiation specification limits, but the part must be considered low dose rate sensitive based on the 'delta parameter' diagnostic algorithm outlined in MIL-STD-888 test method 1019. The part is acceptance tested on a wafer by wafer basis to 300krad(Si) at high dose rate (50 – 300rad(Si)/s) and to 50krad(Si) at low dose rate (0.01rad(Si)/s), insuring hardness to the specified level for both dose rates. No significant differences in total dose response were noted between biased and grounded irradiation for any parameters. Additionally, no channel to channel differences were noted, either in the pre-irradiation data or in the total dose response of the parts.

Appendices

Reported parameters and their post-irradiation limits.

TABLE 1. REPORTED PARAMETERS

FIGURE	PARAMETER	LIMIT, LOW	LIMIT, HIGH	UNITS	NOTES
3	Input offset voltage	-110	+110	μV	Channels 1 through 4
4	Positive input bias current	-5.0	+5.0	nA	Channels 1 through 4
5	Negative input bias current	-5.0	+5.0	nA	Channels 1 through 4
6	Input offset current	-3.0	+3.0	nA	Channels 1 through 4
7	Positive open loop gain, biased	69.5		dB	Channels 1 through 4
8	Negative open loop gain, biased	69.5		dB	Channels 1 through 4
9	Positive power supply rejection ratio	120		dB	Channels 1 through 4
10	Negative power supply rejection ratio	120		dB	Channels 1 through 4
11	Positive common mode rejection ratio	120		dB	Channels 1 through 4
12	Positive common mode rejection ratio	120		dB	Channels 1 through 4
13	Positive supply current		2.72	mA	Sum of all 4 channels
14	Negative supply current		2.72	mA	Sum of all 4 channels
15	Positive slew rate	0.2		V/μs	Channels 1 through 4
16	Negative slew rate	0.2		V/μs	Channels 1 through 4

Revision History

The revision history provided is for informational purposes only and is believed to be accurate, but not warranted. Please go to web to make sure you have the latest revision.

DATE	REVISION	CHANGE
January 14, 2013	AN1792.0	Initial Release.

Notice

1. Descriptions of circuits, software and other related information in this document are provided only to illustrate the operation of semiconductor products and application examples. You are fully responsible for the incorporation or any other use of the circuits, software, and information in the design of your product or system. Renesas Electronics disclaims any and all liability for any losses and damages incurred by you or third parties arising from the use of these circuits, software, or information.
2. Renesas Electronics hereby expressly disclaims any warranties against and liability for infringement or any other claims involving patents, copyrights, or other intellectual property rights of third parties, by or arising from the use of Renesas Electronics products or technical information described in this document, including but not limited to, the product data, drawings, charts, programs, algorithms, and application examples.
3. No license, express, implied or otherwise, is granted hereby under any patents, copyrights or other intellectual property rights of Renesas Electronics or others.
4. You shall not alter, modify, copy, or reverse engineer any Renesas Electronics product, whether in whole or in part. Renesas Electronics disclaims any and all liability for any losses or damages incurred by you or third parties arising from such alteration, modification, copying or reverse engineering.
5. Renesas Electronics products are classified according to the following two quality grades: "Standard" and "High Quality". The intended applications for each Renesas Electronics product depends on the product's quality grade, as indicated below.
"Standard": Computers; office equipment; communications equipment; test and measurement equipment; audio and visual equipment; home electronic appliances; machine tools; personal electronic equipment; industrial robots; etc.
"High Quality": Transportation equipment (automobiles, trains, ships, etc.); traffic control (traffic lights); large-scale communication equipment; key financial terminal systems; safety control equipment; etc.
Unless expressly designated as a high reliability product or a product for harsh environments in a Renesas Electronics data sheet or other Renesas Electronics document, Renesas Electronics products are not intended or authorized for use in products or systems that may pose a direct threat to human life or bodily injury (artificial life support devices or systems; surgical implantations; etc.), or may cause serious property damage (space system; undersea repeaters; nuclear power control systems; aircraft control systems; key plant systems; military equipment; etc.). Renesas Electronics disclaims any and all liability for any damages or losses incurred by you or any third parties arising from the use of any Renesas Electronics product that is inconsistent with any Renesas Electronics data sheet, user's manual or other Renesas Electronics document.
6. When using Renesas Electronics products, refer to the latest product information (data sheets, user's manuals, application notes, "General Notes for Handling and Using Semiconductor Devices" in the reliability handbook, etc.), and ensure that usage conditions are within the ranges specified by Renesas Electronics with respect to maximum ratings, operating power supply voltage range, heat dissipation characteristics, installation, etc. Renesas Electronics disclaims any and all liability for any malfunctions, failure or accident arising out of the use of Renesas Electronics products outside of such specified ranges.
7. Although Renesas Electronics endeavors to improve the quality and reliability of Renesas Electronics products, semiconductor products have specific characteristics, such as the occurrence of failure at a certain rate and malfunctions under certain use conditions. Unless designated as a high reliability product or a product for harsh environments in a Renesas Electronics data sheet or other Renesas Electronics document, Renesas Electronics products are not subject to radiation resistance design. You are responsible for implementing safety measures to guard against the possibility of bodily injury, injury or damage caused by fire, and/or danger to the public in the event of a failure or malfunction of Renesas Electronics products, such as safety design for hardware and software, including but not limited to redundancy, fire control and malfunction prevention, appropriate treatment for aging degradation or any other appropriate measures. Because the evaluation of microcomputer software alone is very difficult and impractical, you are responsible for evaluating the safety of the final products or systems manufactured by you.
8. Please contact a Renesas Electronics sales office for details as to environmental matters such as the environmental compatibility of each Renesas Electronics product. You are responsible for carefully and sufficiently investigating applicable laws and regulations that regulate the inclusion or use of controlled substances, including without limitation, the EU RoHS Directive, and using Renesas Electronics products in compliance with all these applicable laws and regulations. Renesas Electronics disclaims any and all liability for damages or losses occurring as a result of your noncompliance with applicable laws and regulations.
9. Renesas Electronics products and technologies shall not be used for or incorporated into any products or systems whose manufacture, use, or sale is prohibited under any applicable domestic or foreign laws or regulations. You shall comply with any applicable export control laws and regulations promulgated and administered by the governments of any countries asserting jurisdiction over the parties or transactions.
10. It is the responsibility of the buyer or distributor of Renesas Electronics products, or any other party who distributes, disposes of, or otherwise sells or transfers the product to a third party, to notify such third party in advance of the contents and conditions set forth in this document.
11. This document shall not be reprinted, reproduced or duplicated in any form, in whole or in part, without prior written consent of Renesas Electronics.
12. Please contact a Renesas Electronics sales office if you have any questions regarding the information contained in this document or Renesas Electronics products.
(Note 1) "Renesas Electronics" as used in this document means Renesas Electronics Corporation and also includes its directly or indirectly controlled subsidiaries.
(Note 2) "Renesas Electronics product(s)" means any product developed or manufactured by or for Renesas Electronics.

(Rev.4.0-1 November 2017)



SALES OFFICES

Renesas Electronics Corporation

<http://www.renesas.com>

Refer to "<http://www.renesas.com/>" for the latest and detailed information.

Renesas Electronics America Inc.
1001 Murphy Ranch Road, Milpitas, CA 95035, U.S.A.
Tel: +1-408-432-8888, Fax: +1-408-434-5351

Renesas Electronics Canada Limited
9251 Yonge Street, Suite 8309 Richmond Hill, Ontario Canada L4C 9T3
Tel: +1-905-237-2004

Renesas Electronics Europe Limited
Dukes Meadow, Millboard Road, Bourne End, Buckinghamshire, SL8 5FH, U.K
Tel: +44-1628-651-700, Fax: +44-1628-651-804

Renesas Electronics Europe GmbH
Arcadiastrasse 10, 40472 Düsseldorf, Germany
Tel: +49-211-6503-0, Fax: +49-211-6503-1327

Renesas Electronics (China) Co., Ltd.
Room 1709 Quantum Plaza, No.27 ZhichunLu, Haidian District, Beijing, 100191 P. R. China
Tel: +86-10-8235-1155, Fax: +86-10-8235-7679

Renesas Electronics (Shanghai) Co., Ltd.
Unit 301, Tower A, Central Towers, 555 Langao Road, Putuo District, Shanghai, 200333 P. R. China
Tel: +86-21-2226-0888, Fax: +86-21-2226-0999

Renesas Electronics Hong Kong Limited
Unit 1601-1611, 16/F., Tower 2, Grand Century Place, 193 Prince Edward Road West, Mongkok, Kowloon, Hong Kong
Tel: +852-2265-6688, Fax: +852-2886-9022

Renesas Electronics Taiwan Co., Ltd.
13F, No. 363, Fu Shing North Road, Taipei 10543, Taiwan
Tel: +886-2-8175-9600, Fax: +886-2-8175-9670

Renesas Electronics Singapore Pte. Ltd.
80 Bendemeer Road, Unit #06-02 Hyflux Innovation Centre, Singapore 339949
Tel: +65-6213-0200, Fax: +65-6213-0300

Renesas Electronics Malaysia Sdn.Bhd.
Unit 1207, Block B, Menara Amcorp, Amcorp Trade Centre, No. 18, Jln Persiaran Barat, 46050 Petaling Jaya, Selangor Darul Ehsan, Malaysia
Tel: +60-3-7955-9390, Fax: +60-3-7955-9510

Renesas Electronics India Pvt. Ltd.
No.777C, 100 Feet Road, HAL 2nd Stage, Indiranagar, Bangalore 560 038, India
Tel: +91-80-67208700, Fax: +91-80-67208777

Renesas Electronics Korea Co., Ltd.
17F, KAMCO Yangjae Tower, 262, Gangnam-daero, Gangnam-gu, Seoul, 06265 Korea
Tel: +82-2-558-3737, Fax: +82-2-558-5338