

ISL70444SEH

Single Event Effects Testing

AN1838
Rev.1.00
Jun 22, 2017

Introduction

There are many phenomena that occur past Earth's atmosphere that commercial integrated circuits do not encounter. Among these, we have effects that can cause a variety of transient and destructive effects in analog circuits; these are termed Single Event Latch-up (SEL), Single Event Burnout (SEB), and Single Event Transients (SET). Collectively they are called Single Event Effects (SEE). SEE can lead to system level failures including the disruption in normal operation as well as permanent damage. For a device to be deemed reliable under heavy ion environments, it should be designed from the ground up with SEE hardness in mind. It will then undergo extensive SEE testing which then validates the design. This report discusses the results of SEE testing for the [ISL70444SEH](#).

Related Literature

- For a full list of related documents, visit our website
 - [ISL70444SEH](#) product page
 - ISL70444SEH Radiation Report

Product Description

The ISL70444SEH features four low-power amplifiers optimized to provide maximum dynamic range. This op amp features a common-mode input voltage range that goes all the way to the rails and a rail-to-rail output voltage swing.

The ISL70444SEH also offers low power, low offset voltage, and low temperature drift, making it ideal for applications requiring both high DC accuracy and AC performance. This amplifier is designed to operate over a single supply range of 2.7V to 40V or a split supply voltage range of $\pm 1.35V$ to $\pm 20V$. Applications for this amplifier include precision instrumentation, data acquisition, precision power supply controls, and process controls.

The ISL70444SEH is available in a 14 Ld hermetic ceramic flatpack and operates across the extended temperature range of $-55^{\circ}C$ to $+125^{\circ}C$. A summary of the op amp features is as follows:

- Rail-to-Rail on Input/Output (RRIO) operation
- Wide gain-bandwidth product 19MHz
- Low input offset voltage 300 μ V
- Low current consumption (per amp) 1.1mA, Typ.
- Enhanced large signal SR 60V/ μ s

SEE Results Objective

The objective of the SEE testing was to evaluate the ISL70444SEH's Single Event Transient (SET) behavior and its susceptibility to destructive events induced by single event effects such as Single Event Burnout (SEB).

SEE Testing Facility

Testing for the ISL70444SEH was conducted at Texas A&M University (TAMU) Cyclotron Institute, Heavy Ion Facility. This facility is coupled with a K500 super-conducting cyclotron which is capable of generating a wide range of test particles with various energy, flux, and fluence levels needed for advanced radiation testing.

SEE Testing Procedure

The ISL70444SEH was tested for Single Event Burnout (SEB) using Au ions at normal incidence ($LET = 86.4MeV \cdot cm^2/mg$) with a case temperature of $+125^{\circ}C$ and Single Event Transient with a gain of 10 using Ne, Ar, Kr, Ag, Pr and Au, and gain of 1 with Kr and Pr, which provided the range of LET values needed for the tests. In both cases the case temperature was $+25^{\circ}C$.

The Device Under Test (DUT) was mounted in 14 lead dual in-line packages with the lid removed. It was then placed in the beam line and irradiated with heavy ions of the appropriate species. The beam was directed onto the exposed die and the beam flux, beam fluence and error in device outputs were monitored. There were eight parts in total, SN1 through SN4 were used for SEB testing and SN5-SN8 were used for SET testing.

The testing of the ISL70444SEH was conducted remotely from the control room at TAMU. Power to the DUT was supplied through bench-top power supplies and connected using heavy gauge stranded wires to minimize loss. The supply currents were monitored along with device outputs. Supply currents were monitored using digital ammeters and device outputs were monitored using an oscilloscope to help identify how the part reacted to various SEE. Events were captured by triggering on deviations in the output.

SEE Test Setup Diagrams

[Figures 1](#) and [2](#) show the evaluation board setup that was used during testing.

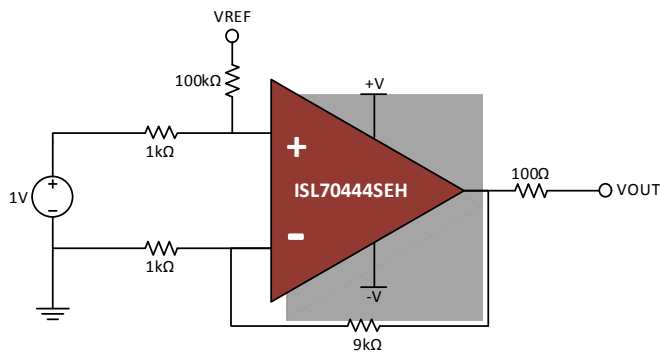

FIGURE 1. ISL70444SEH CONFIGURATION (GAIN OF 10)

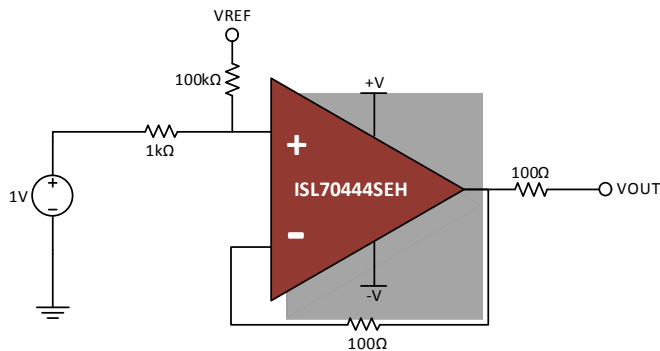

FIGURE 2. ISL70444SEH CONFIGURATION (GAIN OF 1)

The ISL70444SEH was tested under two conditions, gain of 10 (Figure 1) and gain of 1 (Figure 2). Under each condition, each channel of the quad amplifier was configured identically and VREF was left to float. A 100Ω series resistor was used to shield the amplifier from cable capacitance. A more detailed board schematic and layout of the evaluation board can be referenced in ["Appendix A" on page 22](#).

Cross Section Calculations

Cross Sections (CS) are calculated as shown by [Equation 1](#):

$$CS_{(LET)} = \frac{N}{F} \quad (\text{EQ. 1})$$

where:

CS is the SET cross section in cm^2 , expressed as a function of the heavy ion LET.

LET is the linear energy transfer in $\text{MeV} \cdot \text{cm}^2/\text{mg}$

N is the total number of SET events

F is the fluence in particles/ cm^2

A value of $1/F$ is the assumed cross section when no event is observed.

Single Event Burnout (SEB) Results

The first test in the sequence was to look for destructive events due to SEB. A failure due to burnout was indicated by a permanent change in the part's supply current after the beam was turned off. If the supply current reverted back to its pre-radiation value after a power cycle, the event was then deemed as latch-up. The ISL70444SEH did not have any latch-up events; this can be attributed to the SOI construction of the process and therefore, it is latch-up immune.

No burnout was observed for the ISL70444SEH when using Au ions at normal incidence. Testing was performed on four parts at a T_C of $+125^\circ\text{C}$ using the schematic shown in [Figure 1](#). The common voltage at which each part passed to was $\pm 21V_{\text{SUPPLY}}$. SN1 and SN4 both passed to $\pm 23V$, while SN3 passed to $\pm 22V$ and SN2 passed to $\pm 21V$. Each part was started at $\pm 18V$ and stepped up in increments until they failed. All test runs were run in a gain of 10 to a fluence of $2 \times 10^6/\text{cm}^2$ with an input of 100mV applied to the non-inverting input of the amplifiers. After each run, the functionality of the op amp was verified by monitoring the outputs of all amplifiers with an oscilloscope. IDD and IEE were recorded pre- and post-exposure and then summed up, a $\pm 5\%$ delta (to allow for measurement repeatability) would indicate a failure. [Table 1](#) shows the SEB results for the ISL70444SEH for a supply voltage of $\pm 21V$.

TABLE 1. SEB RESULTS (FLUENCE = $2 \times 10^6/\text{cm}^2$) WITH NO DESTRUCTIVE OR LATCH EVENTS; ALL PARTS PASSED TO $V_S = \pm 21V$

| SN | TEMP (°C) | PRE-EXPOSURE | | POST EXPOSURE | | SEB/L |
|----|--------------|--------------|---------|---------------|---------|-------|
| | | I- (mA) | I+ (mA) | I- (mA) | I+ (mA) | |
| 1 | +125 | 8.92 | 8.56 | 8.94 | 8.57 | PASS |
| 2 | +125 | 10.95 | 10.53 | 10.47 | 10.14 | PASS |
| 3 | +125 | 7.41 | 7.04 | 7.39 | 7.02 | PASS |
| 4 | +125 | 15.28 | 14.97 | 15.57 | 15.20 | PASS |

Single Event Transient (SET) Results

TEST SETUP (GAIN OF 1)

Two devices were tested at two different supply voltages, $V_S = \pm 1.35V$ and $V_S = \pm 15V$. The non-inverting inputs for all amplifiers were set to 1V for $V_S = \pm 1.35V$ and 2V for $V_S = \pm 15V$. The outputs were monitored from the control room with four LeCroy oscilloscopes. Summary of the scope settings is as follows:

Trigger Connections

- Scope 1 triggered on Channel A
- Scope 2 triggered on Channel B
- Scope 3 triggered on Channel C
- Scope 4 triggered on Channel D

SET events were recorded whenever the output deviated from a trigger window during beam exposure. The window was $\pm 100mV$ ($\pm 1\%$ of V_{OUT}) for $V_S = \pm 1.35V$ and $\pm 200mV$ ($\pm 1\%$ of V_{OUT}) for $V_S = \pm 15V$. The volts per division on each captured trace was 1V/div for $V_S = \pm 1.35V$ and 5V/div for $V_S = \pm 15V$. During post-processing, transient durations are defined as any voltage transient in excess of $\pm 10mV$ from V_{OUT} . The time spent $\pm 10mV$ away from V_{OUT} is then summed up and presented in histograms in [Figures 3](#) and [4](#). Positive and negative voltage deviations were recorded separately from each other.

Cross Section Results

The results shown in [Tables 2](#) and [3](#) are the cross sectional results for the 2 devices that were tested in unity gain at LET = 28 and 60MeV•cm²/mg. It appears that in this case the higher supply voltage of $\pm 15V$ had a lower cross section.

TABLE 2. SET CROSS SECTION RESULTS OF ISL70444SEH IN UNITY GAIN ($V_S = \pm 1.5V$); TRIGGER WINDOW = $\pm 100mV$

| SUPPLY (V) | SPECIES | LET (MeV•cm ² /mg) | ANGLE (°) | CHANNEL | DEVICE | FLUENCE/RUN (P/cm ²) | TOTAL SET | EVENT CS (cm ²) |
|-------------|---------|-------------------------------|-----------|---------|--------|----------------------------------|-----------|-----------------------------|
| $\pm 1.35V$ | Kr | 28 | 0 | A | 6 | 1.00E+06 | 502 | 5.02E-04 |
| $\pm 1.35V$ | Pr | 28 | 0 | A | 7 | 1.00E+06 | 502 | 5.02E-04 |
| $\pm 1.35V$ | Kr | 60 | 0 | A | 6 | 1.00E+06 | 541 | 5.41E-04 |
| $\pm 1.35V$ | Pr | 60 | 0 | A | 7 | 1.00E+06 | 678 | 6.78E-04 |
| $\pm 1.35V$ | Kr | 28 | 0 | B | 6 | 1.00E+06 | 533 | 5.33E-04 |
| $\pm 1.35V$ | Pr | 28 | 0 | B | 7 | 1.00E+06 | 538 | 5.38E-04 |
| $\pm 1.35V$ | Kr | 60 | 0 | B | 6 | 1.00E+06 | 680 | 6.80E-04 |
| $\pm 1.35V$ | Pr | 60 | 0 | B | 7 | 1.00E+06 | 714 | 7.14E-04 |
| $\pm 1.35V$ | Kr | 28 | 0 | C | 6 | 1.00E+06 | 334 | 3.34E-04 |
| $\pm 1.35V$ | Pr | 28 | 0 | C | 7 | 1.00E+06 | 294 | 2.94E-04 |
| $\pm 1.35V$ | Kr | 60 | 0 | C | 6 | 1.00E+06 | 371 | 3.71E-04 |
| $\pm 1.35V$ | Pr | 60 | 0 | C | 7 | 1.00E+06 | 323 | 3.23E-04 |
| $\pm 1.35V$ | Kr | 28 | 0 | D | 6 | 1.00E+06 | 478 | 4.78E-04 |
| $\pm 1.35V$ | Pr | 28 | 0 | D | 7 | 1.00E+06 | 449 | 4.49E-04 |
| $\pm 1.35V$ | Kr | 60 | 0 | D | 6 | 1.00E+06 | 534 | 5.34E-04 |
| $\pm 1.35V$ | Pr | 60 | 0 | D | 7 | 1.00E+06 | 500 | 5.00E-04 |

TABLE 3. SET CROSS SECTION RESULTS OF ISL70444SEH IN UNITY GAIN ($V_S = \pm 15V$); TRIGGER WINDOW = $\pm 200mV$

| SUPPLY (V) | SPECIES | LET (MeV • cm ² /mg) | ANGLE (°) | CHANNEL | DEVICE | FLUENCE/RUN (P/cm ²) | TOTAL SET | EVENT CS (cm ²) |
|------------|---------|---------------------------------|-----------|---------|--------|----------------------------------|-----------|-----------------------------|
| ±15 | Kr | 28 | 0 | A | 6 | 1.00E+06 | 355 | 3.55E-04 |
| ±15 | Pr | 28 | 0 | A | 7 | 1.00E+06 | 328 | 3.28E-04 |
| ±15 | Kr | 60 | 0 | A | 6 | 2.00E+06 | 1027 | 5.14E-04 |
| ±15 | Pr | 60 | 0 | A | 7 | 1.00E+06 | 629 | 6.29E-04 |
| ±15 | Kr | 28 | 0 | B | 6 | 1.00E+06 | 362 | 3.62E-04 |
| ±15 | Pr | 28 | 0 | B | 7 | 1.00E+06 | 316 | 3.16E-04 |
| ±15 | Kr | 60 | 0 | B | 6 | 1.00E+06 | 673 | 6.73E-04 |
| ±15 | Pr | 60 | 0 | B | 7 | 1.00E+06 | 620 | 6.20E-04 |
| ±15 | Kr | 28 | 0 | C | 6 | 1.00E+06 | 248 | 2.48E-04 |
| ±15 | Pr | 28 | 0 | C | 7 | 1.00E+06 | 254 | 2.54E-04 |
| ±15 | Kr | 60 | 0 | C | 6 | 1.00E+06 | 392 | 3.92E-04 |
| ±15 | Pr | 60 | 0 | C | 7 | 1.00E+06 | 340 | 3.40E-04 |
| ±15 | Kr | 28 | 0 | D | 6 | 1.00E+06 | 330 | 3.30E-04 |
| ±15 | Pr | 28 | 0 | D | 7 | 1.00E+06 | 309 | 3.09E-04 |
| ±15 | Kr | 60 | 0 | D | 6 | 1.00E+06 | 531 | 5.31E-04 |
| ±15 | Pr | 60 | 0 | D | 7 | 1.00E+06 | 464 | 4.64E-04 |

SET Characteristics

Figures 3 through 8 are histograms that describe the characteristics of transients caused by SETs. Figures 3 and 4 describe the duration of the SETs at $V_S = \pm 1.35V$ and $V_S = \pm 15V$, respectively. Figures 5 and 6 describe the maximum positive voltage deviation from V_{OUT} during an SET at $V_S = \pm 1.35V$ and $V_S = \pm 15V$, respectively. Figures 7 and 8 describe the maximum negative voltage deviation from V_{OUT} during an SET at $V_S = \pm 1.35V$ and $V_S = \pm 15V$, respectively. For $V_S = \pm 1.35V$, recovery time from SETs were always within $2\mu s$. For $V_S = \pm 15V$, recovery time was much faster ($\leq 400ns$).

For the composite pictures in Figures 9 through 12 the first 200 captures at each LET and power supply setting were plotted on top of each other to show an envelope of how the ISL70444SEH reacts during SETs for LET = 28 and 60MeV • cm²/mg.

Transient Duration Histograms

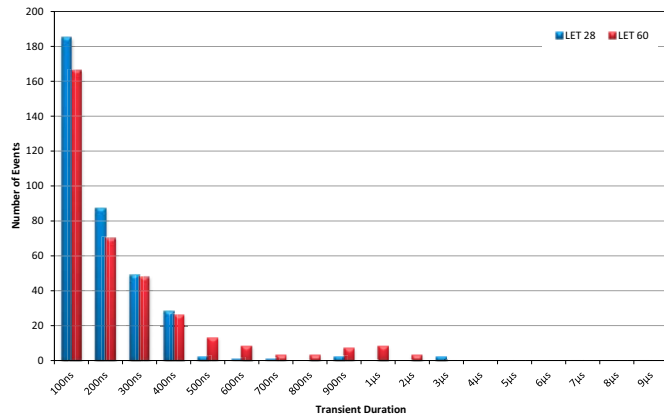

FIGURE 3. TRANSIENT DURATIONS CAUSED BY SETs ($V_S = \pm 1.35V$) AT LET = 28 AND $60MeV \cdot cm^2/mg$ WITH FLUENCE OF $2 \times 10^6/cm^2$; SETs ARE DEFINED AS A PULSE IN EXCESS OF $\pm 10mV$ FROM V_{OUT} DURING POST-PROCESSING

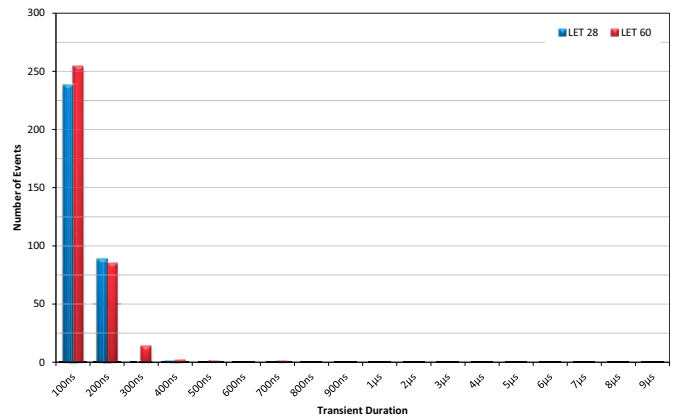

FIGURE 4. TRANSIENT DURATIONS CAUSED BY SETs ($V_S = \pm 15V$) AT LET = 28 AND $60MeV \cdot cm^2/mg$ WITH FLUENCE OF $2 \times 10^6/cm^2$; SETs ARE DEFINED AS A PULSE IN EXCESS OF $\pm 10mV$ FROM V_{OUT} DURING POST-PROCESSING

Positive Voltage Deviation Histograms

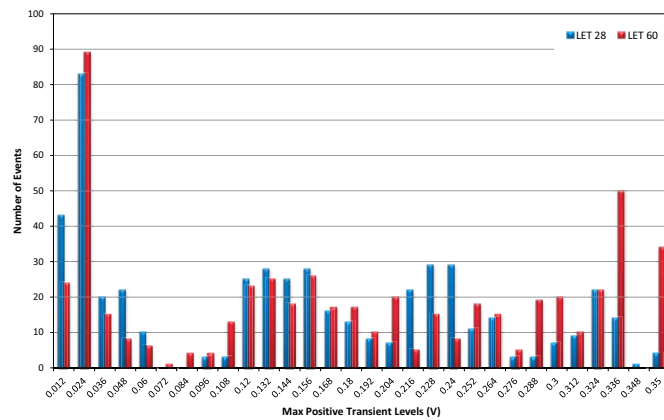

FIGURE 5. MAX POSITIVE TRANSIENT VOLTAGE FROM $V_{OUT} = +1V$ CAUSED BY SETs ($V_S = \pm 1.35V$); LET = 28 AND $60MeV \cdot cm^2/mg$ WITH FLUENCE OF $2 \times 10^6/cm^2$

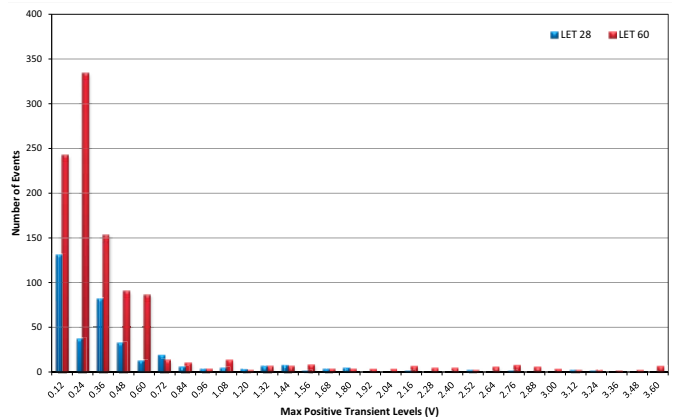

FIGURE 6. MAX POSITIVE TRANSIENT VOLTAGE FROM $V_{OUT} = +2V$ CAUSED BY SETs ($V_S = \pm 15V$); LET = 28 AND $60MeV \cdot cm^2/mg$ WITH FLUENCE OF $2 \times 10^6/cm^2$

Negative Voltage Deviation Histograms

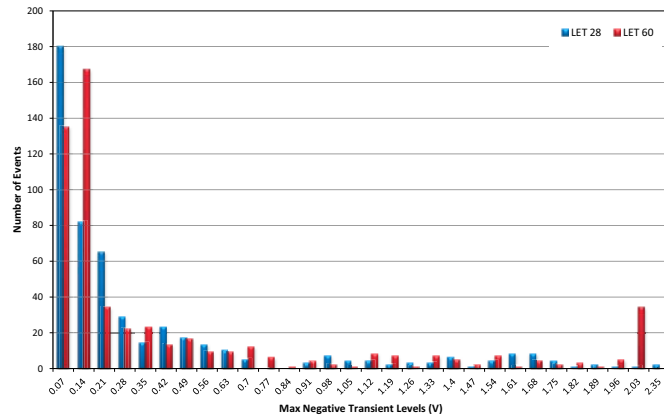

FIGURE 7. MAX NEGATIVE TRANSIENT VOLTAGE FROM $V_{OUT} = +1V$ CAUSED BY SETs ($V_S = \pm 1.35V$); LET = 28 AND $60MeV \cdot cm^2/mg$ WITH FLUENCE OF $2 \times 10^6/cm^2$

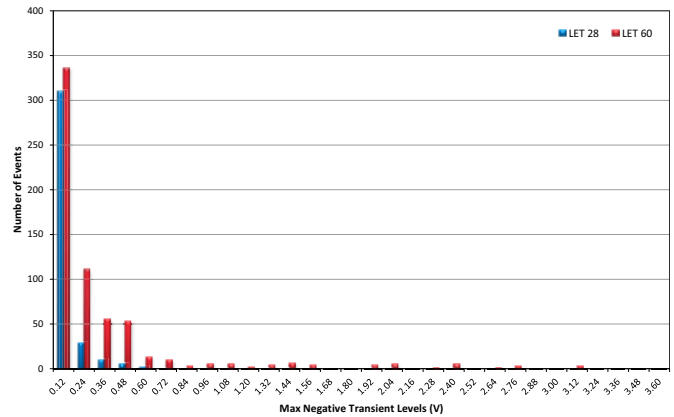

FIGURE 8. MAX NEGATIVE TRANSIENT VOLTAGE FROM $V_{OUT} = +2V$ CAUSED BY SETs ($V_S = \pm 15V$); LET = 28 AND $60MeV \cdot cm^2/mg$ WITH FLUENCE OF $2 \times 10^6/cm^2$

SET Composite Plots (Unity Gain)

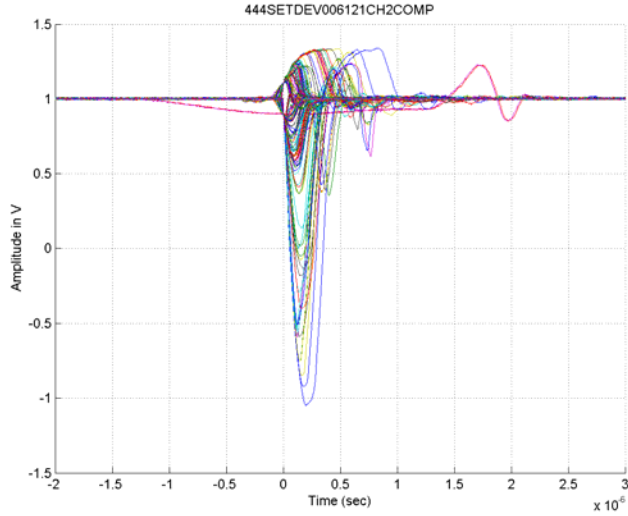

FIGURE 9. LET = 28MeV • cm²/mg (V_S = ±1.35V)

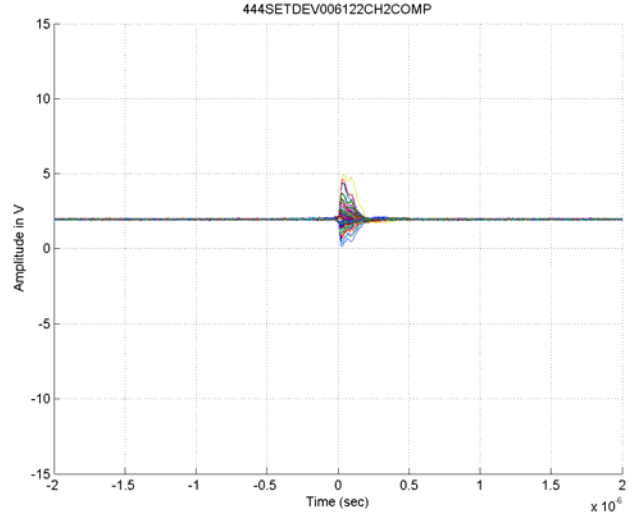

FIGURE 10. LET = 28MeV • cm²/mg (V_S = ±15V)

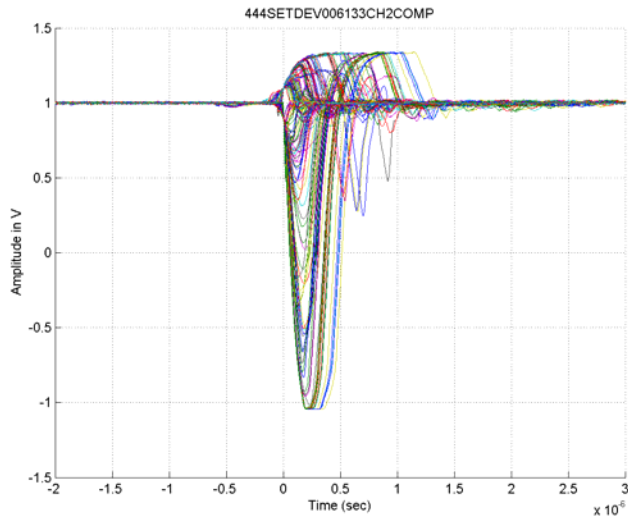

FIGURE 11. LET = 60MeV • cm²/mg (V_S = ±1.35V)

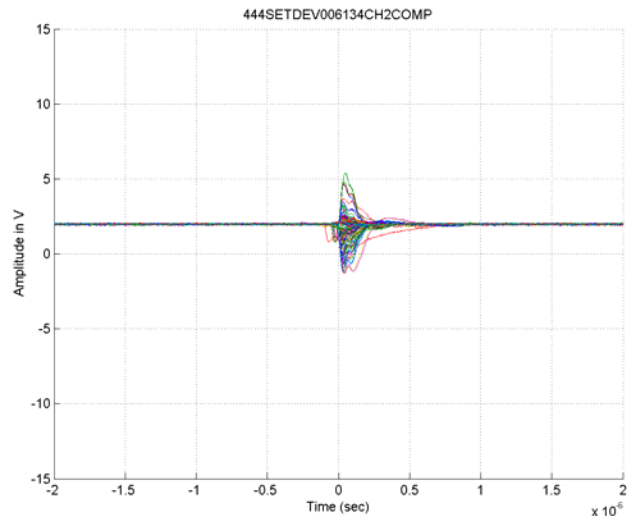

FIGURE 12. LET = 60MeV • cm²/mg (V_S = ±15V)

TEST SETUP (GAIN OF 10)

There is a definite advantage for high speed op amps in applications that use gains greater than 1, as they still provide ample bandwidth comparatively while in a gained configuration. As most applications tend to use high speed op amps with gains higher than 1, a worst case analysis was studied at several more SETs with ACL = 10. For this worst case analysis, SETs were defined as a $\pm 1V$ deviation at $V_S = \pm 15V$ and $\pm 200mV$ for $V_S = \pm 1.35V$ to showcase the ultra fast recovery time of the ISL70444SEH under drastic changes ($\leq 5\mu s$ in all cases). During post-processing, transient durations are defined as any voltage transient that crosses $\pm 10mV$ from V_{OUT} . The time spent $\pm 10mV$ away from V_{OUT} is then summed up and presented in histograms in [Figures 24](#) and [27](#) for their respective test conditions. Positive and negative voltage deviations were recorded separately from each other illustrated in [Figures 22, 23, 25, and 26](#).

The non-inverting inputs for all amplifiers were set to 1V. The outputs were monitored from the control room with four LeCroy oscilloscopes. Summary of the scope settings is as follows:

TRIGGER CONNECTIONS

- Scope 1 triggered on Channel A
- Scope 2 triggered on Channel B
- Scope 3 triggered on Channel C
- Scope 4 triggered on Channel D

CHANNEL CONNECTION ON ALL SCOPES ($V_S = \pm 1.35V$)

- CH1 through CH4 = 1V/div (OUTA through OUTD)

CHANNEL CONNECTION ON ALL SCOPES ($V_S = \pm 15V$)

- CH1 through CH4 = 5V/div (OUTA through OUTD)

Cross Section Results

Unlike other Intersil radiation tolerant circuits, the ISL70444SEH was not designed with Single Event Transient mitigation. The best approach to characterize the SET response is to represent the data on a LET threshold plot (shown in [Figure 13](#)).

As it can be seen, $V_S = \pm 15V$ has a lower SET cross section across all tested LET levels compared to $V_S = \pm 1.35V$. The data represented in [Figure 13](#) is shown in tabular form in [Table 4](#).

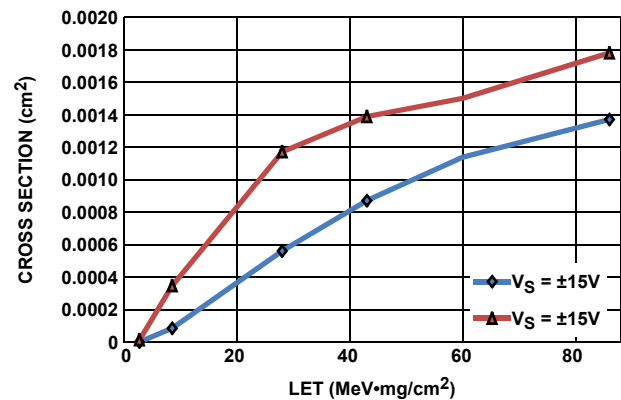

FIGURE 13. SET CROSS SECTION vs LET vs SUPPLY VOLTAGE

TABLE 4. DETAILS OF LET THRESHOLD PLOT; TRIGGER WINDOWS DEFINED IN TEST SETUP (GAIN OF 10)

| SUPPLY (V) | SPECIES | LET (MeV·cm ² /mg) | ANGLE (°) | RUNS | FLUENCE/RUN (P/cm ²) | TOTAL SET | EVENT CS (cm ²) |
|-------------|---------|-------------------------------|-----------|------|----------------------------------|-----------|-----------------------------|
| $\pm 1.35V$ | Ne | 2.7 | 0 | 4 | 2.00E+06 | 126 | 1.58E-05 |
| $\pm 1.35V$ | Ar | 8.5 | 0 | 4 | 2.00E+06 | 2789 | 3.49E-04 |
| $\pm 1.35V$ | Kr | 28 | 0 | 4 | 2.00E+06 | 9385 | 1.17E-03 |
| $\pm 1.35V$ | Ag | 43 | 0 | 4 | 2.00E+06 | 11121 | 1.39E-03 |
| $\pm 1.35V$ | Pr | 60 | 0 | 4 | 2.00E+06 | 12015 | 1.50E-03 |
| $\pm 1.35V$ | Au | 86 | 0 | 4 | 2.00E+06 | 14257 | 1.78E-03 |
| $\pm 15.0V$ | Ne | 2.7 | 0 | 4 | 2.00E+06 | 19 | 2.38E-06 |
| $\pm 15.0V$ | Ar | 8.5 | 0 | 4 | 2.00E+06 | 693 | 8.66E-05 |
| $\pm 15.0V$ | Kr | 28 | 0 | 4 | 2.00E+06 | 4501 | 5.63E-04 |
| $\pm 15.0V$ | Ag | 43 | 0 | 4 | 2.00E+06 | 6981 | 8.73E-04 |
| $\pm 15.0V$ | Pr | 60 | 0 | 4 | 2.00E+06 | 9119 | 1.14E-03 |
| $\pm 15.0V$ | Au | 86 | 0 | 4 | 2.00E+06 | 10974 | 1.37E-03 |

Figures 14 through 17 provide the cross section vs LET on a channel-by-channel basis for $V_S = \pm 1.35V$, while Figures 18 through 21 provide the cross section vs LET channel-by-channel for $V_S = \pm 15V$. At each given LET, the cross section for each of the four devices tested are provided along with the summed average cross section of all devices shown in red for $V_S = \pm 1.35V$ and blue for $V_S = \pm 15V$. The tabular data for Figures 14 through 21 is provided for convenience in Tables 5 through 12.

SET Characteristics

Figures 22, 23, and 24 describe the positive transient voltage spikes, negative transient voltage spikes and transient durations respectively caused by SETs vs LET at $V_S = \pm 15V$. Figures 25, 26, and 27 are identical except with supplies at $V_S = \pm 1.35V$.

For the composite pictures in Figures 28 through 39 the first 200 captures at each LET and power supply setting were plotted on top of each other to show an envelope of how the ISL70444SEH reacts during SETs for LET = 2.7, 8.5, 28, 43, 60, and 86MeV • cm²/mg.

Cross Section Results: $\pm 1.35V$ (Channel-by-Channel)

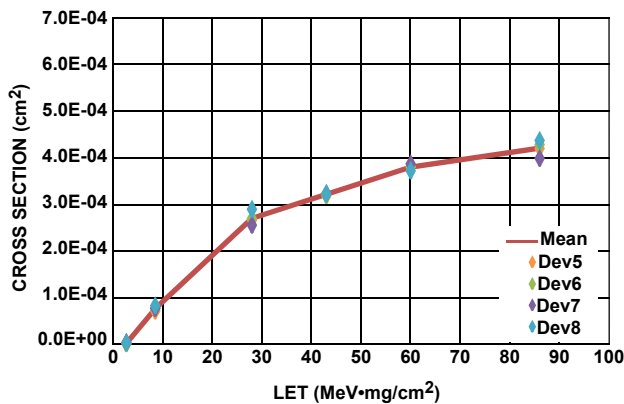

FIGURE 14. CHANNEL A SET CROSS SECTION vs LET ($V_S = \pm 1.35V$)
ACL = 10

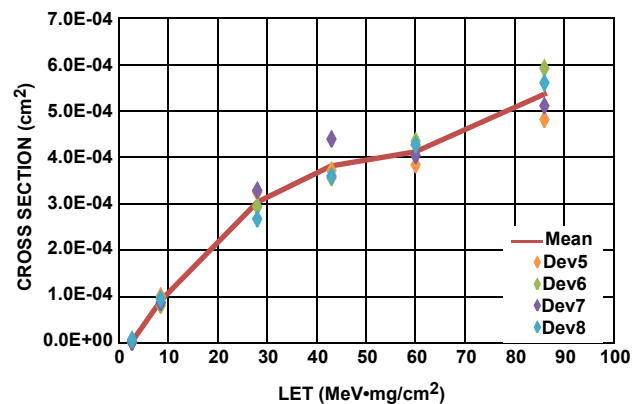

FIGURE 15. CHANNEL A SET CROSS SECTION vs LET ($V_S = \pm 1.35V$)
ACL = 10

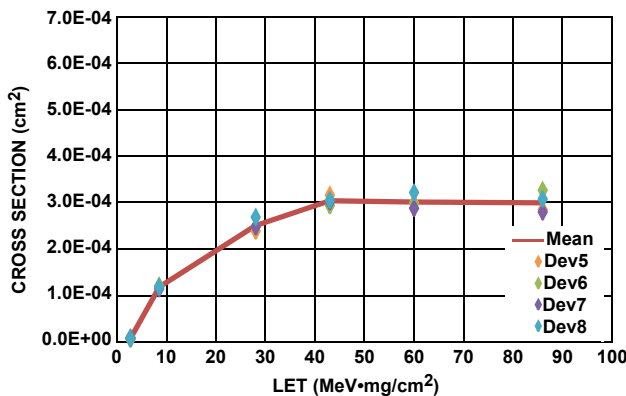

FIGURE 16. CHANNEL C SET CROSS SECTION vs LET ($V_S = \pm 1.35V$)
ACL = 10

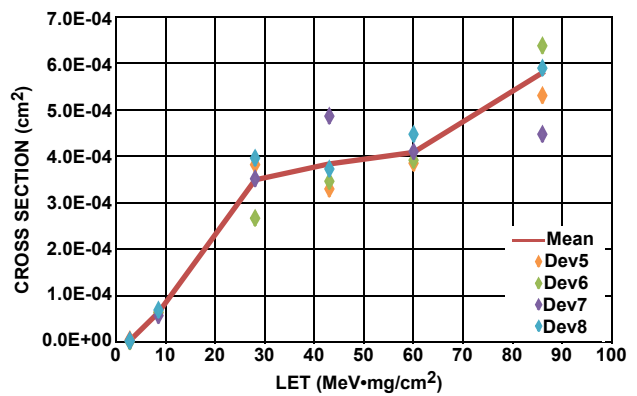

FIGURE 17. CHANNEL D SET CROSS SECTION vs LET ($V_S = \pm 1.35V$)
ACL = 10

Cross Section Results: ±15V (Channel-by-Channel)

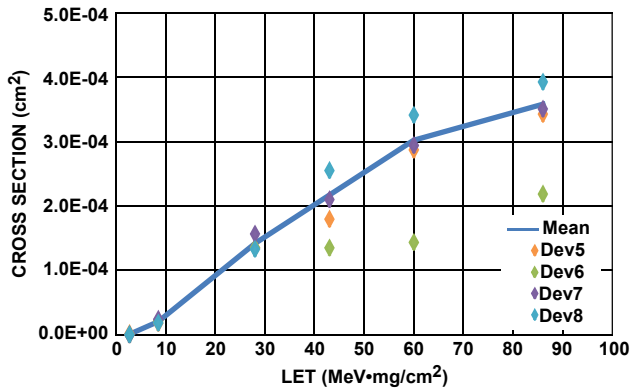

FIGURE 18. CHANNEL A SET CROSS SECTION vs LET ($V_S = \pm 15V$)
ACL = 10

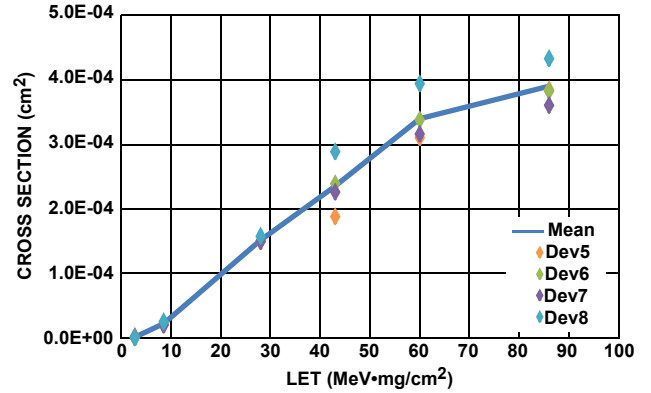

FIGURE 19. CHANNEL B SET CROSS SECTION vs LET ($V_S = \pm 15V$)
ACL = 10

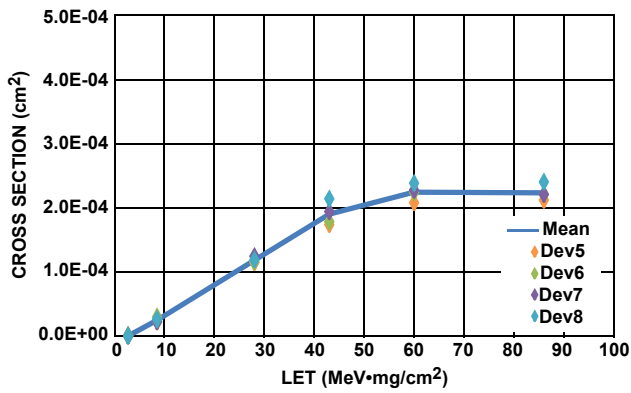

FIGURE 20. CHANNEL C SET CROSS SECTION vs LET ($V_S = \pm 15V$)
ACL = 10

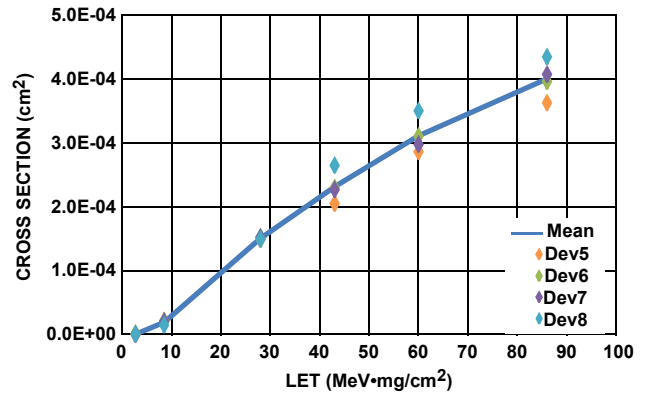

FIGURE 21. CHANNEL D SET CROSS SECTION vs LET ($V_S = \pm 15V$)
ACL = 10

Tabular Cross Section Results: $\pm 1.35V$, ACL = 10 (Channel-by-Channel)TABLE 5. DATA OF CHANNEL CROSS SECTION OF ISL70444SEH FOR $V_S = \pm 1.35V$ (DEVICE 5)

| SUPPLY (V) | SPECIES | LET (MeV • cm ² /mg) | CH | DEVICE | FLUENCE/RUN (P/cm ²) | EVENTS | EVENT CS (cm ²) |
|------------|---------|---------------------------------|----|--------|----------------------------------|--------|-----------------------------|
| ± 1.35 | Ne | 2.7 | A | 5 | 2.00E+06 | 3 | 1.50E-06 |
| ± 1.35 | Ar | 8.5 | A | 5 | 2.00E+06 | 141 | 7.05E-05 |
| ± 1.35 | Kr | 28 | A | 5 | 2.00E+06 | 531 | 2.66E-04 |
| ± 1.35 | Ag | 43 | A | 5 | 2.00E+06 | 639 | 3.20E-04 |
| ± 1.35 | Pr | 60 | A | 5 | 2.00E+06 | 759 | 3.80E-04 |
| ± 1.35 | Au | 86 | A | 5 | 2.00E+06 | 839 | 4.20E-04 |
| ± 1.35 | Ne | 2.7 | B | 5 | 2.00E+06 | 8 | 4.00E-06 |
| ± 1.35 | Ar | 8.5 | B | 5 | 2.00E+06 | 202 | 1.01E-04 |
| ± 1.35 | Kr | 28 | B | 5 | 2.00E+06 | 650 | 3.25E-04 |
| ± 1.35 | Ag | 43 | B | 5 | 2.00E+06 | 744 | 3.72E-04 |
| ± 1.35 | Pr | 60 | B | 5 | 2.00E+06 | 768 | 3.84E-04 |
| ± 1.35 | Au | 86 | B | 5 | 2.00E+06 | 963 | 4.82E-04 |
| ± 1.35 | Ne | 2.7 | C | 5 | 2.00E+06 | 12 | 6.00E-06 |
| ± 1.35 | Ar | 8.5 | C | 5 | 2.00E+06 | 238 | 1.19E-04 |
| ± 1.35 | Kr | 28 | C | 5 | 2.00E+06 | 477 | 2.39E-04 |
| ± 1.35 | Ag | 43 | C | 5 | 2.00E+06 | 632 | 3.16E-04 |
| ± 1.35 | Pr | 60 | C | 5 | 2.00E+06 | 599 | 3.00E-04 |
| ± 1.35 | Au | 86 | C | 5 | 2.00E+06 | 570 | 2.85E-04 |
| ± 1.35 | Ne | 2.7 | D | 5 | 2.00E+06 | 9 | 4.50E-06 |
| ± 1.35 | Ar | 8.5 | D | 5 | 2.00E+06 | 128 | 6.40E-05 |
| ± 1.35 | Kr | 28 | D | 5 | 2.00E+06 | 764 | 3.82E-04 |
| ± 1.35 | Ag | 43 | D | 5 | 2.00E+06 | 659 | 3.30E-04 |
| ± 1.35 | Pr | 60 | D | 5 | 2.00E+06 | 770 | 3.85E-04 |
| ± 1.35 | Au | 86 | D | 5 | 2.00E+06 | 1062 | 5.31E-04 |

TABLE 6. DATA OF CHANNEL CROSS SECTION OF ISL70444SEH FOR $V_S = \pm 1.35V$ (DEVICE 6)

| SUPPLY (V) | SPECIES | LET (MeV • cm ² /mg) | CH | DEVICE | FLUENCE/RUN (P/cm ²) | EVENTS | EVENT CS (cm ²) |
|------------|---------|---------------------------------|----|--------|----------------------------------|--------|-----------------------------|
| ±1.35 | Ne | 2.7 | A | 6 | 2.00E+06 | 1 | 5.00E-07 |
| ±1.35 | Ar | 8.5 | A | 6 | 2.00E+06 | 151 | 7.55E-05 |
| ±1.35 | Kr | 28 | A | 6 | 2.00E+06 | 538 | 2.69E-04 |
| ±1.35 | Ag | 43 | A | 6 | 2.00E+06 | 637 | 3.19E-04 |
| ±1.35 | Pr | 60 | A | 6 | 2.00E+06 | 761 | 3.81E-04 |
| ±1.35 | Au | 86 | A | 6 | 2.00E+06 | 855 | 4.28E-04 |
| ±1.35 | Ne | 2.7 | B | 6 | 2.00E+06 | 3 | 1.50E-06 |
| ±1.35 | Ar | 8.5 | B | 6 | 2.00E+06 | 163 | 8.15E-05 |
| ±1.35 | Kr | 28 | B | 6 | 2.00E+06 | 588 | 2.94E-04 |
| ±1.35 | Ag | 43 | B | 6 | 2.00E+06 | 712 | 3.56E-04 |
| ±1.35 | Pr | 60 | B | 6 | 2.00E+06 | 870 | 4.35E-04 |
| ±1.35 | Au | 86 | B | 6 | 2.00E+06 | 1184 | 5.92E-04 |
| ±1.35 | Ne | 2.7 | C | 6 | 2.00E+06 | 17 | 8.50E-06 |
| ±1.35 | Ar | 8.5 | C | 6 | 2.00E+06 | 241 | 1.21E-04 |
| ±1.35 | Kr | 28 | C | 6 | 2.00E+06 | 496 | 2.48E-04 |
| ±1.35 | Ag | 43 | C | 6 | 2.00E+06 | 587 | 2.94E-04 |
| ±1.35 | Pr | 60 | C | 6 | 2.00E+06 | 594 | 2.97E-04 |
| ±1.35 | Au | 86 | C | 6 | 2.00E+06 | 653 | 3.27E-04 |
| ±1.35 | Ne | 2.7 | D | 6 | 2.00E+06 | 1 | 5.00E-07 |
| ±1.35 | Ar | 8.5 | D | 6 | 2.00E+06 | 126 | 6.30E-05 |
| ±1.35 | Kr | 28 | D | 6 | 2.00E+06 | 533 | 2.67E-04 |
| ±1.35 | Ag | 43 | D | 6 | 2.00E+06 | 692 | 3.46E-04 |
| ±1.35 | Pr | 60 | D | 6 | 2.00E+06 | 783 | 3.92E-04 |
| ±1.35 | Au | 86 | D | 6 | 2.00E+06 | 1276 | 6.38E-04 |

TABLE 7. DATA OF CHANNEL CROSS SECTION OF ISL70444SEH FOR $V_S = \pm 1.35V$ (DEVICE 7)

| SUPPLY (V) | SPECIES | LET (MeV • cm ² /mg) | CH | DEVICE | FLUENCE/RUN (P/cm ²) | EVENTS | EVENT CS (cm ²) |
|------------|---------|---------------------------------|----|--------|----------------------------------|--------|-----------------------------|
| ±1.35 | Ne | 2.7 | A | 7 | 2.00E+06 | 6 | 3.00E-06 |
| ±1.35 | Ar | 8.5 | A | 7 | 2.00E+06 | 153 | 7.65E-05 |
| ±1.35 | Kr | 28 | A | 7 | 2.00E+06 | 510 | 2.55E-04 |
| ±1.35 | Ag | 43 | A | 7 | 2.00E+06 | 645 | 3.23E-04 |
| ±1.35 | Pr | 60 | A | 7 | 2.00E+06 | 773 | 3.87E-04 |
| ±1.35 | Au | 86 | A | 7 | 2.00E+06 | 796 | 3.98E-04 |
| ±1.35 | Ne | 2.7 | B | 7 | 2.00E+06 | 5 | 2.50E-06 |
| ±1.35 | Ar | 8.5 | B | 7 | 2.00E+06 | 175 | 8.75E-05 |
| ±1.35 | Kr | 28 | B | 7 | 2.00E+06 | 658 | 3.29E-04 |
| ±1.35 | Ag | 43 | B | 7 | 2.00E+06 | 879 | 4.40E-04 |
| ±1.35 | Pr | 60 | B | 7 | 2.00E+06 | 808 | 4.04E-04 |
| ±1.35 | Au | 86 | B | 7 | 2.00E+06 | 1022 | 5.11E-04 |
| ±1.35 | Ne | 2.7 | C | 7 | 2.00E+06 | 18 | 9.00E-06 |
| ±1.35 | Ar | 8.5 | C | 7 | 2.00E+06 | 229 | 1.15E-04 |
| ±1.35 | Kr | 28 | C | 7 | 2.00E+06 | 495 | 2.48E-04 |
| ±1.35 | Ag | 43 | C | 7 | 2.00E+06 | 603 | 3.02E-04 |
| ±1.35 | Pr | 60 | C | 7 | 2.00E+06 | 575 | 2.88E-04 |
| ±1.35 | Au | 86 | C | 7 | 2.00E+06 | 559 | 2.80E-04 |
| ±1.35 | Ne | 2.7 | D | 7 | 2.00E+06 | 5 | 2.50E-06 |
| ±1.35 | Ar | 8.5 | D | 7 | 2.00E+06 | 113 | 5.65E-05 |
| ±1.35 | Kr | 28 | D | 7 | 2.00E+06 | 703 | 3.52E-04 |
| ±1.35 | Ag | 43 | D | 7 | 2.00E+06 | 973 | 4.87E-04 |
| ±1.35 | Pr | 60 | D | 7 | 2.00E+06 | 820 | 4.10E-04 |
| ±1.35 | Au | 86 | D | 7 | 2.00E+06 | 1122 | 5.61E-04 |

TABLE 8. DATA OF CHANNEL CROSS SECTION OF ISL70444SEH FOR $V_S = \pm 1.35V$ (DEVICE 8)

| SUPPLY (V) | SPECIES | LET (MeV • cm ² /mg) | CH | DEVICE | FLUENCE/RUN (P/cm ²) | EVENTS | EVENT CS (cm ²) |
|------------|---------|---------------------------------|----|--------|----------------------------------|--------|-----------------------------|
| ±1.35 | Ne | 2.7 | A | 8 | 2.00E+06 | 4 | 2.00E-06 |
| ±1.35 | Ar | 8.5 | A | 8 | 2.00E+06 | 164 | 8.20E-05 |
| ±1.35 | Kr | 28 | A | 8 | 2.00E+06 | 578 | 2.89E-04 |
| ±1.35 | Ag | 43 | A | 8 | 2.00E+06 | 644 | 3.22E-04 |
| ±1.35 | Pr | 60 | A | 8 | 2.00E+06 | 743 | 3.72E-04 |
| ±1.35 | Au | 86 | A | 8 | 2.00E+06 | 873 | 4.37E-04 |
| ±1.35 | Ne | 2.7 | B | 8 | 2.00E+06 | 15 | 7.50E-06 |
| ±1.35 | Ar | 8.5 | B | 8 | 2.00E+06 | 191 | 9.55E-05 |
| ±1.35 | Kr | 28 | B | 8 | 2.00E+06 | 535 | 2.68E-04 |
| ±1.35 | Ag | 43 | B | 8 | 2.00E+06 | 720 | 3.60E-04 |
| ±1.35 | Pr | 60 | B | 8 | 2.00E+06 | 854 | 4.27E-04 |
| ±1.35 | Au | 86 | B | 8 | 2.00E+06 | 1121 | 5.61E-04 |
| ±1.35 | Ne | 2.7 | C | 8 | 2.00E+06 | 15 | 7.50E-06 |
| ±1.35 | Ar | 8.5 | C | 8 | 2.00E+06 | 237 | 1.19E-04 |
| ±1.35 | Kr | 28 | C | 8 | 2.00E+06 | 537 | 2.69E-04 |
| ±1.35 | Ag | 43 | C | 8 | 2.00E+06 | 610 | 3.05E-04 |
| ±1.35 | Pr | 60 | C | 8 | 2.00E+06 | 643 | 3.22E-04 |
| ±1.35 | Au | 86 | C | 8 | 2.00E+06 | 615 | 3.08E-04 |
| ±1.35 | Ne | 2.7 | D | 8 | 2.00E+06 | 4 | 2.00E-06 |
| ±1.35 | Ar | 8.5 | D | 8 | 2.00E+06 | 137 | 6.85E-05 |
| ±1.35 | Kr | 28 | D | 8 | 2.00E+06 | 792 | 3.96E-04 |
| ±1.35 | Ag | 43 | D | 8 | 2.00E+06 | 745 | 3.73E-04 |
| ±1.35 | Pr | 60 | D | 8 | 2.00E+06 | 895 | 4.48E-04 |
| ±1.35 | Au | 86 | D | 8 | 2.00E+06 | 1180 | 5.90E-04 |

Tabular Cross Section Results: $\pm 15V$, ACL = 10 (Channel-by-Channel)TABLE 9. DATA OF CHANNEL CROSS SECTION OF ISL70444SEH FOR $V_S = \pm 15V$ (DEVICE 5)

| SUPPLY (V) | SPECIES | LET (MeV • cm ² /mg) | CH | DEVICE | FLUENCE/RUN (P/cm ²) | EVENTS | EVENT CS (cm ²) |
|------------|---------|---------------------------------|----|--------|----------------------------------|--------|-----------------------------|
| ± 15 | Ne | 2.7 | A | 5 | 2.00E+06 | 4 | 2.00E-06 |
| ± 15 | Ar | 8.5 | A | 5 | 2.00E+06 | 36 | 1.80E-05 |
| ± 15 | Kr | 28 | A | 5 | 2.00E+06 | 270 | 1.35E-04 |
| ± 15 | Ag | 43 | A | 5 | 2.00E+06 | 359 | 1.80E-04 |
| ± 15 | Pr | 60 | A | 5 | 2.00E+06 | 574 | 2.87E-04 |
| ± 15 | Au | 86 | A | 5 | 2.00E+06 | 685 | 3.43E-04 |
| ± 15 | Ne | 2.7 | B | 5 | 2.00E+06 | 4 | 2.00E-06 |
| ± 15 | Ar | 8.5 | B | 5 | 2.00E+06 | 40 | 2.00E-05 |
| ± 15 | Kr | 28 | B | 5 | 2.00E+06 | 300 | 1.50E-04 |
| ± 15 | Ag | 43 | B | 5 | 2.00E+06 | 376 | 1.88E-04 |
| ± 15 | Pr | 60 | B | 5 | 2.00E+06 | 621 | 3.11E-04 |
| ± 15 | Au | 86 | B | 5 | 2.00E+06 | 769 | 3.85E-04 |
| ± 15 | Ne | 2.7 | C | 5 | 2.00E+06 | 0 | 0.00E+00 |
| ± 15 | Ar | 8.5 | C | 5 | 2.00E+06 | 44 | 2.20E-05 |
| ± 15 | Kr | 28 | C | 5 | 2.00E+06 | 229 | 1.15E-04 |
| ± 15 | Ag | 43 | C | 5 | 2.00E+06 | 348 | 1.74E-04 |
| ± 15 | Pr | 60 | C | 5 | 2.00E+06 | 416 | 2.08E-04 |
| ± 15 | Au | 86 | C | 5 | 2.00E+06 | 424 | 2.12E-04 |
| ± 15 | Ne | 2.7 | D | 5 | 2.00E+06 | 0 | 0.00E+00 |
| ± 15 | Ar | 8.5 | D | 5 | 2.00E+06 | 41 | 2.05E-05 |
| ± 15 | Kr | 28 | D | 5 | 2.00E+06 | 297 | 1.49E-04 |
| ± 15 | Ag | 43 | D | 5 | 2.00E+06 | 410 | 2.05E-04 |
| ± 15 | Pr | 60 | D | 5 | 2.00E+06 | 572 | 2.86E-04 |
| ± 15 | Au | 86 | D | 5 | 2.00E+06 | 725 | 3.63E-04 |

TABLE 10. DATA OF CHANNEL CROSS SECTION OF ISL70444SEH FOR $V_S = \pm 15V$ (DEVICE 6)

| SUPPLY (V) | SPECIES | LET (MeV • cm ² /mg) | CH | DEVICE | FLUENCE/RUN (P/cm ²) | EVENTS | EVENT CS (cm ²) |
|------------|---------|---------------------------------|----|--------|----------------------------------|--------|-----------------------------|
| ±15 | Ne | 2.7 | A | 6 | 2.00E+06 | 0 | 0.00E+00 |
| ±15 | Ar | 8.5 | A | 6 | 2.00E+06 | 43 | 2.15E-05 |
| ±15 | Kr | 28 | A | 6 | 2.00E+06 | 287 | 1.44E-04 |
| ±15 | Ag | 43 | A | 6 | 2.00E+06 | 437 | 2.19E-04 |
| ±15 | Pr | 60 | A | 6 | 2.00E+06 | 575 | 2.88E-04 |
| ±15 | Au | 86 | A | 6 | 2.00E+06 | 693 | 3.47E-04 |
| ±15 | Ne | 2.7 | B | 6 | 2.00E+06 | 0 | 0.00E+00 |
| ±15 | Ar | 8.5 | B | 6 | 2.00E+06 | 46 | 2.30E-05 |
| ±15 | Kr | 28 | B | 6 | 2.00E+06 | 300 | 1.50E-04 |
| ±15 | Ag | 43 | B | 6 | 2.00E+06 | 478 | 2.39E-04 |
| ±15 | Pr | 60 | B | 6 | 2.00E+06 | 676 | 3.38E-04 |
| ±15 | Au | 86 | B | 6 | 2.00E+06 | 765 | 3.83E-04 |
| ±15 | Ne | 2.7 | C | 6 | 2.00E+06 | 3 | 1.50E-06 |
| ±15 | Ar | 8.5 | C | 6 | 2.00E+06 | 60 | 3.00E-05 |
| ±15 | Kr | 28 | C | 6 | 2.00E+06 | 232 | 1.16E-04 |
| ±15 | Ag | 43 | C | 6 | 2.00E+06 | 357 | 1.79E-04 |
| ±15 | Pr | 60 | C | 6 | 2.00E+06 | 448 | 2.24E-04 |
| ±15 | Au | 86 | C | 6 | 2.00E+06 | 442 | 2.21E-04 |
| ±15 | Ne | 2.7 | D | 6 | 2.00E+06 | 3 | 1.50E-06 |
| ±15 | Ar | 8.5 | D | 6 | 2.00E+06 | 42 | 2.10E-05 |
| ±15 | Kr | 28 | D | 6 | 2.00E+06 | 304 | 1.52E-04 |
| ±15 | Ag | 43 | D | 6 | 2.00E+06 | 459 | 2.30E-04 |
| ±15 | Pr | 60 | D | 6 | 2.00E+06 | 620 | 3.10E-04 |
| ±15 | Au | 86 | D | 6 | 2.00E+06 | 792 | 3.96E-04 |

TABLE 11. DATA OF CHANNEL CROSS SECTION OF ISL70444SEH for $V_S = \pm 15V$ (DEVICE 7)

| SUPPLY (V) | SPECIES | LET (MeV • cm ² /mg) | CH | DEVICE | FLUENCE/RUN (P/cm ²) | EVENTS | EVENT CS (cm ²) |
|------------|---------|---------------------------------|----|--------|----------------------------------|--------|-----------------------------|
| ±15 | Ne | 2.7 | A | 7 | 2.00E+06 | 0 | 0.00E+00 |
| ±15 | Ar | 8.5 | A | 7 | 2.00E+06 | 48 | 2.40E-05 |
| ±15 | Kr | 28 | A | 7 | 2.00E+06 | 313 | 1.57E-04 |
| ±15 | Ag | 43 | A | 7 | 2.00E+06 | 420 | 2.10E-04 |
| ±15 | Pr | 60 | A | 7 | 2.00E+06 | 588 | 2.94E-04 |
| ±15 | Au | 86 | A | 7 | 2.00E+06 | 701 | 3.51E-04 |
| ±15 | Ne | 2.7 | B | 7 | 2.00E+06 | 2 | 1.00E-06 |
| ±15 | Ar | 8.5 | B | 7 | 2.00E+06 | 40 | 2.00E-05 |
| ±15 | Kr | 28 | B | 7 | 2.00E+06 | 299 | 1.50E-04 |
| ±15 | Ag | 43 | B | 7 | 2.00E+06 | 452 | 2.26E-04 |
| ±15 | Pr | 60 | B | 7 | 2.00E+06 | 632 | 3.16E-04 |
| ±15 | Au | 86 | B | 7 | 2.00E+06 | 721 | 3.61E-04 |
| ±15 | Ne | 2.7 | C | 7 | 2.00E+06 | 0 | 0.00E+00 |
| ±15 | Ar | 8.5 | C | 7 | 2.00E+06 | 45 | 2.25E-05 |
| ±15 | Kr | 28 | C | 7 | 2.00E+06 | 249 | 1.25E-04 |
| ±15 | Ag | 43 | C | 7 | 2.00E+06 | 388 | 1.94E-04 |
| ±15 | Pr | 60 | C | 7 | 2.00E+06 | 455 | 2.28E-04 |
| ±15 | Au | 86 | C | 7 | 2.00E+06 | 442 | 2.21E-04 |
| ±15 | Ne | 2.7 | D | 7 | 2.00E+06 | 0 | 0.00E+00 |
| ±15 | Ar | 8.5 | D | 7 | 2.00E+06 | 40 | 2.00E-05 |
| ±15 | Kr | 28 | D | 7 | 2.00E+06 | 304 | 1.52E-04 |
| ±15 | Ag | 43 | D | 7 | 2.00E+06 | 453 | 2.27E-04 |
| ±15 | Pr | 60 | D | 7 | 2.00E+06 | 595 | 2.98E-04 |
| ±15 | Au | 86 | D | 7 | 2.00E+06 | 814 | 4.07E-04 |

TABLE 12. DATA OF CHANNEL CROSS SECTION OF ISL70444SEH for $V_S = \pm 15V$ (DEVICE 8)

| SUPPLY (V) | SPECIES | LET (MeV • cm ² /mg) | CH | DEVICE | FLUENCE/RUN (P/cm ²) | EVENTS | EVENT CS (cm ²) |
|------------|---------|---------------------------------|----|--------|----------------------------------|--------|-----------------------------|
| ±15 | Ne | 2.7 | A | 8 | 2.00E+06 | 1 | 5.00E-07 |
| ±15 | Ar | 8.5 | A | 8 | 2.00E+06 | 37 | 1.85E-05 |
| ±15 | Kr | 28 | A | 8 | 2.00E+06 | 266 | 1.33E-04 |
| ±15 | Ag | 43 | A | 8 | 2.00E+06 | 510 | 2.55E-04 |
| ±15 | Pr | 60 | A | 8 | 2.00E+06 | 682 | 3.41E-04 |
| ±15 | Au | 86 | A | 8 | 2.00E+06 | 785 | 3.93E-04 |
| ±15 | Ne | 2.7 | B | 8 | 2.00E+06 | 1 | 5.00E-07 |
| ±15 | Ar | 8.5 | B | 8 | 2.00E+06 | 50 | 2.50E-05 |
| ±15 | Kr | 28 | B | 8 | 2.00E+06 | 315 | 1.58E-04 |
| ±15 | Ag | 43 | B | 8 | 2.00E+06 | 577 | 2.89E-04 |
| ±15 | Pr | 60 | B | 8 | 2.00E+06 | 788 | 3.94E-04 |
| ±15 | Au | 86 | B | 8 | 2.00E+06 | 866 | 4.33E-04 |
| ±15 | Ne | 2.7 | C | 8 | 2.00E+06 | 0 | 0.00E+00 |
| ±15 | Ar | 8.5 | C | 8 | 2.00E+06 | 52 | 2.60E-05 |
| ±15 | Kr | 28 | C | 8 | 2.00E+06 | 238 | 1.19E-04 |
| ±15 | Ag | 43 | C | 8 | 2.00E+06 | 428 | 2.14E-04 |
| ±15 | Pr | 60 | C | 8 | 2.00E+06 | 477 | 2.39E-04 |
| ±15 | Au | 86 | C | 8 | 2.00E+06 | 481 | 2.41E-04 |
| ±15 | Ne | 2.7 | D | 8 | 2.00E+06 | 1 | 5.00E-07 |
| ±15 | Ar | 8.5 | D | 8 | 2.00E+06 | 29 | 1.45E-05 |
| ±15 | Kr | 28 | D | 8 | 2.00E+06 | 298 | 1.49E-04 |
| ±15 | Ag | 43 | D | 8 | 2.00E+06 | 529 | 2.65E-04 |
| ±15 | Pr | 60 | D | 8 | 2.00E+06 | 700 | 3.50E-04 |
| ±15 | Au | 86 | D | 8 | 2.00E+06 | 869 | 4.35E-04 |

Voltage Deviation Histograms: ±15V

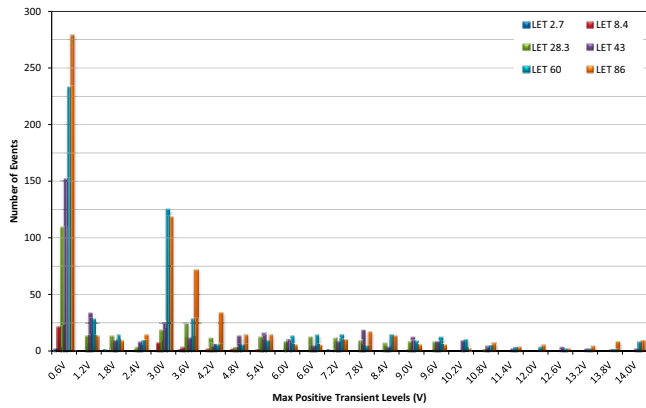

FIGURE 22. MAX POSITIVE VOLTAGE TRANSIENTS FROM $V_{OUT} = +1V$ CAUSED BY SETs ($V_S = \pm 15V$, $ACL = 10$), FLUENCE WAS RUN AT $2 \times 10^6/cm^2$

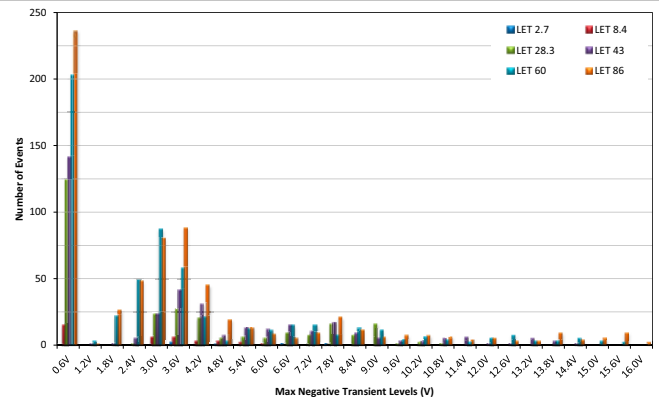

FIGURE 23. MAX NEGATIVE VOLTAGE TRANSIENTS FROM $V_{OUT} = +1V$ CAUSED BY SETs ($V_S = \pm 15V$, $ACL = 10$), FLUENCE WAS RUN AT $2 \times 10^6/cm^2$

Transient Deviation Histogram: ±15V

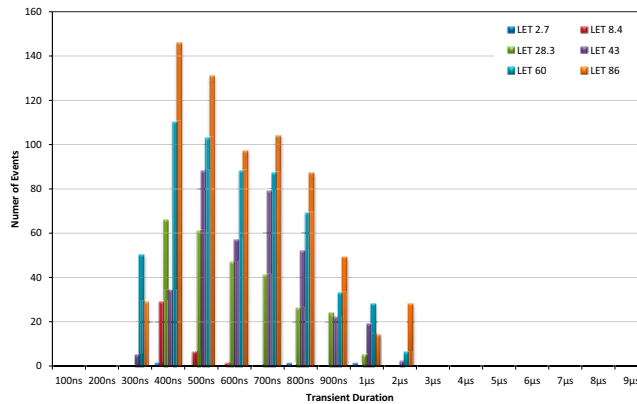

FIGURE 24. MAX TRANSIENT DURATION CAUSED BY SETs ($V_S = \pm 15V$, $ACL = 10$), FLUENCE WAS RUN AT $2 \times 10^6/cm^2$

Voltage Deviation Histograms: ±1.35V

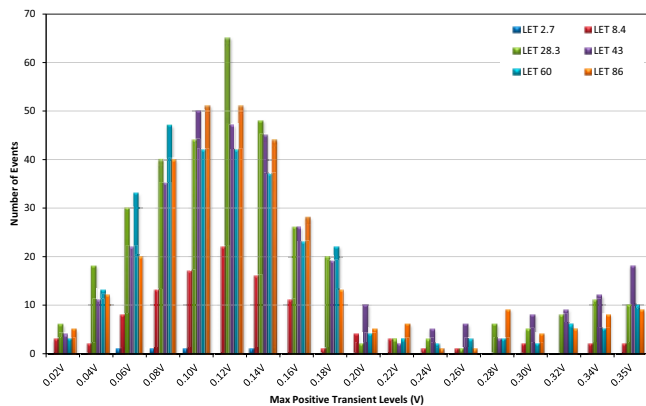

FIGURE 25. MAX POSITIVE VOLTAGE TRANSIENTS FROM $V_{OUT} = +1V$ CAUSED BY SETs ($V_S = \pm 1.35V$, $ACL = 10$), FLUENCE WAS RUN AT $2 \times 10^6/cm^2$

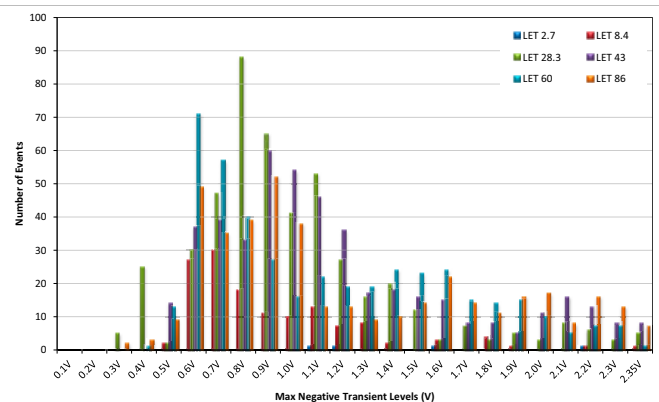

FIGURE 26. MAX NEGATIVE VOLTAGE TRANSIENTS FROM $V_{OUT} = +1V$ CAUSED BY SETs ($V_S = \pm 15V$, $ACL = 10$), FLUENCE WAS RUN AT $2 \times 10^6/cm^2$

Transient Deviation Histogram: $\pm 1.35V$

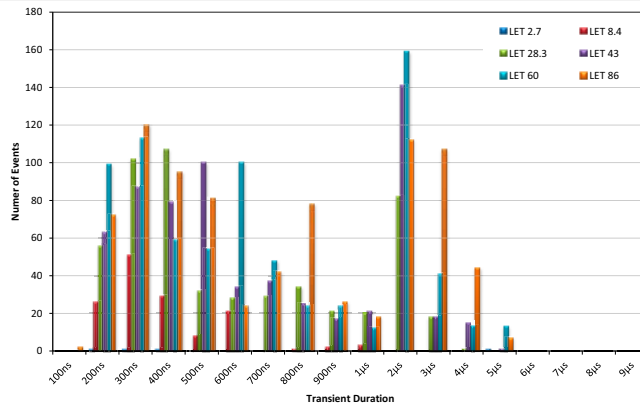

FIGURE 27. MAX TRANSIENT DURATION CAUSED BY SETs ($V_S = \pm 1.35V$, $ACL = 10$), FLUENCE WAS RUN AT $2 \times 10^6/cm^2$

SET Composite Plots (Gain = 10)

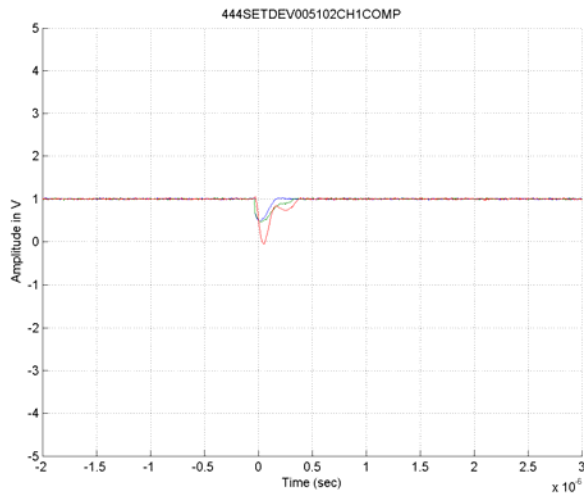

FIGURE 28. LET = $2.7MeV \cdot cm^2/mg$ ($V_S = \pm 1.35V$); FLUENCE WAS RUN AT $2 \times 10^6/cm^2$

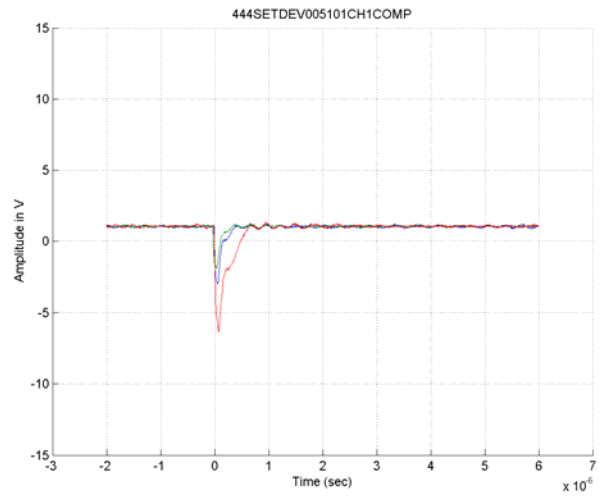

FIGURE 29. LET = $2.7MeV \cdot cm^2/mg$ ($V_S = \pm 15V$); FLUENCE WAS RUN AT $2 \times 10^6/cm^2$

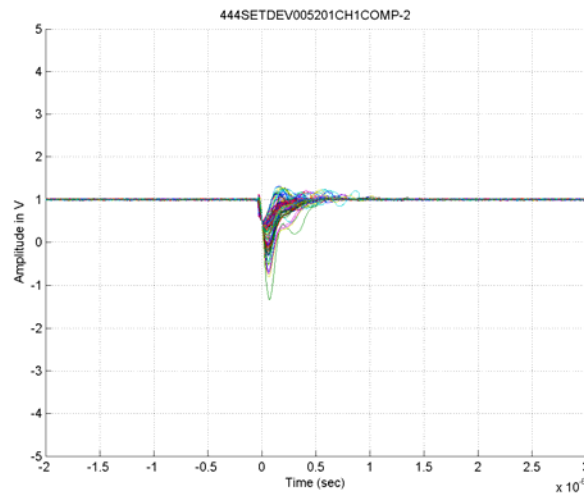

FIGURE 30. LET = $8.4MeV \cdot cm^2/mg$ ($V_S = \pm 1.35V$); FLUENCE WAS RUN AT $2 \times 10^6/cm^2$

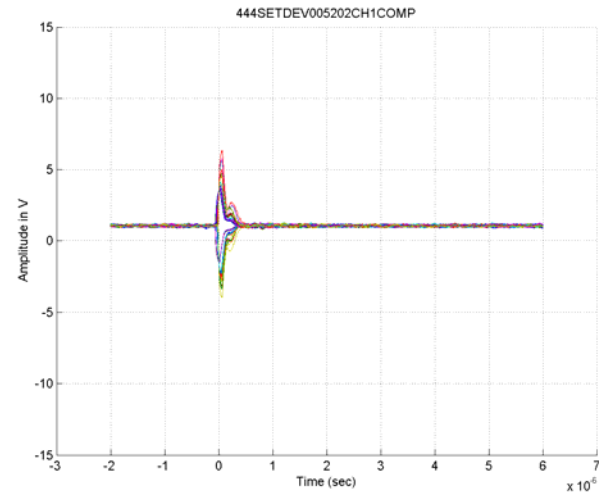

FIGURE 31. LET = $8.4MeV \cdot cm^2/mg$ ($V_S = \pm 15V$); FLUENCE WAS RUN AT $2 \times 10^6/cm^2$

SET Composite Plots (Gain = 10) (Continued)

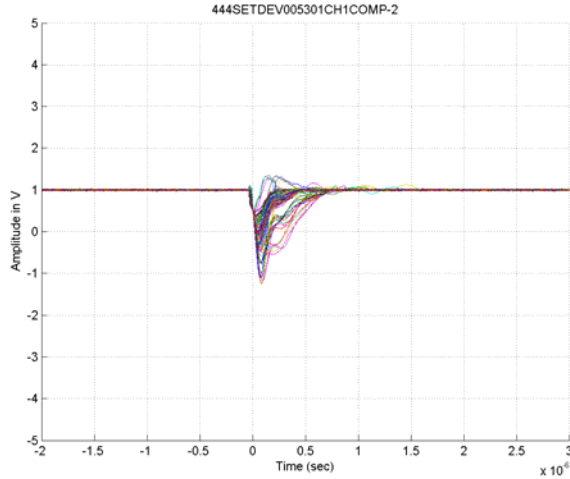

FIGURE 32. LET = 28.3MeV • cm²/mg (V_S = ±1.35V); FLUENCE WAS RUN AT 2x10⁶/cm²

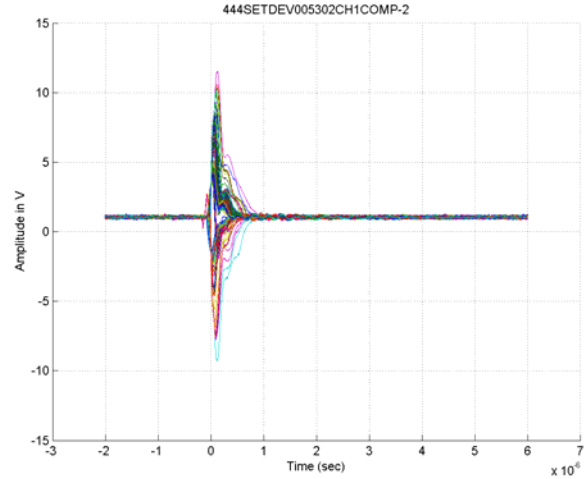

FIGURE 33. LET = 28.3MeV • cm²/mg (V_S = ±15V); FLUENCE WAS RUN AT 2x10⁶/cm²

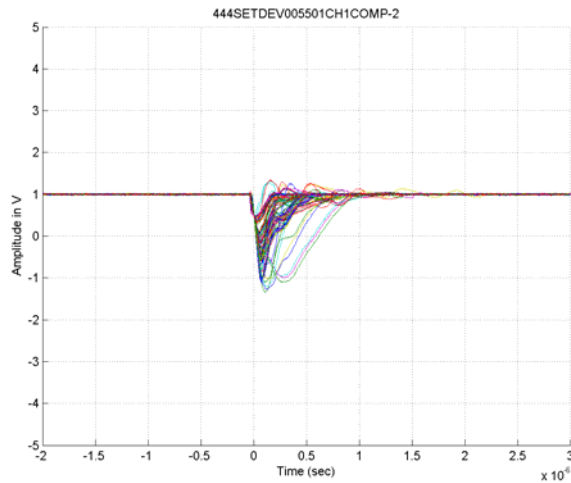

FIGURE 34. LET = 43MeV • cm²/mg (V_S = ±1.35V); FLUENCE WAS RUN AT 2x10⁶/cm²

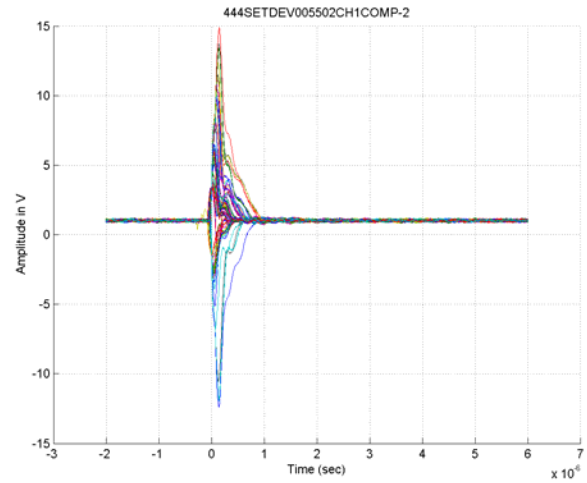

FIGURE 35. LET = 43MeV • cm²/mg (V_S = ±15V); FLUENCE WAS RUN AT 2x10⁶/cm²

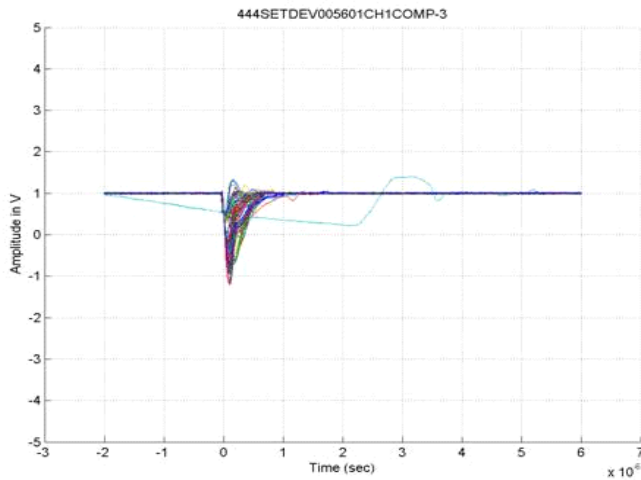

FIGURE 36. LET = 60MeV • cm²/mg (V_S = ±1.35V); FLUENCE WAS RUN AT 2x10⁶/cm²

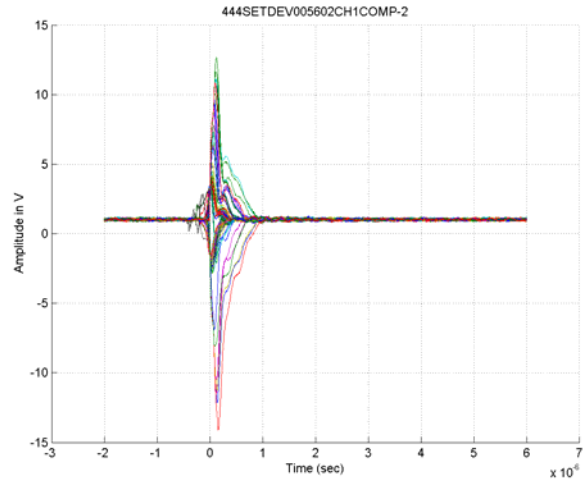

FIGURE 37. LET = 60MeV • cm²/mg (V_S = ±15V); FLUENCE WAS RUN AT 2x10⁶/cm²

SET Composite Plots (Gain = 10) (Continued)

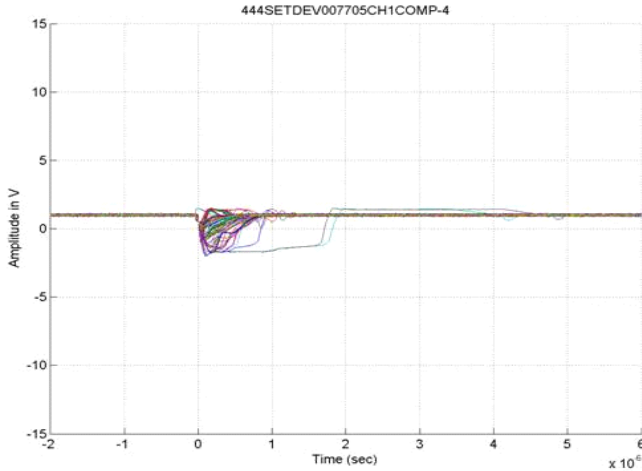

FIGURE 38. LET = 86MeV • cm²/mg (V_S = ±1.35V); FLUENCE WAS RUN AT 2x10⁶/cm²

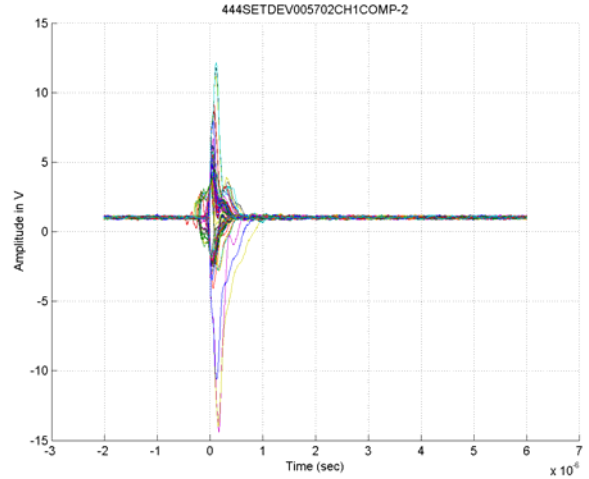

FIGURE 39. LET = 86MeV • cm²/mg (V_S = ±15V); FLUENCE WAS RUN AT 2x10⁶/cm²

Revision History

The revision history provided is for informational purposes only and is believed to be accurate, but not warranted. Please visit our website to make sure you have the latest revision.

| DATE | REVISION | CHANGE |
|--------------|----------|---|
| Jun 22, 2017 | AN1838.1 | Applied new header/footer. Added Revision History at this rev. Updated supply voltage in Table 2 from ±1.5V to ±1.35V for all rows. |

© Copyright Intersil Americas LLC 2013-2017. All Rights Reserved.
All trademarks and registered trademarks are the property of their respective owners.

Intersil Corporation reserves the right to make changes in circuit design, software and/or specifications at any time without notice. Accordingly, the reader is cautioned to verify that the document is current before proceeding.

For information regarding Intersil Corporation and its products, see www.intersil.com

Appendix A

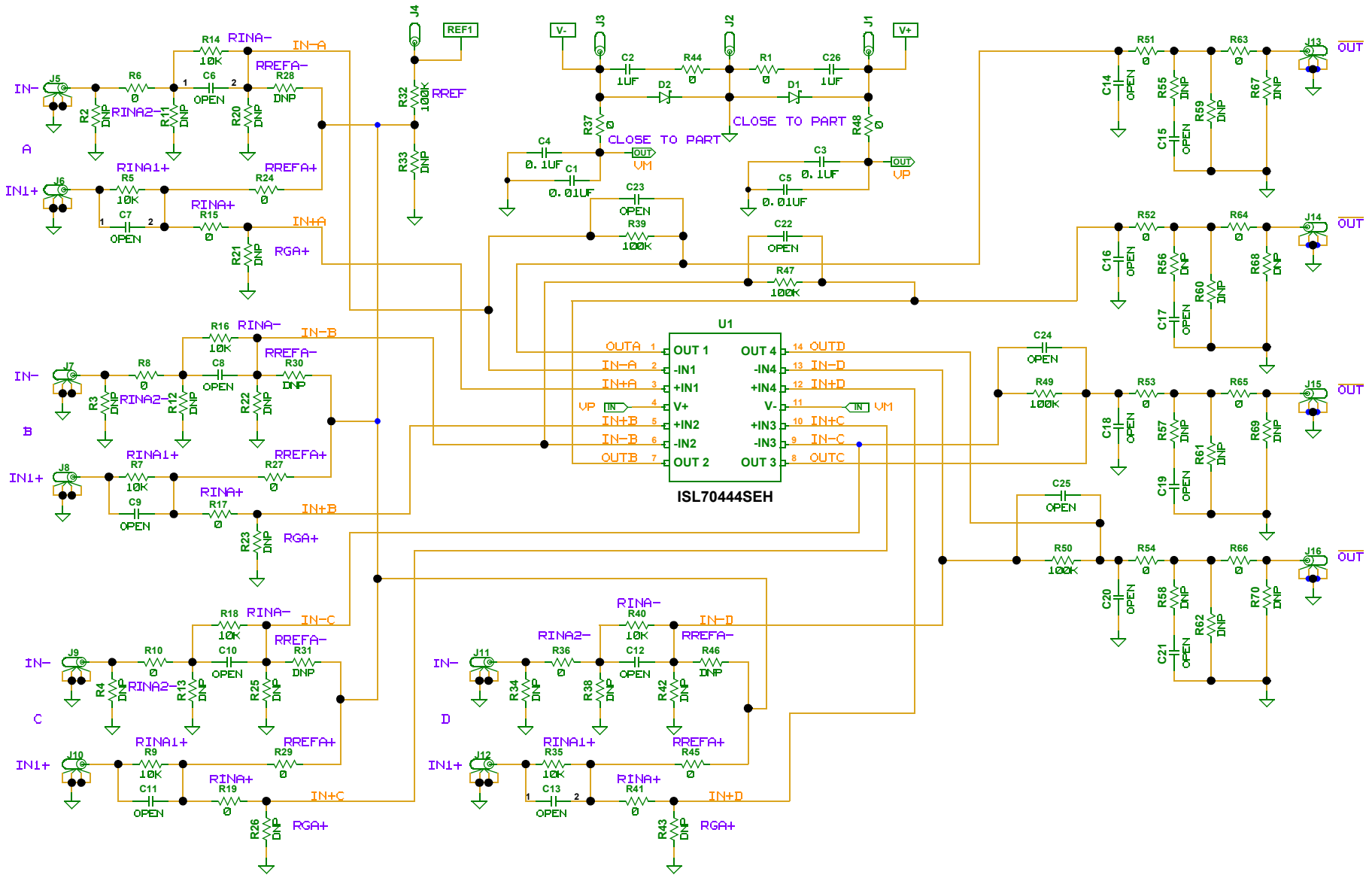

FIGURE 40. SCHEMATIC

ISL70444SEHEVAL1Z Layout

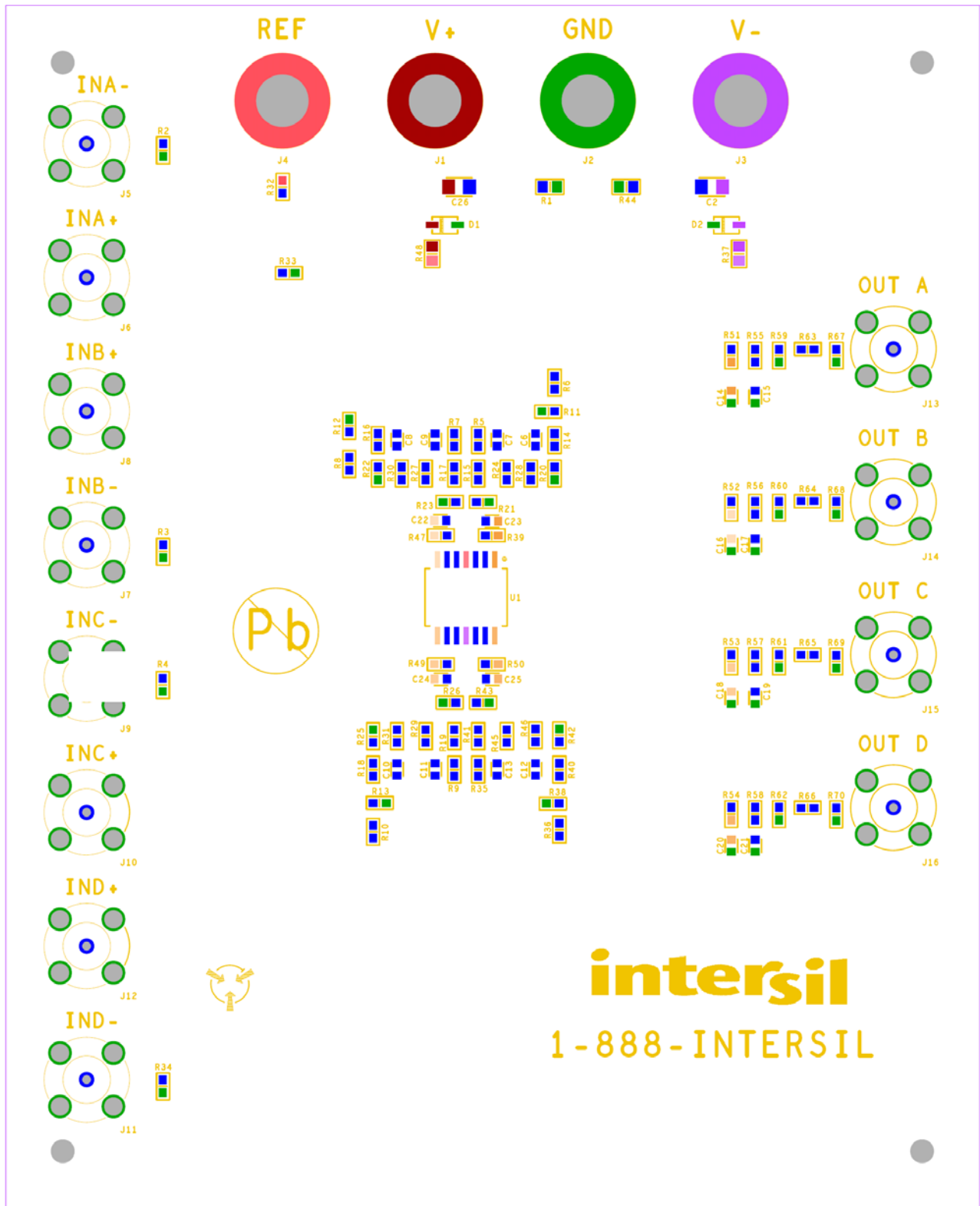

FIGURE 41. TOP VIEW

ISL70444SEHEVAL1Z Layout (Continued)

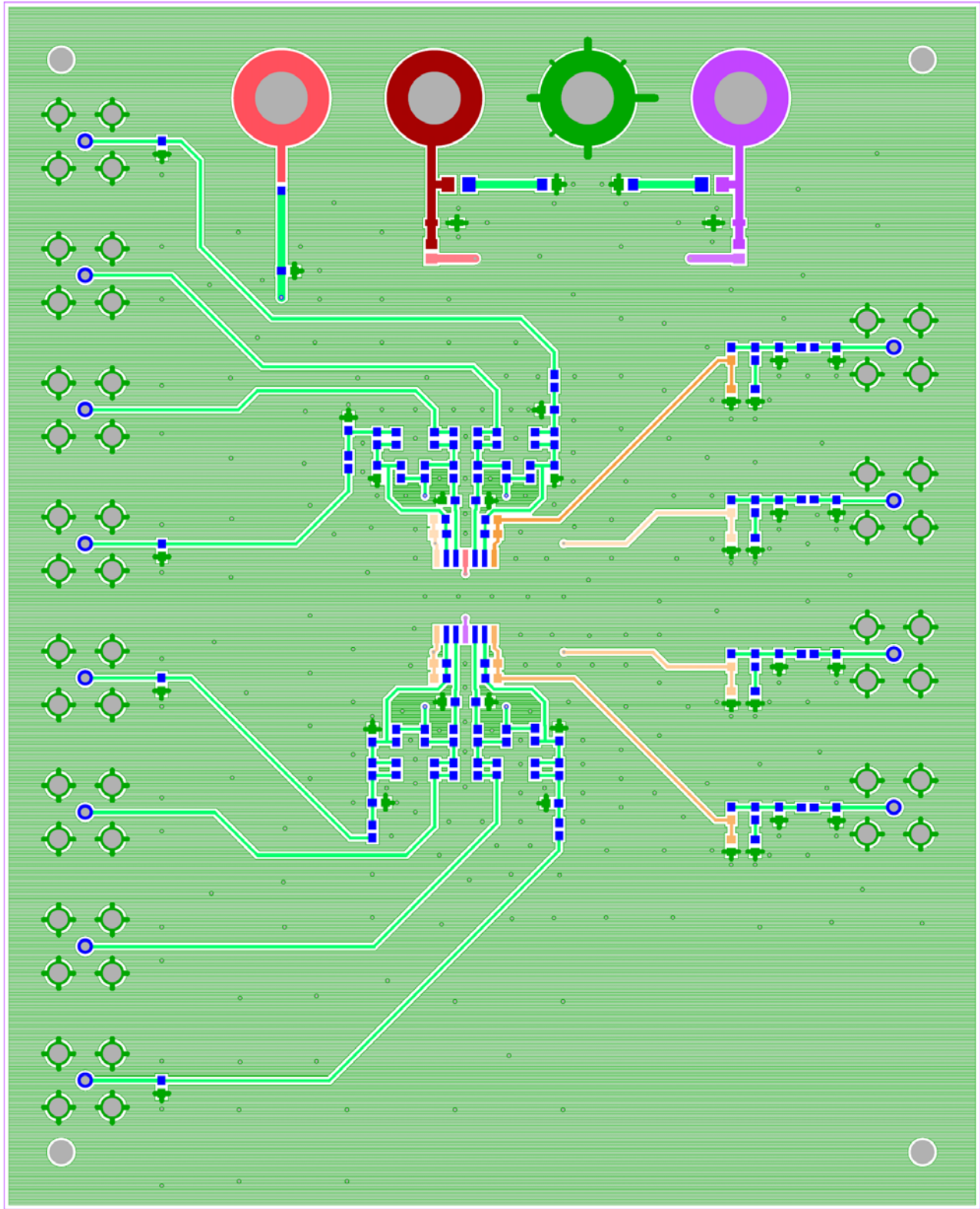

FIGURE 42. TOP LAYER

ISL70444SEHEVAL1Z Layout (Continued)

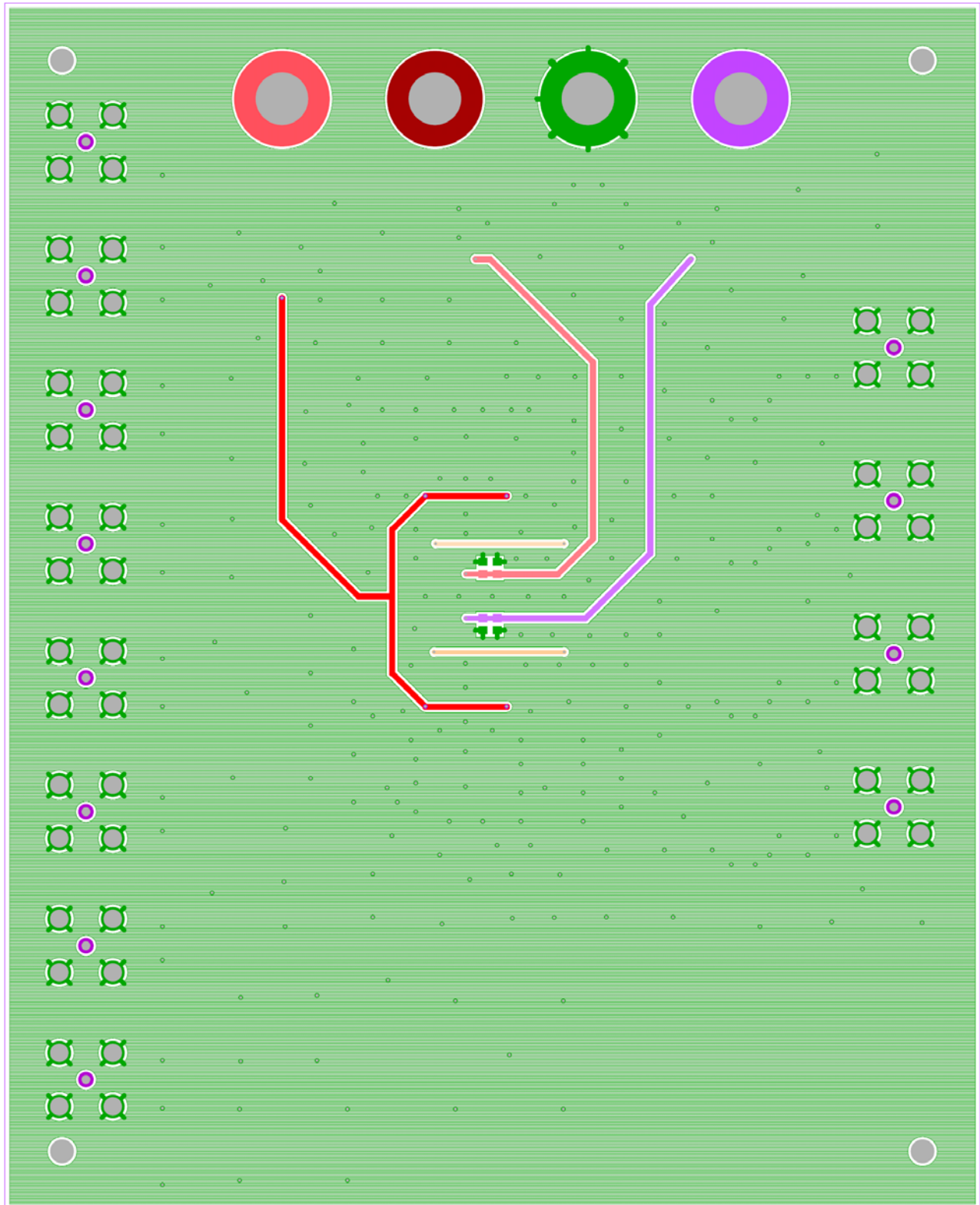

FIGURE 43. BOTTOM LAYER