

HXT45411-4

4 × 112Gbps Linear EML Driver

The HXT45411-4 is a quad-channel linear EML driver array, which is a member of Renesas’ family of Optical Receiver Transmitter Array (ORTA) products. Combining the HXT45411-4 driver with an EML array or a group of discrete EMLs enables designs for compact linear transmitters for the next generation of 400G/800G optical transceivers.

The HXT45411-4 is a low-power, high-performance, quad-channel linear driver, designed for 4x112Gbps PAM4 EML-based transceivers. The HXT45411-4 is a small form-factor (SFF) packaged surface mount device (SMD) with differential inputs and single-ended outputs consisting of 4x56Gbaud broadband amplifier channels, each capable of driving a linear output voltage of 2.0V_{PP}, suitable for 4λ 400G PAM-4 applications.

Block Diagram

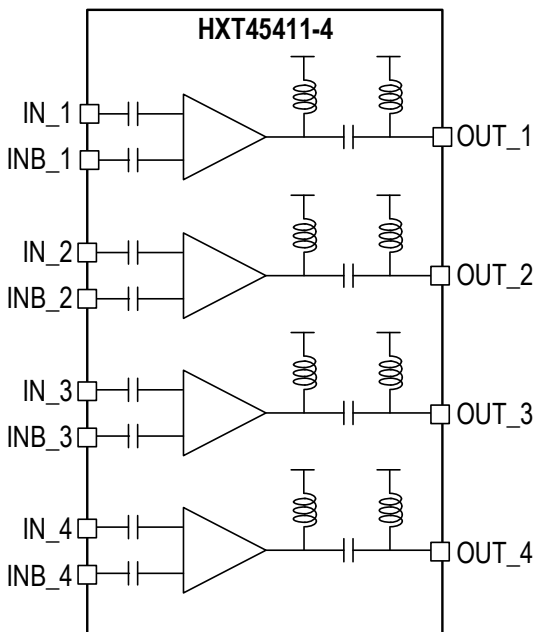

Features

- Data rate up to 56Gbaud per channel for PAM-4 applications
- Low power consumption of 200mW per channel
- > 45GHz bandwidth
- Built-in Bias-T and internal high-frequency chokes
- > 10dB dynamic range of gain control
- Peaking on/off control
- Low channel cross-talk
- Small form-factor SMD
- Internally DC-blocked RF inputs and outputs

Applications

- 400GBASE-DR4, FR4 and LR4 transmitters
- Ethernet optical receiver modules: 200G/400G QSFP-DD or OSFP DR4, FR4 and LR4; and 400G OBO

IMPORTANT NOTICE AND DISCLAIMER

RENESAS ELECTRONICS CORPORATION AND ITS SUBSIDIARIES (“RENESAS”) PROVIDES TECHNICAL SPECIFICATIONS AND RELIABILITY DATA (INCLUDING DATASHEETS), DESIGN RESOURCES (INCLUDING REFERENCE DESIGNS), APPLICATION OR OTHER DESIGN ADVICE, WEB TOOLS, SAFETY INFORMATION, AND OTHER RESOURCES “AS IS” AND WITH ALL FAULTS, AND DISCLAIMS ALL WARRANTIES, EXPRESS OR IMPLIED, INCLUDING, WITHOUT LIMITATION, ANY IMPLIED WARRANTIES OF MERCHANTABILITY, FITNESS FOR A PARTICULAR PURPOSE, OR NON-INFRINGEMENT OF THIRD-PARTY INTELLECTUAL PROPERTY RIGHTS.

These resources are intended for developers who are designing with Renesas products. You are solely responsible for (1) selecting the appropriate products for your application, (2) designing, validating, and testing your application, and (3) ensuring your application meets applicable standards, and any other safety, security, or other requirements. These resources are subject to change without notice. Renesas grants you permission to use these resources only to develop an application that uses Renesas products. Other reproduction or use of these resources is strictly prohibited. No license is granted to any other Renesas intellectual property or to any third-party intellectual property. Renesas disclaims responsibility for, and you will fully indemnify Renesas and its representatives against, any claims, damages, costs, losses, or liabilities arising from your use of these resources. Renesas' products are provided only subject to Renesas' Terms and Conditions of Sale or other applicable terms agreed to in writing. No use of any Renesas resources expands or otherwise alters any applicable warranties or warranty disclaimers for these products.

(Disclaimer Rev.1.01 Jan 2024)

Corporate Headquarters

TOYOSU FORESIA, 3-2-24 Toyosu,
Koto-ku, Tokyo 135-0061, Japan
www.renesas.com

Trademarks

Renesas and the Renesas logo are trademarks of Renesas Electronics Corporation. All trademarks and registered trademarks are the property of their respective owners.

Contact Information

For further information on a product, technology, the most up-to-date version of a document, or your nearest sales office, please visit www.renesas.com/contact-us/.