

To our customers,

Old Company Name in Catalogs and Other Documents

On April 1st, 2010, NEC Electronics Corporation merged with Renesas Technology Corporation, and Renesas Electronics Corporation took over all the business of both companies. Therefore, although the old company name remains in this document, it is a valid Renesas Electronics document. We appreciate your understanding.

Renesas Electronics website: <http://www.renesas.com>

April 1st, 2010
Renesas Electronics Corporation

Issued by: Renesas Electronics Corporation (<http://www.renesas.com>)

Send any inquiries to <http://www.renesas.com/inquiry>.

RENESAS TECHNICAL UPDATE

Nippon Bldg., 2-6-2, Ohte-machi, Chiyoda-ku, Tokyo 100-0004, Japan
Renesas Technology Corp.

Product Category	Transistors		Document No.	TN-PTR-A001A/E	Rev.	1.00
Title	PCN of Marking for Power Transistors		Information Category	Change of Packages		
Applicable Product	All of TO-3P,TO-3PFM,TO-220AB, TO-220FM,TO-220CFM,LDPAK, DPAK,LFPAK,LFPAK-i,WPAK and TSSOP-8	Lot No.	Reference Document			
		All				

Renesas Technology will change the marking of TO-3P,TO-3PFM,TO-220AB, TO-220FM,TO-220CFM, LDPAK, DPAK,LFPAK,LFPAK-I,WPAK and TSSOP-8.

Except Automotive specification. New marking is already applied to Automotive parts.

1. Applicability

TO-3P,TO-3PFM,TO-220AB, TO-220FM,TO-220CFM,LDPAK, DPAK,LFPAK,LFPAK-I,WPAK and TSSOP-8 packaged transistor.

2. Purpose

Improvement of tracability

3. Schedule

Production by new specification will strat from 2008/Apr.

New and old specification may be shipped in disorder by condition of stock.

4. Characteristics

There are no change for maximum ratings, characteristics, reliability, outline or etc.

5. Cahanging of Marking and Applied Products

5.1. Cahanging of Marking for TO-3P and TO-3PFM

[Example for TO-3P(Note:The marking for TO-3PFM is same layout.)]

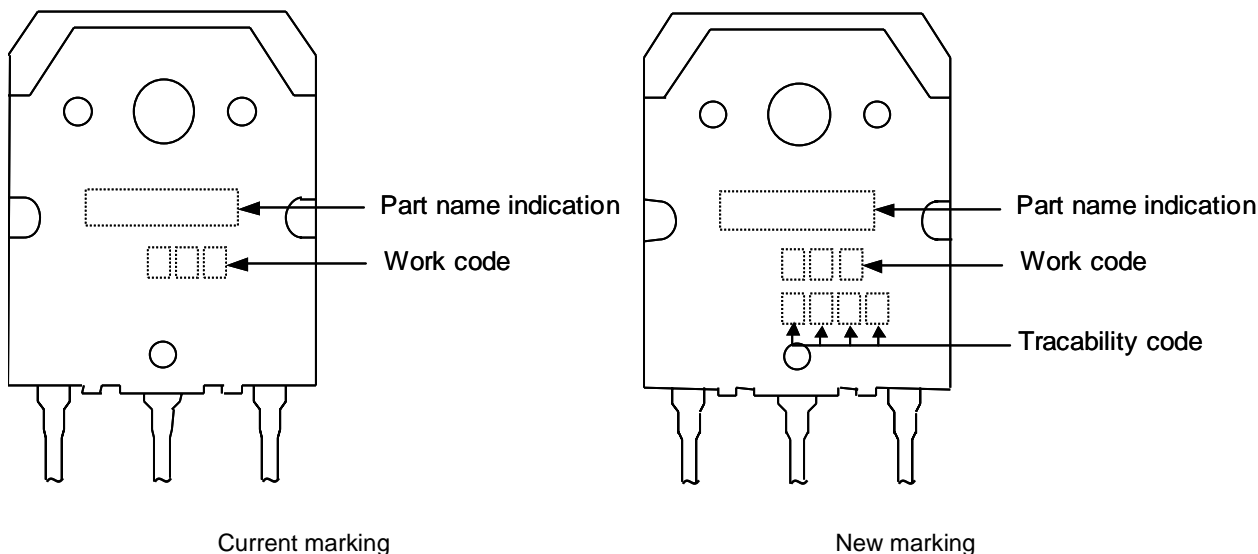

5.2. Applied Products for TO-3P

TO-3P packaged transistor including special specification or custom parts that are not written on follow will be applied.

- 2SB1032K,2SB1079,2SC3336,2SC3365,2SD1436K,2SD1559,2SD2256
- 2SJ160,2SJ161,2SJ162,2SJ215,2SJ217,2SJ351,2SJ352,2SJ554,2SJ555, 2SK1056,2SK1057,2SK1058, 2SK1161,
- 2SK1162,2SK1165,2SK1166,2SK1166,2SK1167,2SK1168, 2SK1169,2SK1170, 2SK1298,2SK1303,2SK1304,2SK1317,
- 2SK1339,2SK1340,2SK1341,2SK1342,2SK1401A,2SK1403A,2SK1515,2SK1516, 2SK1517,2SK1518,2SK1573,2SK1669,
- 2SK1671,2SK1773,2SK1835,2SK1933,2SK1934,2SK1968,2SK2007,2SK2220,2SK2221,2SK2554,2SK2568,2SK2586,
- 2SK2727,2SK2728,2SK2729,2SK2730,2SK2955,2SK3151, 2SK3159,2SK3163, 2SK3235,2SK3419
- H5N1503P,H5N1506P,H5N2003P,H5N2008P,H5N2305P,H5N2501P,H5N2503P,H5N2507P,H5N2509P,H5N2514P,
- H5N2515P,H5N2519P,H5N2801P,H5N2802P,H5N2803P,H5N3003P,H5N3004P,H5N3008P,H5N3011P,H5N5007P,
- H5N5015P,H5N6001P
- RJK1529DPK,RJK2009DPK,RJK2508DPK,RJK2511DPK,RJK2916DPK,RJK3008DPK,RJK3016DPK,RJK4018DPK,
- RJK4514DPK,RJK4515DPK,RJK4518DPK,RJK5010DPK,RJK5013DPK,RJK5014DPK, RJK5015DPK,RJK5018DPK,
- RJK5020DPK,RJK6014DPK,RJK6015DPK,RJK6018DPK,RJK6020DPK
- GN6060V5DP,GN6065V5DP
- RJH6007DPK,RJP2557DPK,RJP3057DPK,RJP3067DPK,RJP4067DPK,RJP6006DPK,RJP6085DPK

5.3. Applied Products for TO-3PFM

TO-3PFM packaged transistor including special specification or custom parts that are not written on follow will be applied.

- 2SC5480
- 2SJ216,2SJ218, 2SK1328,2SK1329,2SK1405,2SK1670,2SK1775,2SK1832,2SK1859,2SK2008,2SK2225
- H5N2301PF,H5N2305PF,H5N2306PF,H5N2509PF,H5N2803PF,RJK2009DPM,RJH6075DPM

5.4. Changing of Marking for TO-220AB and LDKPAK

[Example for TO-220AB(Note:The marking for LDKPAK is same layout.)]

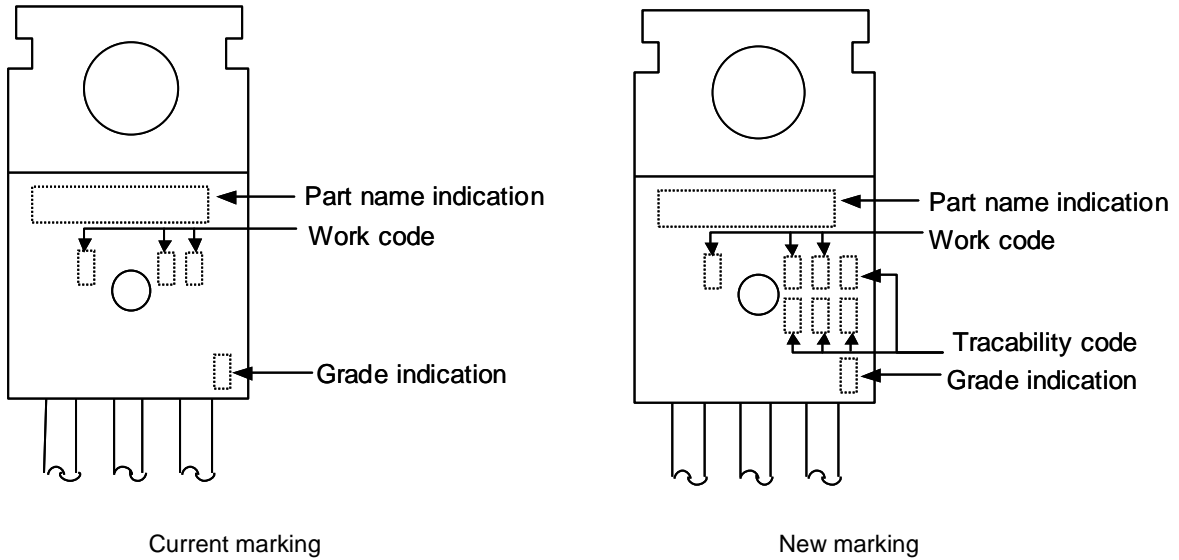

5.5. Applied Products for TO-220AB

TO-220AB packaged transistor including special specification or custom parts that are not written on follow will be applied.

- 2SB566K,2SB566AK,2SB727K,2SB765K,2SB791K,2SB857,2SB858,2SB859,2SB860,2SB861, 2SB955K,2SB1091,
- 2SB1103,2SC1881K,2SC2612,2SC2613,2SC2816,2SC2979,2SC4913,2SD476K, 2SD476AK,2SD768K,2SD864K,
- 2SD970K,2SD1113K,2SD1126K,2SD1133,2SD1134,2SD1135, 2SD1137,2SD1138,2SD1163A,2SD1527
- 2SJ76,2SJ77,2SJ78,2SJ79,2SJ117,2SJ172,2SJ173,2SJ174,2SJ221,2SJ247,2SJ292,2SJ539, 2SJ540,2SJ541,2SJ542,
- 2SJ543,2SJ544, 2SK213,2SK214,2SK215,2SK216,2SK970,2SK971,2SK972, ,2SK1153,2SK1154,2SK1155, 2SK1156,
- 2SK1157,2SK1158,2SK1159,2SK1160,2SK1302,2SK1338,2SK1400A,2SK1402A,2SK1627, 2SK1667,2SK1761,2SK1807,
- 2SK2328,2SK2408,2SK2800,2SK2927,2SK2928,2SK2929,2SK2930, 2SK2931,2SK2959,2SK3069,2SK3136,2SK3141,
- 2SK3149,2SK3154,2SK3156,2SK3158,2SK3228, 2SK3418,2SK3736
- H7N0203AB,H7N0307AB,H7N0308AB,H7N0312AB, H7N0602AB, H7N0603AB,H7N0608AB,H7N1002AB,H7N1004AB,
- H8N0801AB,HS76654,HS76655
- GN6030V4AB,RJP3054DPN,RJP3064DPN,RJP3065DPN,RJP6065DPN

5.6. Applied Products for LDKPAK

LDKPAK packaged transistor including special specification or custom parts that are not written on follow will be applied.

- 2SJ214L/S,2SJ220L/S,2SJ280L/S,2SJ296L/S,2SJ297L/S,2SJ409L/S,2SJ479L/S,2SJ505L/S, 2SJ549L/S,2SJ550L/S,
- 2SJ551L/S,2SJ552L/S,2SJ553L/S, 2SK1313L/S,2SK1314L/S,2SK1315L/S,2SK1316L/S,2SK1528L/S, 2SK1620L/S,
- 2SK1623L/S, 2SK1636L/S,2SK1647L/S,2SK2553L/S,2SK2684L/S,2SK2912L/S,2SK2938L/S,2SK2939L/S, 2SK2940L/S,
- 2SK2957L/S,2SK2958L/S,2SK3070L/S,2SK3082L/S,2SK3134L/S,2SK3135L/S,2SK3150L/S,2SK3161L/S,2SK3210L/S,
- 2SK3211L/S
- H5N2001LS, H5N2007LS, H5N2307LS,H5N2901LS,H5N3007LS,H5N3301LS H7N0307LD/LS,H7N0308LD/LS,
- H7N0307LD/LS,H7N0308LD/LS,H7N0310LD/LS,H7N0311LD/LS,H7N0312LD/LS,H7N0602LD/LS/LM, H7N0606LD/LS,
- H7N1002LD/LS/LM,H7N1004LD/LS,H7N1005LD/LS,H8N0603LD
- RJK1525DPJ/DPE/DPF,RJK1526DPE/DPF,RJK1535DPE,RJK2017DPE,RJK4013DPE,RJK4514APE, RJK6012DPE,
- RJK6026DPE
- GN6020V4LS,GN6030V4LS,RJP6003DPE

5.7. Changing of Marking for TO-220FM and TO-220CFM

[Example for TO-220FM(Note:The marking for TO-220CFM is same layout.)]

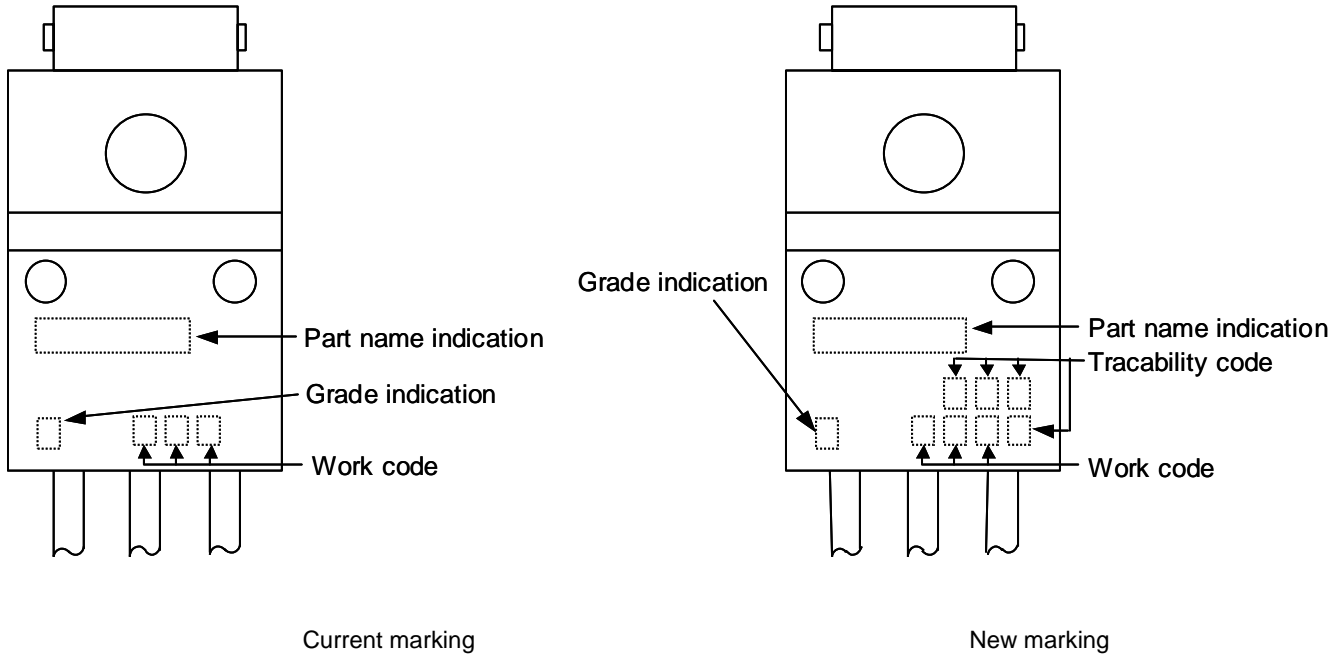

5.8. Applied Products for TO-220FM

TO-220FM packaged transistor including special specification or custom parts that are not written on follow will be applied.

2SB1262,2SB1389,2SB1390,2SB1391,2SB1392,2SB1399,2SB1400,2SB1530,2SC5022,2SD1900, 2SD2101,2SD2106, 2SD2337

2SJ175,2SJ176,2SJ177,2SJ222,2SJ248,2SJ293,2SJ294,2SJ295,2SJ350,2SJ504,2SJ526, 2SJ534,2SJ535,2SJ547,

2SJ548, 2SK1093,2SK1094,2SK1095,2SK1305,2SK1306,2SK1307,2SK1318,2SK1404,2SK1566,2SK1567, 2SK1572,

2SK1626, 2SK1637,2SK1668,2SK1762,2SK1808,2SK1957,2SK2202,2SK2937,2SK3148, 2SK3152,2SK3155,2SK3157,

2SK3160,2SK3162,2SK3177,2SK3209,2SK3212,2SK3308

H5N5001FM,H5N5006FM,H7N0608FM,H7N1004FM,H7N1005FM

5.9. Applied Products for TO-220CFM

TO-220CFM packaged transistor including special specification or custom parts that are not written on follow will be applied.

2SJ471,2SJ532,2SJ533,2SJ545,2SJ546, 2SK2114,2SK2424,2SK2425,2SK2529,2SK2725,2SK2726, 2SK2736, 2SK2737,

2SK2738,2SK2932, 2SK2933,2SK2934,2SK2935,2SK2936,2SK2956,2SK3140,2SK3142,2SK3229, ,2SK3233,2SK3234,

H5N2502CF,H5N2512CF,H5N3007CF,H7N0308CF,RJK1525DPS

GN6030V5CF,RJP3063DPP, RJP4065DPP

5.10. Cahanging of Marking for DPAK

[Example for DPAK]

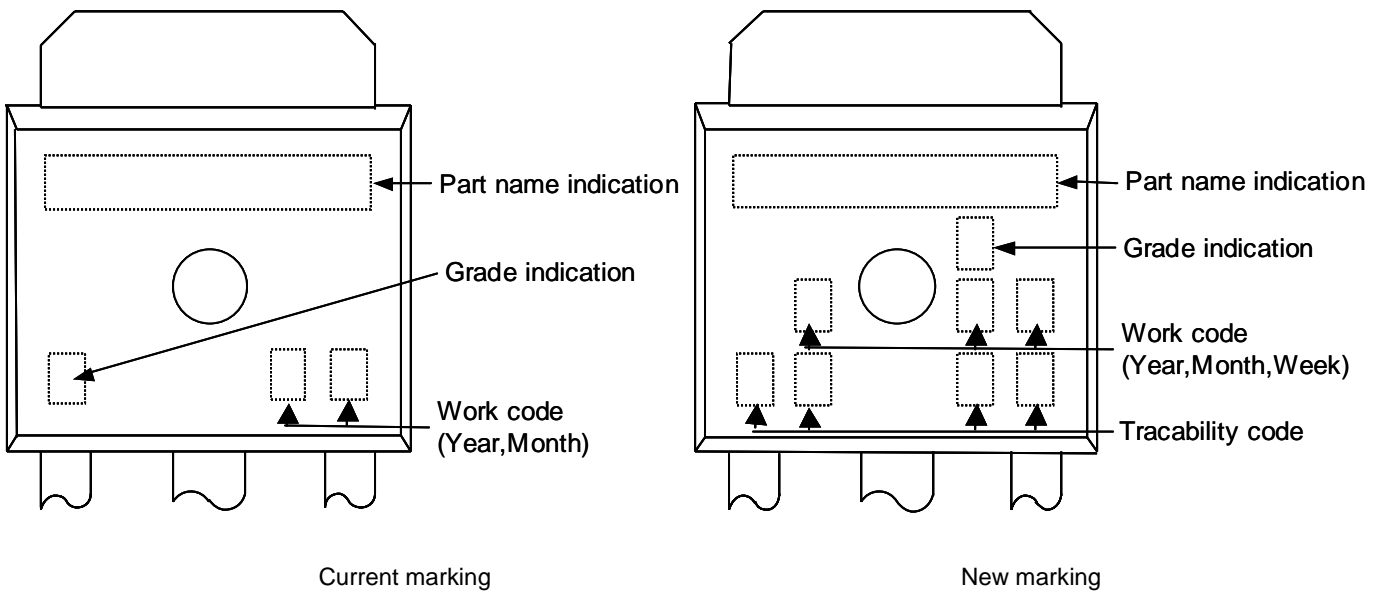

5.11. Applied Products for DPAK

DPAK packaged transistor including special specification or custom parts that are not written on follow will be applied.

- 2SB1072L/S,2SB1407L/S,2SB1661S,2SB1681S,2SC4500L/S,2SD2115L/S, 2SD2123L/S, 2SD2124L/S,2SD2592S, 2SD2632S
- 2SJ130L/S,2SJ181L/S,2SJ182L/S,2SJ234L/S,2SJ245L/S,2SJ246L/S,2SJ279L/S,2SJ318L/S, 2SJ319L/S,2SJ332L/S, 2SJ387L/S,2SJ389L/S,2SJ506L/S,2SJ527L/S,2SJ528L/S,2SJ529L/S,2SJ530L/S,2SK973L/S,2SK974L/S,2SK1151L/S, 2SK1152L/S,2SK1254L/S,2SK1299L/S,2SK1335L/S, 2SK1838L/S,2SK1880L/S, 2SK1949L/S,2SK2059L/S,2SK2084L/S, 2SK2329L/S,2SK2735L/S,2SK2796L/S,2SK2869L/S,2SK2925L/S,2SK2926L/S,2SK3147L/S,2SK3274L/S
- H5N2004DL/DS,H5N2005DL/DS,H5N2504DL/DS,H5N2505DL/DS,H5N2508DL/DS,H5N2510DL/DS, H5N5006DL/DS, H7N0603DL/DS,H7N0607DL/DS,H7N1004DL/DS,H7N1005DL/DS,H7P0601DL/DS,H7N1002DL/DS

5.12. Cahanging of Marking for LFPAK and LFPAK-i

[Example for LFPAK(Note:The marking for LFPAK-i is same layout.)]

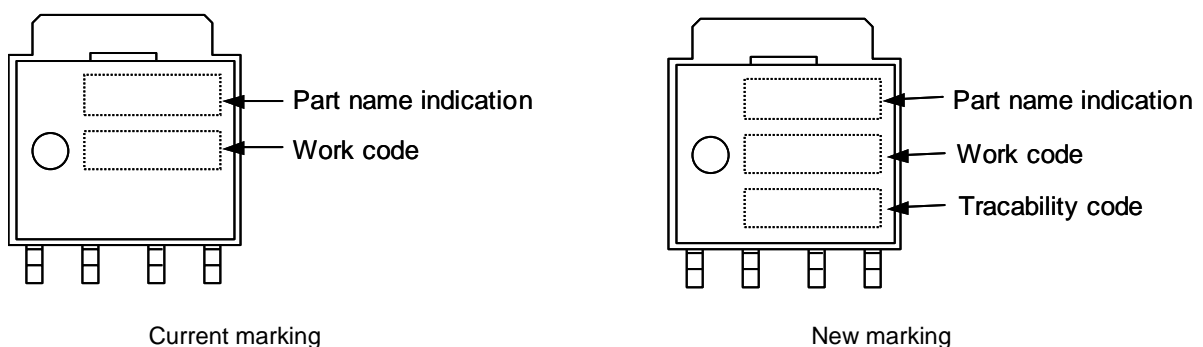

5.13. Applied Products for LFPAK

LFPAK packaged transistor including special specification or custom parts that are not written on follow will be applied.
 HAT1072H,HAT1125H,HAT1127H,HAT1139H,HAT2096H,HAT2099H,HAT2116H,HAT2129H,HAT2134H, HAT2137H,
 HAT2139H,HAT2140H,HAT2141H,HAT2142H,HAT2143H,HAT2160H,HAT2164H,HAT2165H, HAT2166H,HAT2167H,
 HAT2168H,HAT2169H,HAT2170H,HAT2171H,HAT2172H,HAT2173H,HAT2174H, HAT2175H,HAT2261H,HAT2265H,
 HAT2266H,HAT2267H,HAT2270H,HAT2279H
 RJK0301DPB,RJK0302DPB,RJK0303DPB,RJK0304DPB,RJK0305DPB,RJK0328DPB,RJK0329DPB, RJK0330DPB,
 RJK0331DPB,RJK0332DPB,RJK0372DPB

5.14. Applied Products for LFPAK-i

LFPAK –i packaged transistor including special specification or custom parts that are not written on follow will be applied.
 HAT2160N,HAT2164N,HAT2165N,HAT2166N,HAT2167N,HAT2168N,HAT2169N,HAT2170N,HAT2171N, HAT2172N,
 HAT2173N,HAT2174N,HAT2175N,HAT2261N,HAT2265N,HAT2266N,HAT2279N
 RJK0301DPC,RJK0302DPC,RJK0303DPC,RJK0304DPC,RJK0305DPC

5.15. Cahanging of Marking for WPAK

[Example for WPAK]

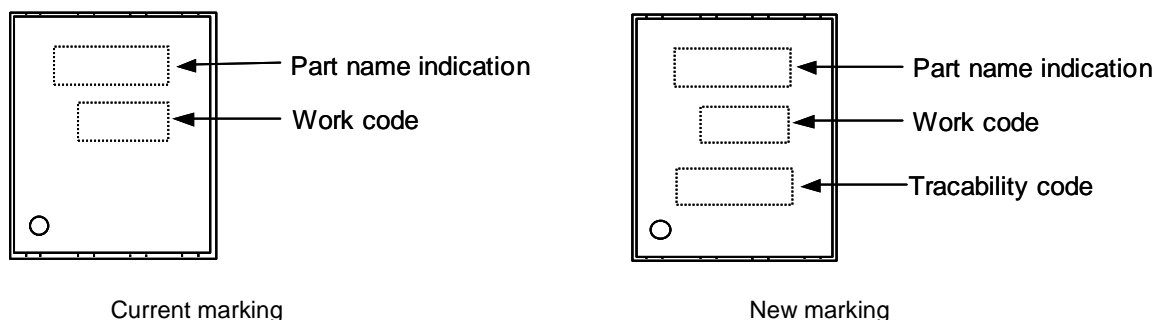

5.16. Applied Products for WPAK

WPAK packaged transistor including special specification or custom parts that are not written on follow will be applied.
 HAT1101WP,HAT1107WP,HAT2087WP,HAT2089WP,HAT2183WP,HAT2184WP,HAT2185WP,HAT2187WP, HAT2188WP,
 HAT2189WP,HAT2191WP,HAT2191WP,HAT2192WP,HAT2193WP,HAT2195WP,HAT2197WP, HAT2198WP,HAT2199WP,
 HAT2200WP,HAT2201WP,HAT2209WP,HAT2210WP,HAT2211WP.HAT2244WP, HAT2285WP,HAT2287WP,HAT2299WP
 RJK0316DPA,RJK0317DPA,RJK0346DPA,RJK0347DPA,RJK0348DPA,RJK0349DPA,RJK0350DPA, RJK0351DPA,
 RJK0353DPA,RJK0355DPA,RJK0356DPA,RJK0358DPA,RJK0359DPA,RJK0360DPA, RJK0364DPA,RJK0365DPA,
 RJK0366DPA,RJK0369DPA

5.15. Changing of Marking for TSSOP-8

[Example for TSSOP-8]

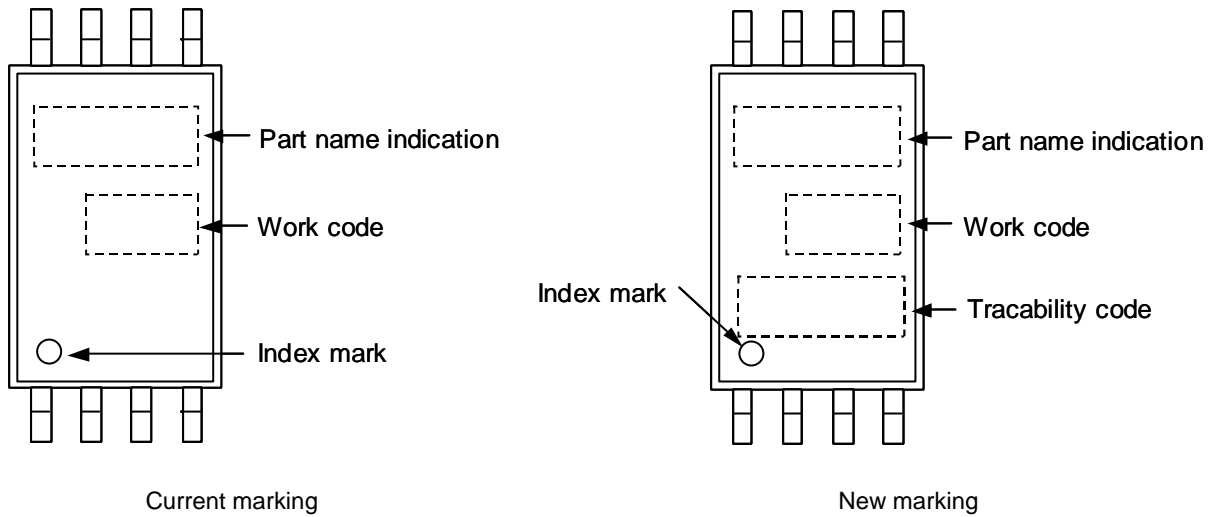

5.16. Applied Products for TSSOP-8

TSSOP-8 packaged transistor including special specification or custom parts that are not written on follow will be applied.
 HAT1033T, HAT1041T, HAT1065T, HAT2050T, HAT2051T, HAT2080T, HAT2085T, HAT2105T, HAT3015T