

**Introduction**

This application note will discuss a method to combine the operation of a boost regulator and a negative voltage converter. The circuit described will generate both a positive and a negative supply from a single low voltage supply. The circuit in Figure 5 shows the standard ISL97701 application circuit for a +20V supply along with two ISL28107 op amps, two diodes and two capacitors to generate a well regulated -20V supply.

**Understanding the Boost Topology**

Before we add the additional circuitry to generate the negative supply, it is important to understand how the boost converter produces an output voltage that is always greater than the input voltage. In order to do this, we analyze the boost circuits in Figure 1 and the current waveforms in Figure 2. For this analysis, we account for all the losses in the charging and discharging loops in our equations. This should help to give a complete understanding of the circuit.

However, the ISL97701's output voltage is not dependent upon any losses in the circuit. This is because all the losses are inside the circuit's feedback loop of the ISL97701, and are automatically accounted for. The output voltage is defined from the feedback resistor network shown in Figure 5 and calculated in Equation 1, where  $V_{refFB}$  is the internal reference voltage of the ISL97701.

$$V_{OUT} = V_{refFB} \cdot (R_1 + R_2) / R_2$$

$$V_{OUT} = 1.15V \cdot (R_1 + R_2) / R_2 \quad (EQ. 1)$$

**Positive Supply**

Figure 1A shows the basic boost converter circuit. During one switching cycle, the transistor  $Q_1$  turns on and turns off. During the time  $Q_1$  is on, the inductor  $L_1$  is placed in series with the  $V_{IN}$  supply through the ISL97701's integrated boost FET ( $Q_1$ ). The diode  $D_1$  is reversed biased and the circuit reduces to that shown in Figure 1B. The voltage across the boost inductor ( $L_1$ ) is equal to  $V_{IN} - (V_{DS} + I_{L1} \times R_{L1})$  and the current ramps up linearly in inductor  $L_1$  to a peak value at time  $DT$ . The peak inductor current ( $\Delta I_{L1(on)}$ ) is calculated in Equation 3 and shown graphically in Figure 1B. Any load requirements during this phase are supplied by the output capacitor  $C_1$ .

$$V_L = L \times \frac{di_L}{dt} \Rightarrow i_{Lpk} = \frac{V_L}{L} \int_{T_0}^{DT} dt \quad (EQ. 2)$$

$$\Delta I_{L1(on)} = \frac{V_{IN} - (V_{DS} + I_{L1} \times R_{L1})}{L} \times DT \quad (EQ. 3)$$

When  $Q_1$  turns off, since the current in an inductor cannot change instantaneously, the voltage in  $L_1$  reverses and the circuit becomes that shown in Figure 1C. Now the no-dot end of  $L_1$  is positive with respect to the dot end and  $D_1$  becomes forward biased. Since the dot end is at  $V_{IN}$ ,  $L_1$  delivers its stored energy to  $C_1$  and charges it up to a higher voltage than

$V_{IN}$ . This energy supplies the load current and replenishes the charge drained away from  $C_1$ . During this time, energy is also supplied to the load from  $V_{IN}$ . The voltage applied to the dot end of the inductor is  $(V_{IN} - I_{L1} \times R_{L1})$ . The voltage applied to the no-dot end of  $L_1$  is now the output voltage,  $V_O$ , plus the diode forward voltage  $V_D$ . The voltage across the inductor during the off-state is  $((V_O + V_{D1} + I_{L1} \times R_{L1}) - V_{IN})$ . The inductor current during the off-time of the switch ( $T-DT$ ) is calculated in Equation 4 and shown graphically in Figure 1C.

$$\Delta I_{L1(off)} = \frac{(V_O + V_{D1} + I_{L1} \times R_{L1}) - V_{IN}}{L} \times (T - DT) \quad (EQ. 4)$$

In steady-state conditions, the current increases during the on-time of the switch and decreases during the off-time of the switch, reference Figure 2. Both on-time and off-time currents are equal to prevent the inductor core from saturating. Setting both currents equal to each other and solving for  $V_O$  results in the continuous conduction mode boost voltage shown in Equation 5.

$$V_O = \frac{V_{IN} - I_L \times R_L}{1 - D} - V_{D1} - V_{DS} \times \frac{D}{1 - D} \quad (EQ. 5)$$

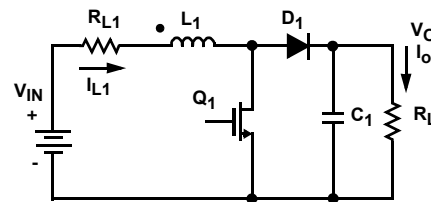

FIGURE 1A.

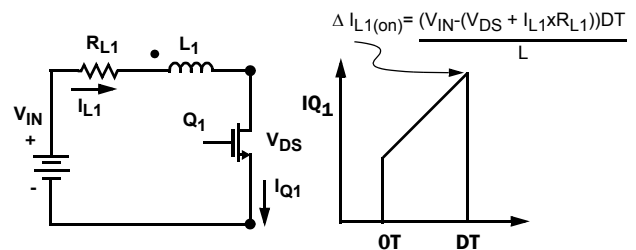

FIGURE 1B.

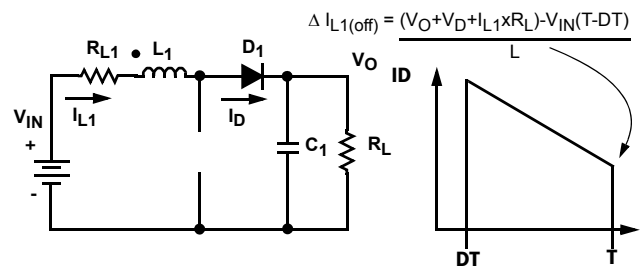

FIGURE 1C.

FIGURE 1. BASIC BOOST TOPOLOGY

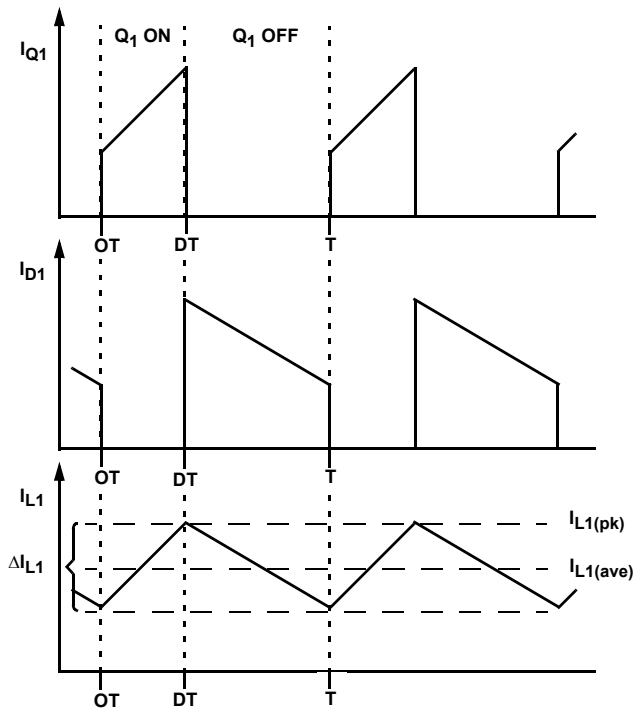

FIGURE 2. INDUCTOR, TRANSISTOR AND DIODE CURRENTS

The duty cycle “D” in Equation 5 is determined by setting the losses in Equation 5 ( $I_{L1} \times R_{L1}$ ,  $V_{D1}$ ,  $V_{DS}$ ) to zero because they are within the feedback loop of the ISL97701. The ISL97701 varies the duty cycle continuously to keep  $V_O$  constant, regardless of the conduction losses as a function of load current. With the losses set to zero, Equation 5 reduces to Equation 6. This results in the value for the Duty Cycle as shown in Equation 7.

$$\frac{V_O}{V_{IN}} = \frac{1}{1-D} \quad (\text{EQ. 6})$$

$$D = 1 - \frac{V_{IN}}{V_O} \quad (\text{EQ. 7})$$

### Inductor Selection

The inductor selection determines the output ripple voltage, transient response, output current capability, and efficiency. Its selection depends on the input voltage, peak inductor current, output voltage, switching frequency, and maximum output current. When choosing an inductor, make sure the saturation current of the inductor is greater than the  $I_{PEAK}$  of the circuit. Likewise, the transistor should be able to handle peak current greater than  $I_{PEAK}$ . The peak inductor current is shown in Figure 3 and can be calculated using Equation 11.

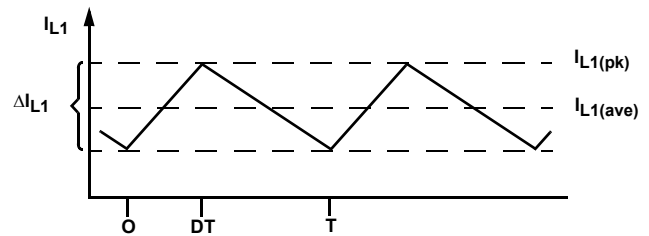

FIGURE 3. INDUCTOR AVERAGE AND PEAK CURRENTS

From Figure 3, it can be seen that the peak inductor current  $I_{L1(PK)}$  is equal to the average inductor current  $I_{L1(ave)}$  plus one half the  $\Delta I_{L1}$  current, as shown in Equation 8.

$$I_{L1(PEAK)} = I_{L1(AVE)} + \frac{1}{2} \Delta I_{L1(on)} \quad (\text{EQ. 8})$$

The average power IN is equal to the average power OUT divided by the efficiency of the circuit, as shown in Equation 9.

$$V_{IN} \times I_{L1(AVE)} = \frac{V_O \times I_O}{\text{Eff}} \quad (\text{EQ. 9})$$

Where Eff is equal to the efficiency of the ISL97701 boost regulator.

Therefore, the average inductor current is equal to the output current times the gain of the boost regulator as shown in Equation 10.

$$I_{L1(AVE)} = \frac{V_O \times I_O}{V_{IN} \times \text{Eff}} \quad (\text{EQ. 10})$$

$\Delta I_{L1(on)}$  was defined in Equation 3 and the duty cycle “D” in Equation 7. Substituting Equation 7 into Equation 3 and adding it to Equation 10 results in Equation 11. Equation 11 gives the inductor’s peak current in terms of input voltage, output voltage, switching frequency, and maximum output current (again, the losses due to  $V_{DS}$  and  $I_{L1} \times R_{L1}$  are not included because they are inside the feedback loop of the ISL97701).

$$I_{L1(PEAK)} = \frac{V_O \times I_O}{V_{IN} \times \text{Eff}} + \frac{1}{2} \times \frac{V_{IN} \times (V_O - V_{IN})}{L \times V_O \times \text{FREQ}} \quad (\text{EQ. 11})$$

By rearranging the terms in Equations 11, we can solve for the inductor value using Equation 12.

$$L = \frac{V_{IN}^2 \text{Eff} (V_O - V_{IN})}{(I_{PK} V_{IN} \text{Eff} - I_O V_O) 2 V_O \text{FREQ}} \quad (\text{EQ. 12})$$

Equation 12 is useful for determining the minimum value of L the circuit can handle without exceeding the peak current through the inductor, and therefore, the switch  $Q_1$ . The maximum peak current ( $I_{PEAK}$ ) allowed through  $Q_1$  for safe operation is given in the Electrical Specification table of the [ISL97701](#) data sheet as 1.2A.

### Minimum Inductor Value Design Example

Given:  $V_{IN} = 5V$ ,  $V_O = 25V$ ,  $I_O = 35mA$ ,  $I_{PK} = 1.2A$ ,  $f_{req} = 1MHz$ ,  $Eff = 0.85$  (Efficiency of 85% from Figure 3 in ISL97701 data sheet).

Equation 12 gives us the boundary condition for the smallest inductor we can have to ensure the peak current through  $Q_1$  is less than the max limit of 1.2A. The minimum inductor value for the given conditions is determined to be 2.0 $\mu$ H.

$$L = \frac{(5V)^2(0.85)(25-5)}{(1.2A(5)(0.85)-35mA(25))^2(2)(25)1MHz} = 2.0\mu H \quad (EQ. 13)$$

### Maintaining CCM Design Example

For maximum efficiency, the boost converter needs to be operated in continuous conduction mode (CCM). To maintain continuous conduction mode operation of the boost regulator, the value of  $I_{L1(ave)}$  needs to be greater than or equal to  $\Delta I_{L1}/2$ , reference Figure 3.

$$I_{L1(AVE)} \geq \frac{1}{2} \Delta I_{L1}$$

$$\frac{V_O \times I_O}{V_{IN} \times Eff} \geq 1/2 \times \frac{V_{IN} \times (V_O - V_{IN})}{L \times V_O \times FREQ} \quad (EQ. 14)$$

Rearranging terms and solving for L results in Equation 15.

$$L \geq 1/2 \times \frac{V_{IN} \times (V_O - V_{IN})}{\frac{V_O \times I_O}{V_{IN} \times Eff} \times V_O \times FREQ} \quad (EQ. 15)$$

To maintain continuous conduction mode operation, for the given circuit design conditions above, the value of L has to be greater than 9.71 $\mu$ H.

$$L \geq 1/2 \times \frac{5V \times (25V - 5V)}{\frac{25V \times 35mA}{5V \times (0.85)} \times 25V \times 1MHz} \geq 9.71\mu H \quad (EQ. 16)$$

It should be noted that when there is a light load, the circuit can slip into discontinuous conduction mode, where the inductor becomes fully discharged of its current each cycle. This operation will reduce the overall efficiency of the supply. Using Equation 15 and making the value of the inductor large enough for a given minimum output current will insure continuous conduction mode operation.

### Output Capacitor

Low ESR capacitors should be used to minimize the output voltage ripple. Multilayer ceramic capacitors (X5R and X7R) are preferred for the output capacitors because of their lower ESR and small packages. Tantalum capacitors with higher ESR can also be used. The output ripple can be calculated in Equation 17:

$$\Delta V_O = \frac{I_{OUT} \times D}{f_{SW} \times C_1} + I_{OUT} \times ESR \quad (EQ. 17)$$

For noise sensitive applications, a 0.1 $\mu$ F placed in parallel with the larger output capacitor is recommended to reduce the switching noise.

### Negative Supply

The operation of the negative supply is best understood by considering Figure 5. We will start our analysis under steady state conditions (the inductor operating in continuous conduction mode and  $C_1$  is equal to the voltage calculated in Equation 1).

When  $Q_1$  turns off, the inductor voltage flies up turning on  $D_1$  and  $D_3$ . Diode  $D_2$  is blocking current flow from  $C_3$ . The inductor current now charges both capacitors  $C_1$  and  $C_2$  with the polarity as shown in Figure 5. The voltage on  $C_2$  is equal to the voltage on  $C_1$ , plus the forward voltage drop of  $D_1$ .

When  $Q_1$  turns on, Diodes  $D_1$  and  $D_3$  are blocking and capacitor  $C_2$  is now in parallel with capacitor  $C_3$  through  $D_2$  (which is now on), reference Figure 4. This connection results in a negative voltage being transferred on to  $C_3$ . The voltage transferred to  $C_3$  is equal to the voltage on  $C_1$  as shown in Figure 4 and Equation 18.

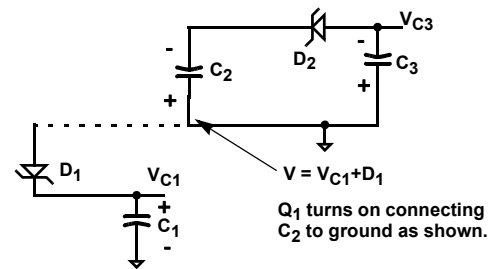

FIGURE 4. CHARGING OF NEGATIVE SUPPLY CAPACITOR  $C_3$

$$(V_{C1} + D_1) - D_2 - V_{C3} = 0$$

$$V_{C1} = V_{C3} \quad (EQ. 18)$$

The efficiency of the charge transfer between the two capacitors is related to the energy lost during this process. **ENERGY IS LOST ONLY IN THE TRANSFER OF CHARGE BETWEEN CAPACITORS IF A CHANGE IN VOLTAGE OCCURS.** The energy lost is defined in Equation 19:

$$E = \frac{1}{2} C_2 (V_1^2 - V_2^2) \quad (EQ. 19)$$

Where  $V_1$  and  $V_2$  are the voltages on  $C_2$  during the charging and transfer cycles. If the impedances of  $C_2$  and  $C_3$  are relatively high at the 1MHz frequency compared to the value of  $R_L$ , there will be substantial difference in the voltages  $V_1$  and  $V_2$ . Therefore, it is not only desirable to make  $C_3$  as large as possible to eliminate output voltage ripple, but also to employ a correspondingly large value for  $C_2$  in order to achieve maximum efficiency of operation.

### Output Voltage Regulation using Op Amps

The final output voltage regulation is accomplished using two ISL28107 op amps (note: two separate op amps required because of the different supply connections). The voltage developed by the boost converter powers the amplifiers and the output voltage is calculated using Equations 20 and 21.

$$V_{OUT(positive)} = 5V \cdot (R_3 + R_4) / R_3 \quad (EQ. 20)$$

$$V_{OUT(negative)} = -V_{OUT(positive)} \cdot R_6 / R_5 \quad (EQ. 21)$$

**Restriction on Design:**

1. For reasonable voltage regulation of the negative supply voltage, the negative supply current needs to be less than or equal to the positive supply current. This is because the control loop for output voltage regulation is around the positive supply voltage only.

$$I_{OUT(positive)} \geq I_{OUT(negative)} \quad (EQ. 22)$$

2. The maximum output current of the circuit shown in Figure 5 is limited by the maximum output current of the ISL28107 op amps, which is 40mA.
3. The ISL97701 is optimized to work best for a small range of inductors. The slope compensation ramp generator, inside the ISL97701, is optimized for inductor values between the range of 4.7µH to 15µH and output currents between 25mA to 125mA. The circuit will work for inductor values outside this range, as long as the maximum  $I_{PEAK}$  current is not

exceeded (Equation 12). The only drawback will be a reduction in the efficiency of the circuit. The percent efficiency could drop from the 80's to the 60's as the operation goes from continuous conduction mode to discontinuous conduction mode. Reference the ISL97701 data sheet for additional information on performance of the Boost Regulator.

4. To obtain output currents higher than 40mA, the user could:
  - Operate the circuit without the op amps (at the cost of output voltage regulation) by connecting directly to  $C_1$  and  $C_3$
  - Or replace the op amps with ones with higher output current drive capability
5. The accuracy of the output voltage is highly dependent on the input voltage source. Using a well regulated voltage source is recommended.

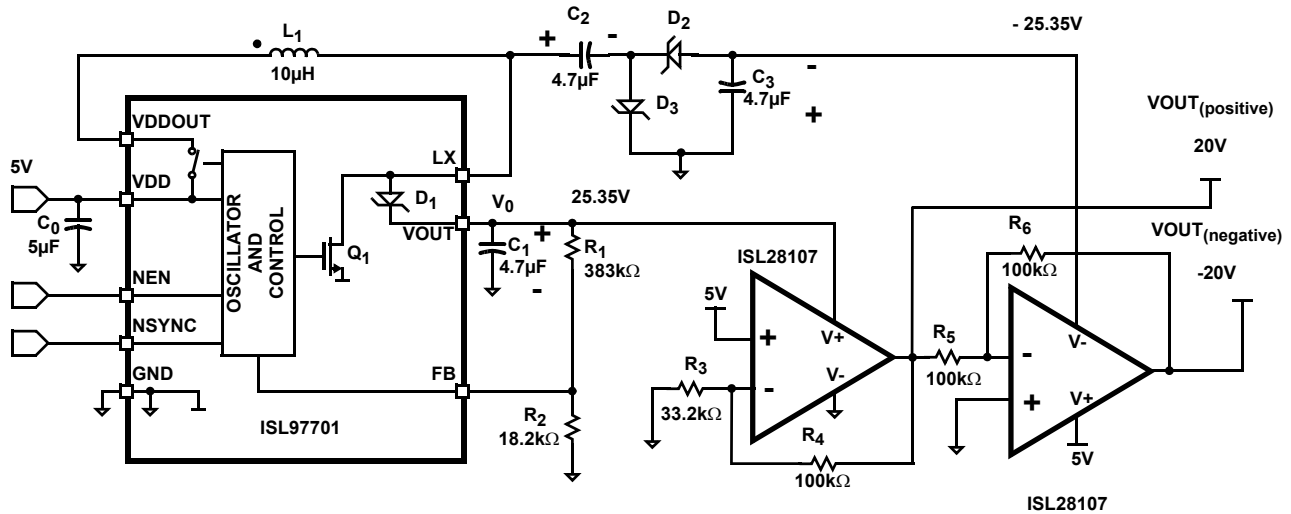

FIGURE 5. REFERENCE DESIGN TO GENERATE A POSITIVE AND NEGATIVE SUPPLY

## Notice

1. Descriptions of circuits, software and other related information in this document are provided only to illustrate the operation of semiconductor products and application examples. You are fully responsible for the incorporation or any other use of the circuits, software, and information in the design of your product or system. Renesas Electronics disclaims any and all liability for any losses and damages incurred by you or third parties arising from the use of these circuits, software, or information.
2. Renesas Electronics hereby expressly disclaims any warranties against and liability for infringement or any other claims involving patents, copyrights, or other intellectual property rights of third parties, by or arising from the use of Renesas Electronics products or technical information described in this document, including but not limited to, the product data, drawings, charts, programs, algorithms, and application examples.
3. No license, express, implied or otherwise, is granted hereby under any patents, copyrights or other intellectual property rights of Renesas Electronics or others.
4. You shall not alter, modify, copy, or reverse engineer any Renesas Electronics product, whether in whole or in part. Renesas Electronics disclaims any and all liability for any losses or damages incurred by you or third parties arising from such alteration, modification, copying or reverse engineering.
5. Renesas Electronics products are classified according to the following two quality grades: "Standard" and "High Quality". The intended applications for each Renesas Electronics product depends on the product's quality grade, as indicated below.  
"Standard": Computers; office equipment; communications equipment; test and measurement equipment; audio and visual equipment; home electronic appliances; machine tools; personal electronic equipment; industrial robots; etc.  
"High Quality": Transportation equipment (automobiles, trains, ships, etc.); traffic control (traffic lights); large-scale communication equipment; key financial terminal systems; safety control equipment; etc.  
Unless expressly designated as a high reliability product or a product for harsh environments in a Renesas Electronics data sheet or other Renesas Electronics document, Renesas Electronics products are not intended or authorized for use in products or systems that may pose a direct threat to human life or bodily injury (artificial life support devices or systems; surgical implantations; etc.), or may cause serious property damage (space system; undersea repeaters; nuclear power control systems; aircraft control systems; key plant systems; military equipment; etc.). Renesas Electronics disclaims any and all liability for any damages or losses incurred by you or any third parties arising from the use of any Renesas Electronics product that is inconsistent with any Renesas Electronics data sheet, user's manual or other Renesas Electronics document.
6. When using Renesas Electronics products, refer to the latest product information (data sheets, user's manuals, application notes, "General Notes for Handling and Using Semiconductor Devices" in the reliability handbook, etc.), and ensure that usage conditions are within the ranges specified by Renesas Electronics with respect to maximum ratings, operating power supply voltage range, heat dissipation characteristics, installation, etc. Renesas Electronics disclaims any and all liability for any malfunctions, failure or accident arising out of the use of Renesas Electronics products outside of such specified ranges.
7. Although Renesas Electronics endeavors to improve the quality and reliability of Renesas Electronics products, semiconductor products have specific characteristics, such as the occurrence of failure at a certain rate and malfunctions under certain use conditions. Unless designated as a high reliability product or a product for harsh environments in a Renesas Electronics data sheet or other Renesas Electronics document, Renesas Electronics products are not subject to radiation resistance design. You are responsible for implementing safety measures to guard against the possibility of bodily injury, injury or damage caused by fire, and/or danger to the public in the event of a failure or malfunction of Renesas Electronics products, such as safety design for hardware and software, including but not limited to redundancy, fire control and malfunction prevention, appropriate treatment for aging degradation or any other appropriate measures. Because the evaluation of microcomputer software alone is very difficult and impractical, you are responsible for evaluating the safety of the final products or systems manufactured by you.
8. Please contact a Renesas Electronics sales office for details as to environmental matters such as the environmental compatibility of each Renesas Electronics product. You are responsible for carefully and sufficiently investigating applicable laws and regulations that regulate the inclusion or use of controlled substances, including without limitation, the EU RoHS Directive, and using Renesas Electronics products in compliance with all these applicable laws and regulations. Renesas Electronics disclaims any and all liability for damages or losses occurring as a result of your noncompliance with applicable laws and regulations.
9. Renesas Electronics products and technologies shall not be used for or incorporated into any products or systems whose manufacture, use, or sale is prohibited under any applicable domestic or foreign laws or regulations. You shall comply with any applicable export control laws and regulations promulgated and administered by the governments of any countries asserting jurisdiction over the parties or transactions.
10. It is the responsibility of the buyer or distributor of Renesas Electronics products, or any other party who distributes, disposes of, or otherwise sells or transfers the product to a third party, to notify such third party in advance of the contents and conditions set forth in this document.
11. This document shall not be reprinted, reproduced or duplicated in any form, in whole or in part, without prior written consent of Renesas Electronics.
12. Please contact a Renesas Electronics sales office if you have any questions regarding the information contained in this document or Renesas Electronics products.  
(Note 1) "Renesas Electronics" as used in this document means Renesas Electronics Corporation and also includes its directly or indirectly controlled subsidiaries.  
(Note 2) "Renesas Electronics product(s)" means any product developed or manufactured by or for Renesas Electronics.

(Rev.4.0-1 November 2017)



### SALES OFFICES

Renesas Electronics Corporation

<http://www.renesas.com>

Refer to "<http://www.renesas.com/>" for the latest and detailed information.

**Renesas Electronics America Inc.**  
1001 Murphy Ranch Road, Milpitas, CA 95035, U.S.A.  
Tel: +1-408-432-8888, Fax: +1-408-434-5351

**Renesas Electronics Canada Limited**  
9251 Yonge Street, Suite 8309 Richmond Hill, Ontario Canada L4C 9T3  
Tel: +1-905-237-2004

**Renesas Electronics Europe Limited**  
Dukes Meadow, Millboard Road, Bourne End, Buckinghamshire, SL8 5FH, U.K.  
Tel: +44-1628-651-700, Fax: +44-1628-651-804

**Renesas Electronics Europe GmbH**  
Arcadiastrasse 10, 40472 Düsseldorf, Germany  
Tel: +49-211-6503-0, Fax: +49-211-6503-1327

**Renesas Electronics (China) Co., Ltd.**  
Room 1709 Quantum Plaza, No.27 ZhichunLu, Haidian District, Beijing, 100191 P. R. China  
Tel: +86-10-8235-1155, Fax: +86-10-8235-7679

**Renesas Electronics (Shanghai) Co., Ltd.**  
Unit 301, Tower A, Central Towers, 555 Langao Road, Putuo District, Shanghai, 200333 P. R. China  
Tel: +86-21-2226-0888, Fax: +86-21-2226-0999

**Renesas Electronics Hong Kong Limited**  
Unit 1601-1611, 16/F., Tower 2, Grand Century Place, 193 Prince Edward Road West, Mongkok, Kowloon, Hong Kong  
Tel: +852-2265-6688, Fax: +852-2886-9022

**Renesas Electronics Taiwan Co., Ltd.**  
13F, No. 363, Fu Shing North Road, Taipei 10543, Taiwan  
Tel: +886-2-8175-9600, Fax: +886-2-8175-9670

**Renesas Electronics Singapore Pte. Ltd.**  
80 Bendemeer Road, Unit #06-02 Hyflux Innovation Centre, Singapore 339949  
Tel: +65-6213-0200, Fax: +65-6213-0300

**Renesas Electronics Malaysia Sdn.Bhd.**  
Unit 1207, Block B, Menara Amcorp, Amcorp Trade Centre, No. 18, Jln Persiaran Barat, 46050 Petaling Jaya, Selangor Darul Ehsan, Malaysia  
Tel: +60-3-7955-9390, Fax: +60-3-7955-9510

**Renesas Electronics India Pvt. Ltd.**  
No.777C, 100 Feet Road, HAL 2nd Stage, Indiranagar, Bangalore 560 038, India  
Tel: +91-80-67208700, Fax: +91-80-67208777

**Renesas Electronics Korea Co., Ltd.**  
17F, KAMCO Yangjae Tower, 262, Gangnam-daero, Gangnam-gu, Seoul, 06265 Korea  
Tel: +82-2-558-3737, Fax: +82-2-558-5338