

RYZ014

Power Consumption Measurements on RYZ014-Based Modules

Contents

1. Introduction.....	2
1.1 RYZ014 Platform Power States	2
1.2 RRC Idle Mode with or without PSM	3
1.2.1 RRC Idle Mode	3
1.2.2 PSM.....	4
2. Setup.....	5
2.1 List of Required Equipment	5
2.2 Setup Overview	5
2.3 Modem Basic Settings.....	5
2.3.1 Checking Modem Boot Up and AT Channel	5
2.3.2 Checking Attach	6
2.3.3 Checking Signal Conditions	7
2.3.4 Modem Wake Sources	7
2.3.5 Timers Configuration	7
2.3.6 Get URCS	8
3. Power Measurement Use Cases	8
3.1 Boot with CFUN=0.....	8
3.2 PSM Mode.....	10
3.2.1 Setting PSM Timers	10
3.2.2 Test Procedure with UDP Traffic.....	10
3.2.3 PSM and cDRX	12
3.2.4 Tracking Area Update	12
3.2.5 PSM and TCP Traffic	13
3.3 Troubleshooting Check List.....	13
4. Abbreviations.....	14
5. Appendix A – Power Monitor Tools.....	14
Revision History.....	15

1. Introduction

This manual is intended to help end users of Renesas' solutions to evaluate the power consumption of RYZ014 (LTE-M) module.

It is used as a guide to configure the software and run the tests on the live network to achieve the expected power consumption numbers in active transmission, RRC Idle Mode and PSM. ePSM is a new protocol introduced by LTE Releases 12 and 13 for the User Equipment (UE) in RRC Idle Mode and which can bring dramatic improvements on the power consumption.

The prerequisite for using this document is that the setup is ready to measure power consumption. Please refer to the power consumption section of the user manual of the Evaluation Kit that you are using to identify the required operations and prepare the setup for power measurement.

1.1 RYZ014 Platform Power States

RYZ014 platform supports several power states. The following table shows the various modes and the corresponding wake-up latency values.

Mode	Wake-up latency
Deep sleep	< 2 secs
Sleep	< 15 ms
Standby	< 1 ms
Modem active	< 1 ms

When the platform is in Sleep mode or Deep Sleep mode, UARTs become unresponsive.

The host MCU can know if the RYZ014 platform is in Sleep mode or Deep Sleep mode by checking the PS-STATUS line of the platform. The line toggles as follows:

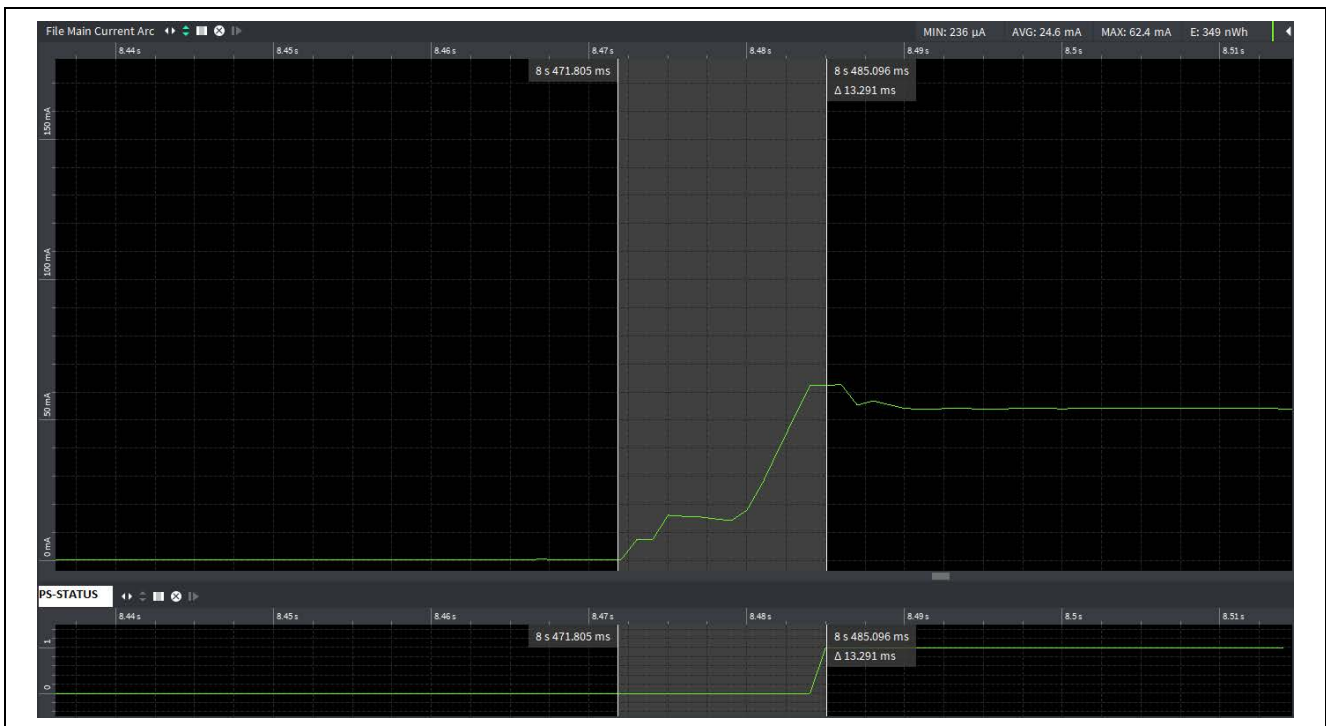

Figure 1. From Sleep Mode

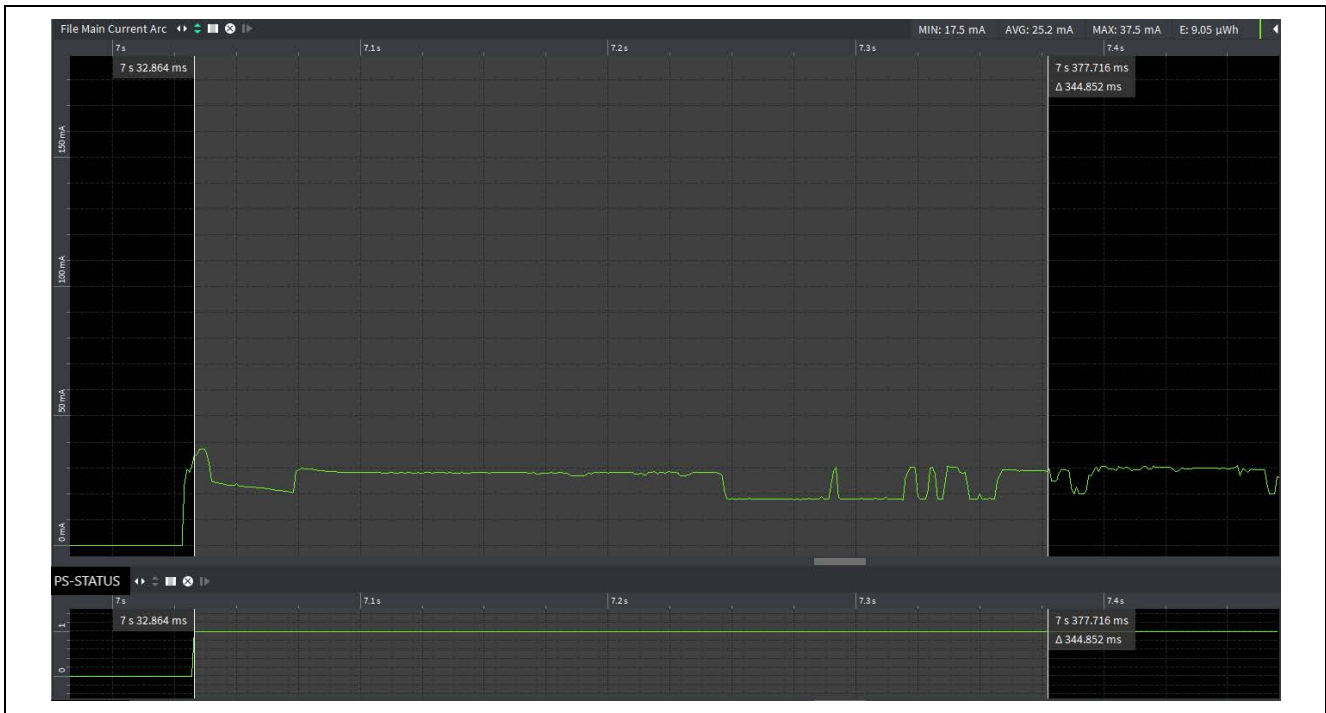

Figure 2. From Deep Sleep Mode

Please refer to the *RYZ014 System Integration Guide* for more details.

For the platform to be able to enter Sleep or Deep Sleep modes, several conditions need to be fulfilled:

- No data or URC in UARTs buffers
- No wake source enabled
- Network connection released (RRC connection release message received from the network)

1.2 RRC Idle Mode with or without PSM

Once the UE is attached to the eNB and registered in the network, when it has no more data to receive or transmit, the eNB sends an RRC Connection Release message. After this message, the UE changes its RRC state from Connected to Idle Mode. The time between the last message sent from the UE and the transmission of the RRC Connection Release message depends on the settings of the network (inactivity timer value).

This section provides an overview of the differences between the available protocols and how they can bring a significant benefit on the power consumption while in stand-by.

1.2.1 RRC Idle Mode

When in RRC Idle Mode without PSM activated, the UE listens for a paging message every paging cycle. The UE is reachable at every paging opportunity. The paging cycle configuration is network dependent; the maximum value is 2.56 seconds and it is usually set to 1.28 seconds.

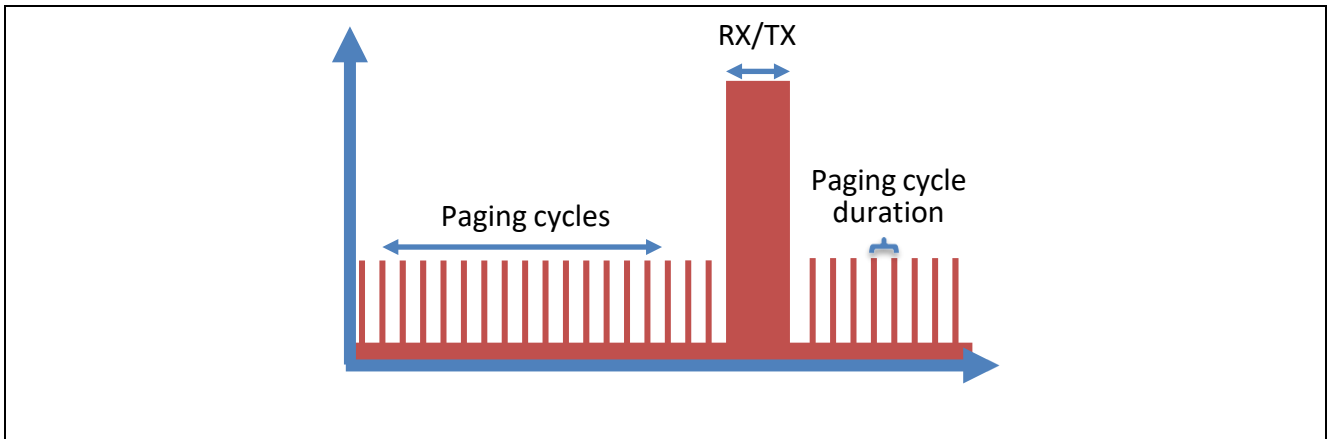

Figure 3. Paging Cycles

Between each paging opportunity, the RYZ014 platform will be in platform light sleep mode consuming around 200 μ A.

The power consumption for a paging cycle at 1.28 seconds is around 7.5 mW and it lowers to 5.5 mW for a paging cycle at 2.56 seconds.

1.2.2 PSM

In Power Saving Mode (PSM), the UE monitors paging cycles during a specific time interval. The UE can stay dormant for very long periods, up to 310 hours or 12 days.

PSM is activated by UE by including two timer values in the NAS Attach Request message or the Tracking Area Update (TAU).

The first timer, named T3324, defines the time the UE should stay active after Idle Mode following the Attach or TAU procedure. T3324 is a timer which determines for how long the UE will monitor paging before entering in PSM sleep state.

The second timer, called extended T3412, defines the extended time for a UE to perform periodic TAU procedures.

The difference between these timers (T3412 - T3324) is the PSM sleep time.

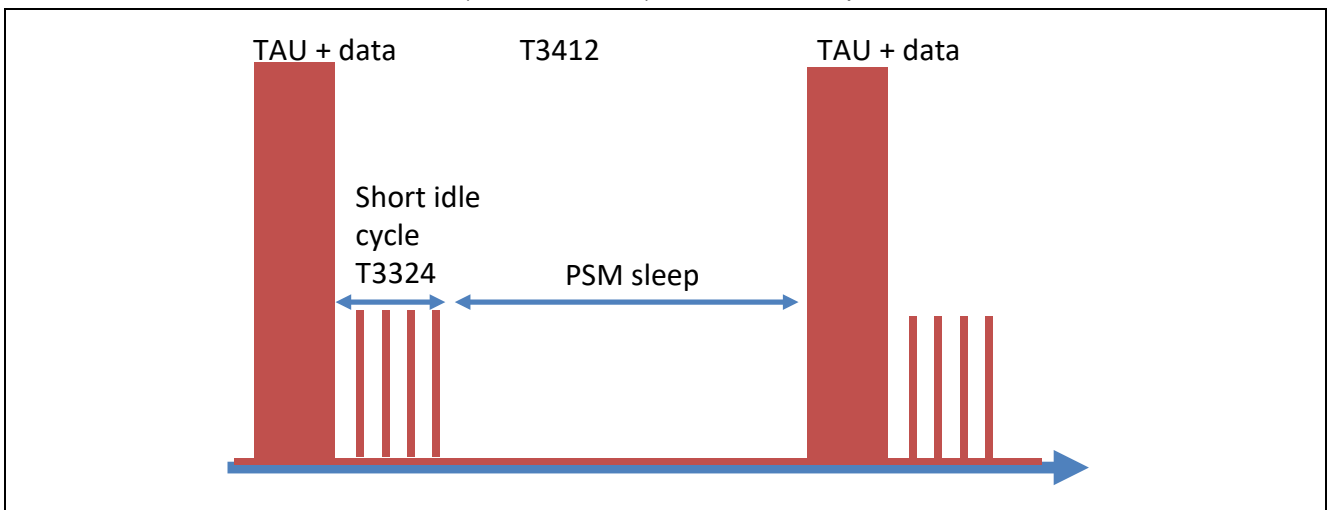

Figure 4. Power Saving Mode Cycles

The RYZ014 platform will enter Deep Sleep mode while the UE is in PSM sleep state if no wake lock is activated and no data/URC are buffered on the AT UARTs.

2. Setup

2.1 List of Required Equipment

The following is the list of required hardware equipment:

- EVK: standalone cellular modem board based on Renesas RYZ014 module
- USB-mini cables
- USIM, 3FF micro size
- LTE tester such as CMW500 or Anritsu MD8430A simulator with 1 RF cable if you do not have access to a live LTE-M network
- A 3.8-V lab power supply and power analyzer. It can be the same equipment (for example, OTII Power Monitor from Qoitech) or two separate equipment. The required accuracy of the ampere meter should allow current measurements as low as 1 μ A. We assume that you are using a single equipment for the power supply and the analyzer / ampere for your tests throughout this document. Appendix A – Power Monitor Tools provides some equipment overview.
- Windows® PC (laptop)

2.2 Setup Overview

Please refer to the power consumption section of the EVK user manual that you are using for the setup preparation.

The following diagram shows a high-level view of the connections between the different equipment of the setup with the RYZ014AAA EVK of the RYZ014 module. The RYZ014AAA EVK was chosen as an example. The same setup can be replicated with any of the RYZ014 module's EVK by following the instructions given in the relevant EVK user manual.

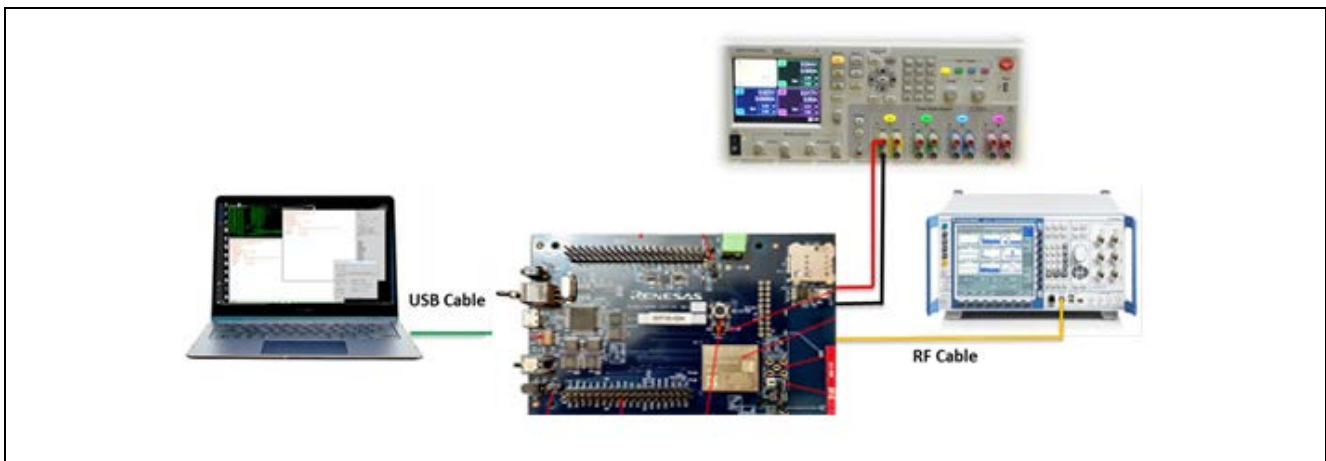

Figure 5. RYZ014AAA EVK Setup

2.3 Modem Basic Settings

Low power is activated by default on the software.

2.3.1 Checking Modem Boot Up and AT Channel

First, check that the EVK is connected to the PC. Make sure to open Tera Term windows on both the main AT command UART and the console UART (please refer to the EVK user manual to perform this step).

Then, apply 3V8 power supply to the RYZ014 module.

Note: Although the device is powered by an external power supply, make sure to connect the USB cable to your PC, to maintain the FTDI chip (Serial-USB converter) of the EVK at a correct level, allowing the chipset to enter Low Power Mode.

Once a voltage of 3.8 V is applied to the RYZ014 module from the power monitor, you should see the modem boot-up logs displayed in the console UART as follows:

```

[0000000000] boot: Switched to flash, timeout 100
[0000000000] Running on Windbond flash sector 0x1
[0000000000] RBGerbil 11.11@46595 '5.4.1.0 [46595
[0000000001] Reset cause 'EXT'(real 'EXT' ) <boot
1
[0000000002] regConfig 0x6016C894E1
[0000000002] boot: Current flash, timeout 10000,
[0000000003] boot: FFF mode
[0000000179] elf: ELF format selected
[0000000179] elf: Header finished
[0000000179] elf: Waiting for 480 bytes
[0000000180] elf: PH 0x002A8BE0, 28 bytes
[0000000180] elf: Note 0x63727A04
[0000000181] elf: PH 0x00000000, 20 bytes
[0000000181] elf: Note 0x4D415000
[0000000182] elf: PH 0x00001000, 92 bytes
[0000000182] elf: PH 0x00001060, 2080 bytes
[0000000183] elf: PH 0x00001880, 110096 bytes
[0000000186] elf: PH 0x0001C690, 8 bytes
[0000000187] elf: PH 0x0001C698, 56 bytes
[0000000187] elf: PH 0x0001C6D0, 100 bytes
[0000000187] elf: PH 0x0001C734, 576 bytes
[0000000188] elf: PH 0x0001C974, 2676 bytes
[0000000189] elf: PH 0x002A8B00, 32 bytes
[0000000189] elf: PH 0x00710000, 192552 bytes
[0000000195] elf: PH 0x00750000, 124184 bytes
[0000000199] elf: PH 0x007A0000, 327360 bytes
[0000000208] elf: PH 0x002A9000, 8192 bytes
[0000000209] elf: Program Header finished
[0000000209] sbp: Booting at 0x1C100340...
eem: Resuming...
fs: Mounting /flash0...done
fs: Overlay filesystem mounted on /fs
>INFO> DCP : Init over='serial'
[PSP] initializing
fs: Mounting upgrade filesystem ...
fs: Mounting done
QKI pools init...done

```

Figure 6. Modem Bootup Log

On AT UART you should see +SYSSTART printed out.

Then, send the following AT commands to check that the modem can answer AT command and enable local echo. Both commands should return "OK".

- AT
- ATE1

2.3.2 Checking Attach

Before starting power measurements, we recommend to first check that the modem can attach to the eNB and that IP connectivity is up with AT+PING.

If you connect to a public network or if you are using an eNodeB simulator that can access the internet, you can use for example AT+PING="www.renesas.com".

In this document, we assume that the SIM is unlocked and SIM PIN is disabled. If not, use AT+CPIN command to enter the PIN code.

Note: The SIM which supports Rel-13 UICC deactivation feature is not required to perform the tests described in this document.

Once the attachment is verified, we recommend disabling the +CEREG URC (Unsolicited Result Code) with AT+CEREG=0, so that unexpected URC will not prevent the platform from entering sleep or deep sleep modes. Doing so is fully acceptable for a test using the EVK with a laptop as it is difficult to monitor the incoming URC. For the final product, CEREGR URC should not be disabled. These URCs are very useful for the host application to track if there are any network connectivity issues. The RING line will toggle for any incoming URC or data, warning the host application that the UART buffer needs to be flushed so that the modem can go back to sleep.

If you would like to avoid disabling CEREGR URCs and monitor them or any other URCs while performing power consumption measurements, please refer to section 2.3.6.

2.3.3 Checking Signal Conditions

Signal conditions at the UE location can have a significant impact on the performances of the modem regarding the power consumption. In particular, the following values should be checked: RSRP (signal strength), RSRQ (signal quality) and CINR (Carrier to Interference and Noise Ratio).

Before starting power measurement tests, we recommend finding a test spot with a good quality of signal, so that the measurements shown in this user guide could be reproduced.

The following table gives some guidance to estimate the signal condition and should not be taken as an absolute rule.

Signal condition	Signal Strength	Signal quality
Good signal	RSRP > -90 dBm	CINR > 10 dB
Average Signal	-110 dBm < RSRP < -90 dBm	0 dB < CINR < 10 dB
Bad Signal	RSRP < -110 dBm	CINR < 0 dB

The following AT commands can be used to monitor the signal level and quality:

- AT+CESQ
- AT+SQNMONI=9

2.3.4 Modem Wake Sources

The modem can be configured with 4 different external wake sources: RTS0, RTS1, Wake0 and Wake1. These wake sources are used to wake the modem up from low power mode. When enabled and active, the wake sources will also prevent the modem from going into low power mode. It is possible to check the current wake source configuration, enable/disable them with AT+SQNHWCFCG command while in manufacturing mode (AT+CFUN=5). Please refer to the *Use cases with AT commands* document for more details on the usage of this command.

Depending on the EVK that you are using, the default wake sources are RTS0 only or RTS0 and RTS1. We strongly recommend that you define the RTS line of the main UART as the only wake source for these manual power consumption tests. It is also necessary to keep the main UART as the only UART configured with the AT function. If other UARTs are configured as AT UARTs, they will get the URC from the modem and will prevent the platform from entering low power modes if URCs are not cleared.

2.3.5 Timers Configuration

The power consumption figures can be affected by different timers: the UART inactivity timer, the authorized wake-up latency, and the ring line duration.

The UART inactivity time represents the guard period between the last character received on the UART and the moment the module will be authorized to enter low power mode. The default value is 5000 ms and it can be lowered down to 100 ms using the AT+SQNIPSCFCG command. The first parameter of this command should never be changed and be set to 1: AT+SQNIPSCFCG=1, 100.

As long as the UART inactivity timer has not expired, the module will not enter low power mode even though all the other conditions are fulfilled. Once the UART inactivity timer is expired, the module can enter low power as long as all conditions are fulfilled.

The authorized wake-up latency is the time duration that the module can take to come back to operational mode whenever the host MCU needs access to modem services. Coming back to operational mode from deep sleep mode will take more time than from sleep mode. The module will decide autonomously the deepest low power mode it can use as long as its latency is acceptable for the host. Configuring a maximum latency below 4 seconds will typically prevent the module from entering suspend mode. The default value for this latency is 5000 ms and can be changed with the AT+SQNPSCFCG command.

The ring line will toggle whenever URC or data are received. The ring duration can be configured using the AT+SQNRICFCG command. The duration is set to 5 seconds by default and can be lowered down to 1 second. Note that the modem platform will remain active during all the time the ring line is asserted. The same AT command will allow you to deactivate the ring line or make it toggle only on data or only on URC reception.

2.3.6 Get URCs

The platform will not enter low power if any data or URC are stuck in UART buffers. Therefore, it is important to ensure that no URCs are stuck in the modem AT UART buffers.

By default, flow control is activated on the main AT UART. As explained in section 2.3.4, the RTS line of this main UART is configured as a wake source by default. Therefore, to enable the modem to enter sleep modes, the RTS line needs to be cleared. Consequently, as flow control is activated, the modem will buffer data/URCs and will stay in active standby state until the RTS line is set again. On a final device, the host MCU would monitor the RING line to know when to set the RTS line. This cannot be easily done during manual tests. A solution is then to disable flow control support on modem side with `AT+IFC=0,0`.

With such a configuration, the modem will not buffer URCs or data when the RTS line is cleared. RTS line can then be used as a simple wake source.

With Tera Term version 4.94 or later, it is possible to clear/set the RTS line as follows:

1. First create two `.ttl` files in the teraterm folder:

- a. Create `clearrts.ttl` file:

```
; change flow control to "none"
setflowctrl 3

; RTS off
setrts 0
```

- b. Create `setrts.ttl` file:

```
; change flow control to none
setflowctrl 3

; RTS on
setrts 1
```

2. Then toggle the RTS line by selecting **Control -> Macro -> clearrts.ttl** or **Control -> Macro -> setrts.ttl**

3. Power Measurement Use Cases

This chapter describes how to conduct tests for evaluating the power consumption of RYZ014 modules in different use cases and how to analyze the power graph measurements.

3.1 Boot with CFUN=0

We recommend always starting power consumption measurements with this use case.

- Prerequisite
 - Prepare the setup as described in section 2
- Test procedure:
 - Apply power to the modem
 - Connect to the main AT UART and wait for the `+SYSSTART` URC to appear on the terminal
 - Connect to the debug console UART
 - Close/Disconnect all Tera term windows beside the console UART or toggle the RTS line of the main AT UART
 - Wait for a few seconds and check that when the modem is in deep sleep mode, the power consumption is around 1 μ A and you should see a log `eem: suspending...` on the console UART.

```

File Edit Setup Control Window Help
[FEEDS] : Init enter LWM2M
[FEEDS] : Init leave LWM2M
[FEEDS] : Init enter MQTT
[FEEDS] : Init leave MQTT
[FEEDS] : Init enter SQNSMS
[FEEDS] : Init leave SQNSMS
[FEEDS] : Init enter SUPL
[FEEDS] : Init leave SUPL

[PSPI] initialized
[PSPI] starting
reserved room 7/150
SLO started
::hell terminal::
-> [ZSP0] started after 2 ms, version 259.7
[ZSP1] started after 1 ms, version 257.6
LPU boot confirmation
[LIPI] started
HP: hpStart hpExitPromPsp=0
hp: Started
[FEEDS] : Start enter EAPPS
[FEEDS] : Start leave EAPPS
[FEEDS] : Start enter LWM2M
[FEEDS] : Start leave LWM2M
[FEEDS] : Start enter MQTT
[FEEDS] : Start leave MQTT
[FEEDS] : Start enter SQNSMS
[FEEDS] : Start leave SQNSMS
[FEEDS] : Start enter SUPL
[FEEDS] : Start leave SUPL

[PSPI] started
[hwid] Error: No pin for hwid1
sem: Suspending...
    
```

Figure 7. Power Consumption Log

- If not, see the troubleshooting section
- Figure 9 shows the power graph that you should get:



Figure 8. Power Graph in CFUN=0 Mode

- The UART inactivity timer is set to 5 seconds by default. It means that the UE will wait for 5 seconds after the Tera Term window is disconnected before going to Sleep or Deep Sleep mode. This timer can be lowered down to 100 ms with the `AT+SQNIPSCFG` command. See section 2.3.5.
- During the context saving phase the modem will save some specific configuration (operator mode, socket) before going to Deep Sleep mode. The phase duration will depend on the amount of data to be saved. The very first time the modem goes to Deep Sleep mode after boot, saving context will take more time than the next ones.

3.2 PSM Mode

3.2.1 Setting PSM Timers

Please refer to the PSM section of the *Use cases with AT command* document for more details.

PSM is disabled by default in the software. It can be activated with `AT+CPSMS`. This command also allows setting PSM timers.

Note that the timers set through the `AT+CPSMS` command can get rejected by the network. To verify the final configuration that was accepted by the network, you can activate CEREGR URC with `AT+CEREGR=4` before sending `AT+CFUN=1`.

PSM parameters values are detailed in 3GPP TS 24.008, Table 10.5.163a and 10.5.172:

- T3412-Extended is expressed as a string of a binary numbers encoded on 8 bits: 3 bits for the unit, 5 bits for the value.

xxx.....	000: Unit is 10 minutes
	001: Unit is 1 hour
	010: Unit is 10 hours
	011: Unit is 2 seconds
	100: Unit is 30 seconds
	101: Unit is 1 minute
111: Timer disabled	
...xxxxxx	Timer value, from 0 to 31

- T3324 encoding is expressed as a string of a binary numbers encoded on 8 bits: 3 bits for the unit, 5 bits for the value.

xxx.....	000: Unit is 2 seconds
	001: Unit is 1 minute
	010: Unit is 6 minutes
	111: Timer disabled
...xxxxxx	Timer value, from 0 to 31

For example, to set T3412-Extended to 120 hours and T3324 to 2 minutes, use:

```
AT+CPSMS=1,,, "01001100" , "00100010
```

For the sake of power saving, it is strongly recommended to set the value of T3412-Extended to a value higher than the duration between two wakeups of the platform by the external host application. A device in PSM should avoid waking- up as much as possible to perform TAU in order to get efficient power management.

3.2.2 Test Procedure with UDP Traffic

During this test, the UE will send a 1500 bytes UDP packet before entering PSM idle mode. You can replace the UDP packet sending by a simple ping with `AT+PING="www.renesas.com"` command.

- Prerequisite
 - Prepare the setup as described in section 2
 - Network supports PSM feature
 - Make sure to have access to a UDP server to check if packets are correctly received
- Test procedure:
 - Apply power to the modem
 - Connect to the main AT UART and wait for the +SYSSTART URC to appear on the terminal
 - Activate PSM with `AT+CPSMS=1,,, "10000110" , "00001000"`
 - T3324:16s, T3412-Extended: 3 min
 - Here T3412 is set to very small value to facilitate testing.
 - `AT+CEREGR=4`
 - `AT+CFUN=1`
 - Check that you received the CEREGR URC and that the timer settings are as expected
 - `+CEREGR: 1, "0002" , "01A2D004" , 7,,, "00001000" , "10000110"`

- Configure the UDP socket and send an UL packet with 1500 bytes
 - Refer to the *Use cases with AT command* document for more details on how to send the packet
 - Following is an example:

```
AT+SQNSCFG=1,1,0,90,600,50
AT+SQNSCFGEXT=1,0,0,0
AT+SQNSD=1,1,12345,"192.168.10.173",0,8000,1
AT+SQNSSENDEXT=1,1500
```

 - Send 1500 bytes to the server.
 - After the command, you would get a “>” before entering the data to be sent.
 - The AT wont exit until the configured length of data is received
- `AT+SQNSH=1`
- Close/Disconnect all Tera Term windows beside the console UART or toggle the RTS line of the main AT UART
- Wait for a few seconds and check that when the modem is in Deep Sleep mode, the power consumption is around 1 μ A. You should see a log `eem: suspending...` on the console UART
 - If not, please refer to the troubleshooting section
- Open the main AT UART again or toggle the RTS line of the main AT UART and send another UDP packet with:

```
AT+SQNSD=1,1,12345,"192.168.10.173",0,8000,1
```

 - Send a 1500 bytes packet to the server
- `AT+SQNSH=1`
- No need to configure the socket again there
- Close/Disconnect all Tera term windows beside the console UART or toggle the RTS line of the main AT UART
 - Wait for a few seconds and check that when the modem is in deep sleep mode, the power consumption is around 1 μ A. You should see a log `eem: suspending...` on the console UART
- The following is the power graph that you should get:

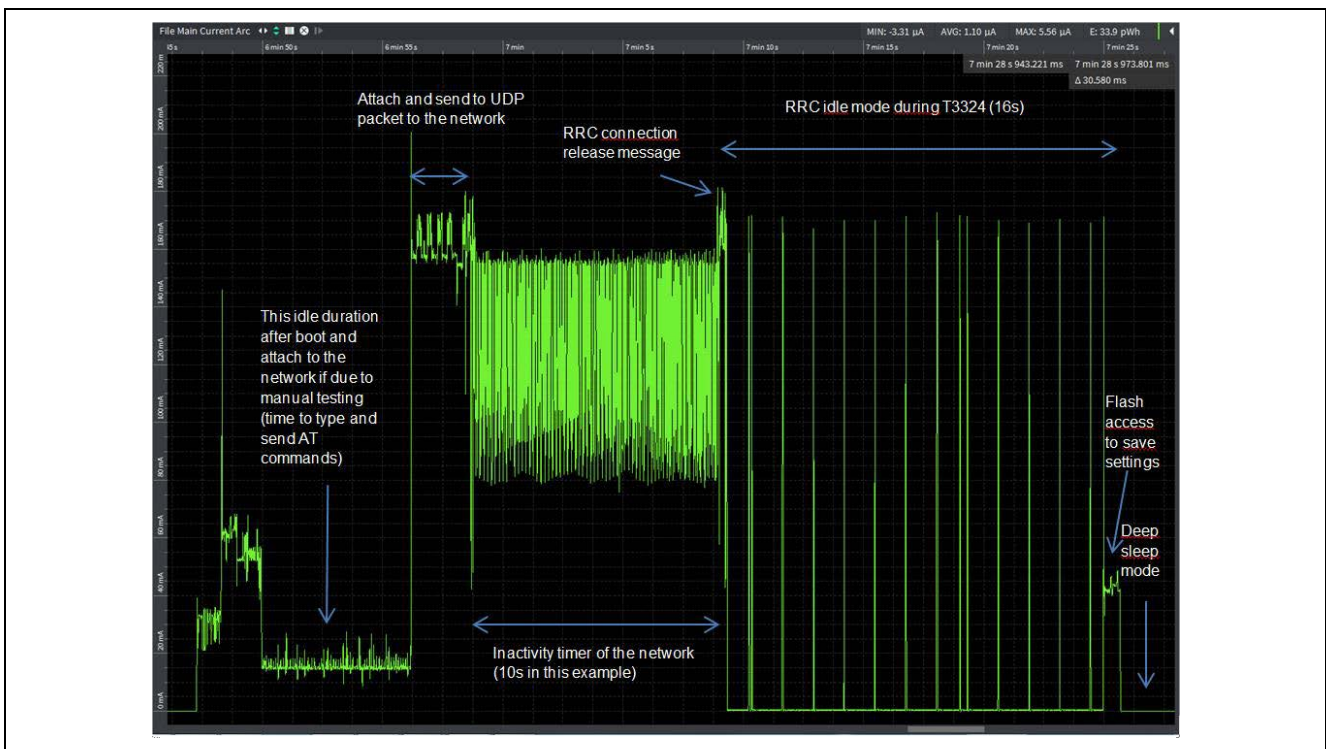

Figure 9. UDP Traffic Power Graph

- In the above example, the inactivity timer was set to 10 seconds on the network side
- During the duration of the inactivity timer, the UE consumes around 150 mA, so the final power consumption figure is highly dependent on this parameter that is specific to the network.

3.2.3 PSM and cDRX

On some networks, the inactivity timer is set around 10 to 20 seconds. In that case, the support of cDRX feature can be useful to lower the power consumption during this phase. RYZ014 module support cDRX feature, it has to be activated on the network side as well.

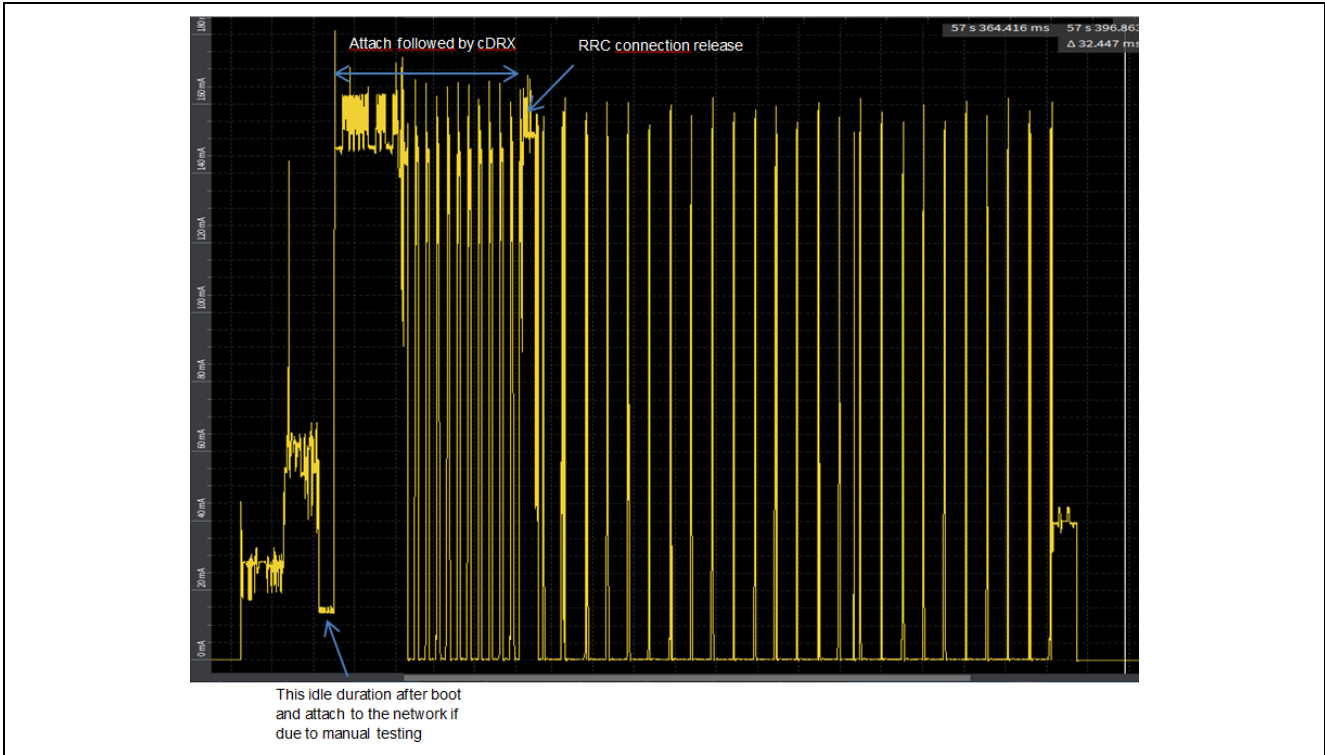

Figure 10. Power Graph in cDRX

3.2.4 Tracking Area Update

Once in PSM Idle, the UE will only wake up if the host MCU toggles a wake GPIO or to perform a tracking area update. The TAU settings (T3412-Extended) should be such that the modem avoids as much as possible waking up to perform a TAU procedure. In the procedure described in 3.2.2, T3412-Extended is set to 3 minutes for testing purposes. Figure 12 is the power consumption graphs that you will get upon TAU.

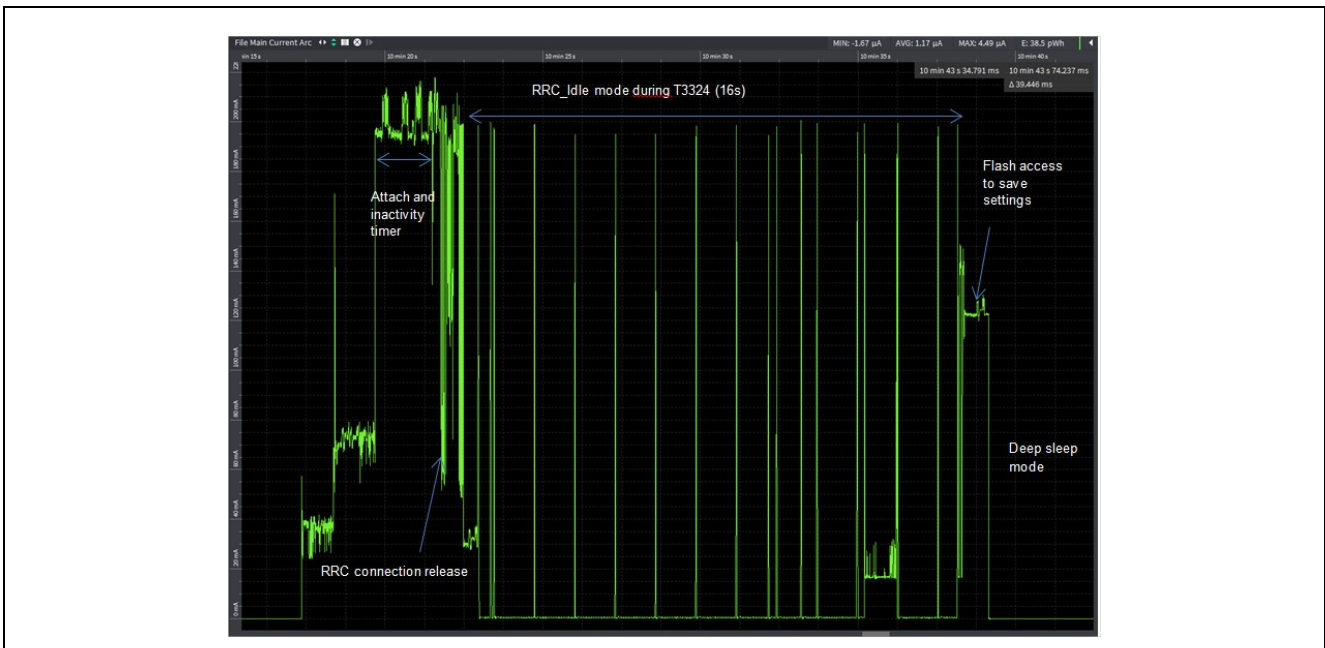

Figure 11. Tracking Area Update Power Consumption Graph

3.2.5 PSM and TCP Traffic

In the following example, the modem is sending TCP packets of 1 KB every 70 seconds. For each packet to be sent, the modem will boot up, send the TCP packet, wait for the RRC connection release message from the network (in this example the inactivity timer is 10 seconds). It will then stay in IDLE, listening to paging opportunities for the duration of the T3324 and finally enter deep sleep mode until the next TCP packet needs to be sent.

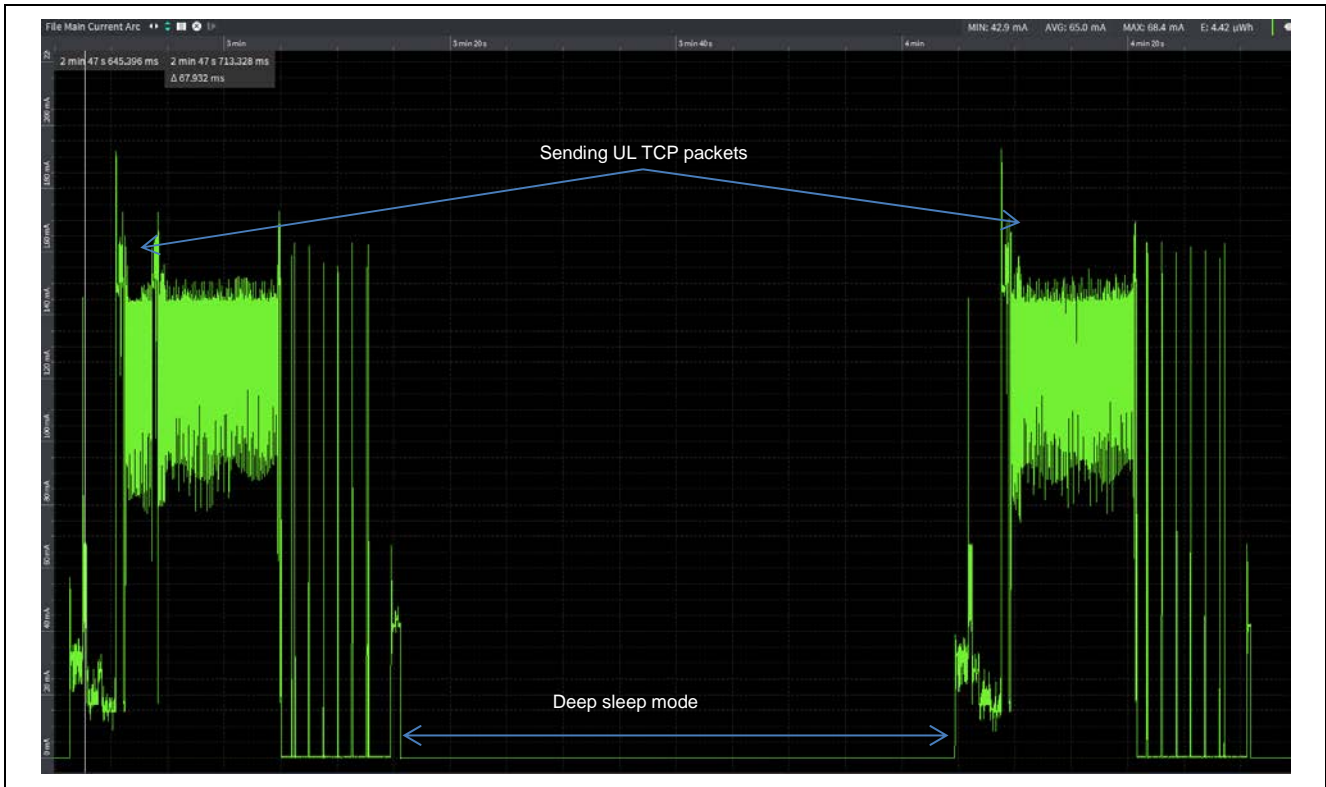

Figure 12. TCP Packet Traffic

3.3 Troubleshooting Check List

The modem cannot enter deep sleep mode if:

- RTS0 line is asserted
 - UART0 should be disconnected (Tera Term window closed/disconnected) to let the platform enter Deep Sleep mode
 - In general, make sure that only the debug console UART is connected when performing power consumption measurements
- Data is stuck in the UART buffer
 - Make sure to disconnect the UART0 only after receiving the CEREGR URC
 - You can disable CEREGR URC with `AT+CEREGR=0`
- SIM is waiting for a PIN code
 - Make sure that `AT+CPIN` returns READY after `AT+CFUN=1`

The UART inactivity timer is set to 5 seconds by default. It means that the UE will wait for 5 seconds after the Tera Term window is disconnected before going to sleep or deep sleep mode. This timer can be lowered down to 100 ms with the `AT+SQNIPSCFG` command.

When attached to the network, the power consumption is dependent on the inactivity timer and the cDRX configuration of the network. The UE cannot set any of these and needs to fully rely on the network for this.

Depending on the RSRP level at the location of the test, the UE may perform cell reselection or may have to monitor the RSRP level of neighbor cells, which will increase the power consumption. Make sure to have good RSRP level to reproduce the power consumption figures advertised in this document.

4. Abbreviations

AT command	Modem-type (Hayes) commands prefixed with AT characters.
LTE-M	LTE Category M
CINR	Carrier to Interference and Noise Ratio
eDRX	Extended Discontinuous Reception
EVK	Evaluation Kit
FW	Firmware
RYZ014	Renesas Cat M module platform name
NW	Network
PSM	Power Saving Mode
PTW	Paging Time Window
RSRP	Reference Signal Receive Power
RF	Radio Frequency
SMA	Type of RF connector
SIM	Subscriber Identity Module
Tera Term	A free terminal emulator software running on Windows PC and used to control the modem through AT commands
μA	micro Ampere
UE	User Equipment
URC	Unsolicited Result Code

5. Appendix A – Power Monitor Tools

- OTII Power Monitor from Qoitech (<https://www.qoitech.com>)
It can provide power and display power measurement on a graph with an accuracy of 1 μA.



- Keithley 2701 precision multimeter
It can be used in combination with a power monitor like the one from Monsoon, for accurately measuring very low current, around 1 μA, when the UE is in Deep Sleep mode.



- Keysight N6705B Power Analyzer
This is a lab power supply than can be used with separate Analyzer software on a PC. It can provide good accuracy for measuring current as low as 1 μA.



Revision History

Rev.	Date	Description	
		Page	Summary
1.00	Apr.12.21	-	Initial release
1.50	Mar.16.22	3-4, 9, 21-23, others	Updated figures Add section 2.3.5, Timers Configuration” Added PoLTE section. Other minor updates.
2.00	Oct. 26.22	-	Deleted eDRX and PoLTE

General Precautions in the Handling of Microprocessing Unit and Microcontroller Unit Products

The following usage notes are applicable to all Microprocessing unit and Microcontroller unit products from Renesas. For detailed usage notes on the products covered by this document, refer to the relevant sections of the document as well as any technical updates that have been issued for the products.

1. Precaution against Electrostatic Discharge (ESD)

A strong electrical field, when exposed to a CMOS device, can cause destruction of the gate oxide and ultimately degrade the device operation. Steps must be taken to stop the generation of static electricity as much as possible, and quickly dissipate it when it occurs. Environmental control must be adequate. When it is dry, a humidifier should be used. This is recommended to avoid using insulators that can easily build up static electricity.

Semiconductor devices must be stored and transported in an anti-static container, static shielding bag or conductive material. All test and measurement tools including work benches and floors must be grounded. The operator must also be grounded using a wrist strap. Semiconductor devices must not be touched with bare hands. Similar precautions must be taken for printed circuit boards with mounted semiconductor devices.

2. Processing at power-on

The state of the product is undefined at the time when power is supplied. The states of internal circuits in the LSI are indeterminate and the states of register settings and pins are undefined at the time when power is supplied. In a finished product where the reset signal is applied to the external reset pin, the states of pins are not guaranteed from the time when power is supplied until the reset process is completed. In a similar way, the states of pins in a product that is reset by an on-chip power-on reset function are not guaranteed from the time when power is supplied until the power reaches the level at which resetting is specified.

3. Input of signal during power-off state

Do not input signals or an I/O pull-up power supply while the device is powered off. The current injection that results from input of such a signal or I/O pull-up power supply may cause malfunction and the abnormal current that passes in the device at this time may cause degradation of internal elements. Follow the guideline for input signal during power-off state as described in your product documentation.

4. Handling of unused pins

Handle unused pins in accordance with the directions given under handling of unused pins in the manual. The input pins of CMOS products are generally in the high-impedance state. In operation with an unused pin in the open-circuit state, extra electromagnetic noise is induced in the vicinity of the LSI, an associated shoot-through current flows internally, and malfunctions occur due to the false recognition of the pin state as an input signal become possible.

5. Clock signals

After applying a reset, only release the reset line after the operating clock signal becomes stable. When switching the clock signal during program execution, wait until the target clock signal is stabilized. When the clock signal is generated with an external resonator or from an external oscillator during a reset, ensure that the reset line is only released after full stabilization of the clock signal. Additionally, when switching to a clock signal produced with an external resonator or by an external oscillator while program execution is in progress, wait until the target clock signal is stable.

6. Voltage application waveform at input pin

Waveform distortion due to input noise or a reflected wave may cause malfunction. If the input of the CMOS device stays in the area between V_{IL} (Max.) and V_{IH} (Min.) due to noise, for example, the device may malfunction. Take care to prevent chattering noise from entering the device when the input level is fixed, and also in the transition period when the input level passes through the area between V_{IL} (Max.) and V_{IH} (Min.).

7. Prohibition of access to reserved addresses

Access to reserved addresses is prohibited. The reserved addresses are provided for possible future expansion of functions. Do not access these addresses as the correct operation of the LSI is not guaranteed.

8. Differences between products

Before changing from one product to another, for example to a product with a different part number, confirm that the change will not lead to problems. The characteristics of a microprocessing unit or microcontroller unit products in the same group but having a different part number might differ in terms of internal memory capacity, layout pattern, and other factors, which can affect the ranges of electrical characteristics, such as characteristic values, operating margins, immunity to noise, and amount of radiated noise. When changing to a product with a different part number, implement a system-evaluation test for the given product.

Notice

1. Descriptions of circuits, software and other related information in this document are provided only to illustrate the operation of semiconductor products and application examples. You are fully responsible for the incorporation or any other use of the circuits, software, and information in the design of your product or system. Renesas Electronics disclaims any and all liability for any losses and damages incurred by you or third parties arising from the use of these circuits, software, or information.
 2. Renesas Electronics hereby expressly disclaims any warranties against and liability for infringement or any other claims involving patents, copyrights, or other intellectual property rights of third parties, by or arising from the use of Renesas Electronics products or technical information described in this document, including but not limited to, the product data, drawings, charts, programs, algorithms, and application examples.
 3. No license, express, implied or otherwise, is granted hereby under any patents, copyrights or other intellectual property rights of Renesas Electronics or others.
 4. You shall be responsible for determining what licenses are required from any third parties, and obtaining such licenses for the lawful import, export, manufacture, sales, utilization, distribution or other disposal of any products incorporating Renesas Electronics products, if required.
 5. You shall not alter, modify, copy, or reverse engineer any Renesas Electronics product, whether in whole or in part. Renesas Electronics disclaims any and all liability for any losses or damages incurred by you or third parties arising from such alteration, modification, copying or reverse engineering.
 6. Renesas Electronics products are classified according to the following two quality grades: "Standard" and "High Quality". The intended applications for each Renesas Electronics product depends on the product's quality grade, as indicated below.
 - "Standard": Computers; office equipment; communications equipment; test and measurement equipment; audio and visual equipment; home electronic appliances; machine tools; personal electronic equipment; industrial robots; etc.
 - "High Quality": Transportation equipment (automobiles, trains, ships, etc.); traffic control (traffic lights); large-scale communication equipment; key financial terminal systems; safety control equipment; etc.
- Unless expressly designated as a high reliability product or a product for harsh environments in a Renesas Electronics data sheet or other Renesas Electronics document, Renesas Electronics products are not intended or authorized for use in products or systems that may pose a direct threat to human life or bodily injury (artificial life support devices or systems; surgical implantations; etc.), or may cause serious property damage (space system; undersea repeaters; nuclear power control systems; aircraft control systems; key plant systems; military equipment; etc.). Renesas Electronics disclaims any and all liability for any damages or losses incurred by you or any third parties arising from the use of any Renesas Electronics product that is inconsistent with any Renesas Electronics data sheet, user's manual or other Renesas Electronics document.
7. No semiconductor product is absolutely secure. Notwithstanding any security measures or features that may be implemented in Renesas Electronics hardware or software products, Renesas Electronics shall have absolutely no liability arising out of any vulnerability or security breach, including but not limited to any unauthorized access to or use of a Renesas Electronics product or a system that uses a Renesas Electronics product. RENESAS ELECTRONICS DOES NOT WARRANT OR GUARANTEE THAT RENESAS ELECTRONICS PRODUCTS, OR ANY SYSTEMS CREATED USING RENESAS ELECTRONICS PRODUCTS WILL BE INVULNERABLE OR FREE FROM CORRUPTION, ATTACK, VIRUSES, INTERFERENCE, HACKING, DATA LOSS OR THEFT, OR OTHER SECURITY INTRUSION ("Vulnerability Issues"). RENESAS ELECTRONICS DISCLAIMS ANY AND ALL RESPONSIBILITY OR LIABILITY ARISING FROM OR RELATED TO ANY VULNERABILITY ISSUES. FURTHERMORE, TO THE EXTENT PERMITTED BY APPLICABLE LAW, RENESAS ELECTRONICS DISCLAIMS ANY AND ALL WARRANTIES, EXPRESS OR IMPLIED, WITH RESPECT TO THIS DOCUMENT AND ANY RELATED OR ACCOMPANYING SOFTWARE OR HARDWARE, INCLUDING BUT NOT LIMITED TO THE IMPLIED WARRANTIES OF MERCHANTABILITY, OR FITNESS FOR A PARTICULAR PURPOSE.
 8. When using Renesas Electronics products, refer to the latest product information (data sheets, user's manuals, application notes, "General Notes for Handling and Using Semiconductor Devices" in the reliability handbook, etc.), and ensure that usage conditions are within the ranges specified by Renesas Electronics with respect to maximum ratings, operating power supply voltage range, heat dissipation characteristics, installation, etc. Renesas Electronics disclaims any and all liability for any malfunctions, failure or accident arising out of the use of Renesas Electronics products outside of such specified ranges.
 9. Although Renesas Electronics endeavors to improve the quality and reliability of Renesas Electronics products, semiconductor products have specific characteristics, such as the occurrence of failure at a certain rate and malfunctions under certain use conditions. Unless designated as a high reliability product or a product for harsh environments in a Renesas Electronics data sheet or other Renesas Electronics document, Renesas Electronics products are not subject to radiation resistance design. You are responsible for implementing safety measures to guard against the possibility of bodily injury, injury or damage caused by fire, and/or danger to the public in the event of a failure or malfunction of Renesas Electronics products, such as safety design for hardware and software, including but not limited to redundancy, fire control and malfunction prevention, appropriate treatment for aging degradation or any other appropriate measures. Because the evaluation of microcomputer software alone is very difficult and impractical, you are responsible for evaluating the safety of the final products or systems manufactured by you.
 10. Please contact a Renesas Electronics sales office for details as to environmental matters such as the environmental compatibility of each Renesas Electronics product. You are responsible for carefully and sufficiently investigating applicable laws and regulations that regulate the inclusion or use of controlled substances, including without limitation, the EU RoHS Directive, and using Renesas Electronics products in compliance with all these applicable laws and regulations. Renesas Electronics disclaims any and all liability for damages or losses occurring as a result of your noncompliance with applicable laws and regulations.
 11. Renesas Electronics products and technologies shall not be used for or incorporated into any products or systems whose manufacture, use, or sale is prohibited under any applicable domestic or foreign laws or regulations. You shall comply with any applicable export control laws and regulations promulgated and administered by the governments of any countries asserting jurisdiction over the parties or transactions.
 12. It is the responsibility of the buyer or distributor of Renesas Electronics products, or any other party who distributes, disposes of, or otherwise sells or transfers the product to a third party, to notify such third party in advance of the contents and conditions set forth in this document.
 13. This document shall not be reprinted, reproduced or duplicated in any form, in whole or in part, without prior written consent of Renesas Electronics.
 14. Please contact a Renesas Electronics sales office if you have any questions regarding the information contained in this document or Renesas Electronics products.

(Note1) "Renesas Electronics" as used in this document means Renesas Electronics Corporation and also includes its directly or indirectly controlled subsidiaries.

(Note2) "Renesas Electronics product(s)" means any product developed or manufactured by or for Renesas Electronics.

(Rev.5.0-1 October 2020)

Corporate Headquarters

TOYOSU FORESIA, 3-2-24 Toyosu,
Koto-ku, Tokyo 135-0061, Japan

www.renesas.com

Trademarks

Renesas and the Renesas logo are trademarks of Renesas Electronics Corporation. All trademarks and registered trademarks are the property of their respective owners.

Contact information

For further information on a product, technology, the most up-to-date version of a document, or your nearest sales office, please visit:

www.renesas.com/contact/.